

ORDINANCE NO. 4315

AN ORDINANCE OF THE COUNCIL OF THE CITY OF SCOTTSDALE, MARICOPA COUNTY, ARIZONA, TO AMEND THE CITY'S ZONING ORDINANCE (ORDINANCE NO. 455) ARTICLE VIII (SIGN REQUIREMENTS), FOR THE PURPOSES OF AMENDING AND UPDATING THE SIGN REGULATIONS FOR PERMANENT SIGNS, RELATED PROVISIONS, REQUIREMENTS, AND DEFINITIONS AND AS PROVIDED IN CASE NO. 1-TA-2017.

WHEREAS, the City of Scottsdale wishes to amend the Zoning Ordinance provisions regarding Article VIII. (Sign Requirements), for the purposes of amending and updating the sign regulations for permanent signs; and

WHEREAS, the Planning Commission held a public hearing on May 24, 2017; and

WHEREAS, the City Council held a public hearing on July 5, 2017 and considered a text amendment to the Zoning Ordinance of the City of Scottsdale, Case No.1-TA-2017; and

WHEREAS, the City Council has determined that the subject Zoning Ordinance amendment is in conformance with the General Plan.

BE IT ORDAINED by the Council of the City of Scottsdale as follows:

Section 1. That the Zoning Ordinance of the City of Scottsdale, is hereby amended as specified in that certain document entitled "1-TA-2017 Sign Ordinance Update – Permanent Signs," declared to be a public record by Resolution No. 10834 of the City of Scottsdale, and hereby referred to, adopted and made a part hereof as if fully set out in this Ordinance.

Section 2. If any section, subsection, sentence, clause, phrase or portion of this ordinance or any part of the code adopted herein is for any reason held to be invalid or unconstitutional by the decision of any court of competent jurisdiction, such decision shall not affect the validity of the remaining portions thereof.

PASSED AND ADOPTED by the City Council of the City of Scottsdale this 5th day of July, 2017.

CITY OF SCOTTSDALE, an
Arizona municipal corporation

ATTEST:

By: Carolyn Jagger
Carolyn Jagger, City Clerk

By: W. J. "Jim" Lane
W. J. "Jim" Lane, Mayor

APPROVED AS TO FORM:
OFFICE OF THE CITY ATTORNEY

Patricia Boomsma
Bruce Washburn, City Attorney

By: Patricia J. Boomsma, Assistant City Attorney

RESOLUTION NO. 10834

A RESOLUTION OF THE CITY COUNCIL OF THE CITY OF SCOTTSDALE, MARICOPA COUNTY, ARIZONA, DECLARING AS A PUBLIC RECORD THAT CERTAIN DOCUMENT FILED WITH THE CITY CLERK OF THE CITY OF SCOTTSDALE AND ENTITLED "1-TA-2017 – SIGN ORDINANCE UPDATE – PERMANENT SIGNS."

WHEREAS, State Law permits cities to declare documents a public record for the purpose of incorporation into city ordinances; and

WHEREAS, the City of Scottsdale wishes to incorporate by reference amendments to the Zoning Ordinance, Ordinance No. 455, by first declaring said amendments to be a public record.

NOW, THEREFORE BE IT RESOLVED, by the Council of the City of Scottsdale, Maricopa County, Arizona, as follows:

Section 1. That certain document entitled "1-TA-2017 – Sign Ordinance Update – Permanent Signs," attached as "Exhibit A", three copies of which are on file in the office of the City Clerk, is hereby declared to be a public record. Said copies are ordered to remain on file with the City Clerk for public use and inspection.

PASSED AND ADOPTED by the Council of the City of Scottsdale, Maricopa County, Arizona this 5th day of July, 2017.

ATTEST:

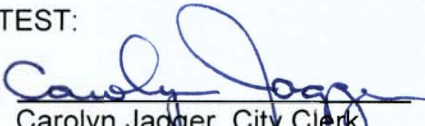
By: 
Carolyn Jagger, City Clerk

CITY OF SCOTTSDALE, an
Arizona municipal corporation

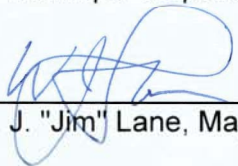
By: 
W. J. "Jim" Lane, Mayor

APPROVED AS TO FORM:

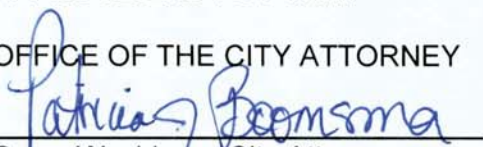
OFFICE OF THE CITY ATTORNEY

Bruce Washburn, City Attorney
By: Patricia J. Boomsma, Assistant City Attorney

ZONING ORDINANCE TEXT AMENDMENT

1-TA-2017

SIGN ORDINANCE UPDATE – PERMANENT SIGNS

HOW TO READ THIS DOCUMENT

Unless otherwise stated, provisions that are being deleted are shown with a strike-through, like this: ~~Provisions that are being deleted are shown with a strike-through.~~ Graphic that are being deleted are indicated with an “X” over the graphic.

Provisions that are being added are shown as highlighted, like this: **Provisions that are being added are shown as highlighted.**

Section 1. Repeal and replace Sec. 8.109. - Enforcement officer., as follows:

~~Sec. 8.109. – Enforcement officer.~~

~~The general manager shall have the authority to enforce this ordinance, and to make all inspections required to ensure such enforcement, and to hear appeals of all decisions relating to the *Uniform Building Code* and the *National Electrical Code*.~~

Sec. 8.109. – Reserved.

Section 2. Amend Section 8.200. – Definitions., to add the terms to the existing definitions in alphabetical order, to delete, and to amend existing definitions, as follows:

Sec. 8.200. - Definitions.

~~*Arterial (street)* **street.** Those lengths of streets so classified on the City of Scottsdale's ~~General Plan.~~ Shall mean the streets designated in the City's Transportation Master Plan with the classification of the Major Arterial and Minor Arterial.~~

***Address Sign* is a sign required by Chapter 31 and Chapter 36 of the Scottsdale Revised Code that identifies a building address numbers, building numbers or approved building identification.**

***Area of sign.* In the case of individual characters used as a sign, the area is ninety (90) percent of the area enclosed within the smallest regular geometric figure needed to completely encompass all characters of the sign, including horizontal spacing between characters, except as otherwise provided herein. For signs other than individual characters, the area is the smallest regular geometric figure needed to completely encompass the total area of a cabinet or panel, or the total area within the outer edge of a frame or other material, color, or condition utilized to create an outer border of the sign. The area of sign does not include address signs that are twelve (12) inches or less required by Chapters 31 and 36 of the Scottsdale Revised Code.**

~~For signs other than individual letters, words, insignias or symbols, the area is the total area of the facing or the total area within the outer edge of any existing border of the sign.~~

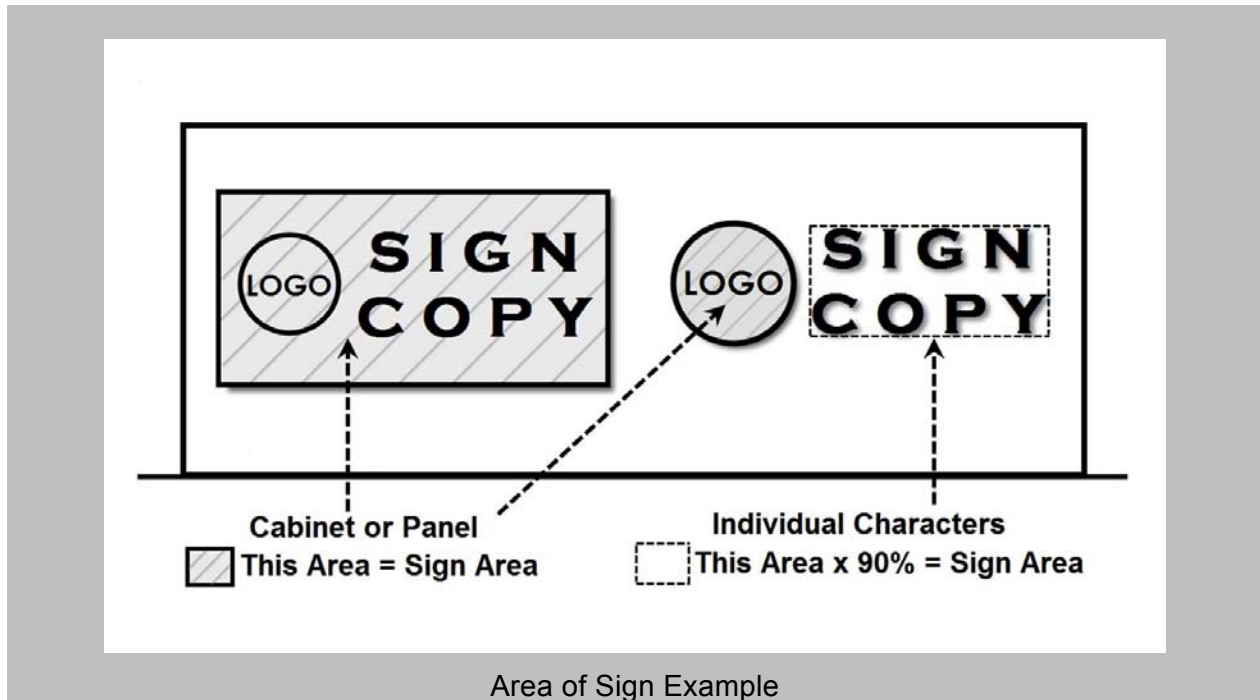
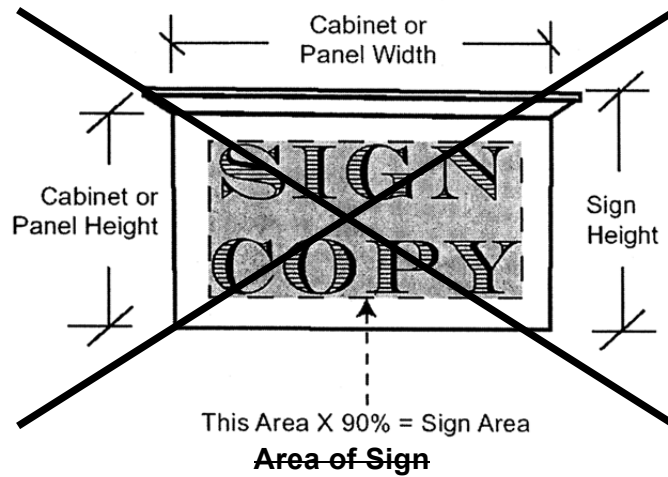

Automated teller machine directional sign. A traffic directional sign which is used to direct pedestrian or vehicular traffic on a parcel to the location of an automated teller machine.

Automated teller machine sign. Any sign located on or architecturally associated with the exterior face of an automated teller machine.

Building identification. The name of a building or of a tenant or occupants occupying at least thirty (30) percent of the building or sixty (60) percent of the first floor, which is placed on the building, or on a freestanding sign.

Building wall. The individual sides of a building.

Business entrance identification. A sign adjacent to, or on the entrance door of, a business containing the business name and such other appropriate information as store hours and telephone numbers.

Business front foot. The lineal distance measured along the exterior wall of the building space occupied by the business that the sign will be placed. The lineal distance of the building space occupied by the particular business measured on a straight line parallel to the street. Where a business does not parallel a street, the front foot shall be measured along the exterior of the building space occupied by the particular business.

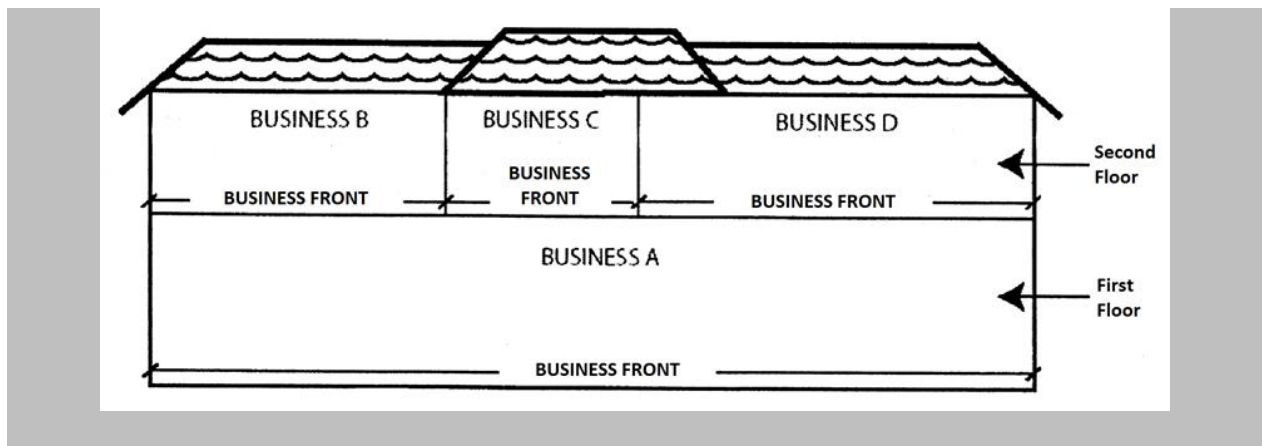
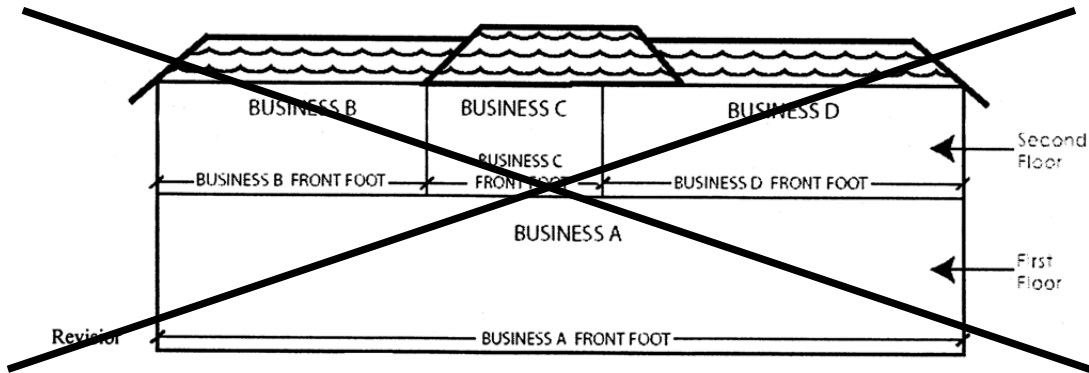

Business Front Foot

Business name. The name by which a business is commonly recognized and used by the applicant. The applicant shall provide stationery or other supporting documents illustrating the use of the business name or verification of the official business license or tax name. Slogans or product information shall not be considered as the business name.

Canopy Fascia Sign is a sign attached to the vertical front face of a canopy, roof overhang, covered walkway, covered porch, or purlin of an open lattice structure.

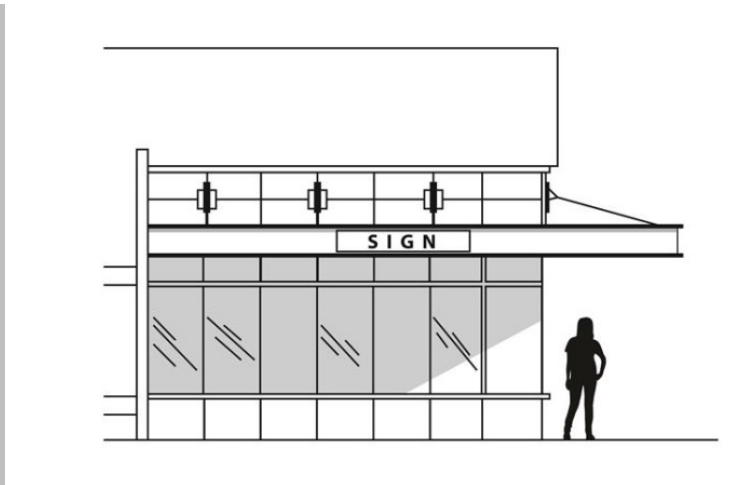

Canopy Fascia Sign Example

~~Change panel. A sign designed to permit immediate change of copy with language other than the name of the business.~~

~~Commercial district. A group or cluster of retail shops, offices or industrial buildings which share common parking, landscaping, and/or frontage, have a property owners association and have a name which is generally understood by the public to refer to the group or cluster.~~

~~Common building entrance. In a multitenant building, an entrance leading to a common lobby, atrium, patio and/or elevator foyer.~~

~~Community sign district. A group of businesses property owners in a specified area in the city which that have been organized into a coordinated group for the purpose of common signage and sign control.~~

~~Directory sign. A sign which provides a listing of the names of businesses, activities, addresses, locations, uses or places within a building or complex of buildings for the purpose of identification only.~~

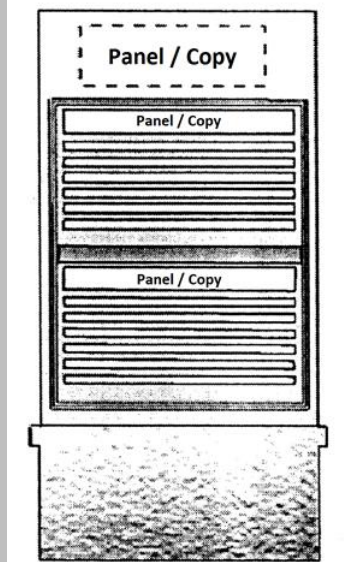

Directory Sign Example

Resolution No. 10834

Exhibit A

Page 4 of 28

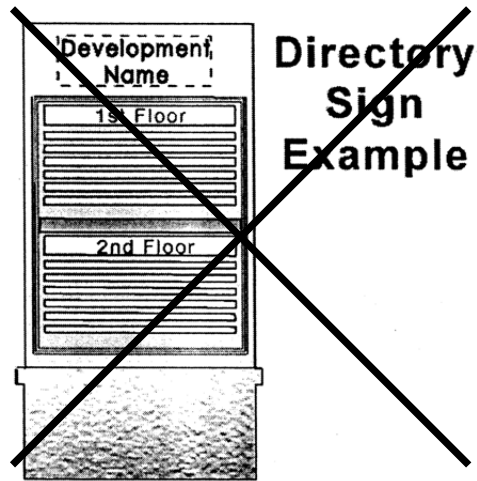

Drive-through sign is a freestanding sign adjacent to a drive-through.

Entry sign is a small sign located adjacent to a primary pedestrian entrance to a dwelling or suite.

Entryway monument sign is a freestanding cabinet or panel sign mounted on, or within a base (above grade), placed at the street or driveway leading into the development project.

Entryway sign-A is a freestanding sign which is placed on the a perimeter or screen wall of a development project, and adjacent to a street or driveway leading into the development project, having individual characters that may be mounted on, or integrated into, a panel. ~~recorded subdivision, townhouse project, commercial district, master planned community, hotel, motel or guest ranch at a major street or driveway entrance to identify the name of the interior project. Such signs may flank both sides of the entrance and may include ground or landscape wall sign types.~~

Fascia. A parapet type wall used as part of the face of a flat roofed building and projecting not more than six (6) feet from the building face immediately adjacent thereto. Such a wall shall enclose at least three (3) sides of the projecting flat roof and return to a parapet wall or the building.

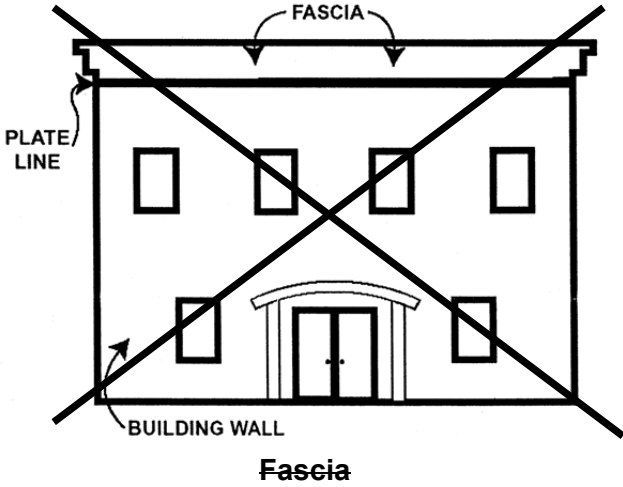

Freestanding canopy sign is a sign attached to the vertical front face of a freestanding canopy structure that is not attached to a building.

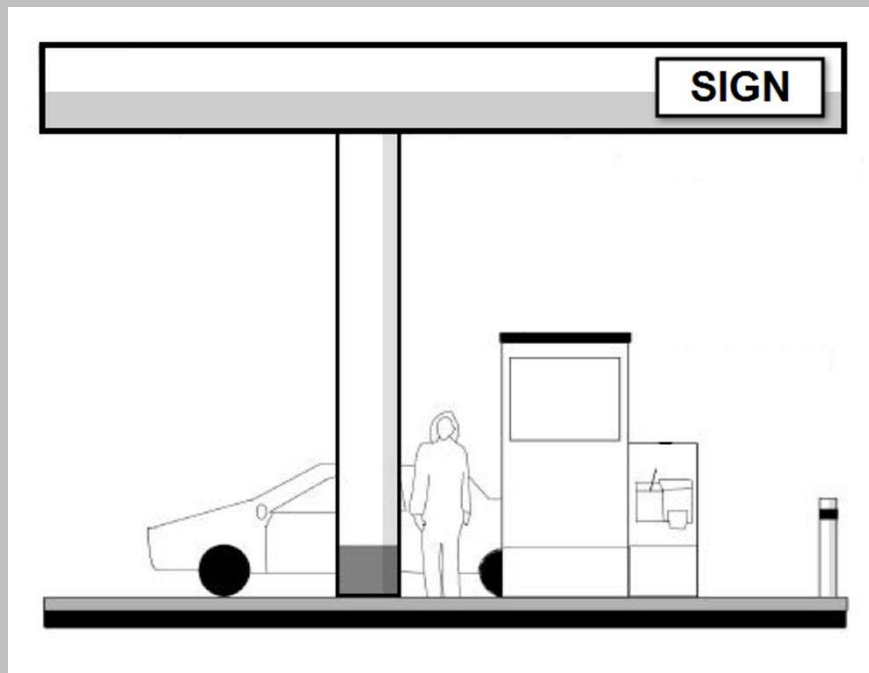

Freestanding Canopy Sign Example

~~*Fuel change panel price sign.* A sign used to identify the current price(s) of fuel as required by the state law Arizona Administrative Code.~~

~~*General manager.* The city's planning and zoning general manager or designee.~~

~~*Ground sign.* A freestanding sign that is architecturally integrated with the building with individually mounted letters and logos only. This sign shall be built with continuous background surface built from the ground up.~~

~~*Identification sign.* A building wall, landscape wall, ground sign or temporary sign used to present the name of a major residential project, master planned community or master planned community information center.~~

~~*Information center.* A facility in a master planned community which provides information, displays and guides for visitors in order to direct, to promote and sell projects within the master planned community.~~

~~*Landscape wall sign.* A freestanding sign architecturally integrated with the building, mounted on a screen or perimeter wall and having individual letters characters that may be mounted on, or integrated into, a panel. The sign is mounted on, or to, a wall, pole or base which may or may not be an attachment or extension of a building wall.~~

~~*Modifiers.* A word describing uses and activities other than the business name.~~

~~*Monument sign.* A freestanding cabinet or panel sign mounted on, or within a base (above grade), which is detached from any building.~~

Monument sign is a freestanding sign that may be a cabinet or panel mounted on, or integrated into, a background surface. Monument signs include individual characters that may be mounted on, or integrated into, a panel that is mounted on a background surface.

Multiple tenant commercial building. A commercial development in which there exists two or more separate commercial activities, in which there are appurtenant shared facilities (such as parking or pedestrian mall), and which is designed to provide a single area in which the public can obtain varied products and services. Distinguishing characteristics of a multiple tenant commercial building may, but need not, include common ownership of the real property upon which the center is located, common wall construction, and multiple occupant commercial use of a single structure.

Nameplate. A small sign which identifies a resident's or home's name and address or the name of a farm, ranch or commercial stable. Such signs may be shingle, building wall, or archway-mounted signs.

Occupancy. A purpose for which a building, or part thereof, is used or intended to be used.

Plate line. The point at which any part of the main roof structure first touches or bears upon an external wall.

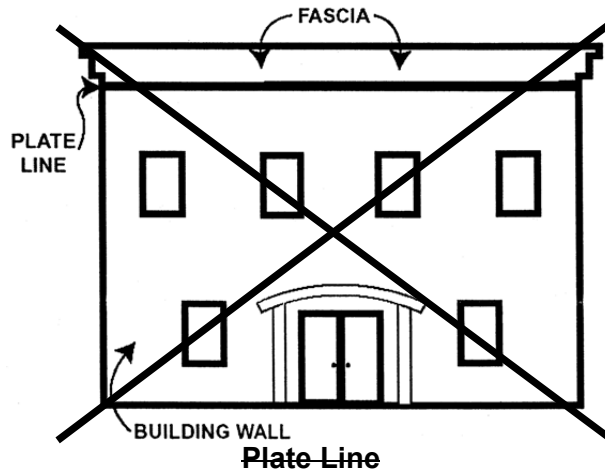

Projected building face. A calculation of the maximum lineal footage of the building front times the maximum height of the building.

Projected elevation area. The total area of the building face as projected to an imaginary plane parallel to the primary direction of the building face.

Purlin is a horizontal beam along the length of a canopy or trellis, resting on or supporting rafters or boards.

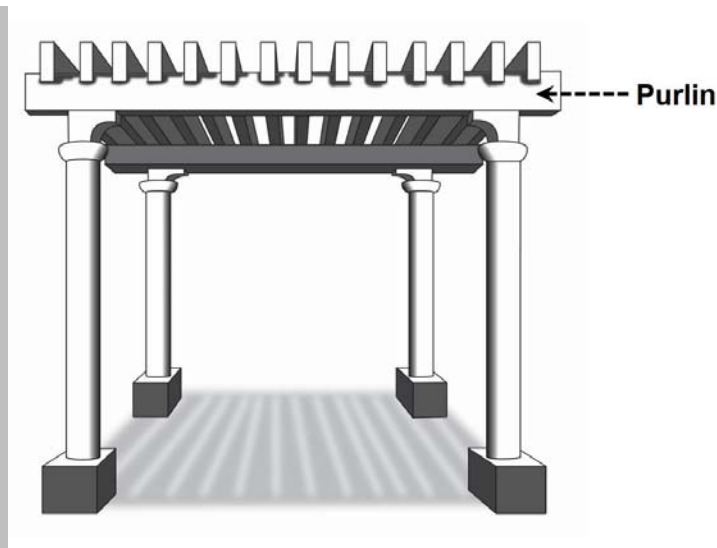

Purlin Example

Raceway is an enclosure for both wiring and electrical components.

Required landscaping Landscape Area. The specific area (on site) to be landscaped with plant material at the base of the freestanding sign.

Residential entry sign. A sign that is placed at the entrance to a multifamily and duplex development, manufactured home park, or single family development only in order to identify the name of the development.

Shingle sign. A sign suspended from a roof overhang of a covered porch or walkway which identifies the tenant of the adjoining space and perpendicular to a building wall.

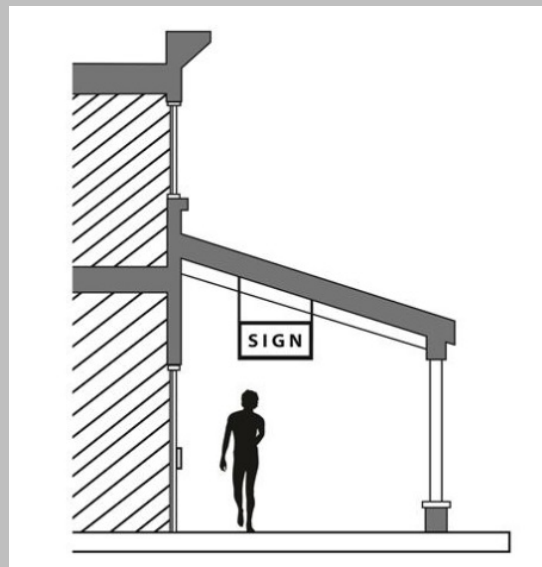

Shingle Sign Example

Sign budget. The total cumulative sign area for all types of signs allowed to a parcel or project.

Suspended Canopy Sign is a sign suspended under a canopy, roof overhang, covered walkway, covered porch, or open lattice walkway and parallel to a building wall.

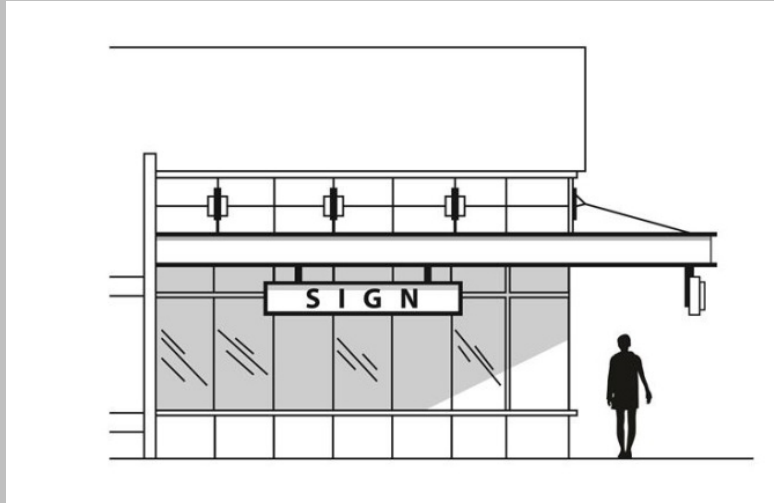

Suspended Canopy Sign Example

Sum total sign area. Aggregate area of all building signs, not including address signs twelve (12) inches or less required by Chapter 31 and 36 of the Scottsdale Revised Code, for any individual use (excluding traffic directional signs) and may include the area of a freestanding sign. In every event, computation of allowable sign area includes all existing signs on the premises, whether such signs be conforming or nonconforming unless specifically excepted by the terms of this ordinance.

~~*Traffic directional sign.* Signs used at driveways to improve public safety and to enhance public access to the site from public streets. This sign provides information which will assist the operators of vehicles in the flow of traffic. Such signs may use names, logos, or symbols of buildings, businesses, activities, uses or places as a means of direction.~~

Traffic directional sign is a freestanding sign placed near the intersection of a driveway and a street, or intersecting drive aisles, to assist the operators of vehicles to locate vehicle turning locations, and to assist in maintaining the free flow of traffic.

Section 3. Amend Sec. 8.301. – Approvals required, as follows:

Sec. 8.301. - Approvals required.

- I. A. Signs, Sign illumination, method of attachment, placement, structure, and comprehensive sign programs, master sign programs, and community sign districts created by property owners, are subject to Development Review Board approval as described in Article I.
- II. B. The Development Review Board shall review and render a decision for sign code exception requests relating signage design, and to the placement of building signs on a new multi-tenant building as provided in Sections 8.403 and 8.405. In no case shall the total sign area increase for the property.

Section 4. Amend Sec. 8.302. – Sign Programs, as follows:

Sec. 8.302. - Sign programs.

- I. *Master sign program.*
 - A. The purpose of the master sign program is to provide design compatibility for all signs and to integrate the signs with the architectural features of the multi-tenant building or complex of buildings.
 - B. Submittal requirements: The property owner(s) or designated agent shall submit an application with a specific set of design standards, including but not limited to, letter and logo sizes, letter style, colors, texture, lighting methods, sign type and architectural features.
 - C. Upon approval of the master sign program, all signage contained within the limits of the property, regardless of ownership or tenancy, shall comply with the design standards established by the program.
- II. *Community sign district.* The community sign district provides for a comprehensive sign program which is intended to encourage more flexible signage opportunities than allowed by the underlying zoning district. Community sign districts are regulated to the extent necessary to be consistent with the purpose and intent of the sign ordinance as specified in Section 8.101.
 - A. Property owners may form a community sign district to propose and maintain a comprehensive sign program for additional signage as provided in this section.
 1. A community sign district may be formed by petition of at least seventy-five (75) percent or more of the affected property owners in the community sign district.
 2. The property owner(s) in a community sign district shall coordinate the preparation and submission of the comprehensive sign program.
 3. A community sign district and its comprehensive sign program may be approved for any of the following:
 - a. **Non-residential** development(s) that have a gross floor area of at least three hundred thousand (300,000) square feet;
 - ~~b. Resorts;~~
 - ~~c. Hospitals;~~
 - ~~d.~~ **Planned districts** that have a district size of at least fifteen (15) acres;
 - ~~e.~~ **Part of a Type 1 Area** that has a linear frontage on both sides of the street totaling at least one thousand (1,000) feet; and
 - ~~f.~~ **Part of a Type 2 Area** that is comprised of contiguous lots with a gross lot area of at least five (5) acres.
 4. A community sign district allows for the following bonuses that may be approved with the comprehensive sign program:
 - a. Twenty (20) percent increase to the allowed ~~sign budget~~ **sum total sign area**;
 - b. Twenty (20) percent increase to the allowed area of signs; and
 - c. Twenty (20) percent increase to the allowed height.
 5. Only signs allowed in Article VIII may be approved as part of a ~~the~~ comprehensive sign program.

6. The comprehensive sign program shall include a complete set of standards, including but not limited to, letter size, style, colors, type(s) of sign, placement of signs, number of signs, **sign types** and sign material.
 7. The property owner(s) shall install and maintain all signage approved in the comprehensive sign program.
- B. The City Council may form a community sign district for all or part of the Downtown Area or a redevelopment district.
1. The comprehensive sign program shall include a complete set of standards, including but not limited to, letter size, style, colors, type(s) of sign, placement of signs, number of signs, and sign material. In no event may the comprehensive sign program propose signage of a type that is otherwise prohibited by this ordinance.
 2. The comprehensive sign program may include architectural signs in accordance with the following:
 - a. ~~Signs~~ **Municipal signs** may be installed **in** right-of-way that has a street classification of a minor collector or greater in the Transportation Master Plan, and on property abutting such right-of-way.
 - b. ~~Signs~~ **Municipal signs** may be installed in right-of-way or on property abutting the right-of-way at the intersection of two streets. One of the two intersecting streets shall have a classification of a minor collector or greater in the Transportation Master Plan.
 - c. The text shall be limited to the overall identification of all or part of the Downtown Area or redevelopment area.
 - d. Maximum area of sign: sixty (60) square feet.
 - e. Maximum height of sign: twenty (20) feet.
 - f. Maximum number of signs per architectural element: one (1) sign.
 - g. Maximum letter height for each architectural sign: two (2) feet.
 3. The comprehensive sign program may include banners mounted on the side of a street light pole in accordance with the following:
 - a. The banners may identify all or part of the Downtown Area or redevelopment area.
 - b. The banners shall be of new material and may be permanent, subject to Development Review Board approval of a maintenance program.
 4. The comprehensive sign program may include freestanding directory signs designed as architectural elements identifying points of interest in accordance with the following:
 - a. Maximum area of sign: fifteen (15) square feet.
 - b. Maximum height of sign: seven (7) feet.
 5. The City shall coordinate the preparation and submission of the comprehensive sign program. The application shall detail the responsibility for the installation and maintenance of signage approved in the comprehensive sign program.
- C. No sign identified in this section shall be placed upon real property without the consent of the property owner, nor shall such sign be placed in any public right-of-way, except

when placed in accordance with subsection 8.302.II.B. above and other applicable ordinances.

~~D. Any sign placed upon private property in accordance with subsection 8.302.II.B. above, shall be within an easement dedicated to the City.~~

Section 5. Repeal Sections 8.403., 8.404., 8.405., 8.406., 8.407., 8.408., 8.409., 8.410., and adopt as follows:

Sec. 8.403. - 8.410. – Reserved.

Section 6. Repeal Sections 8.412., 8.413., 8.414., 8.415., 8.416., and adopt as follows:

Sec. 8.412. - 8.416. – Reserved.

Sec. 8.418. - ~~Open and closed signs.~~ Permanent Window Signs.

- ~~1. An open or closed sign signifies that a business is open or closed.~~
- ~~2. The sign may indicate the hours of operation.~~
- ~~3.~~ 1. Maximum number of signs per business: one (1) sign.
4. 2. Maximum area of sign: two (2) square feet.
- ~~5.~~ 3. Illumination, if provided, shall be internal.
6. 4. The sign shall be placed inside the building, and may be displayed in a door or window, but no sign is permitted in unglazed openings.
- ~~7.~~ 5. The sign shall not be calculated in the sign budget for the property.
8. 6. No permit or approval shall be required for the sign, unless required by Chapters 31 and 36 of the Scottsdale Revised Code.

Section 7. Repeal Sections 8.500. through 8.538, and adopt the following:

Sec. 8.500. – Permanent Building Signs Allowed.

Sec. 8.501. – Building Sign General Provisions.

- A. All building signs shall be limited to identifying an onsite business or development.
- B. Placement.
 1. No part of a building sign shall extend above a roof line.
 2. A building sign shall be placed on a wall of the business that the sign identifies.
- C. Maximum sign area of any building sign:
 1. Forty (40) square feet in the Type 1 Area, and
 2. Two hundred fifty (250) square feet elsewhere.
- D. Maximum height of an individual character of a sign: six (6) feet.
- E. Maximum height of a cabinet or panel: six (6) feet.
- F. Individual characters of a sign shall not be mounted to the front of a raceway. When raceways are used, they shall be integrated into the cabinet, screened by a panel, or as the base for the individual letters.

Sec. 8.502. – Building Wall Signs.

A. Placement.

1. No part of the sign shall be placed a distance greater than twelve (12) inches from the building wall.

B. Building wall signs are allowed in Table 8.502.A in accordance with the following:

1. Category A, includes zoning districts shown on Table 4.100.A. Residential Districts, and the Open Space (O-S) district; or, any portion of a Planned Community P-C with an underlying zoning district comparable to the districts shown on Table 4.100.A , and the Open Space (O-S) district; or any portion of a Planned Residential Development (PRD) with an underlying zoning district comparable to the residential districts shown on Table 4.100.A.
2. Category B, includes multiple-family development's with zoning districts shown on Table 4.100.A. Residential Districts, not including Single-family Residential districts; or, any portion of a Planned Community P-C with an underlying zoning district comparable to the districts shown on Table 4.100.A , not including Single-family Residential districts; or any portion of a Planned Residential Development (PRD) with an underlying zoning district comparable to the residential districts shown on Table 4.100.A. not including Single-family Residential districts.
3. Category C, includes zoning districts shown on Table 4.100.B. Commercial Districts, 4.100.C. Industrial Districts, and 4.100.D. Mixed Use Districts, Western Theme Park (W-P), and Special Campus (S-C), not including Planned Regional Center (PRC), Service Residential (S-R), and Commercial Office (C-O); or, any portion of a Planned Community (P-C) with an underlying zoning district comparable to the districts shown on Tables 4.100.B., 4.100.C., 4.100.D, Western Theme Park (W-P), and Special Campus (S-C), not including Planned Regional Center (PRC), Service Residential (S-R), and Commercial Office (C-O).
4. Category D, includes Commercial Office (C-O), Parking P-1 District; Passenger Vehicle Parking, and Limited, and Parking P-2 District; Vehicle Parking, districts; or, any portion of a Planned Community P-C with an underlying zoning district comparable to the Commercial Office (C-O) districts, Parking P-1 District; Passenger Vehicle Parking, and Limited, and Parking P-2 District; Vehicle Parking, districts.
5. Category E, includes Planned Regional Center (PRC) districts; or, any portion of a Planned Community P-C with an underlying zoning district comparable to the Planned Regional Center (PRC) district.
6. Category F, includes Service Residential (S-R) districts; or, any portion of a Planned Community P-C with an underlying zoning district comparable to the Service Residential (S-R) district.

Table 8.502.A. Building Sign Allowances

Zoning Districts	Standards				
	Maximum sum total sign area per business ¹	Maximum sum total per development project	Maximum sign area of a business front that is less than 200 feet from any street line ²	Maximum sign area of a business front that is equal to or greater than 200 feet from any street line	Maximum Height of sign (To Top of Sign)
Category A ²	N/A	60 square feet	1 square foot for each 1 lineal foot of business front, not to exceed maximum sum total of the Development Project	1 square foot for each 1 lineal foot of business front, not to exceed maximum sum total of the Development Project	Maximum building height allowed by a lots' zoning.
Category B ²	N/A	60 square feet	1 square foot for each 1 lineal foot of business front, not to exceed maximum sum total of the Development Project	1 square foot for each 1 lineal foot of business front, not to exceed maximum sum total of the Development Project	36 feet
Category C ²	1.5 square feet of sign area for every 1 lineal foot of the longest business front	N/A	1 square foot for each 1 lineal foot of business front, not to exceed maximum sum total of the business	1.5 square feet for each 1 lineal foot of business front, not to exceed maximum sum total of the business	36 feet
Category D ²	24 square feet ⁸	N/A	1 square foot for each 1 lineal foot of business front, not to exceed maximum sum total of the business	1 square foot for each 1 lineal foot of business front, not to exceed maximum sum total of the business	36 feet
Category E ²	1.5 square feet of sign area for every 1 lineal foot of the longest business front. ³	N/A	1 square foot for each 1 lineal foot of business front, not to exceed maximum sum total of the business	1.5 square feet for each 1 lineal foot of business front, not to exceed maximum sum total of the business	36 feet ⁴
Category F ²	18 square feet ⁵	Note 6 and 7	1 square foot for each 1 lineal foot of business front, not to exceed 12 square feet	1 square foot for each 1 lineal foot of business front, not to exceed 12 square feet	18 feet

1. The maximum sum total sign area per business includes the Additional Building Sign Allowances.
2. Refer the Building Sign General Provisions for additional size restrictions.
3. The Development Review Board may approve a Sum Total Sign Area of two (2) square feet of sign area for every one (1) lineal foot of the longest business front as part of the approval of a Master Sign Program for businesses with one (1) business front facing a public street and a second business front facing the interior of a development.
4. The Development Review Board may approve a maximum sign height of 60 feet in the Planned Regional Center (PRC) district as part of the approval of a Master Sign Program
5. The Sum Total Sign Area of a development project in the Service Residential (S-R) district for wall sign includes any sign area on a free standing sign for the same business.
6. Maximum sum total sign area per development project with a gross floor area less than 40,000 square feet:72 square feet.
7. Maximum sum total per area per development project with a gross floor area great than or equal to 40,000 square feet: 144 square feet.
8. In the C-0 district, the Development Review Board may approve a Sum Total Sign Area of 1.5 square feet of sign area for every one (1) lineal foot of the longest business front as part of the approval of a Master Sign Program for a building with a gross floor area less of 50,000 square feet, or more

Sec. 8.503. – Additional Building Sign Allowances.

A. The following building sign types are allowed in the districts described in Category C and Category D, above, and the Planned Regional Center (PRC), and Service Residential (S-R), districts.

1. Suspended Canopy Sign.

- a. Maximum sign area: Same as the building wall sign area allowed for a business on Table 8.502.A.
 - i. Maximum building wall sign sum total sign area per business allowed in Table 8.502.A. shall include the sign area of a Suspended Canopy Sign.
- b. Placement: Parallel to the face of the building wall, and shall not project beyond the face of a canopy, roof overhang, covered walkway, covered porch, or open lattice walkway.
- c. Minimum Clearance: Seven (7) foot, six (6) inches from the bottom of the sign to the grade or finished surface below the sign.
- d. Maximum height of sign: Same as allowed for a building wall sign on Table 8.502.A.

2. Canopy Fascia Sign.

- a. Maximum sign area: Same as the building wall sign area allowed for a business on Table 8.502.A.
 - i. Maximum building wall sign sum total sign area per business allowed on Table 8.502.A. shall include the sign area of a Canopy Fascia Sign.
- b. Placement:
 - i. Sign shall not project above or below the fascia or purlin that the sign is attached to.
 - ii. No part of the sign shall be placed a distance greater than twelve (12) inches from the canopy fascia.
- c. Maximum height of sign: Same as allowed for a building wall sign on Table 8.502.A.

3. Shingle Sign.

- a. Maximum sign area: four (4) square feet.
 - i. Shingle signs are not included in the maximum sign area and maximum sum total sign area per business allowed on Table 8.502.A.
- b. Placement: Perpendicular to the face of the building wall, within ten (10) of the primary pedestrian entrance of the associated tenant suite, and shall not extend beyond the edge of the overhang of a covered porch or walkway.
- c. Minimum Clearance: Seven (7) foot, six (6) inches from the bottom of the sign to the grade or finished surface below the sign.

4. Freestanding Canopy Sign.

- a. Maximum number of signs: one (1) per side of canopy.
- b. Maximum sign area: one (1) square foot for each two (2) linear feet of canopy fascia, not to exceed twenty four (24) square feet on any one side of the exterior face of canopy fascia, and forty eight (48) square feet per canopy.
 - i. Maximum building wall sign sum total sign area per business allowed on Table 8.502.A. shall include the sign area of a Freestanding Canopy Sign.
- c. Placement:

- i. Sign shall be placed a minimum of six (6) inches from the top, six (6) inches from the bottom, and six (6) inches from the end (not including a circular canopy) of the freestanding canopy fascia.
 - ii. No part of the sign shall be placed a distance greater than twelve (12) inches from the building wall.
 - B. The following building sign types are allowed in the Planned Regional Center (PRC) district or any portion of a Planned Community P-C with an underlying zoning district comparable to the Planned Regional Center (PRC) district as part of an approved master sign program.
 1. Projecting Signs.
 - a. Maximum sign area: Same as the building wall sign area allowed for a business on Table 8.502.A., not to exceed thirty-six (36) square feet.
 - i. Maximum building wall sign sum total sign area per business allowed in Table 8.502.A. shall include the sign area of a Projecting Sign.
 - b. Maximum Quantity per Building: One (1) sign for each fifty (50) lineal feet of building wall.
 - c. Placement:
 - i. Unless separated by a structure and not visible from an abutting public street, such signs shall not be placed within one-hundred fifty (150) feet from an abutting public street.
 - d. Maximum Projection: Forty-eight (48) inches from the wall of the building to the outside edge of the sign.
 - e. Minimum Clearance: Eight (8) feet from the bottom of the sign to the grade or finished surface below the sign.
 - f. Minimum Separation: Twenty (20) feet between Projecting Signs on the same building wall.
 - g. Maximum height of sign: Same as allowed for a building wall sign on Table 8.502.A.
 2. Standing Canopy Signs.
 - a. Maximum sign area: Same as the building wall sign area allowed for a business on Table 8.502.A., not to exceed thirty-six (36) square feet.
 - i. Maximum building wall sign sum total sign area per business allowed in Table 8.502.A. shall include the sign area of a Standing Canopy Sign.
 - b. Placement:
 - i. Parallel to the adjacent building façade.
 - ii. The front face of the sign shall not project beyond the leading edge of the canopy or lattice.
 - c. Design Standards:
 - i. The sign shall limited to individual characters.
 - ii. Raceways shall be concealed with in the canopy or lattice.
 - iii. The Development Review Board may approve individual character up to a maximum of forty (40) inches.
 - d. Maximum height of sign: As allowed in the PRC district on Table 8.502.A.
 - C. The following building sign type is allowed the zoning district of Category B, Category C, and Category D described above, and Planned Regional Center (PRC), Service Residential (S-

R), or any portion of a Planned Community P-C or Planned Residential Development (PRD) with an underlying zoning district comparable to Planned Regional Center (PRC), Service Residential (S-R) districts.

1. Awning Signs.

- a. Maximum sign area: twenty (20) percent of the total front face area of the awning, or the business front, whichever is less.
 - i. Maximum building wall sign sum total sign area per business allowed in Table 8.502.A. shall include the sign area of an Awning Sign.
- b. Placement: sign may be placed on the awning valance, body or wing.
- c. Illumination: The copy of an awning sign may only be illuminated by a light source internal to the awning.

D. The following building sign types are allowed in all zoning districts:

1. Entry Signs

- a. Maximum sign area: One (1) square foot
- b. Placement: Within ten (10) feet of the primary entrance of a tenant suite or dwelling unit.
- c. Maximum height: Ten (10) feet from the top of the sign to the grade or finished surface below the sign.
- d. Maximum projection from a building wall: four (4) inches.

2. Address Signs

- a. Maximum height of letters: Twelve (12) inches.
 - 1. An address that has a height greater twelve (12) inches is a building wall sign.
- b. Maximum height and width of a backer panel: three (3) inches greater than copy height and width.
- c. Signs placed within a height of eight (8) feet measured from grade or finished surface, may project a maximum of four (4) inches from the building wall.
- d. Signs placed above eight (8) feet measured from grade or finished surface may project a maximum of twelve (12) inches from the building wall.

Sec. 8.504 – 8.509. Reserved.

Sec. 8.510. – Permanent Freestanding Signs Allowed

Sec. 8.511. – Freestanding Sign General Provisions.

- A. All onsite freestanding signs shall be limited to identifying an onsite business or development project.
- B. The following shall apply to all freestanding signs.
 - 1. Placement:
 - a. A freestanding sign shall be placed in a manner so not to interfere with traffic in any way, or to confuse traffic, or to present any traffic hazard.
 - b. Signs shall not obstruct the sight distance requirements of the Design Standards and Policies Manual.
 - c. All permanent freestanding signs shall be set back a minimum of fifteen (15) feet from back of curb, unless a lesser setback is approved.

C. Landscape Requirements.

1. Minimum landscape area requirements for column, tower, mid-size monument, monument, and landscape wall signs:
 - a. Signs equal to or less than twelve (12) feet in height: two hundred forty (240) square feet.
 - b. Signs greater than twelve (12) feet in height: twenty (20) square feet multiplied by the total height of the sign.

D. Minimum distance between the top of the freestanding sign structure and the sign copy: six (6) inches.

E. The maximum number of onsite businesses or development projects identified on a freestanding sign shall be in accordance with Table 8.511.E.

Table 8.511.E. Maximum Number of Businesses or Development Project Identification	
Freestanding Sign type	Maximum number of onsite businesses or development project identified
Column	1
Directory Sign	Not applicable
Drive-Through	Not applicable
Entryway Monument Sign	1
Entryway Wall Sign	1
Gas Station Monument	2
Landscape Wall	1
Mid-size Monument	4
Monument	2
Tower	4
Traffic Directional	Not applicable

F. Freestanding signs in the Type 1 Area of the Downtown:

1. Column, Drive-Through, Entryway Monument Sign, Entryway Wall Sign, Landscape Wall, Mid-size Monument, Monument, Perimeter Site Wall, and Tower signs are prohibited in the Type 1 Area of the Downtown.

G. Scenic Corridor.

1. The provisions of Section 8.411. shall apply.

Sec. 8.512 –Freestanding Subdivision Signs.

A. Freestanding signs allowed:

1. Recorded land divisions in all zoning districts are allowed freestanding signs in accordance with Table 8.512.A.
 - a. A recorded condominium land division development project may utilize the freestanding sign allowances of the development project's property zoning in-lieu of freestanding subdivision sign allowances of this section.

2. Maximum number of freestanding sign types allowed:
 - a. A land division with zero (0) to less than ten (10) gross acres: one (1) sign type per street.
 - b. A land division with greater than or equal to ten (10) gross acres, and less than one hundred (100) acres: two (2) sign types, or two (2) of the same sign type, per street.
 - c. A land division with greater than or equal to one hundred (100) acres: four (4) sign types, a combination of four (4) sign types, or four (4) of the same sign type, per street.

Example 8.512.A. Recorded Land Division Freestanding Sign Quantity

A land division with one hundred fifty (150) acres is allowed four (4) sign types per street. The property owner may choose: 1) one of each of the allowed sign types; 2) four (4) of the same sign type; 3) two (2) of one sign type and two (2) of another sign type; or 4) one (1) sign type and three (3) of another sign type.

Table 8.512.A. Land Division Freestanding Sign Allowances

Sign Types											
Monument Sign			Entryway Wall Sign			Entryway Monument Sign			Landscape Wall Sign		
Maximum Quantity of Signs	Height	Sum Total Area of Sign per Face	Maximum Quantity of Signs	Height	Sum Total Area of Sign per Face	Maximum Quantity of Signs	Height	Sum Total Area of Sign per Face	Maximum Quantity of Signs	Height	Sum Total Area of Sign per Face
1	5 feet	24 sqft	Note 1	5 feet	24 sqft	1	5 feet	24 sqft	1	Note 2	Note 3

Notes:

1. Maximum quantity of entryway wall signs: One (1) sign on each side of an entry driveway or street into the land division.
2. The maximum height of a Landscape Wall Sign is 5 feet. The Development Review Board may approve a Landscape Wall Sign up to a height equal to seventy-five (75) percent of the total height of the wall that the sign will be placed, not exceed eight (8) feet. No sign shall be placed higher than two (2) feet above the average wall height within 25 feet of either side of the sign.
3. The maximum area of a sign:
 - a. Zero to less than forty (40) gross acres: 24 square feet
 - b. Greater than or equal to forty (40) gross acres, and less than one hundred (100) acres: 48 square feet
 - c. Greater than or equal to one hundred (100) acres: 72 square feet

3. Placement of Entryway Wall and Entryway Monument Signs:
 - a. Entryway wall signs shall be placed on one, or both sides, of the entry driveway or street into the development project, and within twenty-five (25) feet from the back of

- the curb of the driveway or street, or edge of the pavement when a curb is not provided.
- b. Entryway monument signs shall be placed in a landscape median that is between the inbound and outbound vehicular traffic lanes of the entry driveway or private street; or, the sign may be placed adjacent to the inbound or outbound vehicular traffic lane.

Sec. 8.513. – Freestanding signs for non-residential developments (excluding the R-5 district) and multiple-family developments in residential districts, and O-S.

A. Freestanding signs are allowed:

1. Non-residential development projects with a zoning districts shown on Table 4.100.A. Residential Districts, and Open Space (O-S) district, excluding the Multiple Family Residential (R-5); or, any portion of a Planned Community (P-C), or Planned Residential Development (PRD), with an underlying zoning district comparable to the districts shown on Table 4.100.A. and the Open Space (O-S) district, excluding the Multiple Family Residential (R-5), are allowed the freestanding signs are on Table 8.513.A.
 - a. Maximum number of freestanding sign types per street: one (1) sign type.
2. Multiple family development projects within a zoning districts shown Table 4.100.A. Residential Districts; or, any portion of a Planned Community (P-C), or Planned Residential Development (PRD), with an underlying zoning district comparable to the districts shown on Table 4.100.A., are allowed the freestanding signs on Table 8.513.A.
 - a. Maximum number of freestanding sign types per street: one (1) sign type.

Table 8.513.A. Freestanding signs for non-residential developments (excluding the R-5 district) and multiple-family developments in residential districts, and O-S district.

Street Classification	Development project width at the property line abutting the street that the freestanding sign is to be place adjacent to.	Freestanding Sign Types					
		Monument Sign			Landscape Wall Sign		
		Quantity of Signs Per Street	Height	Sum Total Area of Sign per Face	Quantity of Signs Per Street	Height	Sum Total Area of Sign per Face
All Classifications	Any width abutting a street	1	5 feet	24 sqft	1	5 feet	24 sqft

Sec. 8.514. – Freestanding signs for non-residential developments in the R-5 district

A. Freestanding signs are allowed:

1. Non-residential development in the Multiple Family Residential (R-5) districts; or, any portion of a Planned Community (P-C) with an underlying zoning district comparable to the Multiple Family Residential (R-5) district, are allowed the freestanding signs on Table 8.514.A.
 - a. Maximum number of freestanding sign types per street: one (1) sign type.

Table 8.514.B. Freestanding Sign Allowances for a Non-residential Uses in a R-5 District

Gross Floor Area of all Building in a Development Project	Street Classification	Development project width at the street line abutting the street that the freestanding sign is to be placed adjacent to.	Freestanding Sign Types											
			Tower Sign			Mid-Size Monument Sign			Monument Sign			Landscape Wall Sign		
			Quantity of Signs Per Street	Height	Sum Total Area of Sign per Face	Quantity of Signs Per Street	Height	Sum Total Area of Sign per Face	Quantity of Signs Per Street	Height	Sum Total Area of Sign per Face	Quantity of Signs Per Street	Height	Sum Total Area of Sign per Face
Equal to, or greater than, 30,000 square feet	Arterial	Equal to, or greater than, 300 feet	1	15 feet	50 sqft	1	8 feet	50 sqft	1	5 feet	24 sqft	1	5 feet	24 sqft
Equal to, or greater than, 30,000 square feet	Arterial	Less than 300 feet	0	N/A	N/A	1	8 feet	50 sqft	1	5 feet	24 sqft	1	5 feet	24 sqft
Less than 30,000 square feet	All Streets	All widths	0	N/A	N/A	0	N/A	N/A	1	5 feet	24 sqft	1	5 feet	24 sqft

N/A = Not Allowed

Sec. 8.515. – All Developments in Commercial, Industrial, Mixed Use, P-1, P-2, S-C, and W-P districts.

- A. Freestanding signs are allowed in the zoning districts of Category E, and in accordance with the development project's gross floor area indicated in B.
 - 1. Category E, includes: zoning districts shown Table 4.100.B. Commercial Districts, 4.100.C. Industrial Districts, and 4.100.D. Mixed Use Districts, Parking P-1 District, Passenger Vehicle Parking, and Limited, Parking P-2 District, Special Campus (S-C) and Western Theme Park (W-P); and, any portion of a Planned Community (P-C) with an underlying zoning district comparable to the districts shown on 4.100.B., 4.100.C., and 4.100.D., Parking P-1 District, Passenger Vehicle Parking, and Limited, Parking P-2 District, Special Campus (S-C) and Western Theme Park (W-P) shall comply with:
- B. Development projects with a gross floor area:
 - 1. Less than 30,000 square feet are allowed freestanding signs in accordance with Table 8.515.B.1.
 - a. Maximum number of free standing sign types per street: one (1) sign type.
 - 2. Equal to or greater than 30,000 square feet, and less than 60,000 square feet, are allowed freestanding signs in accordance with Table 8.515.B.2.
 - a. Maximum number of free standing sign types per street: one (1) sign type.
 - 3. Equal to or greater than 60,000 square feet, and less than 100,000 square feet, are allowed freestanding signs in accordance with Table 8.515.B.3.
 - a. Maximum number of free standing sign types per street: one (1) sign type.
 - 4. Equal to or greater than 100,000 square feet allowed freestanding signs in accordance with Table 8.514.B.4.
 - a. Maximum number of free standing sign types per street: one (1) sign type.

Table 8.515.B.1. Freestanding Sign Allowances for a Development Project with a Gross Floor Area Less than 30,000 Square Feet							
Street Classification	Development project width at the street line abutting the street that the freestanding sign is to be placed adjacent to.	Freestanding Sign Types					
		Monument Sign			Landscape Wall Sign		
		Quantity of Signs Per Street	Height	Sum Total Area of Sign per Face	Quantity of Signs Per Street	Height	Sum Total Area of Sign per Face
All Classifications	Any width abutting a street	1	5 feet	24 sqft	1	5 feet	24 sqft

Table 8.515.B.2. Freestanding Sign Allowances for a Development Project with a Gross Floor Area Equal to or Greater than 30,000 Square Feet and Less than 60,000 Square Feet													
Street Classification	Development project width at the street line abutting the street that the freestanding sign is to be placed adjacent to.	Freestanding Sign Types											
		Tower Sign			Mid-Size Monument Sign			Monument Sign			Landscape Wall Sign		
		Quantity of Signs Per Street	Height	Sum Total Area of Sign per Face	Quantity of Signs Per Street	Height	Sum Total Area of Sign per Face	Quantity of Signs Per Street	Height	Sum Total Area of Sign per Face	Quantity of Signs Per Street	Height	Sum Total Area of Sign per Face
Arterial or Collector	Equal to, or greater than, 300 feet	1	15 feet	50 sqft	2	8 feet	30 sqft	1	5 feet	24 sqft	1	5 feet	24 sqft
Arterial or Collector	Less than 300 feet	0	N/A	N/A	1	8 feet	30 sqft	1	5 feet	24 sqft	1	5 feet	24 sqft
Unclassified	Equal to, or greater than, 300 feet	0	N/A	N/A	1	8 feet	30 sqft	1	5 feet	24 sqft	1	5 feet	24 sqft
Unclassified	Less than 300 feet	0	N/A	N/A	1	6 feet	24 sqft	1	5 feet	24 sqft	1	5 feet	24 sqft
Unclassified	Any width abutting a residential district on Table 4.100.A.	0	N/A	N/A	0	N/A	N/A	1	5 feet	24 sqft	1	5 feet	24 sqft

N/A = Not allowed

Table 8.515.B.3. Freestanding Sign Allowances for a Development Project with a Gross Floor Area Equal to or Greater than 60,000 Square Feet and Less than 100,000 Square Feet													
Street Classification	Development project width at the street line abutting the street that the freestanding sign is to be place adjacent to.	Freestanding Sign Types											
		Tower Sign			Mid-Size Monument Sign			Monument Sign			Landscape Wall Sign		
		Quantity of signs Per Street	Height	Sum Total Area of Sign per Face	Quantity of signs Per Street	Height	Sum Total Area of Sign per Face	Quantity of signs Per Street	Height	Sum Total Area of Sign per Face	Quantity of signs Per Street	Height	Sum Total Area of Sign per Face
Arterial or Collector	Equal to, or greater than, 300 feet	1	20 feet	75 sqft	2	10 feet	40 sqft	1	5 feet	24 sqft	1	5 feet	24 sqft
Arterial or Collector	Less than 300 feet	0	N/A	N/A	1	10 feet	40 sqft	1	5 feet	24 sqft	1	5 feet	24 sqft
Unclassified	Equal to, or greater than, 300 feet	0	N/A	N/A	1	8 feet	30 sqft	1	5 feet	24 sqft	1	5 feet	24 sqft
Unclassified	Less than 300 feet	0	N/A	N/A	1	6 feet	24 sqft	1	5 feet	24 sqft	1	5 feet	24 sqft
Unclassified	Any width abutting a residential district on Table 4.100.A.	0	N/A	N/A	0	N/A	N/A	1	5 feet	24 sqft	1	5 feet	24 sqft
N/A = Not Allowed													

Table 8.515.B.4. Freestanding Sign Allowances for a Development Project with a Gross Floor Area Equal to, or Greater than, 100,000 Square Feet													
Street Classification	Development project width at the street line abutting the street that the freestanding sign is to be place adjacent to.	Freestanding Sign Types											
		Tower Sign			Mid-Size Monument Sign			Monument Sign			Landscape Monument Sign		
		Quantity of signs Per Street	Height	Sum Total Area of Sign per Face	Quantity of signs Per Street	Height	Sum Total Area of Sign per Face	Quantity of signs Per Street	Height	Sum Total Area of Sign per Face	Quantity of signs Per Street	Height	Sum Total Area of Sign per Face
Arterial or Collector	Equal to, or greater than, 300 feet	1	25 feet	120 sqft	2	12 feet	60 sqft	1	5 feet	24 sqft	1	5 feet	24 sqft
Arterial or Collector	Less than 300 feet	0	N/A	N/A	1	12 feet	60 sqft	1	5 feet	24 sqft	1	5 feet	24 sqft
Unclassified	Equal to, or greater than, 300 feet	0	N/A	N/A	1	10 feet	40 sqft	1	5 feet	24 sqft	1	5 feet	24 sqft
Unclassified	Less than 300 feet	0	N/A	N/A	1	6 feet	32 sqft	1	5 feet	24 sqft	1	5 feet	24 sqft
Unclassified	Any width abutting a residential district on Table 4.100.A.	0	N/A	N/A	0	N/A	N/A	1	5 feet	24 sqft	1	5 feet	24 sqft
N/A = Not Allowed													

Sec. 8.516. – Additional freestanding sign allowances.

A. Entryway Signs.

1. Entryway signs are allowed in:
 - a. Multiple family developments with a zoning district shown on Table 4.100.A. Residential Districts; or, any portion of a Planned Community (P-C) with an underlying zoning district comparable to the districts shown on Table 4.100.A.
 - b. Non-residential developments with Resort/Townhouse Residential (R-4R) zoning and Multiple-family Residential (R-5) zoning; or, any portion of a Planned Community (P-C) or Planned Residential Development (PRD) zoning, with an underlying zoning district comparable to the Resort/Townhouse Residential (R-4R) and Multiple-family Residential (R-5) districts.
3. Maximum Quantity:
 - a. One (1) entryway wall sign on each side of an entry driveway; or
 - b. One (1) entryway monument sign
4. Placement:
 - a. Entryway wall signs shall be placed on one, or both sides, of the entry driveway or street into the development project, and within twenty-five (25) feet from the back of the curb of the driveway or street, or edge of the pavement when a curb is not provided.
 - b. Entryway monument signs shall be placed in a landscape median that is between the inbound and outbound vehicular traffic lanes of the entry driveway or private street; or, the sign may be placed adjacent to the inbound or outbound vehicular traffic lane.
5. Maximum Height: Five (5) feet.
 - a. Exception. The Development Review Board may approve an entryway wall sign up to a height equal to seventy-five (75) percent of the total height of the wall that the sign will be placed, not exceed eight (8) feet. No sign shall be placed higher than two (2) feet above the average wall height within 25 feet of either side of the sign.
6. Maximum Area: Twenty-four (24) square feet
7. Maximum sum total sign area: Forty-eight (48) square feet.

B. Gas Station Monument Signs

1. Gas Station development projects or development sites are allowed a Gas Station Monument Sign in-lieu of the development's freestanding sign allowed in a Section 8.515.
2. Maximum Quantity: one (1) sign per street.
3. Maximum Height: Five (5) square feet.
4. Maximum Area: Thirty (30) square feet.
5. Maximum Fuel Change Panel Area: one-half of the area of the sign may be Fuel Change Panels to display fuel prices in accordance with Arizona Administrative Code.

C. Drive-Through Signs.

1. Drive-thru signs are allowed in zoning district shown on Table 4.100.B. Commercial Districts, 4.100.C. Industrial Districts, and 4.100.D. Mixed Use Districts, not including the Downtown or Downtown Overlay districts, or any portion of a Planned Community P-C with an underlying

zoning district comparable to the districts shown on 4.100.B., 4.100.C., and 4.100.D., not including the Downtown or Downtown Overlay district.

2. Maximum Quantity: Two (2) sign per drive-through lane.
3. Placement:
 - a. Within ten (10) feet of the drive-through lane; and
 - b. At least twenty (20) feet from any street line
4. Maximum Height: Seven (7) square feet
5. Maximum Area: Forty-five (45) square feet
6. Drive-thru sign shall be screened from streets, subject to Development Review Board approval.

D. Directory Signs.

1. Multiple family and non-residential development projects with zoning district shown on Tables 4.100.A. Residential Districts; 4.100.B. Commercial Districts, 4.100.C. Industrial Districts, and 4.100.D. Mixed Use Districts, Open Space (O-S), Western Theme Park (W-P), and Special Campus (S-C) zoning; or, any portion of a Planned Community P-C with an underlying zoning district comparable to the districts shown on Tables 4.100.A., 4.100.B., 4.100.C., and 4.100.D. and Open Space (O-S), Western Theme Park (W-P), and Special Campus (S-C) zoning, are allowed directory signs.
2. Quantity of signs: subject to Development Review Board approval.
3. Maximum Height:
 - a. Seven (7) feet, not including the Planned Regional Center (PRC) district; and
 - b. Twelve (12) feet in the Planned Regional Center (PRC) district.
4. Placement:
 - a. Signs equal to, or less than seven (7) feet: Unless separated by a structure and not visible from an abutting street, freestanding directory signs shall not be placed within 100 feet from a street line.
 - b. Signs greater than seven (7) feet: Unless separated by a structure and not visible from an abutting street, freestanding directory signs shall not be placed within 150 feet from a street line.
5. Maximum Area: Four (4) square feet per panel.
6. Maximum Sum Total Area: Thirty-two (32) square feet.

E. Traffic Directional Signs.

1. Multiple family and non-residential development projects with zoning district shown on Tables 4.100.A. Residential Districts; 4.100.B. Commercial Districts, 4.100.C. Industrial Districts, and 4.100.D. Mixed Use Districts, Open Space (O-S), Western Theme Park (W-P), and Special Campus (S-C) zoning; or, any portion of a Planned Community P-C with an underlying zoning district comparable to the districts shown on Tables 4.100.A., 4.100.B., 4.100.C., and 4.100.D. and Open Space (O-S), Western Theme Park (W-P), and Special Campus (S-C) zoning, are allowed traffic directional signs.
2. Maximum number of signs for each driveway: one (1) sign.

3. Maximum number of signs for each drive aisle internal to a development project: subject to Development Review Board approval.
3. Maximum height of sign: three (3) feet.
4. Placement:
 - a. Adjacent to a street and driveway intersection: Within fifty (50) feet from the back of the curb of the driveway, or the edge of the pavement when a curb is not provided; and
 - b. Within a development project: Locations shall be approved by the Development Review Board.
5. Maximum area of sign:
 - a. Driveway and drive aisle accessing one (1) lot: four (4) square feet.
 - b. Driveway and drive aisle accessing two (2) or more lots: eight (8) square feet.

F. Column Signs.

1. Freestanding Column Signs are allowed in development projects that:
 - a. Are zoned Planned Regional Center (PRC); or any portion of a Planned Community P-C with an underlying zoning district comparable to Planned Regional Center (PRC) zoning; and
 - b. Have a gross floor area equal to, or greater than, 100,000 square feet.
3. Quantity of signs: One (1) freestanding column sign may be utilized in-lieu of one of the freestanding sign types allowed in Table 8.514.A.4.
3. Maximum Height: twenty-five (25) square feet
4. Maximum diameter or width: six (6) feet
5. Placement:
 - a. Signs shall be placed adjacent to an arterial or collector street with a development project street line width equal to, or greater than, 300 feet.
6. Maximum Area: one hundred fifty (150) square feet

G. Perimeter site wall signs

1. Perimeter site wall signs are allowed in zoning districts shown on Table 4.100.B. Commercial Districts, 4.100.C. Industrial Districts, and 4.100.D. Mixed Use Districts, Western Theme Park (W-P), and Special Campus (S-C) zoning; or any portion of a Planned Community P-C with an underlying zoning district comparable to the districts shown on Tables 4.100.B., 4.100.C., and 4.100.D. and Western Theme Park (W-P), and Special Campus (S-C) zoning.
2. The Development Review Board may approve a master sign program that includes relocating a portion of the allowed sum total sign area for a business to be located on a development project's perimeter site wall, upon finding that the sign placement improves visibility, limits the proliferation and clutter of signage adjacent to a street, maintains the surrounding character, and achieves a higher quality of sign placement and design.
3. Maximum Quantity per onsite business: one (1) sign
4. Maximum Area: ten (10) square feet.
5. Sum total area of all perimeter site wall signs: (1) square foot for each one thousand (1,000) square feet of gross floor area of a development project.

Sec. 8.517 – Freestanding Signs in Planned Community (P-C) and Planned Residential Development (PRD) Districts.

A. Onsite freestanding signs are allowed in the Planned Community (P-C) and Planned Residential Development (PRD) districts.

1. Minimum Area of the Planned Community (P-C) or Planned Residential Development (PRD) district: one hundred sixty (160) acres.
2. Maximum Quantity of signs in a Planned Community (P-C) or Planned Residential Development (PRD) district: One (1) sign per street entrance into the district.
3. Maximum sign area: One hundred (100) square feet
4. Maximum Height: Eight (8) feet.
5. Placement:
 - a. Maximum number of signs placed adjacent to a street entrance: Two (2) signs.
 - b. Within five hundred (500) feet of the Planned Community (P-C) or Planned Residential Development (PRD) district boundary, and within 100 feet of the right-of-way or private street tract that enters into the Planned Community (P-C) or Planned Residential Development (PRD) district.