

Exterior Building Color & Material Samples

Color Drawdowns

Archaeological Resources

Airport Vicinity Development Checklist

Parking Study

Trip Generation Comparison

Parking Master Plan



STIPULATION SET
RETAIN FOR RECORDS
APPROVED

COLOR SUBMITTAL

40-DR-2016
8/12/16

THE #1 CHOICE OF
PAINTING PROFESSIONALS

Job Name: **Rancho Paraiso**
 Painting Contractor: **0**
 General Contractor: **0**
 Architect/Designer: **Douglas Fredrikson**

DATE: **8/29/2017**
 INITIALS: *[Signature]*

Date: **August 11, 2016**
 Product: **SSHL10**
 Color: **DE6060 Twilight Taupe**
 Area / Sheen: **Flat**
 D.E. Contact: **Tim Garver 602.714.7280**

This submittal is intended for color and sheen approval and may not have been produced from the actual product specified. Dunn-Edwards recommends following the procedures outlined in PDCA Std. P5-09 Sample Procedures.

Dunn Edwards

151 07:46 8/2/2016 PHX PANEL LAB

DE 6384

IRON FIXTURE

SSHL10-0 SPRTASHLD EX FLAT

Rev. Date 03/26/2010

1 Quart U.Y Notation /48

04: 0 Y+ 10.000

08: 0 Y+ 10.000

13: 1 Y+ 2.000

14: 1 Y+ 23.000

Custom Tinted Paint - Not Returnable for Exchange or Refund

Color may vary slightly from a color chip or container to container.
Check for correct color match and confirm color before application.
Dunn-Edwards accepts no responsibility for any mis-matched paint
after it has been applied.



STIPULATION SET
RETAIN FOR RECORDS

COLOR SUBMITTAL

40-DR-2016
8/12/16

THE #1 CHOICE OF
PAINTING PROFESSIONALS®

Job Name

Rancho Palisades

Painting Contractor

0

General Contractor

0

Architect/Designer

Douglas Fredrikson

Date:

August 11, 2016

Product:

SSHL10

Color:

DE6379 Silver Lake

Area / Sheen:

Flat

D.E. Contact:

Tim Garver

602.714.7280

This submittal is intended for color and sheen approval and may not have been produced from the actual product specified. Dunn-Edwards recommends following the procedures outlined in PDCA Std. P5-09 Sample Procedures.

APPROVED
DATE 8/29/17
INITIALS

Dunn Edwards

151 07:44 8/2/2016 PHX PANEL LAB

DE 6379

SILVER LAKE

SSHL10-0 SPRTASHLD EX FLAT

Rev Date 03/26/2010

1 Quart L Y-Notation /48

04: 0 Y+ 0.250

08: 0 Y+ 0.250

13: 0 Y+ 1.250

Custom Tinted Paint - Not Returnable for Exchange or Refund
Color may vary slightly from a color chip or container to container.
Check for correct color match and confirm color before application.
Dunn-Edwards accepts no responsibility for any mis-matched paint
after it has been applied.



STIPULATION SET
RETAIN FOR RECORDS
APPROVED

COLOR SUBMITTAL

40-DR-2016
8/12/16

THE #1 CHOICE OF
PAINTING PROFESSIONALS!

Job Name:

Rancho Paraiso

Painting Contractor:

0

General Contractor:

0

Architect/Designer:

Douglas Fredrikson

Date:

August 11, 2016

Product:

SSHL10

Color:

DE6384 Iron Fixture

Area / Sheen:

Flat

D.E. Contact:

Tim Garver

602.714.7280

This submittal is intended for color and sheen approval and may not have been produced from the actual product specified. Dunn-Edwards recommends following the procedures outlined in PDCA Std. P5-09 Sample Procedure

Dunn Edwards

151 07:46 8/2/2016 PHX PANEL LAB

DE 6384

IRON FIXTURE

SSHL10-0 SPRTASHLD EX FLAT

Rev Date 03/26/2010

1 Quart U Y Notation /48

04: 0 Y+ 10.000

08: 0 Y+ 10.000

13: 1 Y+ 2.000

14: 1 Y+ 23.000

Custom Tinted Paint - Not Returnable for Exchange or Refund

Color may vary slightly from a color chip or container to container.
Check for correct color match and confirm color before application.
Dunn-Edwards accepts no responsibility for any mis-matched paint
after it has been applied.

AVinylFence.com
LOWEST PRICES SINCE 1996



A Vinyl Fence and Deck Company, Inc. - 1080 Broadway Ave - San Jose, CA 95125 - 1-800-431-4720



40-DR-2016
8/12/16

6'-0" HIGH VINYL FENCE - PRODUCT DATA

(<http://www.avinylfence.com/>)



(<http://www.bbb.org/sanjose/business-reviews/fence-contractors/a-vinyl-fence-in-san-jose-ca-212302#bbbseal>)

Search

Sign In (<https://www.avinylfence.com/LOGN.php>) Get My Quote ([https://www.avinylfence.com/mm5/merchant.mvc?](https://www.avinylfence.com/mm5/merchant.mvc?SessionID=6896572&ProductID=34489177))

Subtotal: \$0.00 [View My Cart](http://www.avinylfence.com/BASK.php)

Home (<http://www.avinylfence.com/>) Fencing **▼** (<http://www.avinylfence.com/category/vinyl-fencing.php>)

1 (800) 431-4720

Gates **▼** (<http://www.avinylfence.com/category/gates.php>) Prices **▼** (<http://www.avinylfence.com/category/prices.php>)

General Information **▼** (<http://www.avinylfence.com/category/general-info.php>)

Home (<http://www.avinylfence.com/>) > Fencing (<http://www.avinylfence.com/category/vinyl-fencing.php>) >

Certagrain - 4 Rail Horse Fence - White

The Truth About Vinyl Fence Wall Thickness:
Wall thickness of vinyl fence is **NOT** a true measure of strength or performance. It is touted by those who would mislead in order to make a sale. [More](http://www.avinylfence.com/vinyl-fence-wall-thickness.php) (<http://www.avinylfence.com/vinyl-fence-wall-thickness.php>)

**We Are Now Open Call Us Toll Free at 1-800-431-4720
No Phone Trees! Talk To Us Direct Now.**

[Click here to have us give you a call. \(.callMe.php\)](#)



Click on the Image Above to Enlarge

Price per linear foot as selected: **\$11.36**

Fence Height:

5 Feet **▼**

Fence Color:

Colonial White

Choose Number of Linear Feet or Sections:

Vinyl fencing is sold by the linear foot. The number of feet entered will be rounded up automatically to the nearest number of sections.

Section Width: 16 Feet

Enter Number of Feet:

Or Number of Sections:

You will receive (0 feet of fencing)

Please Note: Each section includes one post and one post cap. Complete Section includes everything you need including the galvanized steel insert for bottom rail. There are no screws, brackets, or wood inside the posts like the discount stores.

* Our price per foot includes posts, caps, rails and all the pickets, picket caps and stainless steel fasteners (galvanized steel inserts on selected styles). When comparing prices with our competitors, be sure that ALL componenets are included.

Scroll Down the page for Dimensions, Gates and More Details

Specifications:

Style: Post & Rail

Fence Colors: Colonial White

Fence Height: 5'

Rails: 1-1/2" x 5-1/2" Ribbed

Installation: [Post & Rail Installation Instructions](#)

(<http://www.avinylfence.com/documents/bufftech-post-and-rail-installation.pdf>)

You May Also Be Interested In These Related Items

Regarding Additional Posts: All fences include one post per section.

[View My Cart](http://www.avinylfence.com/BASK.php)

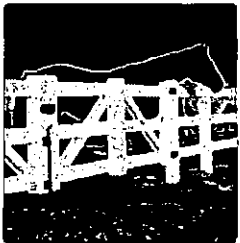

(<http://www.avinylfence.com/product/horse-fence-certagrain-white-4-rail-gate.php>)

Certagrain White 4 Rail - Gate

(<http://www.avinylfence.com/product/horse-fence-certagrain-white-4-rail-gate.php>)

Prices Starting From: \$598.35

Product Details

(<http://www.avinylfence.com/product/horse-fence-certagrain-white-4-rail-gate.php>)



(<http://www.avinylfence.com/product/post-certagrain-4-rail.php>)

Posts - Certagrain 4 Rail

(<http://www.avinylfence.com/product/post-certagrain-4-rail.php>)

Prices Starting From: \$30.58

Product Details

(<http://www.avinylfence.com/product/post-certagrain-4-rail.php>)

Specifications

Gates

Installation

Warranty

Shipping

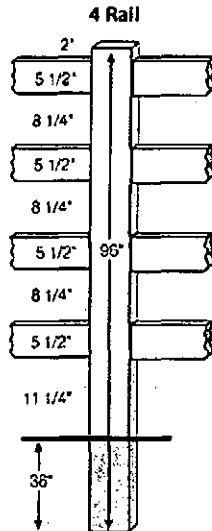

The lock ring secures the rail inside of the post.

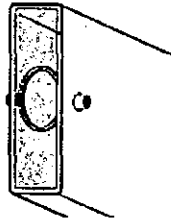

Available in Ribbed or Hollow rail.

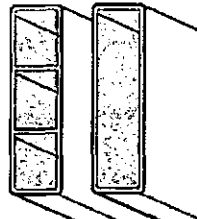

NOTE: Our rails are 16 ft. (191 1/2 ") long and the posts are set at 8 ft. on center which means each 16 ft. section has two posts and caps included in price. When installing the rails, we suggest that for the first section only, a 16 ft. rail be cut in two and used as the middle rail on a 3 rail fence or 2nd and 4th rail on 4 rail. Thereafter use all 16 ft rails This serves to make the installation stronger since the rails all terminate on alternating posts.

We currently don't have pictures of gates for this fence style. However, below is a picture from our 3 Rail horse fence gates to give you a better idea of what the gates look like.

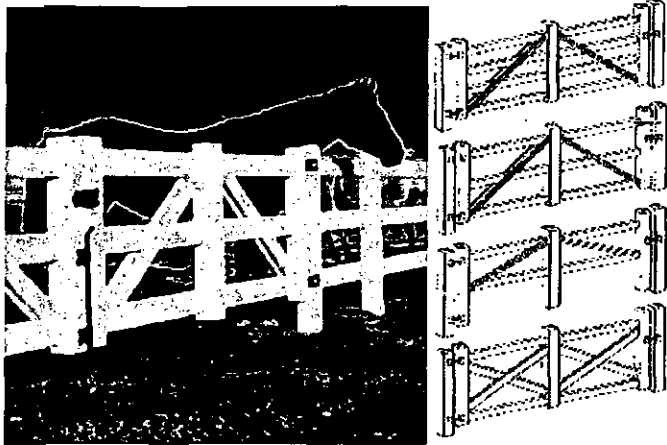

Installation Manuals & Tools You'll Need

[Bufftech Vinyl Fence Installation Instructions - Complete](http://www.avinylfence.com/documents/BT_Install_Complete.pdf) (http://www.avinylfence.com/documents/BT_Install_Complete.pdf) [pdf] 2mb

[Variable Terrain Installation Instructions](http://www.avinylfence.com/documents/bufftech-variable-terrain-fence-installation.pdf) (<http://www.avinylfence.com/documents/bufftech-variable-terrain-fence-installation.pdf>) [pdf] 142kb

[Tools You'll Need](http://www.avinylfence.com/documents/bufftech-tools-youll-need.pdf) (<http://www.avinylfence.com/documents/bufftech-tools-youll-need.pdf>) [pdf] 168kb

Getting Started

- Site plans
- Measuring tape
- Hammer
- Wooden Stakes
- String line
- Spray paint for hole centers for post and gate spacing
- Wooden Spacer bar for post and gate spacing

Assembling Fence / Gates

- Hacksaw, circular saw or chop saw with masonry blade
- Square
- #3 square drive bit
- Phillips #2 screwdriver
- Drill and drill bits
 - 1/8" for #8 screws
 - 1/4" for bullet clips and drain holes
 - 5/32" for gate hardware if using aluminum insert
 - 3/8" for lock rings
- 1/2" deep socket (or nut driver) for traditional picket

Digging Holes

- Post hole digging tools
 - Shovel
 - Post hole digger
 - 10" auger for 4x4 posts
 - 12" auger for 5x5 posts

Installing Post

- Wheelbarrow
- Concrete mixing tools
- Short length of wood, 2x4 for tamping concrete
- Garden hose
- Level
- Template kit with router
- Spiral saw

Installing Bottom Rail

- Leveling blocks
- Shim stock
- Duct tape to seal rail ends

Installing Gate(s)

- Wrench
 - 7/16" for hinge nuts
- Flat screwdriver to activate hinge spring

Filing Post with Concrete

- Rubber mallet to tamp post

- Funnel for filling post
- Ladder for high fences

Lifetime Warranty

Download Entire Warranty (<http://www.avinylfence.com/documents/bufftech-limited-lifetime-warranty.pdf>) [pdf] 656 kb

What and Who Is Covered and for How Long

CertainTeed warrants to the original homeowner/consumer that its Bufftech vinyl fence products will be free from manufacturing defects - including peeling, flaking, blistering and corroding - when subject to normal and proper use.

Should any such defect occur during the lifetime of the original purchaser (and as long as the original purchaser is still living and retains ownership of the property), CertainTeed will repair or replace, at its option, the defective fence product. Except during the SureStart™ protection period, described below, CertainTeed also reserves the right to refund the amount paid by the original owner for the fence.

CertainTeed shall not be liable or responsible for labor charges or other expenses whatsoever in connection with removal or installation of either the original or replacement product.

In the event of repair or replacement under the terms of this warranty, the original warranty shall apply to the repaired or replacement fence material, and will extend for the balance of the warranty period in effect at the time the material proved defective.

The lifetime coverage offered by this warranty automatically ends upon the sale of the property or death of the last of the original owners of the property at the time of installation.

The lifetime coverage offered by this warranty is designed to cover individual homeowners only. In the case of fence material purchased by, or installed upon property owned by, corporations, governmental agencies, partnerships, trusts, religious organizations, schools, condominiums or cooperative housing arrangements, or installed on apartment building or any other type of building or premises not used by individual homeowners as their residences, the warranty period will be 30 years following the installation of the fence.

SureStart™ Protection

CertainTeed vinyl fence products are covered by SureStart protection for a period of five years following the date when installation has been completed. Under this warranty feature, CertainTeed, at no charge, will repair or replace, at its option, any fence proven to be defective during the five-year SureStart period. CertainTeed's maximum liability under SureStart will be equal to the reasonable cost to replace the defective fence at its current value, including labor.

Shipping

Shipping will come directly to you from the factory. Please Call For Shipping Lead Times. We ship worldwide and can deliver to any freight forwarder in the Continental U.S. If you don't have a freight forward company, we can help you get one.

Since we get factory direct rates, our freight costs are very reasonable. Most companies will call you before arriving to arrange a day and time for delivery. Please be sure to have a representative on site at the time of delivery.

For a shipping quote, please call 1-800-431-4720

Large shipments may be delivered on pallets and you will need to help unload the truck. A forklift is generally used to offload large shipments, but the pallets can be broken open to be offloaded by hand. Most residential deliveries will need to be offloaded by hand.

The driver is only responsible to get the order to the end of the truck. It will be your responsibility to remove it. This only applies to common carrier deliveries, not to UPS and FedEx type of deliveries.

In Case Of Damaged or Missing Goods

The factory loads the truck with the correct items and then it is the trucking company's responsibility to get it to you in good condition.

Any shortage or damage must be noted on the bill of lading at the time of delivery. If damage is found after the driver has left, the trucking company must be notified and a claim filed. Please make all claims promptly.

Frequently, an inspector will be sent out to see the damage or to note a shortage. It is your responsibility to seek reimbursement from the trucking company for any damages or shortages. We will help you in any way we can. The trucking company will provide the appropriate forms for filing a claim.

Replacement Orders

Replacement orders should be placed promptly with A Vinyl Fence and Deck Company, Inc so installation of your fence can proceed as scheduled. Please call us at 1-800-431-4720 before returning any items. You may incur a 25% restocking fee plus the cost of shipping both ways if a return order is NOT authorized.

If material is returned for credit, it will be your responsibility to package the material securely and safely. If the material is damaged, it will not be accepted by the manufacturer and no credit will be issued.

About Us (<http://www.avinylfence.com/ABUS.php>) | Contact Us

(<https://www.avinylfence.com/mm5/merchant.mvc?>

Session_ID=b8596512a9dd38e503a4d691f770353e&Screen=CTUS)



(<https://smarticon.geotrust.com/smarticonprofile?Referer=http://www.avinylfence.com>)



BBB
Rating: A+

Click for
Review

(<http://www.bbb.org/sanjose/business-reviews/fence-contractors/a-vinyl-fence-in-san-jose-ca-212302#bbbseal>)

| Shipping & Handling

(<http://www.avinylfence.com/SARP.php>)

| Returns

(<http://www.avinylfence.com/returns.php>)

| FAQs (<http://www.avinylfence.com/FAQS.php>)

| Privacy Policy

(<http://www.avinylfence.com/PRPO.php>)

Copyright © 2016 A Vinyl Fence and Deck Company, Inc. · 1080 Broadway Ave · San Jose, CA 95125 · 1-800-431-4720

(<http://www.avinylfence.com/>)



(<http://www.bbb.org/sanjose/business-reviews/fence-contractors/a-vinyl-fence-in-san-jose-ca-212302#bbbseal>)

Sign In (<https://www.avinylfence.com/LOGN.php>) Get My Quote ([https://www.avinylfence.com/mm5/merchantLmvc?](https://www.avinylfence.com/mm5/merchantLmvc?Session_ID=885965123990386503446691770351&Screen=QIN))

Subtotal: \$0.00 (<http://www.avinylfence.com/BASK.php>)

Home (<http://www.avinylfence.com/>) Fencing ▾ (<http://www.avinylfence.com/category/vinyl-fencing.php>)

1 (800) 431-4720

Gates ▾ (<http://www.avinylfence.com/category/gates.php>) Prices ▾ (<http://www.avinylfence.com/category/prices.php>)

General Information ▾ (<http://www.avinylfence.com/category/general-info.php>)

Home (<http://www.avinylfence.com/>) > Fencing (<http://www.avinylfence.com/category/vinyl-fencing.php>) >

Pasture Rail - 4 Rail Horse Fence

**We Are Now Open Call Us Toll Free at 1-800-431-4720
No Phone Trees! Talk To Us Direct Now.
[Click here to have us give you a call. \(/callMe.php\)](#)**



Click on the image above to enlarge

Price per linear foot as selected: **\$7.99**

Fence Height:

▾

Fence Color:

Choose Number of Linear Feet or Sections:

Vinyl fencing is sold by the linear foot. The number of feet entered will be rounded up automatically to the nearest number of sections.

Section Width: 16 Feet

Enter Number of Feet:

Or Number of Sections:

You will receive (0 feet of fencing)

Please Note: Each section includes one post and one post cap. Complete Section includes everything you need including the galvanized steel insert for bottom rail. There are no screws, brackets, or wood inside the posts like the discount stores.

Minimum order: 500 ft.

Looks great and provides a safe environment for the little guys. 4-Rail is recommended for other livestock such as cattle or sheep. 54" - 60" high.

*Our price per foot includes posts, caps, rails and all the pickets, picket caps and stainless steel fasteners (galvanized steel inserts on selected styles). When comparing prices with our competitors, be sure that ALL components are included.

Scroll Down the page for Dimensions, Gates and More Details

Specifications:

Style: Post & Rail

Fence Colors: White

Fence Height: 4 1/2'

Rails: 1-1/2" x 5-1/2" x 192"

Installation: [Post & Rail Installation Instructions](#)

(<http://www.avinylfence.com/documents/bufftech-post-and-rail-installation.pdf>)

You May Also Be Interested In These Related Items

Regarding Additional Posts: All fences include one post per section.

[View My Cart](http://www.avinylfence.com/BASK.php) (<http://www.avinylfence.com/BASK.php>)



(<http://www.avinylfence.com/product/horse-fence-standard-4-rail-gate.php>)

Standard Rail - 4 Rail - Gate
(<http://www.avinylfence.com/product/horse-fence-standard-4-rail-gate.php>)

Prices Starting From: \$564.41

Product Details

(<http://www.avinylfence.com/product/horse-fence-standard-4-rail-gate.php>)



(<http://www.avinylfence.com/product/post-standard-4-rail.php>)

Posts - Standard 4 Rail
(<http://www.avinylfence.com/product/post-standard-4-rail.php>)

Prices Starting From: \$26.86

Product Details

(<http://www.avinylfence.com/product/post-standard-4-rail.php>)

Specifications

Gates

Installation

Warranty

Shipping

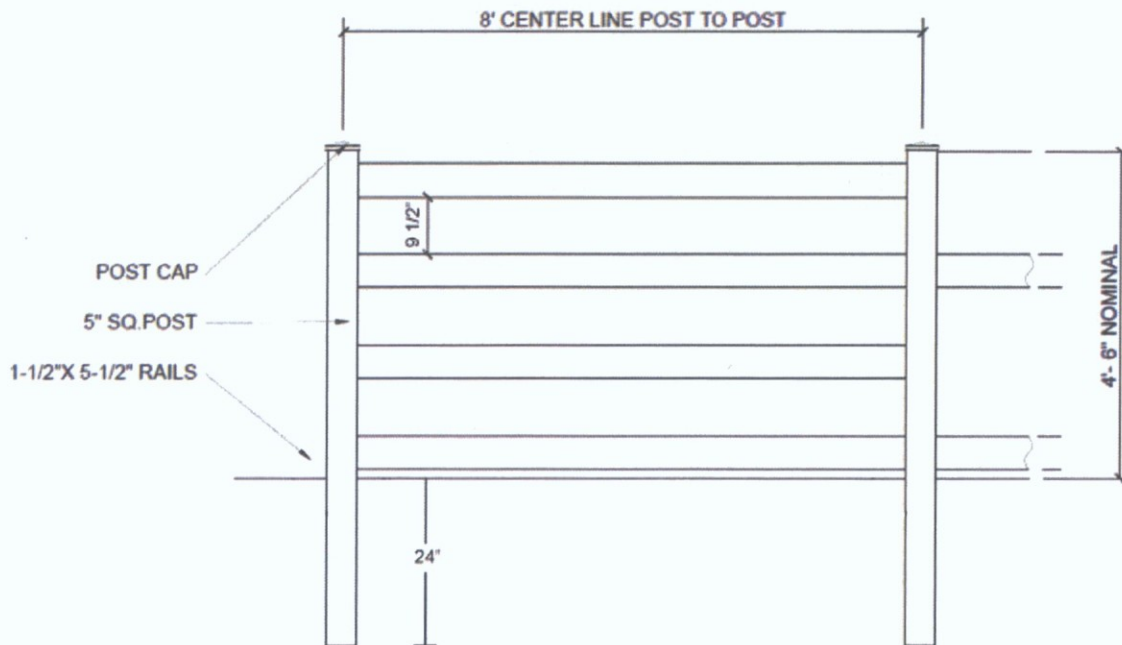

Note: It is recommended that at beginning of each run, cut one 16 ft. rail in two and start the 8 ft. rail in the first and 3rd position from the top. Thereafter, run all 16 ft. rails. This alternates the termination point of the rails and makes for a stronger installation over all.

We currently don't have pictures of gates for this fence style. For gate information and pricing, please call 1-800-431-4720.

Installation Manuals & Tools You'll Need

[Bufftech Vinyl Fence Installation Instructions - Complete](http://www.avinylfence.com/documents/BT_Install_Complete.pdf) (http://www.avinylfence.com/documents/BT_Install_Complete.pdf) [pdf] 2mb

[Variable Terrain Installation Instructions](http://www.avinylfence.com/documents/bufftech-variable-terrain-fence-installation.pdf) (<http://www.avinylfence.com/documents/bufftech-variable-terrain-fence-installation.pdf>) [pdf] 142kb

[Tools You'll Need](http://www.avinylfence.com/documents/bufftech-tools-youll-need.pdf) (<http://www.avinylfence.com/documents/bufftech-tools-youll-need.pdf>) [pdf] 168kb

Getting Started

- Site plans
- Measuring tape
- Hammer
- Wooden Stakes
- String line
- Spray paint for hole centers for post and gate spacing
- Wooden Spacer bar for post and gate spacing

Assembling Fence / Gates

- Hacksaw, circular saw or chop saw with masonry blade
- Square
- #3 square drive bit
- Phillips #2 screwdriver
- Drill and drill bits
 - 1/8" for #8 screws
 - 1/4" for bullet clips and drain holes
 - 5/32" for gate hardware if using aluminum insert
 - 3/8" for lock rings
- 1/2" deep socket (or nut driver) for traditional picket

Digging Holes

- Post hole digging tools
 - Shovel
 - Post hole digger
 - 10" auger for 4x4 posts
 - 12" auger for 5x5 posts

Installing Post

- Wheelbarrow
- Concrete mixing tools
- Short length of wood, 2x4 for tamping concrete
- Garden hose
- Level
- Template kit with router
- Spiral saw

Installing Bottom Rail

- Leveling blocks
- Shim stock
- Duct tape to seal rail ends

Installing Gate(s)

- Wrench
 - 7/16" for hinge nuts
- Flat screwdriver to activate hinge spring

Filling Post with Concrete

- Rubber mallet to tamp post
- Funnel for filling post
- Ladder for high fences

Lifetime Warranty

[Download Entire Warranty \(http://www.avinylfence.com/documents/bufftech-limited-lifetime-warranty.pdf\)](http://www.avinylfence.com/documents/bufftech-limited-lifetime-warranty.pdf) [pdf] 656 kb

What and Who is Covered and for How Long

CertainTeed warrants to the original homeowner/consumer that its Bufftech vinyl fence products will be free from manufacturing defects - including peeling, flaking, blistering and corroding - when subject to normal and proper use.

Should any such defect occur during the lifetime of the original purchaser (and as long as the original purchaser is still living and retains ownership of the property), CertainTeed will repair or replace, at its option, the defective fence product. Except during the SureStart™ protection period, described below, CertainTeed also reserves the right to refund the amount paid by the original owner for the fence.

CertainTeed shall not be liable or responsible for labor charges or other expenses whatsoever in connection with removal or installation of either the original or replacement product.

In the event of repair or replacement under the terms of this warranty, the original warranty shall apply to the repaired or replacement fence material, and will extend for the balance of the warranty period in effect at the time the material proved defective.

The lifetime coverage offered by this warranty automatically ends upon the sale of the property or death of the last of the original owners of the property at the time of installation.

The lifetime coverage offered by this warranty is designed to cover individual homeowners only. In the case of fence material purchased by, or installed upon property owned by, corporations, governmental agencies, partnerships, trusts, religious organizations, schools, condominiums or cooperative housing arrangements, or installed on apartment building or any other type of building or premises not used by individual homeowners as their residences, the warranty period will be 30 years following the installation of the fence.

SureStart™ Protection

CertainTeed vinyl fence products are covered by SureStart protection for a period of five years following the date when installation has been completed. Under this warranty feature, CertainTeed, at no charge, will repair or replace, at its option, any fence proven to be defective during the five-year SureStart period. CertainTeed's maximum liability under SureStart will be equal to the reasonable cost to replace the defective fence at its current value, including labor.

Shipping

Shipping will come directly to you from the factory. Please Call For Shipping Lead Times. We ship worldwide and can deliver to any freight forwarder in the Continental U.S. If you don't have a freight forward company, we can help you get one.

Since we get factory direct rates, our freight costs are very reasonable. Most companies will call you before arriving to arrange a day and time for delivery. Please be sure to have a representative on site at the time of delivery.

For a shipping quote, please call 1-800-431-4720

Large shipments may be delivered on pallets and you will need to help unload the truck. A forklift is generally used to offload large shipments, but the pallets can be broken open to be offloaded by hand. Most residential deliveries will need to be offloaded by hand.

The driver is only responsible to get the order to the end of the truck. It will be your responsibility to remove it. This only applies to common carrier deliveries, not to UPS and FedEx type of deliveries.

In Case Of Damaged or Missing Goods

The factory loads the truck with the correct items and then it is the trucking company's responsibility to get it to you in good condition.

Any shortage or damage must be noted on the bill of lading at the time of delivery. If damage is found after the driver has left, the trucking company must be notified and a claim filed. Please make all claims promptly.

Frequently, an inspector will be sent out to see the damage or to note a shortage. It is your responsibility to seek reimbursement from the trucking company for any damages or shortages. We will help you in any way we can. The trucking company will provide the appropriate forms for filing a claim.

Replacement Orders

Replacement orders should be placed promptly with A Vinyl Fence and Deck Company, Inc so installation of your fence can proceed as scheduled. Please call us at 1-800-431-4720 before returning any items. You may incur a 25% restocking fee plus the cost of shipping both ways if a return order is NOT authorized.

If material is returned for credit, it will be your responsibility to package the material securely and safely. If the material is damaged, it will not be accepted by the manufacturer and no credit will be issued.

About Us (<http://www.avinylfence.com/ABUS.php>) | Contact Us

(<https://www.avinylfence.com/mm5/merchant.mvc?>

Session_ID=b8596512a9dd38e503a4d691f770353e&Screen=CTUS)



(<https://smarticon.geotrust.com/smarticonprofile?Referer=http://www.avinylfence.com>)



BBB
Rating: A+

Click for
Review

(<http://www.bbb.org/sanjose/business-reviews/fence-contractors/a-vinyl-fence-in-san-jose-ca-212302#bbbseal>)

| [Shipping & Handling](#)

(<http://www.avinylfence.com/SARP.php>)

| [Returns](#)

(<http://www.avinylfence.com/returns.php>)

| [FAQs](#) (<http://www.avinylfence.com/FAQS.php>)

| [Privacy Policy](#)

(<http://www.avinylfence.com/PRPO.php>)

Copyright © 2016 A Vinyl Fence and Deck Company, Inc. · 1080 Broadway Ave · San Jose, CA 95125 · 1-800-431-4720

(<http://www.avinylfence.com/>)



(<http://www.bbb.org/sanjose/business-reviews/fence-contractors/a-vinyl-fence-in-san-jose-ca-212302#bbbseal>)

Search

Sign In (<https://www.avinylfence.com/LOGN.php>) Get My Quote (https://www.avinylfence.com/mm5/merchant.mvc?Session_ID=b8596512&order_id=034406917703536&Screen=QINF)

Subtotal: \$0.00 View My Cart (<http://www.avinylfence.com/BASK.php>)

Home (<http://www.avinylfence.com/>) Fencing ▾ (<http://www.avinylfence.com/category/vinyl-fencing.php>)

1 (800) 431-4720

Gates ▾ (<http://www.avinylfence.com/category/gates.php>) Prices ▾ (<http://www.avinylfence.com/category/prices.php>)

General Information ▾ (<http://www.avinylfence.com/category/general-info.php>)

Home (<http://www.avinylfence.com/>) > Fencing (<http://www.avinylfence.com/category/vinyl-fencing.php>) >

Standard Rail - 4 Rail Horse Fence

We Are Now Open Call Us Toll Free at 1-800-431-4720
No Phone Trees! Talk To Us Direct Now.
[Click here to have us give you a call. \(/callMe.php\)](#)



Click on the Image Above to Enlarge

Price per linear foot as selected: **\$10.33**

Fence Height:

5 Feet ▾

Fence Color:

White Almond

Choose Number of Linear Feet or Sections:

Vinyl fencing is sold by the linear foot. The number of feet entered will be rounded up automatically to the nearest number of sections.

Section Width: 16 Feet

Enter Number of Feet:

Or Number of Sections:

Calculate

You will receive (0 feet of fencing)

Please Note: Each section includes one post and one post cap. Complete Section includes everything you need including the galvanized steel insert for bottom rail. There are no screws, brackets, or wood inside the posts like the discount stores.

Next

Looks great and provides a safe environment for the little guys. 4-Rail is recommended for other livestock such as cattle or sheep. 54" - 60" high.

*Our price per foot includes posts, caps, rails and all the pickets, picket caps and stainless steel fasteners (galvanized steel inserts on selected styles). When comparing prices with our competitors, be sure that ALL components are included.

Scroll Down the page for Dimensions, Gates and More Details

Specifications:

Style: Post & Rail

Fence Colors: White, Almond

Fence Height: 5'

Rails: 1-1/2" x 5-1/2" Ribbed

Installation: [Post & Rail Installation Instructions](#)

(<http://www.avinylfence.com/documents/bufftech-post-and-rail-installation.pdf>)

You May Also Be Interested In These Related Items

Regarding Additional Posts: All fences include one post per section.

[View My Cart \(http://www.avinylfence.com/BASK.php\)](http://www.avinylfence.com/BASK.php)



(<http://www.avinylfence.com/product/horse-fence-standard-4-rail-gate.php>)

Standard Rail - 4 Rail - Gate
(<http://www.avinylfence.com/product/horse-fence-standard-4-rail-gate.php>)

Prices Starting From: \$564.41

Product Details
(<http://www.avinylfence.com/product/horse-fence-standard-4-rail-gate.php>)



(<http://www.avinylfence.com/product/post-standard-4-rail.php>)

Posts - Standard 4 Rail
(<http://www.avinylfence.com/product/post-standard-4-rail.php>)

Prices Starting From: \$26.86

Product Details
(<http://www.avinylfence.com/product/post-standard-4-rail.php>)

Specifications

Gates

Installation

Warranty

Shipping

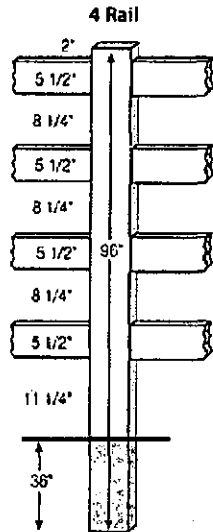

The lock ring secures the rail inside of the post.

Available in Ribbed or Hollow rail.

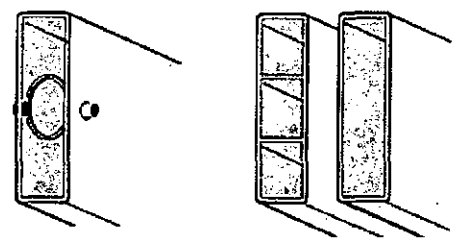

NOTE: Our rails are 16 ft. (191 1/2 ") long and the posts are set at 8 ft. on center which means each 16 ft. section has two posts and caps included in price. When installing the rails, we suggest that for the first section only, a 16 ft. rail be cut in two and used as the middle rail on a 3 rail fence or 2nd and 4th rail on 4 rail. Thereafter use all 16 ft rails This serves to make the installation stronger since the rails all terminate on alternating posts.

We currently don't have pictures of gates for this fence style. However, below is a picture from our 3 Rail horse fence gates to give you a better idea of what the gates look like.

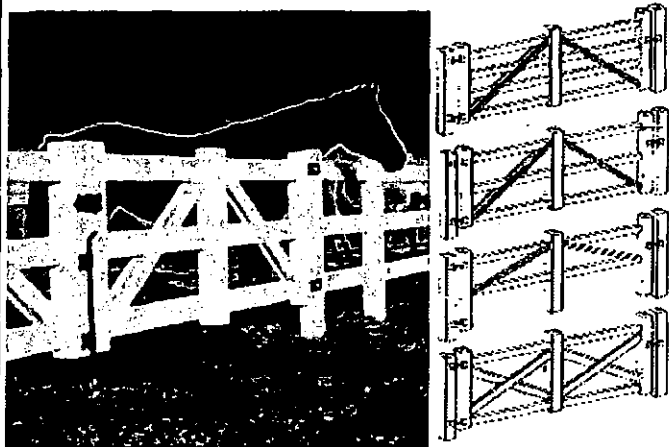

Installation Manuals & Tools You'll Need

[Bufftech Vinyl Fence Installation Instructions - Complete](http://www.avinylfence.com/documents/BT_Install_Complete.pdf) (http://www.avinylfence.com/documents/BT_Install_Complete.pdf) [pdf] 2mb

[Variable Terrain Installation Instructions](http://www.avinylfence.com/documents/bufftech-variable-terrain-fence-installation.pdf) (<http://www.avinylfence.com/documents/bufftech-variable-terrain-fence-installation.pdf>) [pdf] 142kb

[Tools You'll Need](http://www.avinylfence.com/documents/bufftech-tools-youll-need.pdf) (<http://www.avinylfence.com/documents/bufftech-tools-youll-need.pdf>) [pdf] 168kb

Getting Started

- Site plans
- Measuring tape
- Hammer
- Wooden Stakes
- String line
- Spray paint for hole centers for post and gate spacing
- Wooden Spacer bar for post and gate spacing

Assembling Fence / Gates

- Hacksaw, circular saw or chop saw with masonry blade
- Square
- #3 square drive bit
- Phillips #2 screwdriver
- Drill and drill bits
 - 1/8" for #8 screws
 - 1/4" for bullet clips and drain holes
 - 5/32" for gate hardware if using aluminum insert
 - 3/8" for lock rings
- 1/2" deep socket (or nut driver) for traditional picket

Digging Holes

- Post hole digging tools
 - Shovel
 - Post hole digger
 - 10" auger for 4x4 posts
 - 12" auger for 5x5 posts

Installing Post

- Wheelbarrow
- Concrete mixing tools
- Short length of wood, 2x4 for tamping concrete
- Garden hose
- Level
- Template kit with router
- Spiral saw

Installing Bottom Rail

- Leveling blocks
- Shim stock
- Duct tape to seal rail ends

Installing Gate(s)

- Wrench
 - 7/16" for hinge nuts
- Flat screwdriver to activate hinge spring

Filing Post with Concrete

- Rubber mallet to tamp post

- Funnel for filling post
- Ladder for high fences

Lifetime Warranty

Download Entire Warranty (<http://www.avinylfence.com/documents/bufftech-limited-lifetime-warranty.pdf>) [pdf] 656 kb

What and Who Is Covered and for How Long

CertainTeed warrants to the original homeowner/consumer that its Bufftech vinyl fence products will be free from manufacturing defects - including peeling, flaking, blistering and corroding - when subject to normal and proper use.

Should any such defect occur during the lifetime of the original purchaser (and as long as the original purchaser is still living and retains ownership of the property), CertainTeed will repair or replace, at its option, the defective fence product. Except during the SureStart™ protection period, described below, CertainTeed also reserves the right to refund the amount paid by the original owner for the fence.

CertainTeed shall not be liable or responsible for labor charges or other expenses whatsoever in connection with removal or installation of either the original or replacement product.

In the event of repair or replacement under the terms of this warranty, the original warranty shall apply to the repaired or replacement fence material, and will extend for the balance of the warranty period in effect at the time the material proved defective.

The lifetime coverage offered by this warranty automatically ends upon the sale of the property or death of the last of the original owners of the property at the time of installation.

The lifetime coverage offered by this warranty is designed to cover individual homeowners only. In the case of fence material purchased by, or installed upon property owned by, corporations, governmental agencies, partnerships, trusts, religious organizations, schools, condominiums or cooperative housing arrangements, or installed on apartment building or any other type of building or premises not used by individual homeowners as their residences, the warranty period will be 30 years following the installation of the fence.

SureStart™ Protection

CertainTeed vinyl fence products are covered by SureStart protection for a period of five years following the date when installation has been completed. Under this warranty feature, CertainTeed, at no charge, will repair or replace, at its option, any fence proven to be defective during the five-year SureStart period. CertainTeed's maximum liability under SureStart will be equal to the reasonable cost to replace the defective fence at its current value, including labor.

Shipping

Shipping will come directly to you from the factory. Please Call For Shipping Lead Times. We ship worldwide and can deliver to any freight forwarder in the Continental U.S. If you don't have a freight forward company, we can help you get one.

Since we get factory direct rates, our freight costs are very reasonable. Most companies will call you before arriving to arrange a day and time for delivery. Please be sure to have a representative on site at the time of delivery.

For a shipping quote, please call 1-800-431-4720

Large shipments may be delivered on pallets and you will need to help unload the truck. A forklift is generally used to offload large shipments, but the pallets can be broken open to be offloaded by hand. Most residential deliveries will need to be offloaded by hand.

The driver is only responsible to get the order to the end of the truck. It will be your responsibility to remove it. This only applies to common carrier deliveries, not to UPS and FedEx type of deliveries.

In Case Of Damaged or Missing Goods

The factory loads the truck with the correct items and then it is the trucking company's responsibility to get it to you in good condition.

Any shortage or damage must be noted on the bill of lading at the time of delivery. If damage is found after the driver has left, the trucking company must be notified and a claim filed. Please make all claims promptly.

Frequently, an inspector will be sent out to see the damage or to note a shortage. It is your responsibility to seek reimbursement from the trucking company for any damages or shortages. We will help you in any way we can. The trucking company will provide the appropriate forms for filing a claim.

Replacement Orders

Replacement orders should be placed promptly with A Vinyl Fence and Deck Company, Inc so installation of your fence can proceed as scheduled. Please call us at 1-800-431-4720 before returning any items. You may incur a 25% restocking fee plus the cost of shipping both ways if a return order is NOT authorized.

If material is returned for credit, it will be your responsibility to package the material securely and safely. If the material is damaged, it will not be accepted by the manufacturer and no credit will be issued.

About Us (<http://www.avinylfence.com/ABUS.php>) | Contact Us

(<https://www.avinylfence.com/mm5/merchant.mvc?>

Session ID=b8596512a9dd38e503a4d691f770353e&Screen=CTUS)



(<https://smarticon.geotrust.com/smarticonprofile?Referer=http://www.avinylfence.com/>)



BBB
Rating: A+

Click for
Review

(<http://www.bbb.org/sanjose/business-reviews/fence-contractors/a-vinyl-fence-in-san-jose-ca-212302#bbbseal>)

| Shipping & Handling

(<http://www.avinylfence.com/SARP.php>)

| Returns

(<http://www.avinylfence.com/returns.php>)

| FAQs (<http://www.avinylfence.com/FAQS.php>)

| Privacy Policy

(<http://www.avinylfence.com/PRPO.php>)

(<http://www.avinylfence.com/>)



(<http://www.bbb.org/sanjose/business-reviews/fence-contractors/a-vinyl-fence-in-san-jose-ca-212302#bbbseal>)

Search

Sign In (<https://www.avinylfence.com/LOGN.php>) Get My Quote (https://www.avinylfence.com/mmm5/merchant.mvc?Session_ID=08596512a9dd38e503a4d6911770353e&Screen=QIN)

Subtotal: \$0.00 View My Cart (<http://www.avinylfence.com/BASK.php>)

Home (<http://www.avinylfence.com/>) Fencing ▾ (<http://www.avinylfence.com/category/vinyl-fencing.php>)

1 (800) 431-4720

Gates ▾ (<http://www.avinylfence.com/category/gates.php>) Prices ▾ (<http://www.avinylfence.com/category/prices.php>)

General Information ▾ (<http://www.avinylfence.com/category/general-info.php>)

Home (<http://www.avinylfence.com/>) > Fencing (<http://www.avinylfence.com/category/vinyl-fencing.php>) >

Big Rail - 4 Rail Horse Fence

The Truth About Vinyl Fence Wall Thickness:
Wall thickness of vinyl fence is **NOT** a true measure of strength or performance. It is touted by those who would mislead in order to make a sale. [More](http://www.avinylfence.com/vinyl-fence-wall-thickness.php) (<http://www.avinylfence.com/vinyl-fence-wall-thickness.php>)

**We Are Now Open Call Us Toll Free at 1-800-431-4720
No Phone Trees! Talk To Us Direct Now.**

[Click here to have us give you a call. \(/callMe.php\)](#)



Click on the Image Above to Enlarge

Price per linear foot as selected: **\$12.80**

Fence Height:

5 Feet ▾

Choose Number of Linear Feet or Sections:

Vinyl fencing is sold by the linear foot. The number of feet entered will be rounded up automatically to the nearest number of sections.

Section Width: 16 Feet

Enter Number of Feet:

Or Number of Sections:

Calculate

You will receive (0 feet of fencing)

Please Note: Each section includes one post and one post cap. Complete Section includes everything you need including the galvanized steel insert for bottom rail. There are no screws, brackets, or wood inside the posts like the discount stores.

Scroll Down the page for Dimensions, Gates and More Details

Specifications:

Style: Post & Rail

Fence Colors: White, Almond

Fence Height: 5'

Rails: 2" x 6" Hollow or 2" x 6" Ribbed

Installation: [Post & Rail Installation Instructions](#)

(<http://www.avinylfence.com/documents/bufftech-post-and-rail-installation.pdf>)

Fence Color:

White Almond

Next

At 54" - 60" high, this is one of our sturdiest ranch and farm fences available. Great for keeping outsiders out and the babies in.

* Our price per foot includes posts, caps, rails and all the pickets, picket caps and stainless steel fasteners (galvanized steel inserts on selected styles). When comparing prices with our competitors, be sure that ALL components are included.

You May Also Be Interested In These Related Items

Regarding Additional Posts: All fences include one post per section.

[View My Cart \(http://www.avinylfence.com/BASK.php\)](http://www.avinylfence.com/BASK.php)

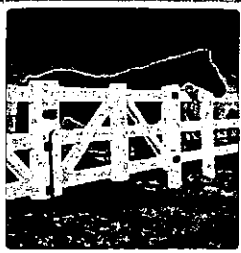

(<http://www.avinylfence.com/product/fence-big-4-rail-gate.php>) (<http://www.avinylfence.com/product/post-big-4-rail.php>)

Big Rail - 4 Rail - Gate

(<http://www.avinylfence.com/product/fence-big-4-rail-gate.php>) (<http://www.avinylfence.com/product/post-big-4-rail.php>)

Prices Starting From: \$585.36

[Product Details](#)

Posts - Big 4 Rail

(<http://www.avinylfence.com/product/post-big-4-rail.php>)

Prices Starting From: \$26.86

[Product Details](#)

(<http://www.avinylfence.com/product/fence-big-4-rail-gate.php>) (<http://www.avinylfence.com/product/post-big-4-rail.php>)

Specifications

Gates

Installation

Warranty

Shipping

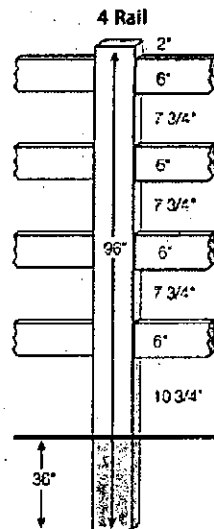

The lock ring secures the rail inside of the post.

Available in Ribbed or Hollow rail.

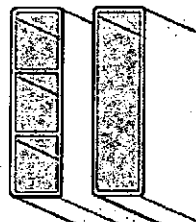
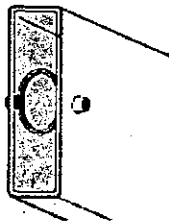

NOTE: Our rails are 16 ft. (191 1/2 ") long and the posts are set at 8 ft. on center which means each 16 ft. section has two posts and caps *included in price*. When installing the rails, we suggest that for the first section only, a 16 ft. rail be cut in two and used as the middle rail on a 3 rail fence or 2nd and 4th rail on 4 rail. Thereafter use all 16 ft. rails This serves to make the installation stronger since the rails all terminate on alternating posts.

We currently don't have pictures of gates for this fence style. However, below is a picture from our 3 Rail horse fence gates to give you a better idea of what the gates look like.

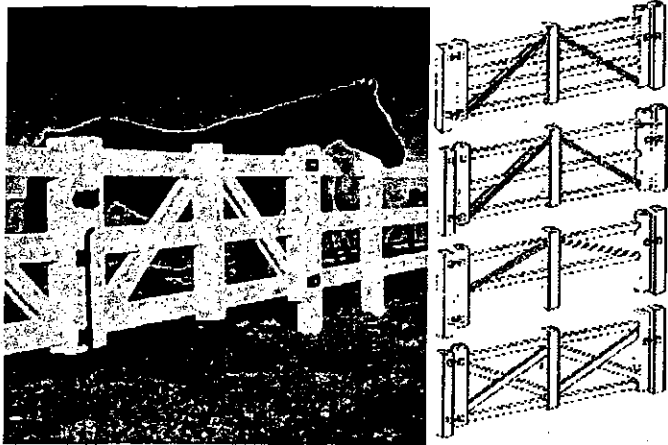

Installation Manuals & Tools You'll Need

[Bufftech Vinyl Fence Installation Instructions - Complete](http://www.avinylfence.com/documents/BT_Install_Complete.pdf) (http://www.avinylfence.com/documents/BT_Install_Complete.pdf) [pdf] 2mb

[Variable Terrain Installation Instructions](http://www.avinylfence.com/documents/bufftech-variable-terrain-fence-installation.pdf) (<http://www.avinylfence.com/documents/bufftech-variable-terrain-fence-installation.pdf>) [pdf] 142kb

[Tools You'll Need](http://www.avinylfence.com/documents/bufftech-tools-youll-need.pdf) (<http://www.avinylfence.com/documents/bufftech-tools-youll-need.pdf>) [pdf] 168kb

Getting Started

- Site plans
- Measuring tape
- Hammer
- Wooden Stakes
- String line
- Spray paint for hole centers for post and gate spacing
- Wooden Spacer bar for post and gate spacing

Assembling Fence / Gates

- Hacksaw, circular saw or chop saw with masonry blade
- Square
- #3 square drive bit
- Phillips #2 screwdriver
- Drill and drill bits
 - 1/8" for #8 screws
 - 1/4" for bullet clips and drain holes
 - 5/32" for gate hardware if using aluminum insert
 - 3/8" for lock rings
- 1/2" deep socket (or nut driver) for traditional picket

Digging Holes

- Post hole digging tools
 - Shovel
 - Post hole digger
 - 10" auger for 4x4 posts
 - 12" auger for 5x5 posts

Installing Post

- Wheelbarrow
- Concrete mixing tools
- Short length of wood, 2x4 for tamping concrete
- Garden hose
- Level
- Template kit with router
- Spiral saw

Installing Bottom Rail

- Leveling blocks
- Shim stock
- Duct tape to seal rail ends

Installing Gate(s)

- Wrench
 - 7/16" for hinge nuts
- Flat screwdriver to activate hinge spring

Filing Post with Concrete

- Rubber mallet to tamp post

- Funnel for filling post
- Ladder for high fences

Lifetime Warranty

Download Entire Warranty (<http://www.avinylfence.com/documents/bufftech-limited-lifetime-warranty.pdf>) [pdf] 656 kb

What and Who Is Covered and for How Long

CertainTeed warrants to the original homeowner/consumer that its Bufftech vinyl fence products will be free from manufacturing defects - including peeling, flaking, blistering and corroding - when subject to normal and proper use.

Should any such defect occur during the lifetime of the original purchaser (and as long as the original purchaser is still living and retains ownership of the property), CertainTeed will repair or replace, at its option, the defective fence product. Except during the SureStart™ protection period, described below, CertainTeed also reserves the right to refund the amount paid by the original owner for the fence.

CertainTeed shall not be liable or responsible for labor charges or other expenses whatsoever in connection with removal or installation of either the original or replacement product.

In the event of repair or replacement under the terms of this warranty, the original warranty shall apply to the repaired or replacement fence material, and will extend for the balance of the warranty period in effect at the time the material proved defective.

The lifetime coverage offered by this warranty automatically ends upon the sale of the property or death of the last of the original owners of the property at the time of installation.

The lifetime coverage offered by this warranty is designed to cover individual homeowners only. In the case of fence material purchased by, or installed upon property owned by, corporations, governmental agencies, partnerships, trusts, religious organizations, schools, condominiums or cooperative housing arrangements, or installed on apartment building or any other type of building or premises not used by individual homeowners as their residences, the warranty period will be 30 years following the installation of the fence.

SureStart™ Protection

CertainTeed vinyl fence products are covered by SureStart protection for a period of five years following the date when installation has been completed. Under this warranty feature, CertainTeed, at no charge, will repair or replace, at its option, any fence proven to be defective during the five-year SureStart period. CertainTeed's maximum liability under SureStart will be equal to the reasonable cost to replace the defective fence at its current value, including labor.

Shipping

Shipping will come directly to you from the factory. Please Call For Shipping Lead Times. We ship worldwide and can deliver to any freight forwarder in the Continental U.S. If you don't have a freight forward company, we can help you get one.

Since we get factory direct rates, our freight costs are very reasonable. Most companies will call you before arriving to arrange a day and time for delivery. Please be sure to have a representative on site at the time of delivery.

For a shipping quote, please call 1-800-431-4720

Large shipments may be delivered on pallets and you will need to help unload the truck. A forklift is generally used to offload large shipments, but the pallets can be broken open to be offloaded by hand. Most residential deliveries will need to be offloaded by hand.

The driver is only responsible to get the order to the end of the truck. It will be your responsibility to remove it. This only applies to common carrier deliveries, not to UPS and FedEx type of deliveries.

In Case Of Damaged or Missing Goods

The factory loads the truck with the correct items and then it is the trucking company's responsibility to get it to you in good condition.

Any shortage or damage must be noted on the bill of lading at the time of delivery. If damage is found after the driver has left, the trucking company must be notified and a claim filed. Please make all claims promptly.

Frequently, an inspector will be sent out to see the damage or to note a shortage. It is your responsibility to seek reimbursement from the trucking company for any damages or shortages. We will help you in any way we can. The trucking company will provide the appropriate forms for filing a claim.

Replacement Orders

Replacement orders should be placed promptly with A Vinyl Fence and Deck Company, Inc so installation of your fence can proceed as scheduled. Please call us at 1-800-431-4720 before returning any items. You may incur a 25% restocking fee plus the cost of shipping both ways if a return order is NOT authorized.

If material is returned for credit, it will be your responsibility to package the material securely and safely. If the material is damaged, it will not be accepted by the manufacturer and no credit will be issued.

About Us (<http://www.avinylfence.com/ABUS.php>) | Contact Us

(<https://www.avinylfence.com/mm5/merchant.mvc?>

Session_ID=b8596512a9dd38e503a4d691f770353e&Screen=CTUS)



(<https://smartin.geotrust.com/smarticonprofile?Referer=http://www.avinylfence.com>)



BBB
Rating: A+

Click for
Review

(<http://www.bbb.org/sanjose/business-reviews/fence-contractors/a-vinyl-fence-in-san-jose-ca-212302#bbbsea1>)

| Shipping & Handling

(<http://www.avinylfence.com/SARP.php>)

| Returns

(<http://www.avinylfence.com/returns.php>)

| FAQs (<http://www.avinylfence.com/FAQS.php>)

| Privacy Policy

(<http://www.avinylfence.com/PRPO.php>)

(<http://www.avinylfence.com/>)



(<http://www.bbb.org/sanjose/business-reviews/fence-contractors/a-vinyl-fence-in-san-jose-ca-212302#bbbseal>)

Search

Sign In (<https://www.avinylfence.com/LOGN.php>) Get My Quote (https://www.avinylfence.com/mm5/merchant.mvc?Session_#1=6859651229003825032405117/0354exScreen=PLN1)

Subtotal: \$0.00 [View My Cart \(http://www.avinylfence.com/BASK.php\)](http://www.avinylfence.com/BASK.php)

Home (<http://www.avinylfence.com/>) Fencing ▾ (<http://www.avinylfence.com/category/vinyl-fencing.php>)

1 (800) 431-4720

Gates ▾ (<http://www.avinylfence.com/category/gates.php>) Prices ▾ (<http://www.avinylfence.com/category/prices.php>)

General Information ▾ (<http://www.avinylfence.com/category/general-info.php>)

Home (<http://www.avinylfence.com/>) > Fencing (<http://www.avinylfence.com/category/vinyl-fencing.php>) >

Big Rail - 4 Rail Horse Fence

The Truth About Vinyl Fence Wall Thickness:
Wall thickness of vinyl fence is **NOT** a true measure of strength or performance. It is touted by those who would mislead in order to make a sale. [More \(http://www.avinylfence.com/vinyl-fence-wall-thickness.php\)](http://www.avinylfence.com/vinyl-fence-wall-thickness.php)

**We Are Now Open Call Us Toll Free at 1-800-431-4720
No Phone Trees! Talk To Us Direct Now.**

[Click here to have us give you a call. \(/callMe.php\)](#)



Click on the Image Above to Enlarge

Price per linear foot as selected: **\$12.80**

Fence Height:

5 Feet ▾

Choose Number of Linear Feet or Sections:

Vinyl fencing is sold by the linear foot. The number of feet entered will be rounded up automatically to the nearest number of sections.

Section Width: 16 Feet

Enter Number of Feet:

Or Number of Sections:

Calculate

You will receive (0 feet of fencing)

Please Note: Each section includes one post and one post cap. Complete Section includes everything you need including the galvanized steel insert for bottom rail. There are no screws, brackets, or wood inside the posts like the discount stores.

Scroll Down the page for Dimensions, Gates and More Details

Specifications:

Style: Post & Rail

Fence Colors: White, Almond

Fence Height: 5'

Rails: 2" x 6" Hollow or 2" x 6" Ribbed

Installation: [Post & Rail Installation Instructions](#)

(<http://www.avinylfence.com/documents/bufftech-post-and-rail-installation.pdf>)

Fence Color:

White Almond

Next

At 54" - 60" high, this is one of our sturdiest ranch and farm fences available. Great for keeping outsiders out and the babies in.

* Our price per foot includes posts, caps, rails and all the pickets, picket caps and stainless steel fasteners (galvanized steel inserts on selected styles). When comparing prices with our competitors, be sure that ALL components are included.

You May Also Be Interested In These Related Items

Regarding Additional Posts: All fences include one post per section.

[View My Cart \(http://www.avinylfence.com/BASK.php\)](http://www.avinylfence.com/BASK.php)

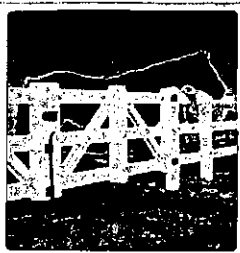

(<http://www.avinylfence.com/product/post-fence-big-4-rail-gate.php>)

(<http://www.avinylfence.com/product/post-big-4-rail.php>)

Big Rail - 4 Rail - Gate

Posts - Big 4 Rail

(<http://www.avinylfence.com/product/post-fence-big-4-rail-gate.php>)

(<http://www.avinylfence.com/product/post-big-4-rail.php>)

Prices Starting From: \$585.36

Prices Starting From: \$26.86

Product Details

Product Details

(<http://www.avinylfence.com/product/post-fence-big-4-rail-gate.php>)

(<http://www.avinylfence.com/product/post-big-4-rail.php>)

Specifications

Gates

Installation

Warranty

Shipping

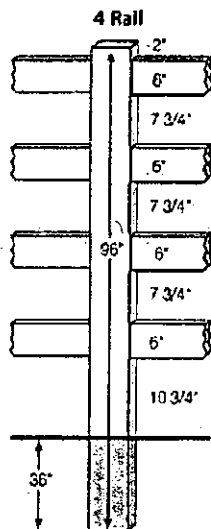

The lock ring secures the rail inside of the post.

Available in Ribbed or Hollow rail.

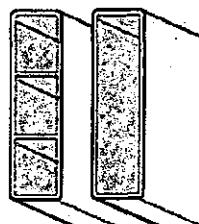
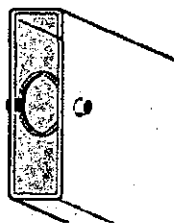

NOTE: Our rails are 16 ft. (191 1/2") long and the posts are set at 8 ft. on center which means each 16 ft. section has two posts and caps included in price. When installing the rails, we suggest that for the first section only, a 16 ft. rail be cut in two and used as the middle rail on a 3 rail fence or 2nd and 4th rail on 4 rail. Thereafter use all 16 ft. rails. This serves to make the installation stronger since the rails all terminate on alternating posts.

We currently don't have pictures of gates for this fence style. However, below is a picture from our 3 Rail horse fence gates to give you a better idea of what the gates look like.

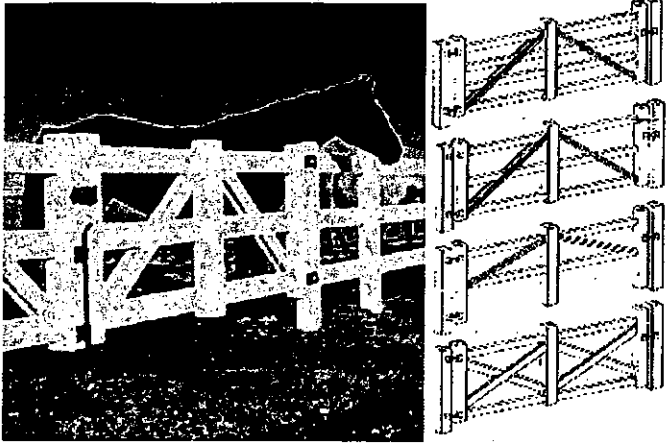

Installation Manuals & Tools You'll Need

[Bufftech Vinyl Fence Installation Instructions - Complete \(http://www.avinylfence.com/documents/BT_Install_Complete.pdf\)](http://www.avinylfence.com/documents/BT_Install_Complete.pdf) [pdf] 2mb

[Variable Terrain Installation Instructions \(http://www.avinylfence.com/documents/bufftech-variable-terrain-fence-installation.pdf\)](http://www.avinylfence.com/documents/bufftech-variable-terrain-fence-installation.pdf) [pdf] 142kb

[Tools You'll Need \(http://www.avinylfence.com/documents/bufftech-tools-youll-need.pdf\)](http://www.avinylfence.com/documents/bufftech-tools-youll-need.pdf) [pdf] 168kb

Getting Started

- Site plans
- Measuring tape
- Hammer
- Wooden Stakes
- String line
- Spray paint for hole centers for post and gate spacing
- Wooden Spacer bar for post and gate spacing

Assembling Fence / Gates

- Hacksaw, circular saw or chop saw with masonry blade
- Square
- #3 square drive bit
- Phillips #2 screwdriver
- Drill and drill bits
 - 1/8" for #8 screws
 - 1/4" for bullet clips and drain holes
 - 5/32" for gate hardware if using aluminum insert
 - 3/8" for lock rings
- 1/2" deep socket (or nut driver) for traditional picket

Digging Holes

- Post hole digging tools
 - Shovel
 - Post hole digger
 - 10" auger for 4x4 posts
 - 12" auger for 5x5 posts

Installing Post

- Wheelbarrow
- Concrete mixing tools
- Short length of wood, 2x4 for tamping concrete
- Garden hose
- Level
- Template kit with router
- Spiral saw

Installing Bottom Rail

- Leveling blocks
- Shim stock
- Duct tape to seal rail ends

Installing Gate(s)

- Wrench
 - 7/16" for hinge nuts
- Flat screwdriver to activate hinge spring

Filing Post with Concrete

- Rubber mallet to tamp post

- Funnel for filling post
- Ladder for high fences

Lifetime Warranty

Download Entire Warranty (<http://www.avinylfence.com/documents/bufftech-limited-lifetime-warranty.pdf>) [pdf] 656 kb

What and Who Is Covered and for How Long

CertainTeed warrants to the original homeowner/consumer that its Bufftech vinyl fence products will be free from manufacturing defects - including peeling, flaking, blistering and corroding - when subject to normal and proper use.

Should any such defect occur during the lifetime of the original purchaser (and as long as the original purchaser is still living and retains ownership of the property), CertainTeed will repair or replace, at its option, the defective fence product. Except during the SureStart™ protection period, described below, CertainTeed also reserves the right to refund the amount paid by the original owner for the fence.

CertainTeed shall not be liable or responsible for labor charges or other expenses whatsoever in connection with removal or installation of either the original or replacement product.

In the event of repair or replacement under the terms of this warranty, the original warranty shall apply to the repaired or replacement fence material, and will extend for the balance of the warranty period in effect at the time the material proved defective.

The lifetime coverage offered by this warranty automatically ends upon the sale of the property or death of the last of the original owners of the property at the time of installation.

The lifetime coverage offered by this warranty is designed to cover individual homeowners only. In the case of fence material purchased by, or installed upon property owned by, corporations, governmental agencies, partnerships, trusts, religious organizations, schools, condominiums or cooperative housing arrangements, or installed on apartment building or any other type of building or premises not used by individual homeowners as their residences, the warranty period will be 30 years following the installation of the fence.

SureStart™ Protection

CertainTeed vinyl fence products are covered by SureStart protection for a period of five years following the date when installation has been completed. Under this warranty feature, CertainTeed, at no charge, will repair or replace, at its option, any fence proven to be defective during the five-year SureStart period. CertainTeed's maximum liability under SureStart will be equal to the reasonable cost to replace the defective fence at its current value, including labor.

Shipping

Shipping will come directly to you from the factory. Please Call For Shipping Lead Times. We ship worldwide and can deliver to any freight forwarder in the Continental U.S. If you don't have a freight forward company, we can help you get one.

Since we get factory direct rates, our freight costs are very reasonable. Most companies will call you before arriving to arrange a day and time for delivery. Please be sure to have a representative on site at the time of delivery.

For a shipping quote, please call 1-800-431-4720

Large shipments may be delivered on pallets and you will need to help unload the truck. A forklift is generally used to offload large shipments, but the pallets can be broken open to be offloaded by hand. Most residential deliveries will need to be offloaded by hand.

The driver is only responsible to get the order to the end of the truck. It will be your responsibility to remove it. This only applies to common carrier deliveries, not to UPS and FedEx type of deliveries.

In Case Of Damaged or Missing Goods

The factory loads the truck with the correct items and then it is the trucking company's responsibility to get it to you in good condition.

Any shortage or damage must be noted on the bill of lading at the time of delivery. If damage is found after the driver has left, the trucking company must be notified and a claim filed. Please make all claims promptly.

Frequently, an inspector will be sent out to see the damage or to note a shortage. It is your responsibility to seek reimbursement from the trucking company for any damages or shortages. We will help you in any way we can. The trucking company will provide the appropriate forms for filing a claim.

Replacement Orders

Replacement orders should be placed promptly with A Vinyl Fence and Deck Company, Inc so installation of your fence can proceed as scheduled. Please call us at 1-800-431-4720 before returning any items. You may incur a 25% restocking fee plus the cost of shipping both ways if a return order is NOT authorized.

If material is returned for credit, it will be your responsibility to package the material securely and safely. If the material is damaged, it will not be accepted by the manufacturer and no credit will be issued.

[About Us \(http://www.avinylfence.com/ABUS.php\)](http://www.avinylfence.com/ABUS.php) | [Contact Us](#)

(<https://www.avinylfence.com/mm5/merchant.mvc?>

Session ID=b8596512a9dd38e503a4d691f770353e&Screen=CTUS)



(<https://smarticon.geotrust.com/smarticonprofile?Referer=http://www.avinylfence.com>)



BBB
Rating: A+

Click for
Review

(<http://www.bbb.org/sanjose/business-reviews/fence-contractors/a-vinyl-fence-in-san-jose-ca-212302#bbbseal>)

| [Shipping & Handling](#)

(<http://www.avinylfence.com/SARP.php>)

| [Returns](#)

(<http://www.avinylfence.com/returns.php>)

| [FAQs \(http://www.avinylfence.com/FAQS.php\)](#)

| [Privacy Policy](#)

(<http://www.avinylfence.com/PRPO.php>)

(<http://www.avinylfence.com/>)



(<http://www.bbb.org/sanjose/business-reviews/fence-contractors/a-vinyl-fence-in-san-jose-ca-212302#bbbseal>)

Search

Sign In (<https://www.avinylfence.com/LOGN.php>) Get My Quote (https://www.avinylfence.com/mm5/merchant.mvc?Session_Id=8859651239003865032466911770353e&Screen=DIR)

Subtotal: \$0.00 View My Cart (<http://www.avinylfence.com/BASK.php>)

Home (<http://www.avinylfence.com/>) Fencing ▾ (<http://www.avinylfence.com/category/vinyl-fencing.php>)

1 (800) 431-4720

Gates ▾ (<http://www.avinylfence.com/category/gates.php>) Prices ▾ (<http://www.avinylfence.com/category/prices.php>)

General Information ▾ (<http://www.avinylfence.com/category/general-info.php>)

Home (<http://www.avinylfence.com/>) > Fencing (<http://www.avinylfence.com/category/vinyl-fencing.php>) >

Certagrain Big Rail - 4 Rail Horse Fence - Certa Blends

The Truth About Vinyl Fence Wall Thickness: Wall thickness of vinyl

fence is **NOT** a true measure of strength or performance. It is touted by those who would mislead in order to make a sale. [More](http://www.avinylfence.com/vinyl-fence-wall-thickness.php) (<http://www.avinylfence.com/vinyl-fence-wall-thickness.php>)

We Are Now Open Call Us Toll Free at 1-800-431-4720 No Phone Trees! Talk To Us Direct Now.

[Click here to have us give you a call. \(/callMe.php\)](#)

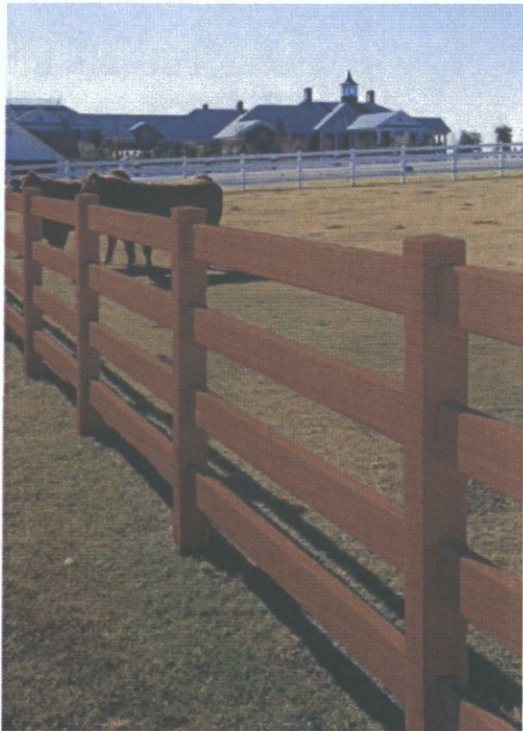

Click on the Image Above to Enlarge

Price per linear foot as selected: **\$18.13**

Fence Height:

5 Feet ▾

Fence Color:

<input checked="" type="radio"/>		<input type="radio"/>	
	Sierra Blend		Arctic Blend
<input type="radio"/>		<input type="radio"/>	
	Weathered Blend		Brazilian Blend

Choose Number of Linear Feet or Sections:

Vinyl fencing is sold by the linear foot. The number of feet entered will be rounded up automatically to the nearest number of sections.

Section Width: 12 Feet

Enter Number of Feet:

Or Number of Sections:

[Calculate](#)

You will receive (0 feet of fencing)

Please Note: Each section includes one post and one post cap. Complete Section includes everything you need including the galvanized steel insert for bottom rail. There are no screws, brackets, or wood inside the posts like the discount stores.

[Next](#)

*Our price per foot includes posts, caps, rails and all the pickets, picket caps and stainless steel fasteners (galvanized steel inserts on selected styles). When comparing prices with our competitors, be sure that ALL components are included.

Scroll Down the page for Dimensions, Gates and More Details

Specifications:

Style: Post & Rail

Fence Colors: Sierra Blend

Fence Height: 5'

Posts: 6' on Center

Rails: 2" x 6" x 12' Ribbed

Installation: [Post & Rail Installation Instructions](#)

(<http://www.avinylfence.com/documents/bufftech-post-and-rail-installation.pdf>)

You May Also Be Interested In These Related Items

[View My Cart \(http://www.avinyfence.com/BA%20K.php\)](http://www.avinyfence.com/BA%20K.php)

Regarding Additional Posts: All fences include one post per section.

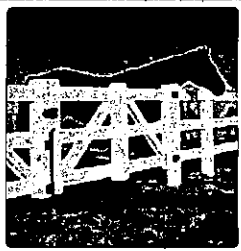

<http://www.avinyfence.com/product/horse-fence-sierra-blend-4-rail-gate.php>

Sierra Blend 4 Rail - Gate

<http://www.avinyfence.com/product/horse-fence-sierra-blend-4-rail-gate.php>

Prices Starting From: \$654.30

Product Details

<http://www.avinyfence.com/product/horse-fence-sierra-blend-4-rail-gate.php>



<http://www.avinyfence.com/product/post-sierra-blend-4-rail.php>

Posts - Sierra Blend 4 Rail

<http://www.avinyfence.com/product/post-sierra-blend-4-rail.php>

Prices Starting From: \$37.15

Product Details

<http://www.avinyfence.com/product/post-sierra-blend-4-rail.php>

Specifications

Gates

Installation

Warranty

Shipping

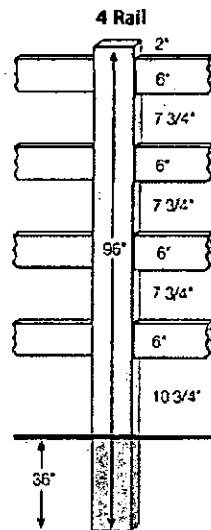

The lock ring secures the rail inside of the post.

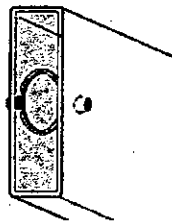

Available in Ribbed or Hollow rail.

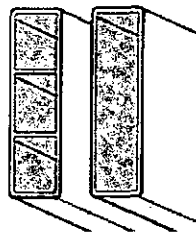

NOTE: Our rails are 12 ft. (144 ") long and the posts are set at 6 ft. on center which means each 12 ft. section has two posts and caps included in price. When installing the rails, we suggest that for the first section only, a 12 ft. rail be cut in two and used as the middle rail on a 3 rail fence or 2nd and 4th rail on 4 rail. Thereafter use all 12 ft. rails This serves to make the installation stronger since the rails all terminate on alternating posts.

We currently don't have pictures of gates for this fence style. However, below is a picture from our 3 Rail horse fence gates to give you a better idea of what the gates look like.

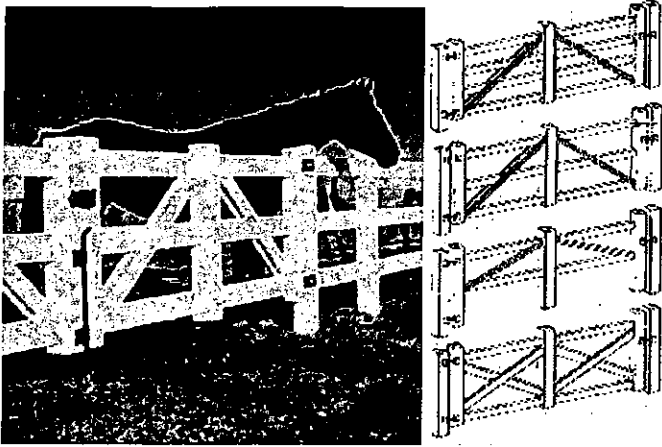

Installation Manuals & Tools You'll Need

[Bufftech Vinyl Fence Installation Instructions - Complete](http://www.avinylfence.com/documents/BT_Install_Complete.pdf) (http://www.avinylfence.com/documents/BT_Install_Complete.pdf) [pdf] 2mb

[Variable Terrain Installation Instructions](http://www.avinylfence.com/documents/bufftech-variable-terrain-fence-installation.pdf) (<http://www.avinylfence.com/documents/bufftech-variable-terrain-fence-installation.pdf>) [pdf] 142kb

[Tools You'll Need](http://www.avinylfence.com/documents/bufftech-tools-youll-need.pdf) (<http://www.avinylfence.com/documents/bufftech-tools-youll-need.pdf>) [pdf] 168kb

Getting Started

- Site plans
- Measuring tape
- Hammer
- Wooden Stakes
- String line
- Spray paint for hole centers for post and gate spacing
- Wooden Spacer bar for post and gate spacing

Assembling Fence / Gates

- Hacksaw, circular saw or chop saw with masonry blade
- Square
- #3 square drive bit
- Phillips #2 screwdriver
- Drill and drill bits
 - 1/8" for #8 screws
 - 1/4" for bullet clips and drain holes
 - 5/32" for gate hardware if using aluminum insert
 - 3/8" for lock rings
- 1/2" deep socket (or nut driver) for traditional picket

Digging Holes

- Post hole digging tools
 - Shovel
 - Post hole digger
 - 10" auger for 4x4 posts
 - 12" auger for 5x5 posts

Installing Post

- Wheelbarrow
- Concrete mixing tools
- Short length of wood, 2x4 for tamping concrete
- Garden hose
- Level
- Template kit with router
- Spiral saw

Installing Bottom Rail

- Leveling blocks
- Shim stock
- Duct tape to seal rail ends

Installing Gate(s)

- Wrench
 - 7/16" for hinge nuts
- Flat screwdriver to activate hinge spring

Filing Post with Concrete

- Rubber mallet to tamp post

- Funnel for filling post
- Ladder for high fences

Lifetime Warranty

Download Entire Warranty (<http://www.avinylfence.com/documents/bufftech-limited-lifetime-warranty.pdf>) [pdf] 656 kb

What and Who Is Covered and for How Long

CertainTeed warrants to the original homeowner/consumer that its Bufftech vinyl fence products will be free from manufacturing defects - including peeling, flaking, blistering and corroding - when subject to normal and proper use.

Should any such defect occur during the lifetime of the original purchaser (and as long as the original purchaser is still living and retains ownership of the property), CertainTeed will repair or replace, at its option, the defective fence product. Except during the SureStart™ protection period, described below, CertainTeed also reserves the right to refund the amount paid by the original owner for the fence.

CertainTeed shall not be liable or responsible for labor charges or other expenses whatsoever in connection with removal or installation of either the original or replacement product.

In the event of repair or replacement under the terms of this warranty, the original warranty shall apply to the repaired or replacement fence material, and will extend for the balance of the warranty period in effect at the time the material proved defective.

The lifetime coverage offered by this warranty automatically ends upon the sale of the property or death of the last of the original owners of the property at the time of installation.

The lifetime coverage offered by this warranty is designed to cover individual homeowners only. In the case of fence material purchased by, or installed upon property owned by, corporations, governmental agencies, partnerships, trusts, religious organizations, schools, condominiums or cooperative housing arrangements, or installed on apartment building or any other type of building or premises not used by individual homeowners as their residences, the warranty period will be 30 years following the installation of the fence.

SureStart™ Protection

CertainTeed vinyl fence products are covered by SureStart protection for a period of five years following the date when installation has been completed. Under this warranty feature, CertainTeed, at no charge, will repair or replace, at its option, any fence proven to be defective during the five-year SureStart period. CertainTeed's maximum liability under SureStart will be equal to the reasonable cost to replace the defective fence at its current value, including labor.

Shipping

Shipping will come directly to you from the factory. Please Call For Shipping Lead Times. We ship worldwide and can deliver to any freight forwarder in the Continental U.S. If you don't have a freight forward company, we can help you get one.

Since we get factory direct rates, our freight costs are very reasonable. Most companies will call you before arriving to arrange a day and time for delivery. Please be sure to have a representative on site at the time of delivery.

For a shipping quote, please call 1-800-431-4720

Large shipments may be delivered on pallets and you will need to help unload the truck. A forklift is generally used to offload large shipments, but the pallets can be broken open to be offloaded by hand. Most residential deliveries will need to be offloaded by hand.

The driver is only responsible to get the order to the end of the truck. It will be your responsibility to remove it. This only applies to common carrier deliveries, not to UPS and FedEx type of deliveries.

In Case Of Damaged or Missing Goods

The factory loads the truck with the correct items and then it is the trucking company's responsibility to get it to you in good condition.

Any shortage or damage must be noted on the bill of lading at the time of delivery. If damage is found after the driver has left, the trucking company must be notified and a claim filed. Please make all claims promptly.

Frequently, an inspector will be sent out to see the damage or to note a shortage. It is your responsibility to seek reimbursement from the trucking company for any damages or shortages. We will help you in any way we can. The trucking company will provide the appropriate forms for filing a claim.

Replacement Orders

Replacement orders should be placed promptly with A Vinyl Fence and Deck Company, Inc so installation of your fence can proceed as scheduled. Please call us at 1-800-431-4720 before returning any items. You may incur a 25% restocking fee plus the cost of shipping both ways if a return order is NOT authorized.

If material is returned for credit, it will be your responsibility to package the material securely and safely. If the material is damaged, it will not be accepted by the manufacturer and no credit will be issued.

[About Us \(http://www.avinylfence.com/ABUS.php\)](http://www.avinylfence.com/ABUS.php) | [Contact Us](#)

(<https://www.avinylfence.com/mm5/merchant.mvc?>

Session_ID=b8596512a9dd38e503a4d691f770353e&Screen=CTUS)



(<https://smarticon.geotrust.com/smarticonprofile?Referer=http://www.avinylfence.com>)



BBB
Rating: A+

Click for
Review

(<http://www.bbb.org/sanjose/business-reviews/fence-contractors/a-vinyl-fence-in-san-jose-ca-212302#bbbseal>)

| [Shipping & Handling](#)

(<http://www.avinylfence.com/SARP.php>)

| [Returns](#)

(<http://www.avinylfence.com/returns.php>)

| [FAQs \(http://www.avinylfence.com/FAQS.php\)](#)

| [Privacy Policy](#)

(<http://www.avinylfence.com/PRPO.php>)

(<http://www.avinylfence.com/>)



(<http://www.bbb.org/sanjose/business-reviews/fence-contractors/a-vinyl-fence-in-san-jose-ca-212302#bbbseal>)

Search

Sign In (<https://www.avinylfence.com/LOGN.php>) Get My Quote (<https://www.avinylfence.com/mm5/merchant.mvc?SessionID=889657&URL=/catalog/price/11/115588/Screen/CLIN>)

Subtotal: \$0.00 View My Cart (<http://www.avinylfence.com/BASK.php>)

Home (<http://www.avinylfence.com/>) Fencing ▾ (<http://www.avinylfence.com/category/vinyl-fencing.php>)

1 (800) 431-4720

Gates ▾ (<http://www.avinylfence.com/category/gates.php>) Prices ▾ (<http://www.avinylfence.com/category/prices.php>)

General Information ▾ (<http://www.avinylfence.com/category/general-info.php>)

Home (<http://www.avinylfence.com/>) > Fencing (<http://www.avinylfence.com/category/vinyl-fencing.php>) >

Tuff Stuff - 4 Rail Horse Fence

We Are Now Open Call Us Toll Free at 1-800-431-4720
No Phone Trees! Talk To Us Direct Now.
[Click here to have us give you a call. \(/callMe.php\)](#)



Click on the Image Above to Enlarge



Price per linear foot as selected: **\$12.99**

Fence Height:

4 1/2 Feet - from \$12.99 per linear foot ▾

Fence Color:

- White
- Grey
- Kentucky Black
- Weathered Wood
- Cherry Mahogany
- Green
- Brown
- Cedar

Choose Number of Linear Feet or Sections:

Vinyl fencing is sold by the linear foot. The number of feet entered will be rounded up automatically to the nearest number of sections.

Section Width: 16 Feet

Enter Number of Feet:

Or Number of Sections: [Change](#)

You will receive (0 feet of fencing)

Please Note: Each section includes one post and one post cap. Complete Section includes everything you need including the galvanized steel insert for bottom rail. There are no screws, brackets, or wood inside the posts like the discount stores.

[Next](#)

Great to use as horse, cattle and other livestock fencing with tighter spacing between the rails than the 3-rail style. At 54" high, this is the ultimate all purpose ranch and farm fence.

* Our price per foot includes posts, caps, rails and all the pickets, picket caps and stainless steel fasteners (galvanized steel inserts on selected styles). When comparing prices with our competitors, be sure that ALL componenets are included.

Scroll Down the page for Dimensions, Gates and More Details

Specifications:

Style: Post & Rail

Fence Colors: White, Grey, Kentucky Black, Weathered Wood, Cherry Mahogany, Green

Fence Height: 4 1/2'

Installation: [Post & Rail Installation Instructions](#)
(<http://www.avinylfence.com/documents/bufftech-post-and-rail-installation.pdf>)

- Specifications
- Gates
- Installation
- Warranty
- Shipping

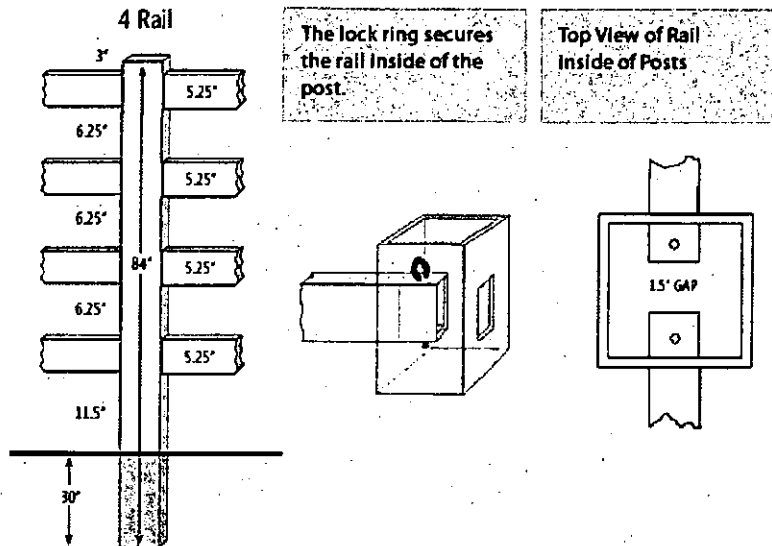

The lock ring secures the rail inside of the post.

Top View of Rail Inside of Posts

NOTE: Our rails are 16 ft. (191 1/2 ") long and the posts are set at 8 ft. on center which means each 16 ft. section has two posts and caps included in price. When installing the rails, we suggest that for the first section only, a 16 ft. rail be cut in two and used as the middle rail on a 3 rail fence or 2nd and 4th rail on 4 rail. Thereafter use all 16 ft. rails This serves to make the installation stronger since the rails all terminate on alternating posts.

We currently don't have pictures of gates for this fence style. For gate information and pricing, please call 1-800-431-4720.

Installation Manuals & Tools You'll Need

[Bufftech Vinyl Fence Installation Instructions - Complete](http://www.avinylfence.com/documents/BT_Install_Complete.pdf) (http://www.avinylfence.com/documents/BT_Install_Complete.pdf) [pdf] 2mb

[Variable Terrain Installation Instructions](http://www.avinylfence.com/documents/bufftech-variable-terrain-fence-installation.pdf) (http://www.avinylfence.com/documents/bufftech-variable-terrain-fence-installation.pdf) [pdf] 142kb

[Tools You'll Need](http://www.avinylfence.com/documents/bufftech-tools-youll-need.pdf) (http://www.avinylfence.com/documents/bufftech-tools-youll-need.pdf) [pdf] 168kb

Getting Started

- Site plans
- Measuring tape
- Hammer
- Wooden Stakes
- String line
- Spray paint for hole centers for post and gate spacing
- Wooden Spacer bar for post and gate spacing

Assembling Fence / Gates

- Hacksaw, circular saw or chop saw with masonry blade
- Square
- #3 square drive bit
- Phillips #2 screwdriver
- Drill and drill bits
 - 1/8" for #8 screws
 - 1/4" for bullet clips and drain holes
 - 5/32" for gate hardware if using aluminum insert
 - 3/8" for lock rings
- 1/2" deep socket (or nut driver) for traditional picket

Digging Holes

- Post hole digging tools
 - Shovel
 - Post hole digger
 - 10" auger for 4x4 posts
 - 12" auger for 5x5 posts

Installing Post

- Wheelbarrow
- Concrete mixing tools
- Short length of wood, 2x4 for tamping concrete
- Garden hose
- Level
- Template kit with router
- Spiral saw

Installing Bottom Rail

- Leveling blocks
- Shim stock
- Duct tape to seal rail ends

Installing Gate(s)

- Wrench
 - 7/16" for hinge nuts
- Flat screwdriver to activate hinge spring

Filling Post with Concrete

- Rubber mallet to tamp post
- Funnel for filling post
- Ladder for high fences

Tuff Stuff Limited Warranty

Download Entire Warranty (<http://www.avinylfence.com/documents/tuff-stuff-limited-warranty.pdf>) [pdf] 34 kb

The MANUFACTURER warrants to the original purchaser that, for a period of twenty (20) years from the date of retail purchase, its products will be free from defects in material and workmanship and will not split, crack, peel, rot, or be subject to wood boring insect damage. This limited warranty shall not apply to any products which have been subjected to misuse, negligence or accident, or have been used in a manner contrary to manufacturer instructions.

The MANUFACTURER sole obligation shall be to replace the quantity of its product proved to manufacturer to be defective, providing the products are properly installed and are being used as originally intended. Any claims under this Limited Warranty must be made within twenty (20) years of retail purchase of the product, must be in writing, accompanied by proof of purchase, and must include the return of the defective product, freight prepaid, to MANUFACTURER.

IT IS EXPRESSLY AGREED THAT THIS SHALL BE SOLE AND EXCLUSIVE REMEDY OF THE PURCHASER. UNDER NO CIRCUMSTANCES SHALL THE MANUFACTURER BE LIABLE FOR ANY COSTS, LOSS, EXPENSE, DAMAGES, SPECIAL DAMAGES ARISING DIRECTLY OR INDIRECTLY FROM THE USE OF THE PRODUCTS, WHETHER BASED UPON WARRANTY, CONTACT, NEGLIGENCE OR STRICT LIABILITY.

THE ABOVE EXPRESS LIMITED WARRANTIES ARE THE SOLE AND EXCLUSIVE WARRANTIES AVAILABLE TO YOU. NO OTHER EXPRESS WARRANTIES ARE MADE. ALL IMPLIED WARRANTIES INCLUDING, BUT NOT LIMITED TO, WARRANTY OF MERCHANT ABILITY AND FITNESS FOR A PARTICULAR PURPOSE OR USE ARE EXCLUDED AND DISCLAIMED.

1080 Broadway, San Jose, CA 95125
800/213-2539 408/280-7715 Fax 408/295-5291

Shipping

Shipping will come directly to you from the factory. Please Call For Shipping Lead Times. We ship worldwide and can deliver to any freight forwarder in the Continental U.S. If you don't have a freight forward company, we can help you get one.

Since we get factory direct rates, our freight costs are very reasonable. Most companies will call you before arriving to arrange a day and time for delivery. Please be sure to have a representative on site at the time of delivery.

For a shipping quote, please call 1-800-431-4720

Large shipments may be delivered on pallets and you will need to help unload the truck. A forklift is generally used to offload large shipments, but the pallets can be broken open to be offloaded by hand. Most residential deliveries will need to be offloaded by hand.

The driver is only responsible to get the order to the end of the truck. It will be your responsibility to remove it. This only applies to common carrier deliveries, not to UPS and FedEx type of deliveries.

In Case Of Damaged or Missing Goods

The factory loads the truck with the correct items and then it is the trucking company's responsibility to get it to you in good condition.

Any shortage or damage must be noted on the bill of lading at the time of delivery. If damage is found after the driver has left, the trucking company must be notified and a claim filed. Please make all claims promptly.

Frequently, an inspector will be sent out to see the damage or to note a shortage. It is your responsibility to seek reimbursement from the trucking company for any damages or shortages. We will help you in any way we can. The trucking company will provide the appropriate forms for filing a claim.

Replacement Orders

Replacement orders should be placed promptly with A Vinyl Fence and Deck Company, Inc so installation of your fence can proceed as scheduled. Please call us at 1-800-431-4720 before returning any items. You may incur a 25% restocking fee plus the cost of shipping both ways if a return order is NOT authorized.

If material is returned for credit, it will be your responsibility to package the material securely and safely. If the material is damaged, it will not be accepted by the manufacturer and no credit will be issued.

[About Us \(http://www.avinylfence.com/ABUS.php\)](http://www.avinylfence.com/ABUS.php) | [Contact Us \(https://www.avinylfence.com/mm5/merchant.mvc?\)](https://www.avinylfence.com/mm5/merchant.mvc?)

Session ID=b8596512a9dd38e503a4d691f770353e&Screen=CTUS)

| [Shipping & Handling \(http://www.avinylfence.com/SARP.php\)](http://www.avinylfence.com/SARP.php) | [Returns](http://www.avinylfence.com/returns.php)

(<http://www.avinylfence.com/returns.php>) | [FAQs \(http://www.avinylfence.com/FAQS.php\)](http://www.avinylfence.com/FAQS.php) | [Privacy Policy \(http://www.avinylfence.com/PRPO.php\)](http://www.avinylfence.com/PRPO.php)



(<https://smarcon.geotrust.com/smarconprofile?Referer=http://www.avinylfence.com>)



BBB
Rating: A+

Click for
Review

<http://www.bbb.org/sanjose/business-reviews/fence-contractors/a-vinyl-fence-in-san-jose-ca-212302#bbbseal>



Zoni Enterprises, LLC

6620 W Pinnacle Peak
Glendale, AZ 85310

8-2-16

To whom it may concern,

We have been requested to provide information regarding our business and the services we provide to the City of Scottsdale.

Zoni Enterprises, LLC, DBA No Fly Zone, (formerly K2 Livestock Services), has been providing safe effective insect control for animal housing here in Arizona and throughout the Southwest for over 28 years. We have installed systems in some of the largest horse facilities in the southwest. The fly spray systems are highly effective at controlling all types of insects, but flies and mosquitoes are our main target. The completely automatic insect control system consists of a reservoir that holds the insecticide concentrate, and a pump and motor equipped with a timer. At preset intervals a fine, atomized mist is dispensed through a tubing and nozzle network mounted to the ceiling of the facility over each horse stall. The insecticide we use is a bio degradable natural Pyrethrum. The insecticide is safe for all types of warm blooded animals and birds.

Each installation is customized to fit the facility. Generally the high density nylon tubing is secured to the metal beams with screws, with a specially designed anti -drip nozzle centered over each stall. Additional nozzles can be mounted in the alleyway as well. The reservoir is installed next to a regular 1 1/2" outlet, there is no need to hook up to a water supply; the drum is filled with a hose. The timer can be set according to individual needs, but generally a 30 second spray once every hour will give optimum protection.

As No Fly Zone is an authorized Pyranha dealer, please find enclosed a brochure describing the systems.

If you have any further questions please feel free to contact me directly at 602-399-9930.

Sincerely,
Wendy Fritz

Flyspraybarn.com
flyspraybarn@gmail.com
No Fly Zone

40-DR-2016
8/12/16

NO FLY ZONE SYSTEM - PRODUCT DATA

Our Company

No Fly Zone

Zoni Enterprises, LLC

(Formerly K2 Livestock Services)

Our company is currently celebrating our 25th anniversary!

Owner, Wendy Fritz, knows first-hand the need for automatic insect control for livestock that is safe and economical. She owns and operates a full service boarding and training facility. We not only manufacture the No Fly Zone Automatic Insect Control Systems, we use them in our own facility every day! Years of research and some trial and error have led to a trouble-free insect control system and an extremely effective and safe insecticide.

This system has been trusted for 25 years by some of the biggest ranches in the Southwest to protect their valuable equine inhabitants. Barns with every breed, and specializing in every discipline, have installed our automatic insect control systems and use the specially formulated insecticide for their insect control programs.

Call today for a free, no obligation price quote...

Call your authorized sales agent today!

... because your valuable livestock deserves the best!



Zoni Enterprises, LLC

623-561-0017 / 602-399-9930

6620 W. Pinnacle Peak
Glendale, AZ 85310

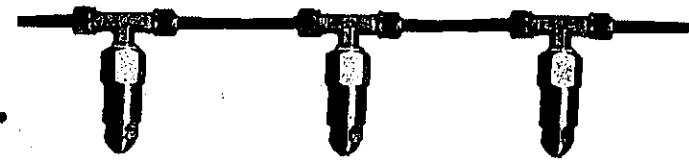

Automatic Fly Control Systems

SALES

SERVICE

INSECTICIDE

Protecting your valuable livestock and family from disease carrying flies and mosquitos since 1982.

No Fly Zone

www.Autoflycontrol.com

623-561-0017 / 602-399-9930
6620 W. Pinnacle Peak
Glendale, AZ 85310

Save Money

At Zoni Enterprises we build our own units. You eliminate the middle man by buying direct from the manufacturer. Our high quality parts and workmanship give you years of efficient, trouble-free service. As a local business with a twenty five year record here in Arizona, we stand behind our products and service.

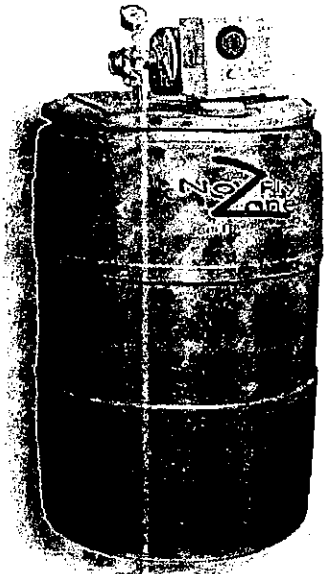

Super System Automatic Fly Control Unit

A simple to operate dual timer is located on top for easy access. The Super System will run up to 60 nozzles. Each nozzle has a check valve to prevent dripping. The non-corrosive brass pump and 1/3 HP motor are mounted on a 55 gal. poly-drum with a convenient port for easy fill-ups.

Save Labor

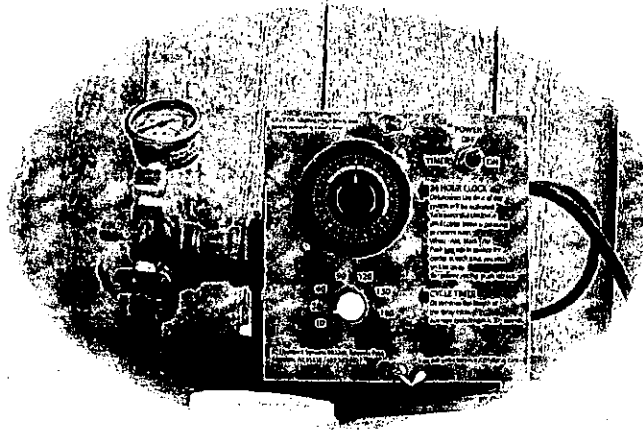

Automatic Timers

The Super System is fully automatic. Once you set the solid state timers, the Super System does the rest, covering your facility with an atomized mist of safe, effective, insecticide that kills disease carrying flies and mosquitoes automatically. You can rest assured that your stock is protected even when you are away. No individual spraying of stock or premise is required. Easily customized spray times let you decide when to spray and for how long.

When it comes time to fill your system, a call to No Fly Zone will bring a "horse-savvy" technician to do the job. No other maintenance is required!

Save Worry

Our water-based, natural pyrethrum, EPA approved insecticide is safe and effective. It is bio-degradable, and safe for pets, birds and livestock. It has been formulated specifically for use in overhead fly control systems so it will not damage your pump or plug your nozzles. Insects can expose your livestock to infections and disease. By reducing your mosquito and fly population you help protect your horses from many diseases including West Nile Virus, Sleeping Sickness and Potomac Horse fever.

FAQ's

- Q. - How much insecticide will I use?
A. - Approx 1 gallon (diluted) per nozzle, per month, depending on spray times.
- Q. - How often can I spray?
A. - The timers allow you to spray every 1/2 hour. the most common setting is every other hour for 45 seconds.
- Q. - What type of tubing do you use?
A. - All tubing is a high density thermo-plastic nylon.
- Q. - What type of power supply is needed?
A. - A standard 110 outlet is all that is needed.
- Q. - How long will my system last?
A. - We have systems still working great after 20 years!
- Q. - What maintenance is required?
A. - System requires NO regular maintenance.



FLY SPRAY BARN

6620 W Pinnacle Peak Glendale AZ 85310

602-399-9930

Wendy@flyspraybarn.com

Shop (/products) / Hago Misting Nozzle Tip 4023



HAGO MISTING NOZZLE TIP 4023

~~\$10.00~~ \$8.00 Free Shipping!

★★★★★ 1 Review

QTY

1

Add to Cart

HAGO 4023 MISTING NOZZLE TIP REPLACEMENT

Danfoss Hago's 4023 nozzle is the industry standard in pest control. Its internal "no drip" design, precise flow metering and optimal spray patterns make it perfect for Mosquito Misting Systems & Barn Fly Spray Systems utilizing water based insecticides.

SPECIFICATIONS

- 0.75 GPH @ 160 PSI
- 410 Stainless Steel Nickel-Silver Plated
- O-Ring: Viton
- Filter: Simined Bronze rated @ 31-40 microns
- Produces a Finely Atomized Mist
- Immediate Mist Cut-Off

REVIEWS

Reviews by (http://my.yotpo.com/landing_page?redirect=https%3A%2F%2Fwww.yotpo.com%2Fverified-product-reviews-by-yotpo&utm_campaign=branding_link_reviews_widget_v2&utm_medium=widget&utm_source=flyspraybarn.com)

(http://my.yotpo.com/landing_page?redirect=https%3A%2F%2Fwww.yotpo.com%2Fverified-product-reviews-by-yotpo&utm_campaign=branding_link_reviews_widget_v2&utm_medium=widget&utm_source=flyspraybarn.com)

★★★★★ 1 Review

WRITE A REVIEW

Reviews (1)

Casandra G. Verified Buyer
★★★★★

07/11/16

Awesome service

Always have had fast service & this was the first time I used shipping. Very pleased with how fast I received the nozzles. Thank you!
(<https://yotpo.com/go/xyxeq8q2>)

Was This Review Helpful? 0 0

FEATURED PRODUCTS



(<http://facebook.com/horseflyspray>)

[Home \(/\)](#)

[Shop \(/products\)](#)

[About Us \(/about\)](#)

[Contact Us \(/contact\)](#)

[Terms \(/terms\)](#)

Copyright © 2016 Fly Spray Barn



Shop (/products) / VamPyre Mistng Concentrate, Natural Pyrethrin- One gallon

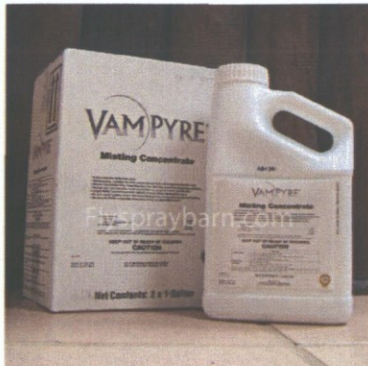

VAMPYRE MISTING CONCENTRATE, NATURAL PYRETHRIN- ONE GALLON

\$225.00 \$200.00 Free Shipping!

☆☆☆☆☆Write a review

QTY

1

Add to Cart

VAMPYRE® MISTING CONCENTRATE

Hard-to-Kill Pest Control Made Easy

Ideal for hard-to-kill flying insects and where metabolic resistance is suspected.

- Repels Stable Flies, Horse Flies, Face Flies, Deer Flies, House Flies and Gnats
- Kills Mosquitoes that may carry and transmit the West Nile
- Controls Deer Ticks that may carry and transmit Lyme disease

One gallon to fill your 55 Gallon drum

Vampyre Label (http://www.mgk.com/wp-content/uploads/2013/06/Vampyre_Specimen_Label.pdf)

2

REVIEWS

Reviews by (http://my.yotpo.com/landing_page?redirect=https%3A%2F%2Fwww.yotpo.com%2Fverified-product-reviews-by-yotpo&utm_campaign=branding_link_reviews_widget_v2&utm_medium=widget&utm_source=flyspraybarn.com)

(http://my.yotpo.com/landing_page?redirect=https%3A%2F%2Fwww.yotpo.com%2Fverified-product-reviews-by-yotpo&utm_campaign=branding_link_reviews_widget_v2&utm_medium=widget&utm_source=flyspraybarn.com)

☆☆☆☆☆

WRITE A REVIEW

★★★★★

BE THE FIRST TO WRITE A REVIEW

FEATURED PRODUCTS



(<http://facebook.com/horseflyspray>)

[Home \(/\)](#)

[Shop \(/products\)](#)

[About Us \(/about\)](#)

[Contact Us \(/contact\)](#)

[Terms \(/terms\)](#)

Copyright © 2016 Fly Spray Barn



Shop (/products) / Troika Misting Concentrate

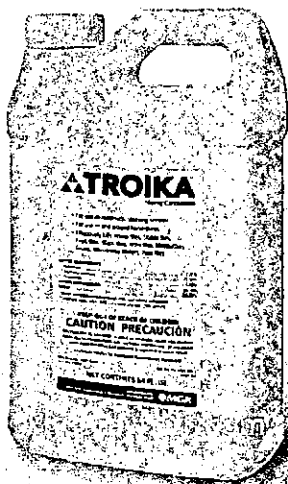

TROIKA MISTING CONCENTRATE

\$200.00 \$172.00 Free Shipping!

☆☆☆☆☆ Write a review

QTY

1

Add to Cart

TROIKA™ MISTING CONCENTRATE

BID FAREWELL TO HARD-TO-KILL FLIES AND OTHER FLYING PESTS

The powerful combination of active ingredients delivers quick knockdown and kill of the toughest flying pests in large animal settings.

- Designed for use in automatic spraying systems
- Ideal in and around horse barns, residential areas and zoo animal quarters
- Effectively kills flies, mosquitoes and gnats
- Ideal for hard-to-kill flies
- Provides quick knockdown and kill of mosquitoes
- Will not harm most common ornamental plants
- Convenient package size

Troika Label (http://www.mgk.com/wp-content/uploads/2015/04/14-MGK-0528_Troika-Specimen-Label.pdf)

3

REVIEWS

Reviews by (http://my.yotpo.com/landing_page?redirect=https%3A%2F%2Fwww.yotpo.com%2Fverified-product-reviews-by-yotpo&utm_campaign=branding_link_reviews_widget_v2&utm_medium=widget&utm_source=flyspraybarn.com)

(http://my.yotpo.com/landing_page?redirect=https%3A%2F%2Fwww.yotpo.com%2Fverified-product-reviews-by-yotpo&utm_campaign=branding_link_reviews_widget_v2&utm_medium=widget&utm_source=flyspraybarn.com)

☆☆☆☆☆

WRITE A REVIEW



BE THE FIRST TO WRITE A REVIEW

FEATURED PRODUCTS



(<http://facebook.com/horseflyspray>)

[Home \(/\)](#)

[Shop \(/products\)](#)

[About Us \(/about\)](#)

[Contact Us \(/contact\)](#)

[Terms \(/terms\)](#)

Copyright © 2016 Fly Spray Barn



Shop /products/ / Sector Misting Concentrate 64 OZ

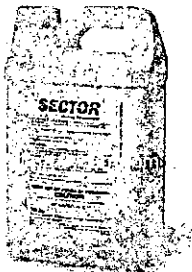

SECTOR MISTING CONCENTRATE 64 OZ

\$95.00 \$65.00 Free Shipping!

☆☆☆☆☆ Write a review

QTY

1

Add to Cart

SECTOR® MISTING CONCENTRATE

YOUR FIRST LINE OF DEFENSE

Sector® provides effective, economical protection against a broad spectrum of flying pests

- Combines Permethrin with the synergist PBO for a higher level of performance
- Water-based polymeric surfactant system is stable in solution
- Will not harm most common ornamental plants

1 quart to fill your 55 gallon drum

Sector Label (http://www.mgk.com/wp-content/uploads/2013/06/Sector_Specimen_Label.pdf)

0

REVIEWS

Reviews by (http://my.yotpo.com/landing_page?redirect=https%3A%2F%2Fwww.yotpo.com%2Fverified-product-reviews-by-yotpo&utm_campaign=branding_link_reviews_widget_v2&utm_medium=widget&utm_source=flyspraybarn.com)

Ⓢ (http://my.yotpo.com/landing_page?redirect=https%3A%2F%2Fwww.yotpo.com%2Fverified-product-reviews-by-yotpo&utm_campaign=branding_link_reviews_widget_v2&utm_medium=widget&utm_source=flyspraybarn.com)

☆☆☆☆☆

WRITE A REVIEW

★★★★★

BE THE FIRST TO WRITE A REVIEW

FEATURED PRODUCTS



(<http://facebook.com/horseflyspray>)

[Home \(/\)](#)

[Shop \(/products\)](#)

[About Us \(/about\)](#)

[Contact Us \(/contact\)](#)

[Terms \(/terms\)](#)

Copyright © 2016 Fly Spray Barn



Shop (/products) / Tee Nozzle

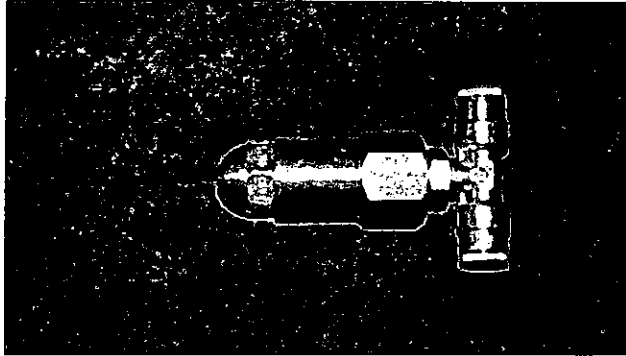

TEE NOZZLE

\$21.00 Free Shipping

☆☆☆☆☆ Write a review

QTY

1

Add to Cart

Camozi Straight Tee Nozzle with Hago Spray Tip

0

REVIEWS

Reviews by (http://my.yotpo.com/landing_page?redirect=https%3A%2F%2Fwww.yotpo.com%2Fverified-product-reviews-by-yotpo&utm_campaign=branding_link_reviews_widget_v2&utm_medium=widget&utm_source=flyspraybarn.com)

(http://my.yotpo.com/landing_page?redirect=https%3A%2F%2Fwww.yotpo.com%2Fverified-product-reviews-by-yotpo&utm_campaign=branding_link_reviews_widget_v2&utm_medium=widget&utm_source=flyspraybarn.com)

☆☆☆☆☆

WRITE A REVIEW

☆☆☆☆☆

BE THE FIRST TO WRITE A REVIEW

FEATURED PRODUCTS

 Free Shipping!

VamPyre Misting Concentrate, Natural Pyrethrim- One gallon

~~\$225.00~~ \$200.00

[\(/products/vampyre\)](/products/vampyre)

 Free Shipping!

Sector Misting Concentrate 64 OZ

~~\$95.00~~ \$65.00

[\(/products/sector-misting-concentrate-64-oz\)](/products/sector-misting-concentrate-64-oz)

 Free Shipping!

Troika Misting Concentrate

~~\$200.00~~ \$172.00

[\(/products/troika-misting-concentrate\)](/products/troika-misting-concentrate)

 Free Shipping!

Hago Misting Nozzle Tip 4023

~~\$10.00~~ \$8.00

★★★★★

[\(/products/hago-nozzle-tip-4030\)](/products/hago-nozzle-tip-4030)



[\(http://facebook.com/horseflyspray\)](http://facebook.com/horseflyspray)

[Home \(/\)](#)

[Shop \(/products\)](/products)

[About Us \(/about\)](/about)

[Contact Us \(/contact\)](/contact)

[Terms \(/terms\)](/terms)

Copyright © 2016 Fly Spray Barn



Shop (/products) / 1/4 black 500 Foot Roll



1/4 BLACK 500 FOOT ROLL

\$145.00 Free Shipping!

☆☆☆☆☆ Write a review

QTY

1

Add to Cart

1/4 black 500 Foot Roll

0

REVIEWS

Reviews by (http://my.yotpo.com/landing_page?redirect=https%3A%2F%2Fwww.yotpo.com%2Fverified-product-reviews-by-yotpo&utm_campaign=branding_link_reviews_widget_v2&utm_medium=widget&utm_source=flyspraybarn.com)

(http://my.yotpo.com/landing_page?redirect=https%3A%2F%2Fwww.yotpo.com%2Fverified-product-reviews-by-yotpo&utm_campaign=branding_link_reviews_widget_v2&utm_medium=widget&utm_source=flyspraybarn.com)

☆☆☆☆☆

WRITE A REVIEW

★★★★★

BE THE FIRST TO WRITE A REVIEW

FEATURED PRODUCTS

 Free Shipping!

VamPyre Misting Concentrate, Natural Pyrethrin- One gallon
~~\$225.00~~ \$200.00

[\(/products/vampyre\)](/products/vampyre)

 Free Shipping!

Sector Misting Concentrate 64 OZ
~~\$95.00~~ \$65.00

[\(/products/sector-misting-concentrate-64-oz\)](/products/sector-misting-concentrate-64-oz)

 Free Shipping!

Troika Misting Concentrate
~~\$200.00~~ \$172.00

[\(/products/troika-misting-concentrate\)](/products/troika-misting-concentrate)

 Free Shipping!

Hago Misting Nozzle Tip 4023
~~\$10.00~~ \$8.00

★★★★★
[\(/products/hago-nozzle-tip-4030\)](/products/hago-nozzle-tip-4030)



<http://facebook.com/horseflyspray>

[Home \(/\)](#)

[Shop \(/products\)](/products)

[About Us \(/about\)](/about)

[Contact Us \(/contact\)](/contact)

[Terms \(/terms\)](/terms)

Copyright © 2016 Fly Spray Barn



Shop (/products) / Pyranha SprayMaster Misting System - 55 Gallon Unit With Battery Back Up



PYRANHA SPRAYMASTER MISTING SYSTEM - 55 GALLON UNIT WITH BATTERY BACK UP

~~\$950.00~~ \$922.00 Free Shipping!

☆☆☆☆☆ Write a review

QTY

1

Add to Cart

Pyranha SprayMaster

55 Gallon SprayMaster System Only

The SprayMaster is a 1/2 horsepower electric motor-driven pump controlled by a solid state electronic timer that is programmed to dispense an insecticide formulation in the form of a very fine mist at specific intervals through special spray nozzles. The result is a state of the art, hassle-free solution to control of harmful flying and biting insects in and around horse barns.

The automatically timed spray intervals of the Spray Master help keep your barn virtually fly free. Easy to install with basic tools. Expandable up to 80 stalls. Can be used with Insecticide or ODAWAY Odor Absorber. One Year Limited Manufacturer's Warranty on polyethylene drum, motor, pump, automatic timer, pressure gauge, by-pass valve and connections.

This system comes with:

- Polyethylene 55 gallon drum
- Motor Pump
- Automatic timer
- Pressure gauge
- By-pass valve
- Connections
- Instructions

Please Note: Insecticide concentrate, tubing and nozzles sold separately. System is expandable up to 80 stalls with purchase of additional tubing and nozzles.

REVIEWS

Reviews by (http://my.yotpo.com/landing_page?redirect=https%3A%2F%2Fwww.yotpo.com%2Fverified-product-reviews-by-yotpo&utm_campaign=branding_link_reviews_widget_v2&utm_medium=widget&utm_source=flyspraybarn.com)

(http://my.yotpo.com/landing_page?redirect=https%3A%2F%2Fwww.yotpo.com%2Fverified-product-reviews-by-yotpo&utm_campaign=branding_link_reviews_widget_v2&utm_medium=widget&utm_source=flyspraybarn.com)

☆☆☆☆☆

WRITE A REVIEW

★★★★★

BE THE FIRST TO WRITE A REVIEW

FEATURED PRODUCTS



(<http://facebook.com/horseflyspray>)

[Home \(/\)](#)

[Shop \(/products\)](#)

[About Us \(/about\)](#)

[Contact Us \(/contact\)](#)

[Terms \(/terms\)](#)

Copyright © 2016 Fly Spray Barn



Shop /products/ / Elbow Tee Complete Assembly



ELBOW TEE COMPLETE ASSEMBLY

\$21.00 Free Shipping

☆☆☆☆☆ Write a review

QTY

1

Add to Cart

End Nozzle with Hago Spray Tip

0

REVIEWS

Reviews by (http://my.yotpo.com/landing_page?redirect=https%3A%2F%2Fwww.yotpo.com%2Fverified-product-reviews-by-yotpo&utm_campaign=branding_link_reviews_widget_v2&utm_medium=widget&utm_source=flyspraybarn.com)

(http://my.yotpo.com/landing_page?redirect=https%3A%2F%2Fwww.yotpo.com%2Fverified-product-reviews-by-yotpo&utm_campaign=branding_link_reviews_widget_v2&utm_medium=widget&utm_source=flyspraybarn.com)

☆☆☆☆☆

WRITE A REVIEW

★★★★★

BE THE FIRST TO WRITE A REVIEW

FEATURED PRODUCTS

 Free Shipping!

VamPyre Mistng Concentrate, Natural Pyrethrim- One gallon
~~\$225.00~~ \$200.00

[\(/products/vampyre\)](/products/vampyre)

 Free Shipping!

Sector Mistng Concentrate 64 OZ
~~\$95.00~~ \$65.00

[\(/products/sector-misting-concentrate-64-oz\)](/products/sector-misting-concentrate-64-oz)

 Free Shipping!

Troika Mistng Concentrate
~~\$200.00~~ \$172.00

[\(/products/troika-misting-concentrate\)](/products/troika-misting-concentrate)

 Free Shipping!

Hago Mistng Nozzle Tip 4023
~~\$10.00~~ \$8.00
★★★★★

[\(/products/hago-nozzle-tip-4030\)](/products/hago-nozzle-tip-4030)



[\(http://facebook.com/horseflyspray\)](http://facebook.com/horseflyspray)

[Home \(/\)](#)

[Shop \(/products\)](/products)

[About Us \(/about\)](/about)

[Contact Us \(/contact\)](/contact)

[Terms \(/terms\)](/terms)

Copyright © 2016 Fly Spray Barn



Shop (/products) / More Fly Spray Products Coming Soon!



MORE FLY SPRAY PRODUCTS COMING SOON!

\$1.00

☆☆☆☆☆Write a review

QTY

1

Add to Cart

Check back soon for more Insect Control Products

Please contact us and let us know what types of products you would like to see.

0

REVIEWS

Reviews by (http://my.yotpo.com/landing_page?redirect=https%3A%2F%2Fwww.yotpo.com%2Fverified-product-reviews-by-yotpo&utm_campaign=branding_link_reviews_widget_v2&utm_medium=widget&utm_source=flyspraybarn.com)

 (http://my.yotpo.com/landing_page?redirect=https%3A%2F%2Fwww.yotpo.com%2Fverified-product-reviews-by-yotpo&utm_campaign=branding_link_reviews_widget_v2&utm_medium=widget&utm_source=flyspraybarn.com)

☆☆☆☆☆

WRITE A REVIEW

★★★★★

BE THE FIRST TO WRITE A REVIEW

FEATURED PRODUCTS

 Free Shipping!

VamPyre Mistig Concentrate, Natural Pyrethrim- One gallon

~~\$225.00~~ \$200.00

[\(/products/vampyre\)](/products/vampyre)

 Free Shipping!

Sector Mistig Concentrate 64 OZ

~~\$95.00~~ \$65.00

[\(/products/sector-misting-concentrate-64-oz\)](/products/sector-misting-concentrate-64-oz)

 Free Shipping!

Troika Mistig Concentrate

~~\$200.00~~ \$172.00

[\(/products/troika-misting-concentrate\)](/products/troika-misting-concentrate)

 Free Shipping!

Hago Mistig Nozzle Tip 4023

~~\$10.00~~ \$8.00

★★★★★

[\(/products/hago-nozzle-tip-4030\)](/products/hago-nozzle-tip-4030)



<http://facebook.com/horseflyspray>

[Home \(/\)](#)

[Shop \(/products\)](/products)

[About Us \(/about\)](/about)

[Contact Us \(/contact\)](/contact)

[Terms \(/terms\)](/terms)

Copyright © 2016 Fly Spray Barn



Shop (/products) / Pyranha 1-10PX Fly Spray Concentrate 1/2 Gallon



PYRANHA 1-10PX FLY SPRAY CONCENTRATE 1/2 GALLON

\$69.95 Free Shipping!

☆☆☆☆☆ Write a review

QTY

1

Add to Cart

For use in automatic spray systems in residential backyards - animal quarters - barns - dairies - milking parlors - and more Kills mosquitoes that may cause west nile virus and eastern western and st louis equine encephalitis Will not harm most common ornament: Size: 64 FLUID oz

0

REVIEWS

Reviews by (http://my.yotpo.com/landing_page?redirect=https%3A%2F%2Fwww.yotpo.com%2Fverified-product-reviews-by-yotpo&utm_campaign=branding_link_reviews_widget_v2&utm_medium=widget&utm_source=flyspraybarn.com)

(http://my.yotpo.com/landing_page?redirect=https%3A%2F%2Fwww.yotpo.com%2Fverified-product-reviews-by-yotpo&utm_campaign=branding_link_reviews_widget_v2&utm_medium=widget&utm_source=flyspraybarn.com)

☆☆☆☆☆

WRITE A REVIEW

★★★★★

BE THE FIRST TO WRITE A REVIEW

FEATURED PRODUCTS

 [Fly Spray Barn](#)

[View Pyranha 1-10PX Fly Spray Concentrate 1/2 Gallon](#)

~~\$\$\$6.00~~ \$200.00

[/products/wampyct](#)

 [Fly Spray Barn](#)

[View Pyranha 1-10PX Fly Spray Concentrate 1/2 Gallon](#)

~~\$\$\$6.00~~ \$65.00

[/products/wampyct](#)

 [Fly Spray Barn](#)

[View Pyranha 1-10PX Fly Spray Concentrate 1/2 Gallon](#)

~~\$\$\$6.00~~ \$172.00

[/products/wampyct](#)

 [Fly Spray Barn](#)

[View Pyranha 1-10PX Fly Spray Concentrate 1/2 Gallon](#)

~~\$\$\$6.00~~ \$9.00

★★★★★

[/products/wampyct](#)



(<http://facebook.com/horseflyspray>)

[Home \(/\)](#)

[Shop \(/products\)](#)

[About Us \(/about\)](#)

[Contact Us \(/contact\)](#)

[Terms \(/terms\)](#)

Copyright © 2016 Fly Spray Barn



Shop (products) / Pyranha Odaway Odor Absorber Concentrate

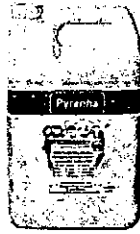

PYRANHA ODAWAY ODOR ABSORBER CONCENTRATE

~~564.00~~ \$46.00 Free Shipping!

☆☆☆☆☆ Write a review

QTY:

Pyranha Odaway Odor Absorber Concentrate is a product that gets rid of any persistent odor. The liquid concentrate works by using a botanical enzyme that absorbs the odor and neutralizes it. It has many uses, from taking skunk musk off of your dog to getting the body odor out of your favorite clothes. It can even clear the space between your walls of the smell of decaying rodents that accompany a successful rodenticide application. Not-toxic and biodegradable, 1 gallon of Odaway Odor Absorber Concentrate makes 55 gallons of solution for application. Apply either through a misting system or a direct spray. Works best with automatic misting systems such as the Pyranha SprayMaster Misting System - 55 Gallon Unit With Battery Back Up. This will neutralize and encapsulate the odor instead of masking it. Keep your house and barn smelling fresh!

1

REVIEWS

Reviews by (http://my.yotpo.com/landing_page?redirect=https%3A%2F%2Fwww.yotpo.com%2Fverified-product-reviews-by-yotpo&utm_campaign=branding_link_reviews_widget_v2&utm_medium=widget&utm_source=flyspraybarn.com)

(http://my.yotpo.com/landing_page?redirect=https%3A%2F%2Fwww.yotpo.com%2Fverified-product-reviews-by-yotpo&utm_campaign=branding_link_reviews_widget_v2&utm_medium=widget&utm_source=flyspraybarn.com)

☆☆☆☆☆

WRITE A REVIEW

★★★★★

BE THE FIRST TO WRITE A REVIEW

FEATURED PRODUCTS



(<http://facebook.com/horseflyspray>)

[Home \(/\)](#)

[Shop \(/products\)](#)

[About Us \(/about\)](#)

[Contact Us \(/contact\)](#)

[Terms \(/terms\)](#)

Copyright © 2016 Fly Spray Barn



Centaur Equinecisers



& Hot Walkers

40-DR-2016
8/12/16

5761 Ridgeview Ave., Mira Loma, Ca. 91752 * 800-962-8050 * (951) 685-7337 * (951) 685-0341 Fax
www.equinecisers.com * centaur@equinecisers.com

EUROCISER/HOTWALKER - PRODUCT DATA

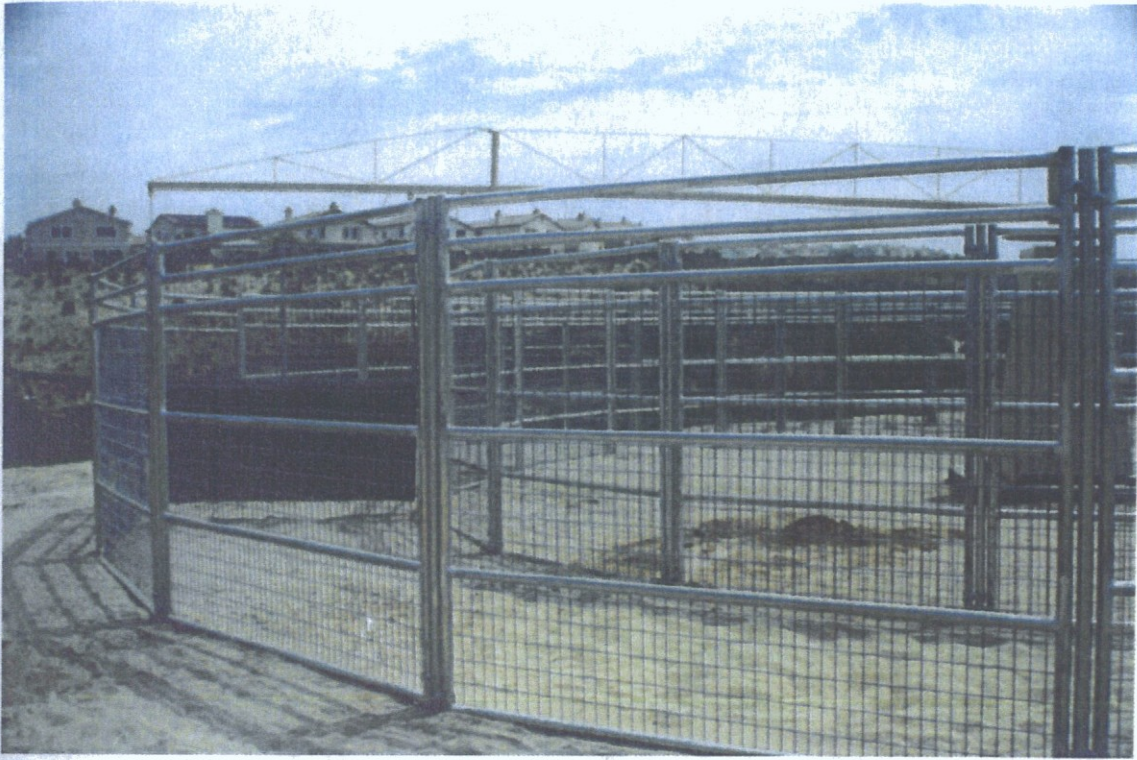

Standard Inside & Outside Fencing full assembled.



Standard Inside & Outside Fencing full assembled. Width between fences is 8 ft.

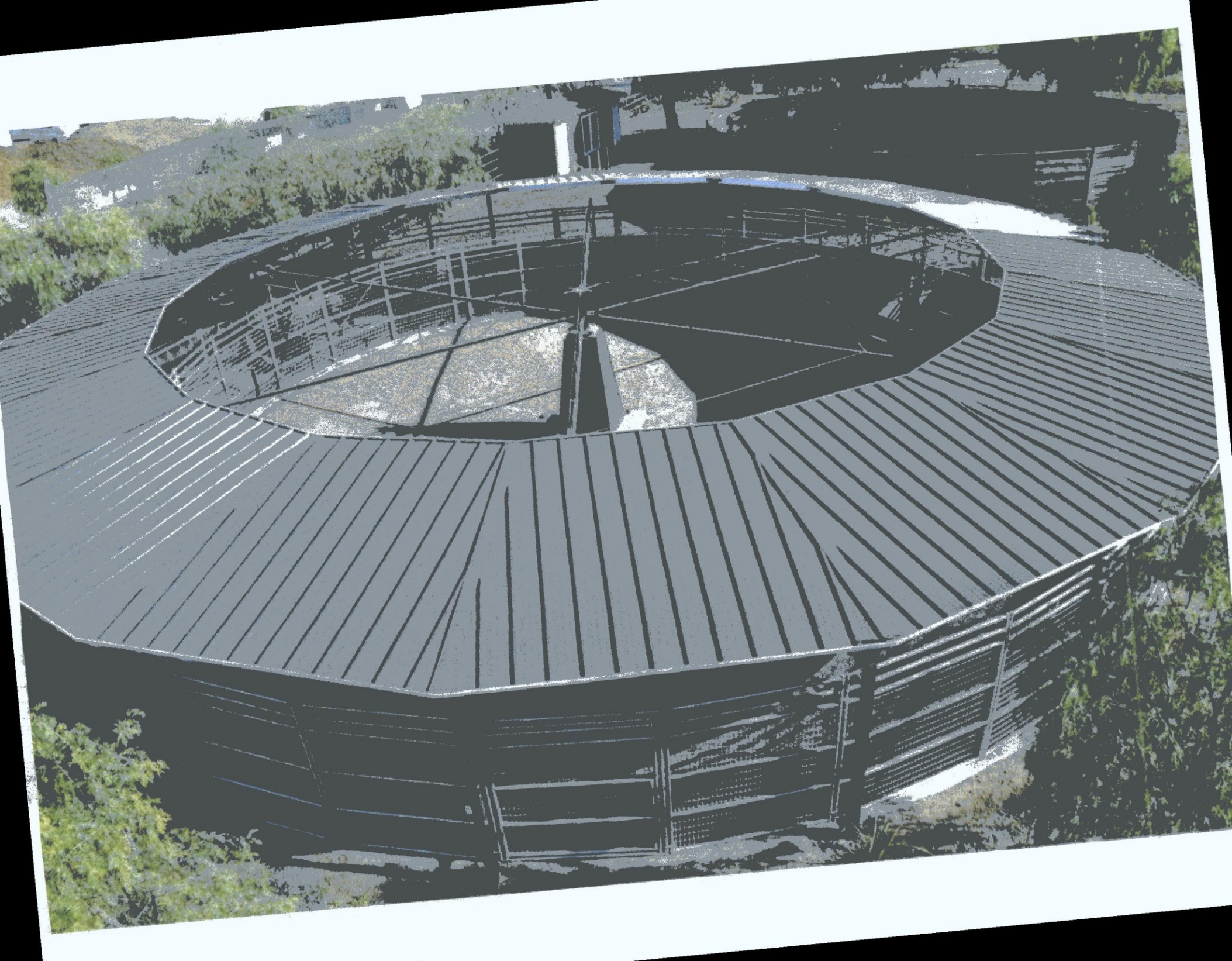

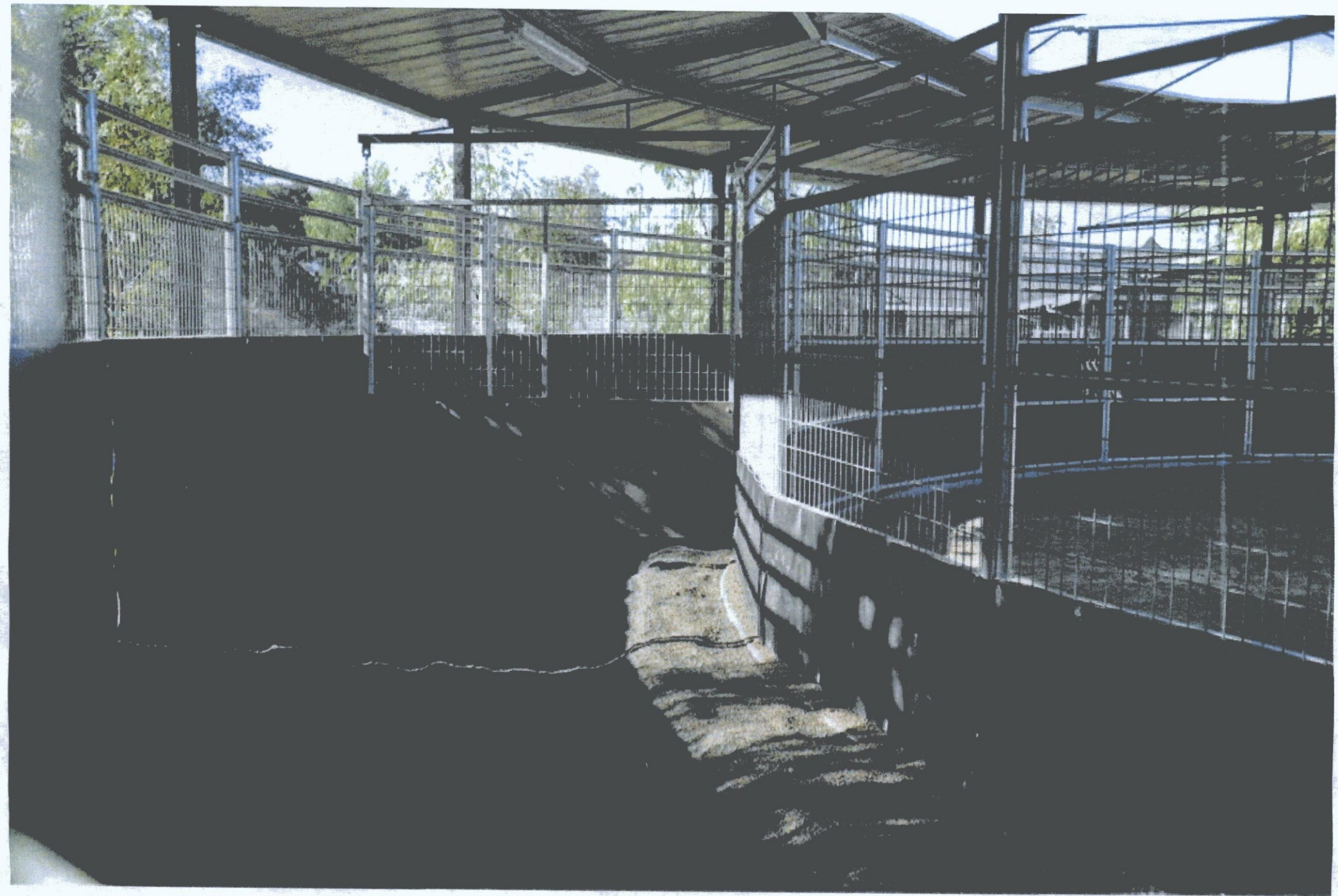





Close Up of open main gate. 6 ft. wide, 8 ft. tall. Shown with optional 5 ft. soil retention system.

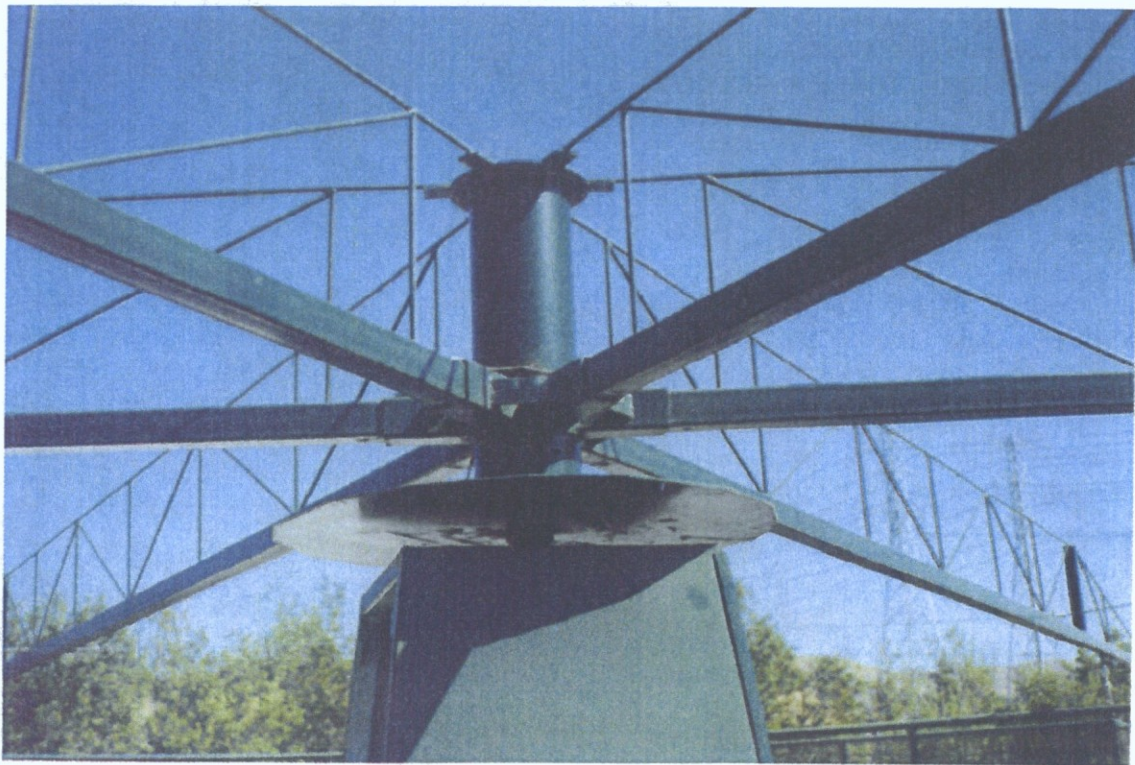

Head assembly for a 6 horse model Equineciser.



Interior view showing: Motor, Gearbox, Falk Coupling & Computerized Controller.



Control Box with individual controls for: Start/Stop, Screen Shocker On/Off, Forward/Reverse, and Adjustable Speed Control



Close up of closed main gate. 6 ft. wide
8 ft. tall. Shown with optional 5 ft. soil
retention system.



Close up of open interior service gate,
4 ft. wide, 8 ft. tall.

Spring loaded bullet latch shown in each picture is lockable.



Electrified Divider Screen, galvanized welded wire, welded to square structural steel. Screens are 7 ft. wide, 3 ft tall. Rubber kick matting is 3 ft. tall.

Divider screen is attached with quick links to allow you to raise or lower the screen to adjust for your footing. Quick links also allow screen to pass over horse should he/she fall.

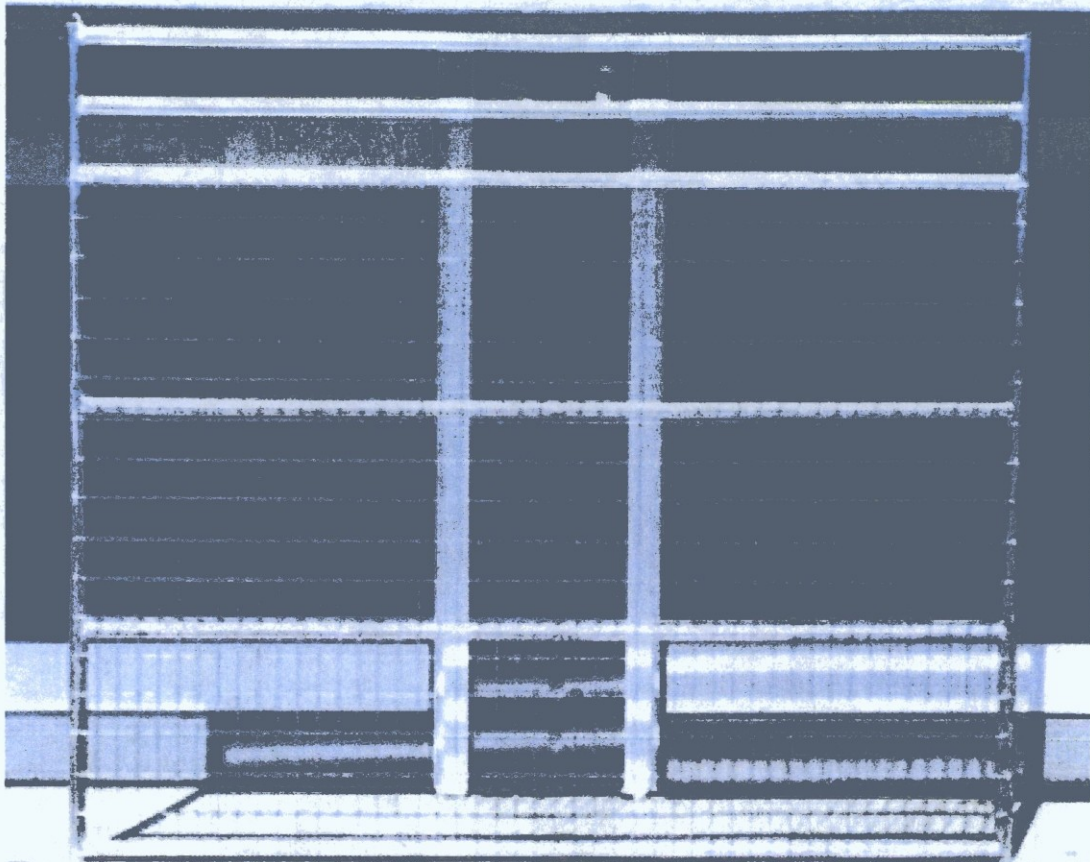

STANDARD ENCLOSURE PANEL. PANEL IS 7' TALL AND 6' IN LENGTH.

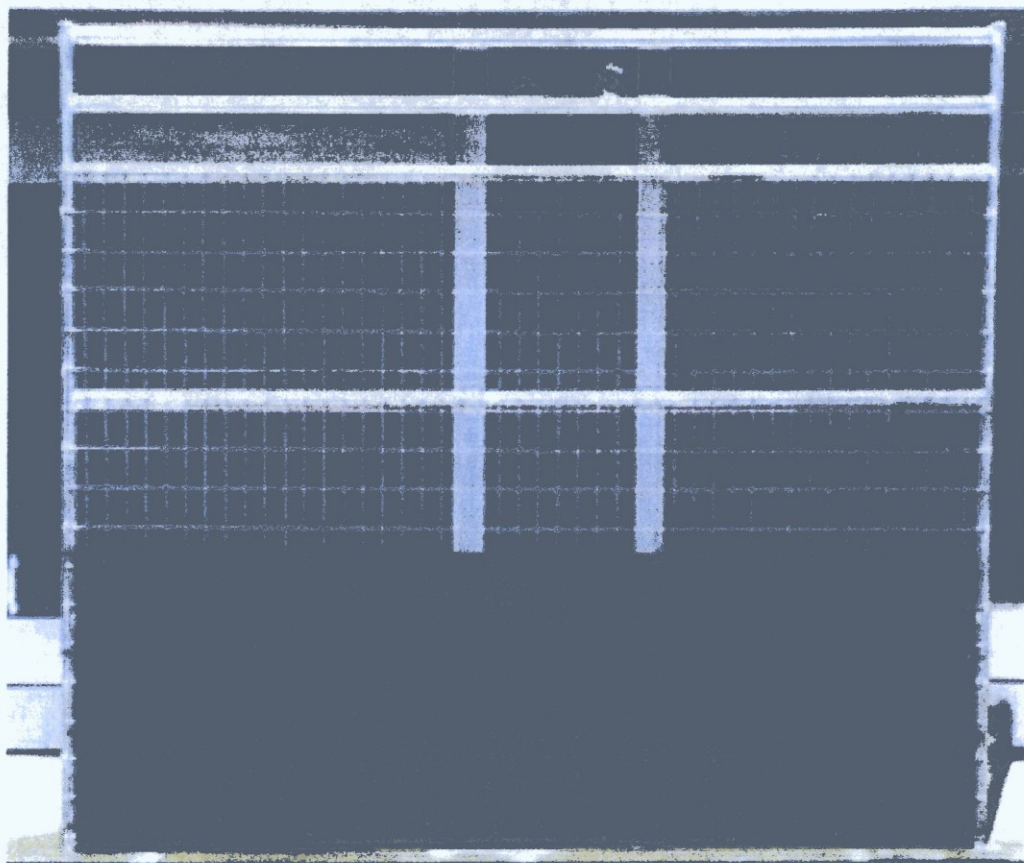

STANDARD ENCLOSURE PANEL WITH THE OPTIONAL FOOTING RETENTION SYSTEM. IT IS 2 FEET IN HEIGHT. PANEL IS 7' TALL AND 6' IN LENGTH.

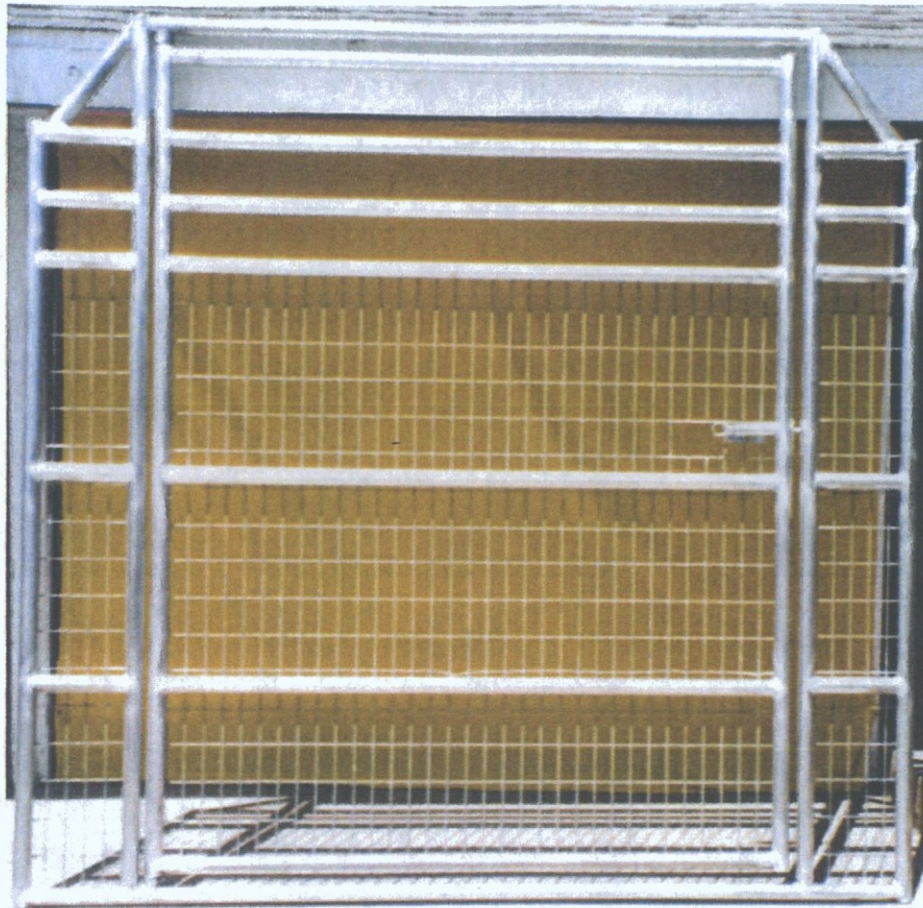

Main Entry/Exit Gate for Horses. 7 ft. Tall, 8 ft. Long. 1 7/8" pipe frame work, welded 360 degrees. Welded wire is 6 ft. tall, and welded to pipe framework. Gate opening is approximately 6 ft. wide by 8 ft. tall.

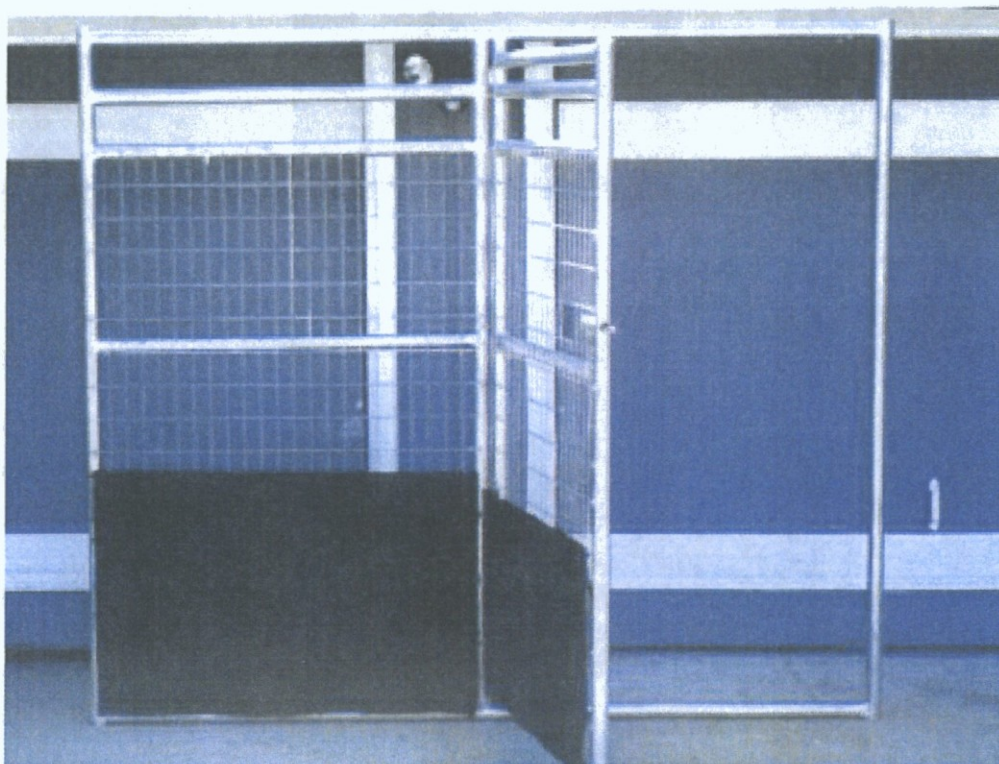

STANDARD GATE PANEL WITH THE OPTIONAL FOOTING RETENTION SYSTEM. IT IS 2 FEET IN HEIGHT. PANEL IS 7' TALL AND 6' IN LENGTH.



CENTAUR HORSE WALKERS, INC.

5761 RIDGEVIEW AVENUE
MIRA LOMA, CA 91752
(951) 685-7337 • FAX # (951) 685-0341
1-800-962-8050
www.hotwalkers.com

PRODUCT PAINT COLOR CHART

WEATHERED BROWN

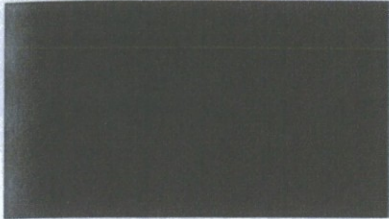

SPANISH TILE



POSTAL BLUE

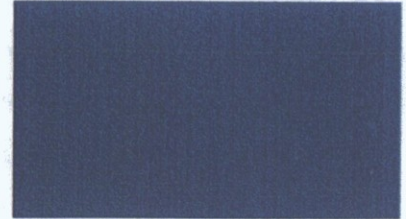

BOOM BROWN

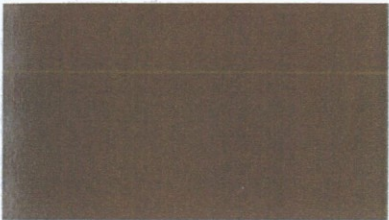

FIRE RED



PRECAUTION BLUE



SAN TAN

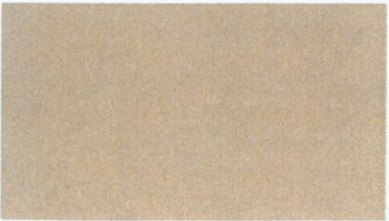

BLACK

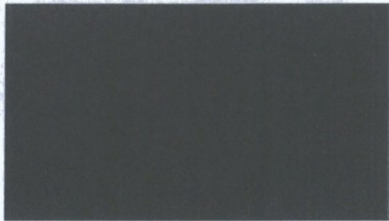

BRIDGEWATER



HI-LITE BUFF

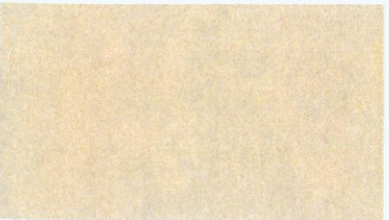

GUNMETAL GRAY

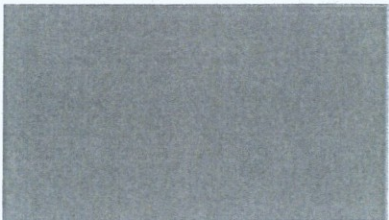

WOODLAWN GREEN

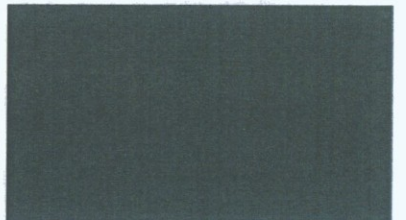

NAVAJO WHITE

WHITE



JOHN DEERE GREEN



COLOR SAMPLES ARE AFFECTED BY AGE, LIGHT AND MANUFACTURING METHODS. VARIATIONS IN SURFACE TEXTURE, LIGHTING AND APPLICATION MAY CAUSE THE PAINTED SURFACE TO VARY SLIGHTLY FROM THIS SAMPLE

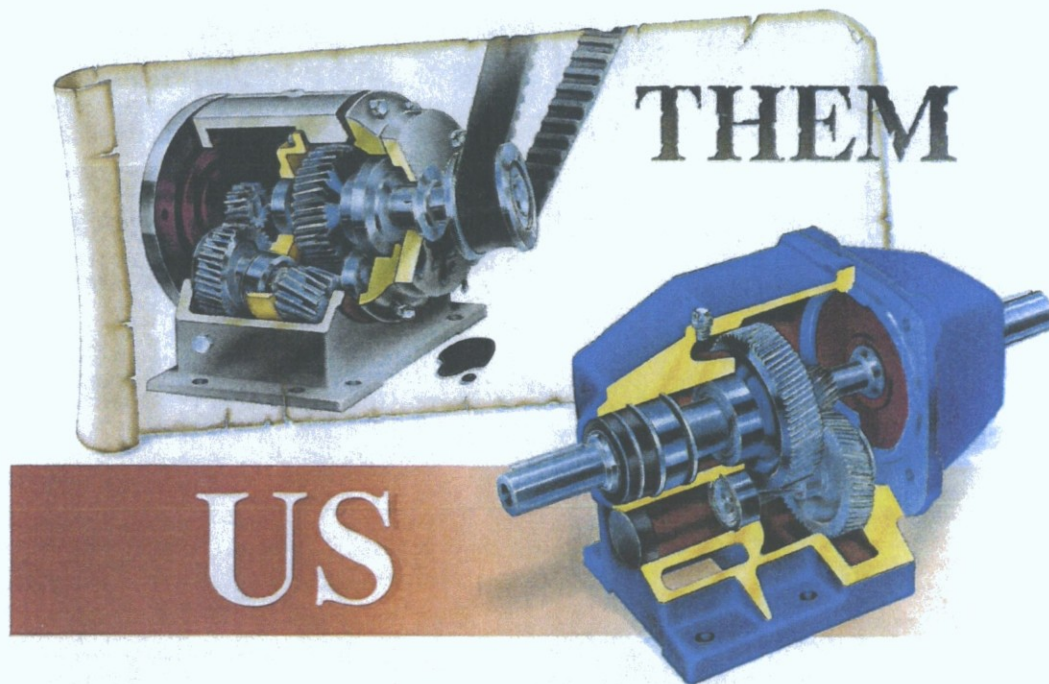

Say Goodbye to Yesterday's Design and Today's Headaches.

Conventional we're not. Because conventional doesn't always solve the problems you face. Take oil leakage in gearmotors and speed reducers. Who is the culprit? A major factor was bolt-on covers or flanges. Do you really need them? How about manufacturing the housing from a single casting? From a solid, robust piece of cast iron. At Nord

Gear, we call it the Unicase™ design. Thousands will tell you it works. Admirably.

Nord Gear also introduced the Quadrilip™ Sealing system. You'll find it on most of our units. This high quality set of seals keeps oil where it belongs - inside, and dirt outside. Nord also incorporated the auto vent breather plug to prevent

moisture from entering a reducer during washdown or when operating in humid outdoor conditions.

And if quietness means quality, you can't do better than Nord gears. Whatever your needs, no matter how special, talk to Nord Gear. We can offer you a vast array of high quality products extending to over 20 million variations.

UNICASE
EXCLUSIVELY FROM NORD GEAR



Nord Gear Corporation
P.O. Box 367/800 Nord Drive, Waunakee, WI 53597
(608) 849-7300 • Fax (800) 373-NORD
Charlotte, NC (704) 529-1255
Detroit, MI (248) 373-6673
Corona, CA (909) 279-2600

Nord Gear Limited
41 West Drive • Brampton, Ontario L6T 4A1
(905) 796-3606 • Fax (905) 796-8130
Montreal (514) 493-7694 • Fax (905) 352-6090
Toll Free Canada Phone (800) 665-4378

**24-HOUR
EMERGENCY RESPONSE**

USA (715) NORD-911
Canada (905) 792-7365

ISO9002

Also visit us on the Internet at: <http://www.nord.com>

PRODUCT

BULLETIN



UNICASE™ HIGH TORQUE HELICAL GEARMOTORS & SPEED REDUCERS

- FOOT OR FLANGE MOUNTING
- 275% MOMENTARY OVERLOAD CAPACITY

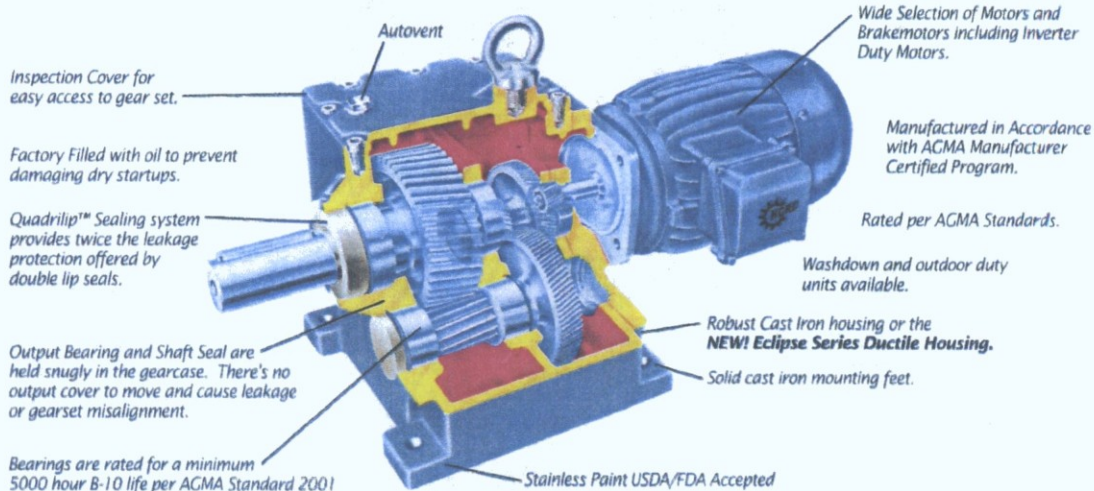

PERFORMANCE SPECIFICATIONS

- 1/4 to 200 hp
- Output torques to 177,000 lb. in.
- Output speeds from 0.1 to 384 rpm
- Gear ratios from 4.1:1 to 100,000:1
- 98% gear efficiency

EXCLUSIVE UNICASE™ CONSTRUCTION EXTENDS SERVICE LIFE

Gearcases are SAE 30 gray cast iron or Eclipse Series ductile cast iron with internal reinforcements for strength and rigidity. This design eliminates the oil leakage, oil contamination and gear set misalignment problems common to drives with bolt-on output covers or flanges.

INTEGRAL GEARMOTOR CONSTRUCTION FOR DEPENDABLE PERFORMANCE

When you choose a Nord integral gearmotor, you'll be assured of application-matched performance for years to come. With integral gearmotor construction, the possibility of an undersized or oversized motor being added to the gear unit is virtually eliminated.

FLEXIBLE MOUNTING

Nord helical gear drives are available for either foot or flange mounting. Strategically located oil-fill, drain and breather ports allow a wide range of mounting positions.

WIDE SELECTION OF SPEED REDUCERS

To meet your application needs, Nord helical speed reducers are available with: an input cover for belt, chain or direct coupled input, scoop motor mounting, platform motor mounting C-Face and IEC input flange motor mounting.

ADJUSTABLE-SPEED OPERATION

All Nord gearmotors are available with two styles of adjustable-speed drives. The Nordisc™ traction drive offers a 7:1 adjustable speed range for applications up to 7.5 hp. For adjustable speed applications up to 150 hp, Nord offers the Titan™ belt type drive with up to a 6:1 speed range.

ENGINEERING

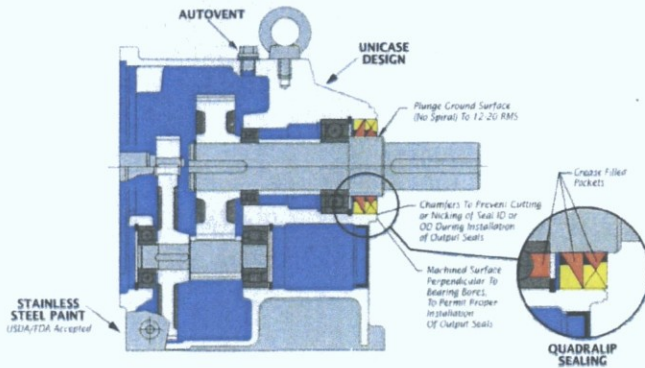

If you are a user of gearmotors, gear reducers, or mechanical power transmission equipment, you should be aware of Nord products and capabilities. Nord Gear products are based upon solid engineering design, minimizing problems often associated with gear drives such as gear noise and oil leakage.

You can expect the following advantages, in combination with high quality gearing:

- A high quality piece of equipment.
- A considerable reduction in the possibility of seal leakages.
- A unit with quiet gearing.
- Increased life of bearings and gears.
- High output torque capabilities.
- Elimination of leakages between output, input flanges and the actual gear housing.

Since leaks and noisy gears are directly related to a quality image, Nord Unicast can be considered top of the line.

UNICASE DESIGN

A robust one piece housing of the Unicast design and Nord's machining techniques assure virtually a "No Leak" situation. All bores & motor/input housing registers are machined in one set-up to assure accuracy and concentricity of the seal bores and bearing seats. The accurate concentric bores, without bolt-on covers, allow the seals/shafts to operate without pumping oil.

Nord supplies all reducers with an Autovent breather to prevent contamination or water from entering the reducer. Nord uses high quality Nitrile seals with garter springs which guarantee tight chocking around smooth, plunge ground shaft surfaces. Quality machining, attention to small details and careful assembly with proper tools guarantee long, trouble free operation.

QUADRILIP SEALING

Three seal lips and a grease filled chamber between the seals make up the sealing system. The grease chamber functions as an additional lip to protect the inner oil seal-lip from damage and external contamination. The grease also lubricates the seal lips, keeping them soft and flexible while reducing seal wear due to

reduced friction between the lip and shaft surfaces. The grease lubricates the seal surface and separates it from the shaft with a .0001" oil film barrier.

Oil seals function properly when installed perpendicular to the shaft and when they ride on a smooth plunge ground shaft surface finish of 12-20 RMS. In addition, the seal's OD/ID are concentric with the shaft and housing bore; therefore the seal will not pump oil, further ensuring "no leaks".

AUTOVENT

Gear reducers used in humid environments, washdown applications or dusty areas can be damaged by water or dust (in some cases, in combination with caustic or corrosive fluids) being sucked through the breather plug.

When water mixes with oil, the result is oil foaming, reduced lubricity, oxidation, and a rapid breakdown of oil and damage to bearings. A small amount of water (.04%) in oil can have dramatic effects. Dust is also damaging to bearings.

The Autovent allows us, to a great extent, to keep foreign material out of a reducer. The Autovent is basically a check-valve type of vent which is closed when the pressure differential between the inside and outside of the reducer is less than 2 psi.

The Autovent valve opens at 2 psi during operation due to the increase of the temperature and pressure in the reducer. The valve stays open until the pressure is reduced inside the reducer to the ambient level and then closes.

The valve components (ball and spring) are protected by a canopy. When the gearbox stops running and cools, the pressure inside drops and the valve stays tightly closed. The gearbox will then have a slight negative internal pressure. The seals are designed to prevent any material from entering during the entire "off/on" cycle.



Centaur Horse Walkers, Inc.

5761 Ridgeview Avenue

Mira Loma, Ca 91752

(951) 685-7337 • (951) 685-0341 Fax

1-800-962-8050

www.equinecisers.com

Dear Horse Owner,

First, I would like to thank you in advance, for allowing us to present our product line to you and submit our marketing information to you. I have enclosed our marketing package on our Free Flow Equinecisers for you to review, as per your request.

We can manufacture the system for you with or without our standard fencing. For a 50 ft. diameter 4-horse unit with fencing the price is \$22,575.00, a 50 ft. diameter 4-horse unit without fencing is \$15,200.00. These prices include, electrified divider screens. Diameters can be increased or decreased for each model, as per the clients needs.

Equineciser unit and arms will be powder coated one color of your choosing, from our color chart. The divider screens will be galvanized only, due to the fact that if they too are powder coated, they will not hold an electrical charge.

Centaur Horse Walkers, Inc. will supply all the necessary drawings & specifications for the installation of the concrete & electrical for your sub-contractors. We will also be happy to speak to your sub-contractors, and walk them through the concrete and/or electrical installations, over the telephone, fax and e-mail.

Terms:

50% Deposit to start your order (All major credit cards, personal checks, company checks, and cashier's checks, accepted) with the final 50% due prior to shipment (All major credit cards, or cashier's checks ONLY). Approximate production time is 14 working days from receipt of deposit.

I would like to point out a few things as you review the different proposals from the various Exerciser manufacturers.

- Centaur Horse Walkers, Inc. is a California based manufacturer.
- Centaur Horse Walkers, Inc. is a licensed California Corporation in Good Standing.
- Centaur Horse Walkers, Inc. uses the most advanced gearbox in the industry at this time. We use a German gearbox & motor manufactured by, Nord Gear Box.
- Centaur Horse Walkers, Inc. has a 5 Year Limited Warranty on the Drive System based on manufacturers inspection of unit.
- Centaur Horse Walkers, Inc. has a 1 Year Limited Warranty on the Controller based on manufacturers inspection of unit.
- Centaur Horse Walkers, Inc. offers 24-hour phone service, 7 days a week.



Centaur Horse Walkers, Inc.

5761 Ridgeview Avenue

Mira Loma, Ca 91752

(951) 685-7337 • (951) 685-0341 Fax

1-800-962-8050

www.equinecisers.com

- Our local manufacturers keep all of the component parts used in our Equinecisers, in stock.
- All of our suppliers are within a 10-mile radius of our manufacturing facility.
- Centaur Horse Walkers, Inc. does not use a chain driven drive, which can burn up motors due to torque.

We have over 45 years expertise in manufacturing Equine Products, and have been manufacturing the Free Flow Equinecisers for the last 16 years.

We can either make for you, just the Equineciser System itself without any fencing, so that you can do your own fencing, or we can manufacture our standard welded wire fencing with the Equineciser System. We can also manufacture custom fencing for you if you so desire, call our office, and let us know what you would like so that we may research the costs & provide you with a quote on customized fence panels.

If you so desire, we can do the installation for you as well, we can either do a total turnkey where we do the concrete, electrical & fencing installation, or if you prefer, you can do this yourself. Please contact our office and request more information, so that we can provide you with a customized proposal for the work you would like Centaur Horse Walkers, Inc. to do.

We offer to all of our Free Flow Equineciser clients at NO charge to you, unlimited phone, fax and email consultations with our Field Project Coordinator to advise you, or your contractors on site preparation for the Free Flow Equineciser.

We also offer to all our Free Flow Equineciser clients, the option to have a field project coordinator come to your Ranch for 2 days, to oversee your workers, & contractors, to make sure the pad is LEVEL, the electrical is wired correctly, & the cement is correct, and the fencing is installed correctly. There is a labor charge for this, and we must also charge the following costs: airfare (if applicable), vehicle rental, and lodging. We will provide receipts to you the client, and you just pay the costs, we do not charge any extra.

If you purchase just the Equineciser Unit itself, it takes us roughly 7 days to manufacture, shipping depending on your location can take up to 2 weeks to get to you. If you purchase our Standard fencing with the Equineciser Unit, it takes us roughly 2 weeks to manufacture everything, and then again depending on your location it can take up to 2 weeks for shipment. If you order customized fencing, a manufacturing time will be quoted to you with the price.

PLEASE NOTE: That we ship our equinecisers by LTL loads, to obtain the cheapest freight rate. These equinecisers do not take up the entire flat bed, thus the trucking company will hold the load until it has filled the entire trailer. The actual driving time can be up to 2 weeks, depending on our location. Should you want your equineciser shipped directly to you, without waiting for the trucking company to fill the entire trailer, we can give a quote as well, but keep in mind that the freight charges will be extremely high.



Centaur Horse Walkers, Inc.

5761 Ridgeview Avenue

Mira Loma, Ca 91752

(951) 685-7337 • (951) 685-0341 Fax

1-800-962-8050

www.equinecisers.com

Please NOTE: These are very large, heavy machines, and they do require you to have an all terrain forklift with fork extensions at your facility at the time of delivery to remove them from the truck. We ask that you have the forklift on your property at the time of delivery, as not to delay the truck driver. The trucking company and/or the truck driver will call you at least 24 hours prior to reaching your Ranch, once you have received a call from him, then you need to rent a forklift & have it at your Ranch.

For your convenience, we accept all major credit cards.

Thank you for taking the time out of your schedule to review our marketing information, we hope this information answers most of your questions about our Equinecisers, and Centaur Horse Walkers, Inc.

If you decide to go with another manufacturer, I wish to thank you again for allowing us to present our Free Flow Equinecisers to you.

We have enclosed a brochure, photos & specifications for you to review, should you have any further questions, comments or concerns, feel free to contact us, we are here to assist you!

Respectfully,

Alan Cobham
Centaur Horse Walkers, Inc.



Centaur Horse Walkers, Inc.

5761 Ridgeview Avenue

Mira Loma, Ca 91752

(951) 685-7337 • (951) 685-0341 Fax

1-800-962-8050

www.equinecisers.com

The Horse Exerciser

The horse exerciser offers an advantage over earlier versions of this type of device, the hot walking machine. The older style of hot walker required the horse to be tied to an arm of the walker. If a horse pulled back or balked on one of these walkers, he could receive a neck injury. The machines were designed to go at one speed only, for the walk, so they were not suitable for sport conditioning.

The new horse exerciser allows the horse to exercise unthethered between moving gates, so he can move in a more natural manner, with his head free. A carousel rotates the six gates that provide individual compartments for six horses to exercise unthethered. There is a distance of 34 feet between each gate, so the horse has plenty of room. When allowed to manage his own speed, a horse will go a little slower at times and a little faster at times. The exerciser allows for this natural regulation of energy expenditure, resulting in a more comfortable exercise session.

The Centaur Horse Equineciser can go from 0 to 20 miles per hour, allowing the horse to exercise at all speeds, including the walk, trot, jog, and gallop in both directions. The cost of the horse exerciser starts at \$13,500.00. The horse moves between outer and inner fences that are set in concentric circles. The outside fence forms a circle with a diameter based on model of exerciser. As the horse travels the circle, the footing banks against the outside fence. The faster he goes, the more the surface banks, so limb loading remains even. This is the contrast to lunging in the arena, where the surface is flat, the circle is small, and considerable-torquing force is placed on the limbs. The centrifugal forces are more like those on a racetrack and help the racehorse adapt to that strain. The Exerciser offers an advantage over the high-speed treadmill in that it provides the opportunity to train around a curve, rather than continuously going in a straight line. This might help in the adaptation of the cannon bones to the compressive forces of running around the turn on a track-like-surface in a way that is impossible to achieve on a treadmill.

Horse exercisers can be built with or without a roof, but the roof provides protection from bad weather. Whether the exerciser has a roof or not, the surface is a primary concern so that footing remains good and injuries from bad footing are avoided.

A variety of surfaces have been tried, and some have proven better than others have. Sand will compact and become too hard. Sand also freezes and does not break up easily. Frozen footprints in the sand create a choppy surface. Wood chips placed on top of sand do not create a satisfactory surface. Shredded rubber provides a resilient surface, but is unsatisfactory when placed over sand. These observances are based on geographical location, and whether or not your exerciser is outside exposed to the elements, or inside a building.

Using the Horse Exerciser

Planning your use of the horse exerciser will follow the same guidelines that you would use for any new equipment or training technique. The first time your horse goes in the exerciser the goal is to acclimate him to the equipment. Walk the horse until he is comfortable, usually 15 to 20 minutes. 95% of horses take to the exerciser



Centaur Horse Walkers, Inc.

5761 Ridgeview Avenue

Mira Loma, Ca 91752

(951) 685-7337 • (951) 685-0341 Fax

1-800-962-8050

www.equinecisers.com

with no problem during the first session. The technique is to put the horse in, release him, and then turn on the exerciser at a brisk or extended walking speed. -On the first day of using the exerciser with your horse, do not walk him until he is tired.

The goal of the first few sessions is simply to give him an opportunity to be comfortable in the exerciser. Horsemanship is still needed to use this equipment to the benefit of the horse. Observation and attention to task are necessary just as these skills are in any other training program.

Once the horse has become accustomed to walking in the exerciser, plan a gradually increasing program that is based on the fitness goals for each individual horse. Is your goal to maintain the fitness level reached during the summer? Is it to rehabilitate from an injury during the competitive off-season? Is it to increase the horse's knowledge of new tasks and environments? Plan your training bouts to increase in duration and intensity gradually. Do not try to accomplish all your fitness goals at once. NEVER leave horses alone in the exerciser unsupervised.

Using What's at Hand

You don't have an indoor exercise facility, you say? You still should be concerned about the surface on which you train when weather leaves footing unsafe, choppy or frozen. If a training path around your paddock is the route you follow, the minimum investment would be to improve the drainage by grading it to a one degree slope under a surface such as those mentioned above- one that will break up easily when the temperature is below freezing. Do not turn horses loose in the training paddock as they will dig holes in your surface and destroy it.

A Safe surface is essential for any training program in the winter so the horse will not lose muscle and cardiovascular conditioning. Injuries to both horse and rider can occur on a slick surface. A surface that is frozen and will not break up promotes sore feet and injuries to joints.

Training for any equine sport requires rapid changes of direction, increases in speed, or negotiating jumps and concussion of the foot on the ground. A surface that provides adequate traction and cushion for your particular equine sport is the ideal surface.

REPLACES THE OLD STYLE HOT WALKING MACHINES OR THE NEED FOR HAND WALKING

Keeping your stallions in shape for breeding season. Excellent for conditioning horses for sales, from weanlings on up. Conditioning two year olds prior to sending them into training. Exercising broodmares for their health as well as the health of their unborn foals. The **EQUINECISER** can also be used for warming horses up prior to exercise and cooling down after exercise. Horses can be placed into the **EQUINECISER** wearing complete Bitting Rigs to aid in their development.



Centaur Horse Walkers, Inc.

5761 Ridgeview Avenue

Mira Loma, Ca 91752

(951) 685-7337 • (951) 685-0341 Fax

1-800-962-8050

www.equinecisers.com

The **FREE FLOW™ EQUINECISER** comes with a variable speed, reversible drive control that will allow the **EQUINECISER** to go from a slow walk up to a slow gallop and enables the exercising of 3, 4, 5, 6, 7, or 8 at one time. The horses exercise untethered between moving gates spanning thirty-four feet, on a 6 horse exerciser. These hinged gates move in between two round fences that are nearly eight feet apart.

CENTAUR FREE FLOW™ MULTIPLE HORSE EQUINECISER

QUALITY FEATURES

FREE FLOW 300FF, 400FF, 500 FF, 600FF Equineciser Models

- ◆ Direct Power Drive System
- ◆ Single Phase 220 Volt Power System
- ◆ 3 HP Motor.
- ◆ Totally enclosed steel cover on all drive components
- ◆ Wall Mounted Remote Control Box designed for rugged usage
- ◆ Speeds 0 MPH to 20 MPH, Forward and Reverse
- ◆ Powder Coated Base and Arms Only

SAFE

- ◆ Solid Construction
- ◆ Quality Material
- ◆ Emergency Stopping Feature

ECONOMICAL

- ◆ Efficient Time Management
- ◆ Labor Saving
- ◆ Minimum Maintenance
- ◆ User Friendly Controls



Centaur Horse Walkers, Inc.

5761 Ridgeview Avenue

Mira Loma, Ca 91752

(951) 685-7337 • (951) 685-0341 Fax

1-800-962-8050

www.equinecisers.com

PERFORMANCE

- ◆ Adjustable from a walk to a canter, based on model and diameter.
- ◆ Variable Training & Exercising programs.
- ◆ Increased development of muscular and skeletal systems.
- ◆ Improved Cardiovascular performance.



Centaur Horse Walkers, Inc.

5761 Ridgeview Avenue

Mira Loma, Ca 91752

(951) 685-7337 • (951) 685-0341 Fax

1-800-962-8050

www.equinecisers.com

CENTAUR FREE FLOW™ MULTIPLE HORSE EQUINECISER TECHNICAL INFORMATION

- Models:** 300FF (3 Horse), 400FF (4 Horse), 500FF (5 Horse), 600FF (6 Horse), 700FF (7 horse), 800FF (8 horse)
- Working Diameter:** 40 to 80ft depending on choice of model. Customized Diameters available.
- Speeds:** Remote Controlled 0 MPH to 20 MPH, Forward and Reverse.
- Arms & Mast:** Square Structural, seamless tubing. Arm Height is 8 ft from the ground. Arm Radius is 20 to 34 ft depending on choice of model. Working width for horse is 8'. Length distance is 32 ft, minimum, between individual moving screens, based on model & diameter.
- Power Drive System:** The Equineciser is a direct drive electrical motor to a speed reduction gearbox. The motors are 3 HP. All motors are hi-torque, heavy duty, thermally protected with auto reset. The unit requires a power input of 220-volt single phase. Your breaker panel must have the following: 2 – 20 amp double pull (for the 220V input) & 1 – 20 amp single pull for your Equineciser to work correctly.
- Remote Controller:** All of the Equinecisers come with a remote control with a directional control switch, for forward & reverse and an emergency safety stop switch.
- Enclosure Panels:** Standard is 7 ft tall, and 6 ft long outside panels, inside panels are 7 ft. tall and 6 ft. long. Galvanized welded wire, which is welded to panel frame, and is 6 ft in height, and spring-loaded latches on each gate panel. The framework is 1 7/8" round galvanized steel pipe. Gate panels have a 6 ft. opening.
- Finish on Fence:** The standard steel framework of the fence panels comes galvanized. The framework is of round tubing, with welded wire attached, on the lower 6 feet.
- Options Include:** A timer, programmable up to an hour. Radius Fencing galvanized or painted. Roofing Systems – Cantilevered over exercise path, circular roof to cover entire equineciser and exercise path, or rectangular roof. All have a 10 ft. eave height on the outside fence. Call for roof quotes, based on geographical location.
- Panel Options:** Lower 4' X 8' section solid steel, or steel & wood laminated, or wood (tongue & groove), or extruded white or tan PVC 2" X 6" panels inserted into steel framework, or T1-11 & steel laminated. All panels can be lined with rubber matting on the lower 2 ½ feet, to aid in soil retention. Standard wood fencing is also available.



Centaur Horse Walkers, Inc.

5761 Ridgeview Avenue
Mira Loma, Ca 91752
(951) 685-7337 • (951) 685-0341 Fax
1-800-962-8050
www.equinecisers.com

INSTALLATION:

Electrical controls **MUST BE** installed by a licensed electrician to warranty the product. A copy of electricians invoice, and electrical license must accompany all claims.

All Free Flow Products come with an easy to read, easy to use, installation manual, so that you may install it yourself, or hire someone else to do the installation for you.

If you prefer, Centaur can send down a consultant to oversee the installation by your workers or contractor, call Centaur for a quote.

Installation quotes based on: Consulting fee, Transportation of consultant to your facility (including airfare, & car rental), lodging and food for consultant. Length of installation depends on Model Selected, site preparation and number of workers doing the installation.

Centaur Free Flow Equineciser Limited Warranty

Centaur Twelve-Year Limited Warranty

Centaur Horse Walkers, Inc warrants that for a period of twelve (12) years after the date of delivery it will re-supply the following component parts: structural steel components of Equineciser only, (for fencing see below) (under normal usage) on their Free Flow Equinecisers Models 300FF, 400FF, 500FF, 600FF, 700FF and 800FF to the original user against defects in workmanship or materials under normal use, with regular service maintenance of the equineciser sold that prove to be defective in respect to the materials and/or workmanship. The warranty is expressly limited to furnishing (but not dismantling or installing) necessary replacement parts, does not cover or include any consequential damages and does not cover defects or damage caused by acts of God, falling objects, or other accidents or casualties, aggressive atmosphere conditions (including, but not limited to, salt water atmosphere, fallout or exposure to corrosive chemicals, fumes, ash, animal waste, excessive wind and excessive snow loading or the like), improper installation, neglect, negligence abuse or willful damage by Purchaser, this includes attaching objects to the screens and/or the arms, to use to level and/or smooth out the exerciser path, & attaching objects to the screens and/or arms, to use as a weather shade. Any defect or damage covered by this warranty must be reported to Centaur, in writing within 30 days after discovery or this warranty shall be void. It is expressly understood and agreed that any warranty, expressed or implied, shall extend only to structural defects in the material, whether galvanized (optional) or steel (standard), and any component parts appurtenant to the equipment. Any part, which is determined by Centaur to be defective in material or workmanship and returned to our authorized service location, as Centaur designates, shipping costs prepaid by client, will be, as the exclusive remedy, repaired or replaced at Centaur's option. Shipping to be supplied by client on all returning items. For limited warranty, claim procedures see PROMPT DISPOSITION below. This limited warranty gives purchasers specific legal rights, which vary, from state to state. THIS WARRANTY IS GIVEN EXPRESSLY AND IN PLACE OF ALL OTHER EXPRESS OR IMPLIED WARRANTIES INCLUDING IMPLIED WARRANTIES OF MERCHANTABILITY AND FITNESS FOR A PARTICULAR PURPOSE.



Centaur Horse Walkers, Inc.

5761 Ridgeview Avenue

Mira Loma, Ca 91752

(951) 685-7337 • (951) 685-0341 Fax

1-800-962-8050

www.equinecisers.com

Centaur Five-Year Limited Warranty

Centaur Horse Walkers, Inc warrants that for a period of five (5) years after the date of delivery it will re-supply the following component parts: Falk Collar Coupling, and the Drive System (Gearbox, and Motor) (under normal usage) on their Free Flow Equinecisers Models 300FF, 400FF, 500FF, 600FF, 700FF and 800FF to the original user against defects in workmanship or materials under normal use, with regular service maintenance of the equineciser sold that prove to be defective in respect to the materials and/or workmanship. The warranty is expressly limited to furnishing (but not dismantling or installing) necessary replacement parts, does not cover or include any consequential damages and does not cover defects or damage caused by acts of God, falling objects, or other accidents or casualties, aggressive atmosphere conditions (including, but not limited to, salt water atmosphere, fallout or exposure to corrosive chemicals, fumes, ash, animal waste, excessive wind and excessive snow loading or the like), improper installation, neglect, negligence abuse or willful damage by Purchaser, this includes attaching objects to the screens and/or the arms, to use to level and/or smooth out the exerciser path, & attaching objects to the screens and/or arms, to use as a weather shade. Any defect or damage covered by this warranty must be reported to Centaur, in writing within 30 days after discovery or this warranty shall be void. It is expressly understood and agreed that any warranty, expressed or implied, shall extend only to structural defects in the material, whether galvanized (optional) or steel (standard), and any component parts appurtenant to the equipment. Any part, which is determined by Centaur to be defective in material or workmanship and returned to our authorized service location, as Centaur designates, shipping costs prepaid by client, will be, as the exclusive remedy, repaired or replaced at Centaur's option. Shipping to be supplied by client on all returning items. For limited warranty, claim procedures see PROMPT DISPOSITION below. This limited warranty gives purchasers specific legal rights, which vary, from state to state. THIS WARRANTY IS GIVEN EXPRESSLY AND IN PLACE OF ALL OTHER EXPRESS OR IMPLIED WARRANTIES INCLUDING IMPLIED WARRANTIES OF MERCHANTABILITY AND FITNESS FOR A PARTICULAR PURPOSE.

Centaur Two-Year Limited Warranty

Centaur Horse Walkers, Inc warrants that for a period of two (2) years after the date of delivery it will re-supply the following component parts: Control Box, (under normal usage) on their Free Flow Equinecisers Models 300 FF, 400 FF, 500 FF, 600 FF, 700 FF and 800 FF to the original user against defects in workmanship or materials under normal use, with regular service maintenance of the equineciser sold that prove to be defective in respect to the materials and/or workmanship. The warranty is expressly limited to furnishing (but not dismantling or installing) necessary replacement parts, does not cover or include any consequential damages and does not cover defects or damage caused by acts of God, falling objects, or other accidents or casualties, aggressive atmosphere conditions (including, but not limited to, salt water atmosphere, fallout or exposure to corrosive chemicals, fumes, ash, animal waste, excessive wind and excessive snow loading or the like), improper installation, neglect, negligence abuse or willful damage by Purchaser, this includes attaching objects to the screens and/or the arms, to use to level and/or smooth out the exerciser path, & attaching objects to the screens and/or arms, to use as a weather shade. Any defect or damage covered by this warranty must be reported to Centaur, in writing within 30 days after discovery or this warranty shall be void. It is expressly understood and agreed that any warranty, expressed or implied, shall extend only to structural defects in the material, whether galvanized (optional) or steel



Centaur Horse Walkers, Inc.

5761 Ridgeview Avenue

Mira Loma, Ca 91752

(951) 685-7337 • (951) 685-0341 Fax

1-800-962-8050

www.equinecisers.com

(standard), and any component parts appurtenant to the equipment. Any part, which is determined by Centaur to be defective in material or workmanship and returned to our authorized service location, as Centaur designates, shipping costs prepaid by client, will be, as the exclusive remedy, repaired or replaced at Centaur's option. Shipping to be supplied by client on all returning items. For limited warranty, claim procedures see PROMPT DISPOSITION below. This limited warranty gives purchasers specific legal rights, which vary, from state to state. **THIS WARRANTY IS GIVEN EXPRESSLY AND IN PLACE OF ALL OTHER EXPRESS OR IMPLIED WARRANTIES INCLUDING IMPLIED WARRANTIES OF MERCHANTABILITY AND FITNESS FOR A PARTICULAR PURPOSE.**

Centaur One-Year Limited Warranty

Centaur Horse Walkers, Inc warrants that for a period of one (1) year after the date of delivery it will re-supply the following component parts: AC Tech Controller, Power Flex Controller, and/or ABB Controller, Fence Shocker, and Fencing (under normal usage) on their Free Flow Equinecisers Models 300 FF, 400 FF, 500 FF, 600 FF, 700FF and 800 FF to the original user against defects in workmanship or materials under normal use, with regular service maintenance of the equineciser sold that prove to be defective in respect to the materials and/or workmanship. The warranty is expressly limited to furnishing (but not dismantling or installing) necessary replacement parts, does not cover or include any consequential damages and does not cover defects or damage caused by acts of God, falling objects, or other accidents or casualties, aggressive atmosphere conditions (including, but not limited to, salt water atmosphere, fallout or exposure to corrosive chemicals, fumes, ash, animal waste, excessive wind and excessive snow loading or the like), improper installation, neglect, negligence abuse or willful damage by Purchaser, this includes attaching objects to the screens and/or the arms, to use to level and/or smooth out the exerciser path, & attaching objects to the screens and/or arms, to use as a weather shade. Any defect or damage covered by this warranty must be reported to Centaur, in writing within 30 days after discovery or this warranty shall be void. It is expressly understood and agreed that any warranty, expressed or implied, shall extend only to structural defects in the material, whether galvanized (optional) or steel (standard), and any component parts appurtenant to the equipment. Any part, which is determined by Centaur to be defective in material or workmanship and returned to our authorized service location, as Centaur designates, shipping costs prepaid by client, will be, as the exclusive remedy, repaired or replaced at Centaur's option. Shipping to be supplied by client on all returning items. For limited warranty, claim procedures see PROMPT DISPOSITION below. This limited warranty gives purchasers specific legal rights, which vary, from state to state. **THIS WARRANTY IS GIVEN EXPRESSLY AND IN PLACE OF ALL OTHER EXPRESS OR IMPLIED WARRANTIES INCLUDING IMPLIED WARRANTIES OF MERCHANTABILITY AND FITNESS FOR A PARTICULAR PURPOSE.**

Mats on the bottom of screens or attached to fence panels do NOT come with a warranty. Any part, which is determined by Centaur to be defective in material or workmanship and returned to our authorized service location, as Centaur designates, shipping costs prepaid by client, will be, as the exclusive remedy, repaired or replaced at Centaur's option. Shipping to be supplied by client on all returning items. For limited warranty claim procedures see PROMPT DISPOSITION below. This limited warranty gives purchasers specific legal rights, which vary, from state to state.



Centaur Horse Walkers, Inc.

5761 Ridgeview Avenue

Mira Loma, Ca 91752

(951) 685-7337 • (951) 685-0341 Fax

1-800-962-8050

www.equinecisers.com

Any dispute about quality, condition or workmanship of the goods or otherwise in connection with the terms of this Agreement, shall not entitle the Buyer to reject the goods. In the case of any dispute the Buyer shall take delivery of the goods, pay for the same, and make a claim under the **Centaur's** warranty.

Working Diameter is approximate intended to identify size sold by **Centaur**. Centaur gives no warranty or representation as to exact dimensions of the working diameter, as the same will vary depending upon placement of concrete base.

Limitation of Liability

To the extent allowable under applicable law, **Centaur's** liability for consequential and incidental damages is expressly disclaimed. **Centaur's** liability in all events is limited to, and shall not exceed, the purchase price paid.

Warranty Disclaimer

Centaur has made a diligent effort to illustrate and describe the products in this literature accurately; however such illustrations and description are for the sole purpose of identification, and do not express or imply a warranty that the products are merchantable, or fit for a particular purpose, or that the products will necessarily conform to the illustrations or descriptions.

Product Suitability

Many states and localities have codes and regulations governing sales, construction installation and/or use of products for certain purposes, which may vary from those in neighboring areas. While **Centaur** attempts to assure that its products comply with such codes it cannot guarantee compliance and cannot be responsible for how the product is installed or used. Before purchase and use of our products, please review the product application, and national & local codes and regulations, and be sure that the product, installation, and use will comply with them.

Certain aspects of disclaimers are not applicable to consumer products; e.g., (A) some states do not allow the exclusion or limitation of incidental or consequential damages, so the above limitations or warranty lasts, consequently the limitations may not apply to you; (B) Also, some states do not allow limitations on how long an implied warranty lasts, consequently the above limitations may not apply to you; and (C) by law, during the period of the limited warranty any implied warranties of merchantability or fitness for a particular purpose applicable to consumer products purchased by consumer, may not be excluded or otherwise disclaimed.



Centaur Horse Walkers, Inc.

5761 Ridgeview Avenue

Mira Loma, Ca 91752

(951) 685-7337 • (951) 685-0341 Fax

1-800-962-8050

www.equinecisers.com

Prompt Disposition

Centaur will in good faith effort for prompt correction or other adjustment with respect to any product, which proves to be defective within limited warranty. For any product believed to be defective within limited warranty, first write or call dealer from whom product was purchased. Dealer will be given additional directions. If unable to resolve satisfactorily write to **Centaur Horse Walkers, Inc.**, 5761 Ridgeview Ave., Mira Loma, Ca. 91752, giving dealer's name, address, date and number of dealer's invoice, and describing the nature of the defect. Title and risk of loss pass to buyer on delivery to common carrier. If product was damaged in transit you, file claim with freight carrier.

20 Reasons to Lease

1. **100% Financing:** Traditional methods of financing usually do not include "soft" items such as installation and freight. A lease transaction can contain both of these, thereby allowing you to finance the entire package.
2. **No Down Payment:** Most traditional financing options require a sizable down payment. On cash purchases this can be as much as 20%. Now down payment is required on a lease.
3. **Use of Equipment:** Leasing is the use of an asset. Leasing enables you to pay as you use.
4. **Fixed Payments:** In times when many financing transactions have floating interest rates, knowing in advance what your payments will be enables you to budget and manage equipment dollars.
5. **Longer Terms:** Many banks only lend money short term, usually 12 to 36 months. In lease arrangements, the term can be as long as 60 months or even longer.
6. **Protection from Obsolescence:** Industry analysts say today's equipment can be technologically obsolete much quicker than before, due to developmental advances. This is especially true with computers.
7. **Flexibility:** Leasing provides the lessee with greater structuring flexibility and the opportunity to make the most of such lease structuring variables as number and amount of advance payments, purchase options, etc.
8. **Simpler Than Bank Loans:** Leasing programs and procedures are specially designed to take the red tape out of financing capital equipment for business.
9. **Purchase or Renewal Options:** Most lease arrangements allow customers the option to either purchase at a state amount or at Fair Market Value, or to renew the lease at a reduced monthly payment.



Centaur Horse Walkers, Inc.

5761 Ridgeview Avenue
Mira Loma, Ca 91752
(951) 685-7337 • (951) 685-0341 Fax
1-800-962-8050
www.equinecisers.com

10. **Conversation of Capital:** Many businesses lease to conserve capital. Leasing always wins out in the "lease versus buy" analysis.
11. **Easier Cash Flow Forecasting:** Leasing, which is simply dollars-per-month financing, helps an equipment user fit a monthly payment into their budget because payments are fixed.
12. **Ability to Work Within Budget:** Many businesses lease because it allows them to have the use of the equipment (which is all they really want) and still work within operating budget limits.
13. **Tax Benefits:** Businesses can usually deduct their monthly lease payment as an operating expense. This clearly reduces the net cost of the lease.
14. **Special Programs:** Marketing and pricing programs can be customized to reflect the financing needs of specific industries.
15. **Master Lease:** Businesses with multiple locations or divisions can derive benefits from a Master Lease Agreement (MLA), a master agreement between the lessee and lessor as to the terms and conditions under which they will do business.
16. **State-of-the-Art Equipment:** When dollars are already budgeted, managers who need newer equipment can conveniently acquire that equipment on a dollars-per-month basis.
17. **Additional Lines of Credit:** When equipment is bought with borrowed funds, credit lines with a lender are reduced. When equipment is leased, a business has, in fact established an additional line of credit with its lessor.
18. **Its Quick and Easy - - You can even do it Online:** By completing one simple application, you can have an answer in just hours.
19. **Use Lessor for Other Equipment Needs:** While some companies have captive finance companies to handle only their equipment, other lessor are in the position to lease just about anything from photocopies to forklifts.
20. **Create Profits:** Leasing your new machinery and equipment will allow you to preserve your existing cash flow to respond to new business opportunities. The profit generated from the productivity of the equipment is usually greater than the lease payments.



Centaur Horse Walkers, Inc.

5761 Ridgeview Avenue
Mira Loma, Ca 91752
(951) 685-7337 • (951) 685-0341 Fax
1-800-962-8050
www.equinecisers.com

If leasing is desired, we offer leasing through:

J&L Capital Resources
Rob Driver
PO Box 368
Cell# 559-779-2558
Fax# 559-251-1028
Toll free# 800-767-0001
robdriver@yahoo.com

Innovative Lease Services, Inc.
5931 Priestly Drive Suite 102
Carlsbad, CA 92008
800-438-1470
innovative@ilslease.com

We have heard from our clients that these companies offer better customer service, and better rates, than traditional financing through bank loans.
Please fill out the attached application & return it to the leasing company of your choice.



Centaur Horse Walkers, Inc.

5761 Ridgeview Avenue
 Mira Loma, Ca 91752
 (951) 685-7337 • (951) 685-0341 Fax
 1-800-962-8050
 www.equinecisers.com

Business Information

Lease Application

Legal Business Name				Date Established	Date Incorporated
Legal Business Address			City	State	Zip
How Long at this Address					
Location of Equipment (If Other than Business Address)			Phone Number		Fax Number
Line of Business		Previous Bus. Affiliation (If in Business Less than 2 Years)			How Long
Name of Landlord Company			Contact		Phone Number

Ownership / Guarantor Information

Type of Business (Proprietorship, Partnership, Corporation)				Federal Tax Number / Business License Number	
Name		% Ownership	Title	Social Security Number	
Home Address		City	State	Zip	Home Phone
					Home Fax
Name		% Ownership	Title	Social Security Number	
Home Address		City	State	Zip	Home Phone
					Home Fax

Insurance Information

Name of Business Insurance Company		Contact	Phone Number
------------------------------------	--	---------	--------------

Trade References / Suppliers

Name of Company		Contact	Phone Number

Bank References

Name of Bank	Contact	Phone Number	Account Number	Bus/Pers

Vendor & Equipment Lease Information

Vendors Company Name & Address			Contact	Phone Number
Centaur Horse Walkers, Inc. 5761 Ridgeview Ave. Mira Loma, Ca 91752			Alan Cobham	1-800-962-8050
Term	Amount to be Financed	Description of Equipment		New/Used (Year)

THE UNDERSIGNED HEREBY GRANTS PERMISSION TO THE ABOVE COMPANY AND/OR ITS ASSIGNS TO OBTAIN INFORMATION FROM ANY SOURCE INFORMATION RELATED TO ITS CREDIT STANDING, AGREES TO SUPPLY SUCH FINANCIAL STATEMENT(S) AND ANY OTHER INFORMATION VIA FAX OR OTHERWISE AS MAY BE REASONABLY REQUESTED AND WARRANTS THE ACCURACY OF THE INFORMATION IN THIS APPLICATION AND ANY OTHER MATERIAL SUBMITTED BY THE UNDERSIGNED. THE UNDERSIGNED HEREBY GRANTS PERMISSION TO THE ABOVE COMPANY AND/OR ITS ASSIGNS TO SUBMIT THE INFORMATION RECEIVED FROM THE UNDERSIGNED TO CERTAIN FINANCIAL INSTITUTIONS THAT MAY HAVE AN INTEREST IN FUNDING THIS TRANSACTION. PLEASE BE ASSURED THAT ALL INFORMATION WILL BE HELD IN THE STRICTEST CONFIDENCE.



Centaur Horse Walkers, Inc.

5761 Ridgeview Avenue

Mira Loma, Ca 91752

(951) 685-7337 • (951) 685-0341 Fax

1-800-962-8050

www.equinecisers.com

Free Flow Equineciser Installation Options Available

~NOTE: The following prices on packages a, b, c, & d are for labor only, they do not include, airfare, car rental, lodging, meals, fuel, & drive time. Client will be given a quote for airfare, car rental, lodging, meals, fuel, & drive time, once we are given an address.

PACKAGE A:

\$2,500.00

Includes the following:

Install a 6' X 6' Concrete Slab (Material & Labor)

Electrical Installation in NORMAL Soil, from Equineciser to Control Box on exterior perimeter fence. 3 Conduits,

1 Conduit to contain - Low Voltage wire & 110 Volt wire for screen shocker.

1 Conduit to contain - 220 Volt wire to controller

1 Conduit to contain - Computer Controller wire

Extra Charge of \$12.00 Per Foot for Electrical Installation from breaker panel to exterior perimeter fence. For runs over 100 feet, call our office to discuss feasibility. To be calculated at completion of installation.

INSTALLATION & ASSEMBLY OF FENCING AND EQUINECISER PLEASE ADD

**\$250.00/
ARM**

PACKAGE B:

\$1,500.00

This price includes materials & labor for 2 days.

Installation & Assembly of the Equineciser

Installation & Assembly of the Fencing

On existing site. Grading, Concrete & Electrical done by others.

All work will be done by Centaur's Employees and/or agents.

PACKAGE C:

\$1,000.00

This price includes:

For 2 days of Supervision of 4 of your workers as they install the Equineciser & Fencing.

On existing site. Grading, Concrete & Electrical done by others.



Centaur Horse Walkers, Inc.

5761 Ridgeview Avenue
Mira Loma, Ca 91752
(951) 685-7337 • (951) 685-0341 Fax
1-800-962-8050
www.equinecisers.com

PACKAGE D:

Call for
Quote

Cantilevered Roof System at this time, we need to receive more information from you, to let us know exactly what you would like. Please call Alan, on his toll free voice mail pager 1-800-918-1077, to discuss the different options available, so that we can prepare a quote for you.

We need to know the following information from you:

Will you be pulling the permits for this job or not?

Do you want galvanized steel, or primered steel?

Do you want galvanized or painted standard HR-36 roof design or would you like steel simulated tile roofing?

Do you want gutters & downspouts?

PAD SITE MUST BE COMPLETELY LEVEL, PRIOR TO INSTALLATION.

66 Ft. round roof cover for a 60 ft. diameter equineciser

Price does NOT include freight or installation costs. Those will be quoted upon receipt of address.

Call for special pricing for your locations specific snow & wind loads.

Call for
Quote



Centaur Horse Walkers, Inc.

5761 Ridgeview Avenue

Mira Loma, Ca 91752

(951) 685-7337 • (951) 685-0341 Fax

1-800-962-8050

www.equinecisers.com

CENTAUR FREE FLOW EQUINECISER AVAILABLE OPTIONS

Fence & gate panels lined with our rubber matting material, to aid in soil retention. Standard height is 2 ft. in height. \$2,500.00

Fence & gate panels lined with our rubber matting material, to aid in soil retention. Standard height is 4 ft. in height. \$4,500.00

Installation of soil retention matting (labor only) \$500.00

Please Note: When most Graders and Grading Contractors hear 0% grade, they will grade at 1% to allow for proper drainage. While this is suitable for most buildings, it is **NOT** suitable for the Centaur Equinecisers. To install the fencing, and the screens properly there must be a **true 0% grade**. From 4 feet, outside of the diameter desired, and the diameter desired, the ground must be completely **FLAT**.

When we send our Project Manager to your jobsite to oversee the installation, or do all or part of the installation your pad site must be graded to 0%. Due to numerous installations where the grading was not done correctly he has had to layover, and incurred more costs than necessary. Now we have to charge an additional \$1,000.00 to our clients, should our Project Manager arrive at the jobsite, and the pad is not correct. This price is for food, lodging, truck & tool rentals for 2 additional days ONLY, thereafter it is \$500.00 per day.

The above prices are all based on geographical location of jobsite.

Should you choose any of the optional installation packages offered by Centaur, the above mentioned charges are NOT included in the prices, and will be added to the installation prices, if necessary.



Centaur Horse Walkers, Inc.

5761 Ridgeview Avenue

Mira Loma, Ca 91752

(951) 685-7337 • (951) 685-0341 Fax

1-800-962-8050

www.equinecisers.com

Centaur Free Flow Equinecisers Terms & Conditions of Supervised Installation

We offer to send a field project coordinator out to your Ranch for 2 days, to oversee your workers, & contractors, to make sure the pad is LEVEL, the electrical is wired correctly, & the cement is correct, and the fencing is installed correctly.

Your licensed electrician MUST BE there, during the installation process, to do the necessary final electrical connections.

This guarantees that the Equineciser will function properly, and allows us to familiarize you our client, with the Equineciser. Therefore we must rely on your understanding and help in supplying additional manpower, (2 to 3 people), and the necessary tools & equipment, outlined below:

Pipe wrench with jaws that open to a minimum of 3 ¼"

3 – Tall Ladders at least 8 Ft. Tall

1 – All Terrain Forklift with Pneumatic Wheels

Extensions for Forklift, to make the forks at least 6 Ft. long

½" Socket Set

Combination Wrench Set

Wire Strippers

Assorted Screwdrivers, both Phillips & Standard

Black Electrical Tape

Wire Snake

Our Project Coordinator will contact you two (2) weeks prior to the scheduled installation, to confirm that the project is ready for installation. If the installation has to be rescheduled due to customer delay, Centaur Horse Walkers, Inc., will confirm a new installation date at their discretion.

Due to numerous installations where the grading and/or the electrical was not done correctly, our Project Coordinator, has had to layover, and incurred more costs than necessary. Now we charge an additional \$1,000.00 to our clients, should our Project Coordinator arrive at the jobsite, and find the pad and/or electrical incorrect. This price is for food, lodging, truck & tool rentals for 2 additional days ONLY, thereafter it is, \$500.00 per day.

The above prices are all based on geographical location of jobsite, the prices could vary upwards. Should you choose one of the optional installation packages offered by Centaur, the above mentioned charges are NOT included in the prices, and will be added to the installation prices if necessary.



Centaur Horse Walkers, Inc.

5761 Ridgeview Avenue

Mira Loma, Ca 91752

(951) 685-7337 • (951) 685-0341 Fax

1-800-962-8050

www.equinecisers.com

If the Project Coordinator arrives on site on the appointed date, but the job site is not ready for installation of the Equineciser and/or Fencing, it is the customer's responsibility to arrange a new installation date at his/her expense. This may include, but is not limited to, additional time, travel & accommodations, which would be due in full upon completion of installation.

By Signing Below, you accept & understand the terms & conditions, stated above.

_____ Date _____

Printed Name



Centaur Horse Walkers, Inc.

5761 Ridgeview Avenue

Mira Loma, Ca 91752

(951) 685-7337 • (951) 685-0341 Fax

1-800-962-8050

www.equinecisers.com

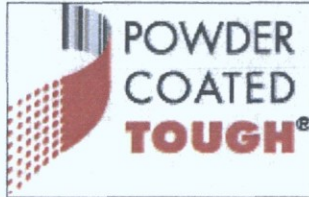

What is Powder Coating?

Powder coating is an advanced method of applying a decorative and protective finish to a wide range of materials and products that are used by both industries and consumers. The powder used for the process is a mixture of finely ground particles of pigment and resin, which is sprayed onto a surface to be coated.

The charged powder particles adhere to the electrically grounded surfaces until heated and fused into a smooth coating in a curing oven. The result is a uniform, durable, high-quality, and attractive finish. Powder coating is the fastest-growing finishing technology in North America, representing over 10% of all industrial finishing applications.

What Are Its Advantages?

More Durable

Powder coating gives consumers, businesses, and industry one of the most economical, longest-lasting, and most color-durable quality finishes available.

Powder coated surfaces are more resistant to chipping, scratching, fading, and wearing than other finishes. Color selection is virtually unlimited with high and low gloss, metallic, and clear finishes available. And colors stay bright and vibrant longer. Texture selections range from smooth surfaces to a wrinkled or matte finish, and rough textures designed for hiding surface imperfections.

Protects the Environment

Powder coating is also highly protective of our environment. While liquid finishes contain solvents which have pollutants known as volatile organic compounds (VOCs), powder coating contains no solvents and releases negligible amounts, if any, of VOCs into the atmosphere. Thus, there is no longer a need for finishers to buy costly pollution control equipment. In addition, most powder coating overspray that does not adhere to the part can be retrieved and reused, virtually eliminating the waste commonly found in liquid finishing processes.

Saves Money

Elimination of VOCs and reduction of wastes saves money and helps companies comply more easily and economically with the regulations of the U.S. Environmental Protection Agency.

In fact, one of the major elements in expanding the market for powder coating has been the implementation over the past 30 years of stringent air pollution control legislation.



Centaur Horse Walkers, Inc.

5761 Ridgeview Avenue

Mira Loma, Ca 91752

(951) 685-7337 • (951) 685-0341 Fax

1-800-962-8050

www.equinecisers.com

Where Is Powder Coating Used?

Thousands of products and parts are currently powder coated:

Appliances

The appliance industry benefits from powder coating on front and side panels of ranges and refrigerators, washer tops and lids, dryer drums, air-conditioner cabinets, water heaters, dishwasher racks, and cavities of microwave ovens. Powder coating has also replaced porcelain enamel on many washer and dryer parts.

Automotive

The automotive industry uses powder coating on wheels, bumpers, hubcaps, door handles, decorative trim and accent parts, truck beds, radiators, filters, and numerous engine parts. A clean powder topcoat has been developed to protect auto bodies. BMW and Volvo are using it on their new model cars, and GM, Ford, and Chrysler have formed a consortium to test this technique on their production lines.

Architecture/Building

The architectural and building market powder coats aluminum extrusions used on frames for windows and doors and modular furniture. Many highway and building projects use powder coating on light poles, guard rails, signs, posts, and fencing.

Everyday Products

There are also innumerable everyday uses for powder coated products such as lighting fixtures, antennas, and electrical components. Farmers have powder coated tractors and farm equipment. Fitness buffs use golf clubs and golf carts, ski poles and bindings, snowmobiles, bicycles, and exercise equipment that are powder coated. Shop owners have powder coated display racks, shelves, store fixtures, and vending machines. Office workers use metal furniture, computer cabinets, mechanical pencils and pens, thumbtacks, and other desk accessories that are powder coated. Parents have powder coated baby strollers, cribs, metal toys, and wagons. And home owners have lawn mowers, snow blowers, barbecue grills, patio furniture, garden tools, electronic components, bathroom scales, tool boxes, and fire extinguishers which benefit from a powder coated finish.



Centaur Horse Walkers, Inc.

5761 Ridgeview Avenue

Mira Loma, Ca 91752

(951) 685-7337 • (951) 685-0341 Fax

1-800-962-8050

www.equinecisers.com

Non-Metal Products

While powder coating started as an alternative to finishing metal products only, the development of powder that can be cured at lower temperatures has allowed powder coating to expand to non-metal surfaces such as ceramics and some wood and plastic applications. Powder coating on wood is growing by leaps and bounds. Manufacturers of home-office furniture, kitchen cabinets, children's furniture, and outdoor grill tables are discovering that powder coating makes these "hard use" products retain their new look much longer.

It Looks Like Paint But It Acts Like Armor

It's tough. It looks great. And it lasts a long, long time. Powder coating is a superior finish that's found on hundreds of products you come in contact with each day. It makes products durable, attractive, and scratch-resistant, too.

How Does It Work?

Powder coating is a dry finishing process. Finely ground particles of pigment and resin are electrostatically charged and sprayed onto the products to be coated.

The parts to be coated are electrically grounded, so that the charged particles adhere to them until melted and fused into a solid coating in a curing oven.

The result is an attractive, durable, high-quality finish. The powder coating process itself offers another advantage -- it is environmentally friendly...virtually pollution-free!

Unlike liquid paint, no solvents are used, so only negligible amounts of VOCs are released into the air. In addition, unused or over-sprayed powder can be recovered; so any waste is minimal and can be disposed of easily and safely.



SONORAN RANCH SERVICES



Telephone: (623)-693-0666

<http://www.sonoranranchservices.com>

[HOME \(/\)](#)

[DUMPSTER RENTAL \(/DUMPSTER-RENTAL.HTML\)](#)

[HORSE BEDDING \(/HORSE-BEDDING.HTML\)](#)

[RECYCLING \(/RECYCLING.HTML\)](#)

[SCHEDULE SERVICES ONLINE \(/SCHEDULE-SERVICES-ONLINE.HTML\)](#)

[CONTACT US \(/CONTACT-US.HTML\)](#)

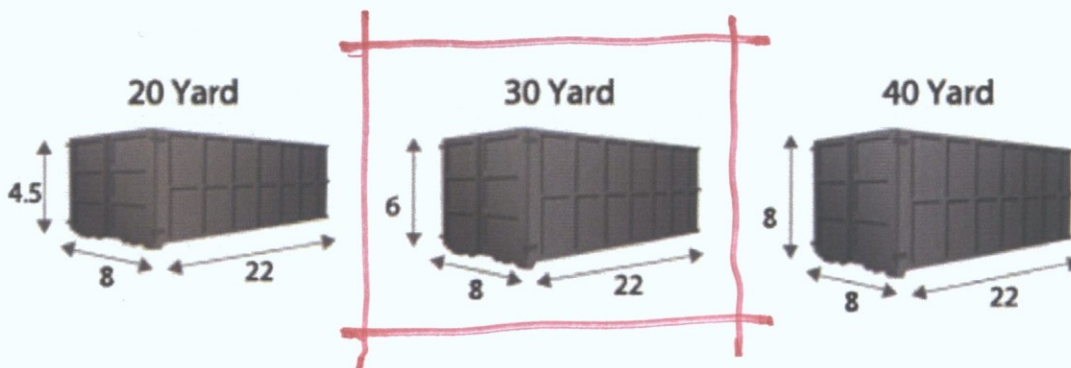

Dumpster Rental

- 20 yard 22x8x4.5 feet
- 30 yard 22x8x6 feet
- 40 yard 22x8x8 feet

We provide roll off dumpster services for residential, commercial and industrial jobs. We can accommodate your needs whether it be one time, temporary, monthly or permanent service we will be happy to help you.

We can help you decide on the right size dumpster for your job. Please call us today at **(623)-693-0666** for a quote and complete details about our roll-off services.

MANURE/REFUSE DUMPSTER - PROPOSED



SONORAN RANCH SERVICES

Telephone: (623)-693-0666



CONTACT US

Please contact us with any questions you may have. Thank you and have a wonderful day.

HOURS OF OPERATION:

Mon - Fri 7:00a .m.-5:00 p.m.

Saturday 7:00 a.m. - 2:00 p.m.

MAILING ADDRESS:

515 E. Carefree Hwy. #169

Phoenix, AZ 85085

TELEPHONE NUMBERS:

(623)693-0666 Brandon (General, Sales, Scheduling)

E-MAIL CONTACT:

srservicesaz@gmail.com

40-DR-2016
8/12/16

MANURE/REFUSE DUMPSTER-PRODUCT DATA



FLY TARIFF - PROPOSED



SONORAN RANCH SERVICES



Telephone: (623)-693-0666

<http://facebook.com/sonoranservices>

[HOME \(/\)](#)

[DUMPSTER RENTAL \(/DUMPSTER-RENTAL.HTML\)](#)

[HORSE BEDDING \(/HORSE-BEDDING.HTML\)](#)

[RECYCLING \(/RECYCLING.HTML\)](#)

[SCHEDULE SERVICES ONLINE \(/SCHEDULE-SERVICES-ONLINE.HTML\)](#)

[CONTACT US \(/CONTACT-US.HTML\)](#)

GRINDINGS/SHAVINGS



We offer bulk grindings and shavings loads in 20,30, and 40 yard quantities. We also offer manure removal and disposal.

Please call us today for pricing (623)-693-0666



TM_SOURCE=INTERNAL&UTM_MEDIUM=FOOTER&UTM_CAMPAIGN=3)



SONORAN RANCH SERVICES



Telephone: (623)-693-0666

<http://www.sonoranranchservices.com>

[HOME \(/\)](#)

[DUMPSTER RENTAL \(/DUMPSTER-RENTAL.HTML\)](#)

[HORSE BEDDING \(/HORSE-BEDDING.HTML\)](#)

[RECYCLING \(/RECYCLING.HTML\)](#)

[SCHEDULE SERVICES ONLINE \(/SCHEDULE-SERVICES-ONLINE.HTML\)](#)

[CONTACT US \(/CONTACT-US.HTML\)](#)

Recycling Services

At Sonoran Ranch Services we strive to protect our environment. We are committed to providing our customers with a convenient cost effective method of recycling.

Sonoran Ranch Services recycles the following materials:

- *MANURE
- *WOOD
- *GREEN WASTE
- *CARDBOARD
- *PLASTIC
- *METAL
- *ALUMINUM
- *DIRT



Call us today at (623)-693-0666 for a quote and complete details about the recycling services that we offer.

