

**From:** [Morrison, Adam](#)  
**To:** [Kelly, John](#)  
**Subject:** Fw: Residential golf net application 4-BA-2025  
**Date:** Friday, March 28, 2025 11:02:46 AM  
**Attachments:** [Outlook-o1ojs4cw.png](#)

---



**PLANNING & DEVELOPMENT**  
**Adam Morrison | Associate Planner**  
7447 E. Indian School Rd, Ste 105  
Scottsdale, AZ 85251

---

**From:** Kyle Ryan <kylerryan21@gmail.com>  
**Sent:** Friday, March 28, 2025 7:01 AM  
**To:** Morrison, Adam <amorrison@scottsdaleaz.gov>  
**Subject:** Residential golf net application 4-BA-2025

**External Email: Please use caution if opening links or attachments!**

As someone who lives nearby, I am writing to express my full support for Case # 4-BA-2025 for the Fannin residence. Golf balls fly off of this course often and be a great danger, or at best, a nuisance. This is a reasonable request to protect their home. Please help protect not only the home but the residents as well. As a golfer myself I've seen a much higher number of homes being damaged by new golfers. This wasn't the case for years as my home was rarely hit before but within the past year its spiked exponentially.

This application has our full support. Please approve!

Thank you!

Kyle

**From:** [WebServices](#)  
**To:** [Board Of Adjustment](#); [Projectinput](#)  
**Subject:** Board of Adjustment Public Comment  
**Date:** Monday, March 24, 2025 4:53:38 PM  
**Importance:** High

---

**Name:** Amy Bessen  
**Address:** 10659 E Palm Ridge Dr, Scottsdale 85255  
**Email:** [amy.bessen@gmail.com](mailto:amy.bessen@gmail.com)  
**Phone:** (480) 550-0438

**Comment:**

**Hi. I am writing to express my concern about the Zoning Ordinance Variance for Case: The Fannin Residence Net. I am opposed to approving this variance. We live on the end of the cul de sac on Palm Ridge Drive and the front of our house has views to the golf course and the Fannin property. When the Net as first installed, I noticed right away that it obstructed our view. From the write up of one of the other owners who provided feedback, it seems that the golf course has not materially changed. And why would they not have had get approval if they were going to make a substantial change. So, the owner of the property knew that they were buying a house on the golf course. Even if you were to approve this variance, the net color is against the HOA approved colors. Perhaps if the net was in a more neutral color, it might not stand out as much. Also, is there a way to lower the net even more so it doesn't stick out so much? I hope this variance is not approved. It will set a precedent that will allow others to install similar structures on their property.**

**From:** [WebServices](#)  
**To:** [Board Of Adjustment](#); [Projectinput](#)  
**Subject:** Board of Adjustment Public Comment  
**Date:** Wednesday, March 19, 2025 4:17:45 PM  
**Importance:** High

---

**Name:** Mike Greenwood  
**Address:** 14153 N 106TH PL, Scottsdale, AZ 85255  
**Email:** [newsvet@yahoo.com](mailto:newsvet@yahoo.com)  
**Phone:**

**Comment:**

**Comment regarding a Zoning Ordinance Variance 5.304.G As a homeowner residing on the McDowell Mountain Golf Course (MMGC), I understand the benefits and risks of living on a golf course. I understand the inevitability of errant golf shots ending up in my property and even striking my home. Being an adult that accepts the responsibilities of my choices, I don't expect for the City of Scottsdale to accommodate me as a result of my choices. The homes around the first and ninth golf holes at MMGC have been a place to enjoy spectacular views and serenity without obstruction for more than 20 years. Making the decision to live on a golf course in a home that has been in the same place for more than 20 years and now deciding to obstruct the views and serenity of the neighbors is ridiculous and downright childish. What is the beginning and the end of obstructing views throughout the 4600 homes in the McDowell Mountain area once such an accommodation is made to one person that doesn't accept the responsibility of their choices? And why should anyone living around one homeowner be subject to a change of rules that they didn't seek? The oversized fence recently built on the property is bad enough. I disagree with raising the fence to 20' or any height above where it currently stands.**

# BOARD OF ADJUSTMENT REPORT



Meeting Date: 4/2/2025

## ACTION

### The Fannin Residence Net 4-BA-2025

#### Request to consider the following:

1. Request by owner for a variance to the City of Scottsdale Zoning Ordinance Section 5.304.G. to amend the height restriction for walls, fences, and hedges along the rear property line from 8'-0" to 20'-0" to allow for a 20'-0" high golf ball net (fence) for a property located at 14062 N 106th Way with Single-family Residential Environmentally Sensitive Lands (R1-18 ESL) zoning.

## OWNER

Michael Fannin  
(602) 260-0600

## APPLICANT CONTACT

George Pasquel III  
(602) 230-0600

## LOCATION

14062 N 106<sup>th</sup> Way

## BACKGROUND

### History

The subject site was annexed into the City of Scottsdale in 1972 through Ordinance No. 645, and the City of Scottsdale Single-family Residential Environmentally Sensitive Lands (R1-18) ESL zoning was applied. The property is Lot 195 of the Sienna Canyon subdivision, which was platted in 1998. The original main residence appears on historical aerials in 2003, and the County Assessor's records identify the house being constructed in 2003. The original eight (8) foot tall wall/fence surrounding the subject property was approved with building permit #80281 and also constructed in 2003. After some time, the property owner sought approval from the HOA to construct a smaller protective netting that exceeded the eight (8) foot

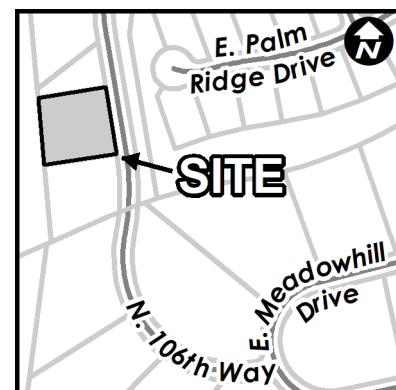

maximum height allowance and were granted the request from the HOA. This small protective net first appears in the city's 2014 aerials and has remained on-site since then, up until its height was increased to its current condition today, at approximately twenty (20) feet in height.

### **Zoning/Development Context**

The subject parcel is zoned Single-family Residential Environmentally Sensitive Lands (R1-18 ESL) and is located on the west side of N 106<sup>th</sup> Way and to the north of the cross street of E Meadowhill Drive.

### **Adjacent Uses and Zoning**

- North: Sienna Canyon Subdivision, zoned Single-family Residential Environmentally Sensitive Lands (R1-18 ESL); Tract G - Common Area.
- South: Sienna Canyon Subdivision, zoned Single-family Residential Environmentally Sensitive Lands (R1-18 ESL); existing single-family residence.
- East: Sienna Canyon Subdivision, zoned Single-family Residential Environmentally Sensitive Lands (R1-18 ESL); Tract J – Common Area.
- West: Sienna Canyon Subdivision, zoned Single-family Residential Environmentally Sensitive Lands (R1-18 ESL); Tract D – Common Area & Open Space (golf course).

### **Zoning Ordinance Requirements**

Pursuant to Section 5.304.G. of the City of Scottsdale Zoning Ordinance, pertaining to the maximum height of walls, fences, and hedges within the required rear yard for the single-family residential lot: Walls, fences and hedges up to eight (8) feet in height are allowed on the property line or within the required side or rear yard.

*The applicant is requesting a variance to amend the maximum height of walls, fences, and hedges within the required rear yard from eight (8) feet to twenty (20) feet on the western (rear) property line to bring the existing twenty (20) foot tall protective netting into conformance. The requested variance is to bring the existing protective net into conformance only.*

### **Code Enforcement Activity**

At the time the of drafting this report, this variance request is a result of an active code enforcement case on the subject property. This site has had no previous code enforcement activity other than the existing case.

### **Community Input**

The City has sent out hearing postcards to properties within 750 feet of the subject site and posted a sign at the subject site. The code enforcement case was a result of a complaint from a Sienna Canyon resident within the vicinity of the subject property. At the time of drafting this

report, multiple letters of support and multiple letters of opposition have been received from the surrounding properties, including one in support from the property owner residing directly adjacent to the south at 14020 N 106<sup>th</sup> Way. No other public comments have been received.

### **Discussion**

The main residence was constructed in 2003 and built at a slight angle on the subject property that sits along an active golf course fairway. Along with the main residence construction, site walls/fences were also constructed that met all the necessary requirements at the time. The current property owner has lived in the subject property since its construction in 2003.

As mentioned above, after the construction of the initial permitted wall/fence, the homeowners approached the HOA for approval to build a small protective net along the northern and western property lines that slightly exceeded the height limit allowed per zoning requirements. According to the property owner, this request was granted by the Sienna Canyon Community HOA and the netting was constructed without a permit from the City of Scottsdale. This smaller netting first appears in the 2014 aerials. The applicant has stated that, within recent years, the golf course has made changes to the playing hole on which the subject property sits, resulting in its more recurrent bombardment with errant golf balls. The applicant has stated that the golf course was not in communication with the property owners about this change before it occurred. Upon this change, the applicant again approached the HOA for approval to build a higher protective netting on property that reached up 30'-0" in height at its maximum. This request was granted by the HOA in 2024, and their approval was contingent on the property owner receiving the necessary permits from the City of Scottsdale for the construction of this protective netting. No permits were provided from the city for this protective netting at the time, and the large protective netting was constructed in 2024.

The applicant has since agreed to lower the height of all portions of the unpermitted protective netting to 20'-0" and is now seeking to bring the portion of the netting that encroaches into the required rear yard into conformance through a variance. Due to the limitations of Section 5.304.G. pertaining to the maximum height allowance for walls, fences, and hedges within a required rear yard, the existing protective netting within the required rear yard is non-conforming and the proposal cannot be approved without a variance. As mentioned above, the applicant is requesting a variance to the required maximum height allowance within a required rear yard along the western property line to bring the existing protective netting into conformance. As requested, the variance would only apply to the maximum wall, fence, and hedge height allowance within a required rear yard for the portion of existing wall/fence along the western property line. The portion of netting along the north property line is allowed, since it is set back far enough from the property line that it is within the main building envelop of the subject site.

## VARIANCE CRITERIA ANALYSIS

---

- 1. That because of special circumstances applicable to the property including its size, shape, topography, location, or surroundings, the strict application of the zoning ordinance will deprive such property of privileges enjoyed by other property of the same classification in the same zoning district:**

Applicant Statement:

Special circumstances exist and are applicable to this property. Specifically, its location along a golf course, mid-fairway and, even more specifically, along a playing hole which has recently been modified, the results of which have endangered the Property occupants. While there may be a fair number of properties in the City with R1-18, ESL zoning which are located along a golf course, a much smaller number are located mid-fairway and, (it would be reasonable to conclude), an exceedingly rare number have been placed in this circumstance - where changes occurring off of their Property have resulted in such a dramatic and damaging bombardment of golf balls.

Staff Analysis:

The subject parcel is zoned Single-family Residential Environmentally Sensitive Lands (R1-18 ESL) and is located on the west side of N 106<sup>th</sup> Way and to the north of the cross street of E Meadowhill Drive. The amended development standards for this R1-18 ESL zoning district requires a minimum lot area of 9,500 square feet. The subject property is a larger sized lot and is approximately 22,348.89 square feet. The property is similar in shape and topography to all other properties within the Desert Estates Unit Two subdivision and other properties within this R1-18 ESL amended standards zoning district. The property does, however, sit on the fairway of an active golf course, making its location and surroundings somewhat unique when compared to other parcels within the subdivision. Aside from the large protective netting, the main residence and site walls have existed in their current state since the time of the property's construction. Without the granting of a variance, the applicant's protective netting would not be permitted to remain on property due to the wall/fence height restrictions outlined Section 5.304.G.

- 2. That the authorization of the variance is necessary for the preservation of privileges and rights enjoyed by other property of the same classification in the same zoning district, and does not constitute a grant of special privileges inconsistent with the limitations upon other properties in the vicinity and zone in which such property is located:**

Applicant Statement:

It would be reasonable to expect a modicum of comfort and safety within one's own backyard. The Fannin's had such a condition, until changes occurred (by no action of their own) that dramatically reduced that comfort and safety. It is not a "special" privilege to be able to safely reside in one's own backyard. It is also not a "special" privilege to enjoy peace

inside one's home without the loud, thudding noise of golf balls hitting the house at irregular intervals. The Fannin's have also had to endure near constant expenses to repair stucco, paint, doors and windows resulting from the barrage of golf balls.

The solution proposed is also reasonable and necessary for the preservation of basic property rights. It is not uncommon to see golf ball nets at residential (and commercial) properties as a common solution. A net constructed at the allowable 8-foot height does not provide protection. A net located 30-feet off the rear property line (in conformance with the required 30-foot setback) would leave a large portion of the Fannin's backyard unprotected (and therefore unusable).

Staff Analysis:

No similar variances have been attempted or granted within the vicinity of this subject property. All other properties within this R1-18 ESL district are subject to the same strict rear yard wall/fence height restrictions. The character of the neighborhood is relatively similar throughout, with other properties also orienting themselves in a similar manner on their respective lots that front golf courses and continuing to meet the required rear yard wall/fence height restrictions stipulated per zoning requirements.

**3. That the special circumstances applicable to the property were not self-imposed or created by the owner or applicant:**

Applicant Statement:

The conditions described were not self-imposed. They are a direct result of changes made on the adjacent golf course property - something the Fannin's have no control over. The conditions did not exist at the time of purchase. If so, they most certainly would not have purchased the home.

Staff Analysis:

As previously stated, the subject property is a lot of similar shape and topography, with a slightly larger size, to that of other properties within the Sienna Canyon subdivision. It contains the minimum parcel area and has the minimum lot width as required by this R1-18 ESL zoning district. The property does, however, sit on the fairway of an active golf course, making its location and surroundings somewhat unique when compared to other parcels within the subdivision and zoning district. Based on the applicant's statements, it appears there has been an increase in the amount of stray golf balls entering the subject property due to a change made by the golf course, which the applicant did not have any involvement in.

**4. That authorization of the variance will not be materially detrimental to persons residing or working in the vicinity, to adjacent property, to the neighborhood or to the public welfare in general:**

Applicant Statement:

The proposed location of the net will in no way be materially detrimental to others in the vicinity. In fact, the difference in height - (or difference in location if located outside of the rear setback) - will be fairly undiscernible to the general public. It is important to remember, the installation of a golf ball safety net is permitted, as is the height being proposed if at a different location. The location and height proposed on the north side of the home is permitted by right. The only request is for some additional height for the portion of the net located within the rear setback. This small difference will in no way be materially detrimental to others but will mean all the world to the Fannin's.

Staff Analysis:

The authorization of the request to increase the maximum wall, fence, and hedge height to twenty (20) feet within the required rear yard would allow the existing protective netting to remain. Given the intent of the required wall/fence height restrictions within a required rear yard to establish safety and privacy, and the fact that the tract directly adjacent to the north is Common Area Open Space, this does not appear as though it would be directly detrimental to persons residing in the vicinity. The request for twenty (20) foot high protective netting within the required rear yard does not appear as though it would significantly impact the character of the golf course fronting neighborhood. While the existing twenty (20) foot high protective netting within the rear yard would still exceed the height limitation, the netting itself is constructed of mesh and has a transparent appearance when viewed from a distance. The applicant's request for a 20-foot-tall protective net within the rear yard will provide the desired protection from errant golf balls while generally not posing a significant nuisance to the surrounding neighborhood.

**SUMMARY**

---

Based on the facts presented by the applicant, the evidence would support a finding that the property may have special circumstances that would warrant relief from the strict application of the Zoning Ordinance requirements. The size, shape, and topography are not unique and applicable, however, the location and surroundings of the property may be unique and applicable. Further, the applicant's proposed variance does not appear that it would be detrimental to persons residing or working in the surrounding neighborhood. However, the decision about whether the criteria have been met is for the Board to make after hearing all the evidence at the hearing.

If the Board chooses to grant the requested variance, staff recommends a stipulation that the variance only be applicable to the existing 20'-0" protective net fencing that exists within the required rear yard, as shown on the site plan included in Attachment #7, and that it must obtain a permit through final plans submittal.

**APPROVED BY**

---



---

Adam Morrison, Report Author  
480-312-4218, amorrison@scottsdaleaz.gov

03/18/2025

---

Date



---

Bryan Cluff, Planning & Development Area  
Manager, Board of Adjustment Liaison  
480-312-2258, bcluff@scottsdaleaz.gov

3/17/2025

---

Date



---

Tim Curtis, AICP, Current Planning Director  
480-312-4210, tcurtis@scottsdaleaz.gov

3/17/2025

---

Date



---

Erin Perreault, AICP, Director  
Planning and Development Services  
480-312-7093, eperreault@scottsdaleaz.gov

03/18/2025

---

Date

**ATTACHMENTS**

---

1. Project Description & Justification
2. HOA Approval Letter
3. Context Aerial
4. Aerial Close-Up
5. Zoning Map
6. Site Photographs
7. Proposed Site Plan
8. City Notification Map
9. Public Comment



January 29, 2025

**Via Hand Delivery**

Board of Adjustment  
Planning & Development Services Department  
City of Scottsdale  
7447 E. Indian School Road, Suite #105  
Scottsdale, Arizona, 85251

Re: Variance Application for the Location of Safety Net at 14062 N. 106th Way, Scottsdale, Arizona, Assessor Parcel #217-65-618 (the "Property") - (Final v3)

Dear Board of Adjustment Members:

Our office represents Michael and Bonnie Fannin regarding their home at 14062 N. 106th Way in Scottsdale. As explained herein, special and unique conditions apply to the Property which necessitate action (a variance) to not only preserve basic property privileges, but to provide essential safety to the Fannins and anyone that might visit their home. Specifically, the home's rear yard abuts the adjacent McDowell Mountain Golf Course. Recent changes to the course design have created an unsafe environment in which stray golf balls are continuously bombarding the home and property. The Fannins would like to install a golf ball safety net, a portion of which would be located within the required rear yard setback.

**I. Property**

The lot in questions is roughly 22,000 square feet in size located within the Sienna Canyon development in Scottsdale. The Property is zoned R1-18, ESL and is currently developed with a roughly 3,600 square foot, single-family home constructed in 2003. See aerial and zoning exhibits enclosed at **TAB A**.

**II. Variance Requested**

A variance to allow a golf ball safety net in the rear yard (west property line) up to a height of 20-feet. Maximum 8-feet permitted. **Section 5.304.G**.

**III. Background**

As a homeowner situated near a golf course, our client understands a reasonable amount of inherent risk of errant golf balls. Back in 2014, the Fannins received HOA

approval for the construction of a small protective net. This worked fine for a while. In recent months, however, the frequency and severity of the bombardment has become incredibly dangerous and past acceptable. The condition is so extreme, they can no longer safely enjoy their backyard - and even portions of the interior of the house have become unsafe as golf balls have shattered through windows. A small sampling of images of the ongoing damage are enclosed herein at **TAB B**. (Many additional images can be provided as well if necessary).

The Fannins, at their own time and expense, have taken multiple steps to try and stop, or at least reduce the assault. Besides the small protective net mentioned above, they also installed eight (8) trees on the north side of the Property. Then, when that failed to provide adequate safety, they added additional trees in between these locations to try and thicken the protective growth, but to no avail. They then added two (2) Ficus trees at the northwest corner of the Property. These actions have still failed to stop the assault.

The Fannins then obtained bids and HOA approval (again) for the construction of a 30-foot maximum height protective net. (See enclosed 30-foot approval documents at **TAB C**). The protective golf ball net is located along the north yard of the house (a side yard) and a small portion along the west property line (the rear yard). The net was planned to be 30 feet in height for the 5 poles near the northwest corner of the house - (the most dangerous location where most balls enter the property) - and reduced down to 20 feet in height along the remainder of the north side of the house. (Please note, the approved drawings at **TAB C** depict a 30-foot height net. At this time, our client is proposing to reduce all the poles down to 20 feet as noted in **Section IV** below).

While under construction of the 30-foot net, the Fannins received a Compliance Notice from the City noting that permits are required to erect such a net. See Compliance Notice enclosed at **TAB D**. They immediately ceased work and while attempting to obtain a permit, were informed the net was subject to setback regulations which the current design violated. The net location complies with the side yard (north) setback requirements (minimum 10 feet required) but is located within the rear yard (west) setback requirement (minimum 30 feet required).

#### **IV. A Reasonable Solution for Safety**

As this time, the Fannins are proposing to reduce all of the poles down from 30 feet to 20 feet in height. In fact, they have dismantled the 30-foot sections that were installed prior to the Compliance Notice and all poles are now at 20 feet as seen in the exhibits enclosed at **TAB E**. It should be noted, the maximum height permitted in R1-18 is 30 feet while the ESL maximum height is 24 feet. So, the proposed height of 20-feet is below the maximum height at which a home could be constructed in this zoning district. The Ordinance also permits 8-foot walls within the rear setback, but a protective net at that height clearly does not provide adequate safety. The Fannins are requesting an additional 12-feet of height to help protect their property, themselves and their guests.

## V. APPROVAL CRITERIA

The requested variance meets or exceeds the four (4) approval criteria as set forth in Section 1.804 of the Zoning Ordinance, specifically:

- 1) *That because of special circumstances applicable to the property including its size, shape, topography, location, or surroundings, the strict application of the zoning ordinance will deprive such property of privileges enjoyed by other property of the same classification in the same zoning district:*

Special circumstances exist and are applicable to this Property. Specifically, its location along a golf course, mid-fairway and, even more specifically, along a playing hole which has recently been modified, the results of which have endangered the Property occupants. While there may be a fair number of properties in the City with R1-18, ESL zoning which are located along a golf course, a much smaller number are located mid-fairway and, (it would be reasonable to conclude), an exceedingly rare number have been placed in this circumstance – where changes occurring off of their Property have resulted in such a dramatic and damaging bombardment of golf balls.

- 2) *That the authorization of the variance is necessary for the preservation of privileges and rights enjoyed by other property of the same classification in the same zoning district, and does not constitute a grant of special privileges inconsistent with the limitations upon other properties in the vicinity and zone in which such property is located.*

It would be reasonable to expect a modicum of comfort and safety within one's own backyard. The Fannins had such a condition, until changes occurred (by no action of their own) that dramatically reduced that comfort and safety. It is not a "special" privilege to be able to safely reside in one's own backyard. It is also not a "special" privilege to enjoy peace inside one's home without the loud, thudding noise of golf balls hitting the house at irregular intervals. The Fannins have also had to endure near constant expenses to repair stucco, paint, doors and windows resulting from the barrage of golf balls.

The solution proposed is also reasonable and necessary for the preservation of basic property rights. It is not uncommon to see golf ball nets at residential (and commercial) properties – this is a common solution. A net constructed at the allowable 8-foot height does not provide protection. A net located 30-feet off the rear property line (in conformance with the required 30-foot setback) would leave a large portion of the Fannin's backyard unprotected (and therefore unusable).

- 3) *That the special circumstances applicable to the property were not self-imposed or created by the owner or applicant:*

The conditions described were not self-imposed. They are a direct result of changes made on the adjacent golf course property – something the Fannins have no control over. The conditions did not exist at the time of purchase. If so, they most certainly would not have purchased the home.

- 4) *That authorization of the variance will not be materially detrimental to persons residing or working in the vicinity, to adjacent property, to the neighborhood or to the public welfare in general:*

The proposed location of the net will in no way be materially detrimental to others in the vicinity. In fact, the difference in height - (or difference in location if located outside of the rear setback) - will be fairly undiscernible to the general public. It is important to remember, the installation of a golf ball safety net is permitted, as is the height being proposed if at a different location. The location and height proposed on the north side of the home is permitted by right. The only request is for some additional height for the portion of the net located within the rear setback. This small difference will in no way be materially detrimental to others but will mean all the world to the Fannins.

## **V. CONCLUSION**

Given the above noted conditions and unique circumstances, strict application of the zoning Ordinance would deprive this Property and these homeowners of the substantial property rights and privileges enjoyed by others. The granting of this request will by no means be materially detrimental to others but will have significant and positive implications upon the homeowners. We look forward to discussing this application with the Board and respectfully request your approval.

Sincerely yours,  
WITHEY MORRIS BAUGH, P.L.C.

By   
George Pasquel III

Enclosure: application exhibits and materials

# Tab A

# Aerial Map

- APN: 217-65-618
- Sienna Canyon Subdivision
- Zoning = R1-18, ESL

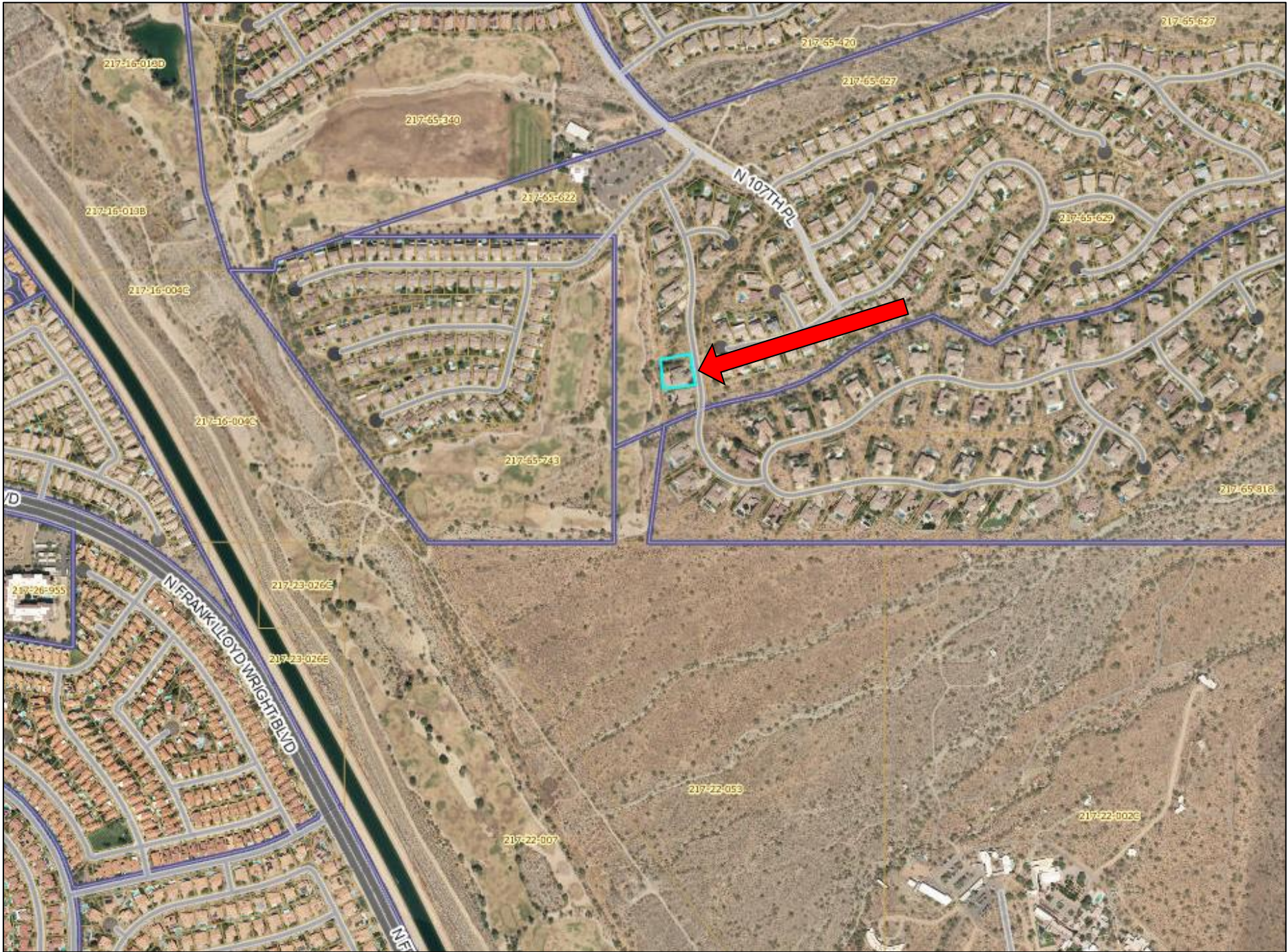

# Aerial Map

- APN: 217-65-618
- Sienna Canyon Subdivision
- Zoning = R1-18, ESL

Hole No. 1



# Aerial Map

- APN: 217-65-618
- Sienna Canyon Subdivision
- Zoning = R1-18, ESL

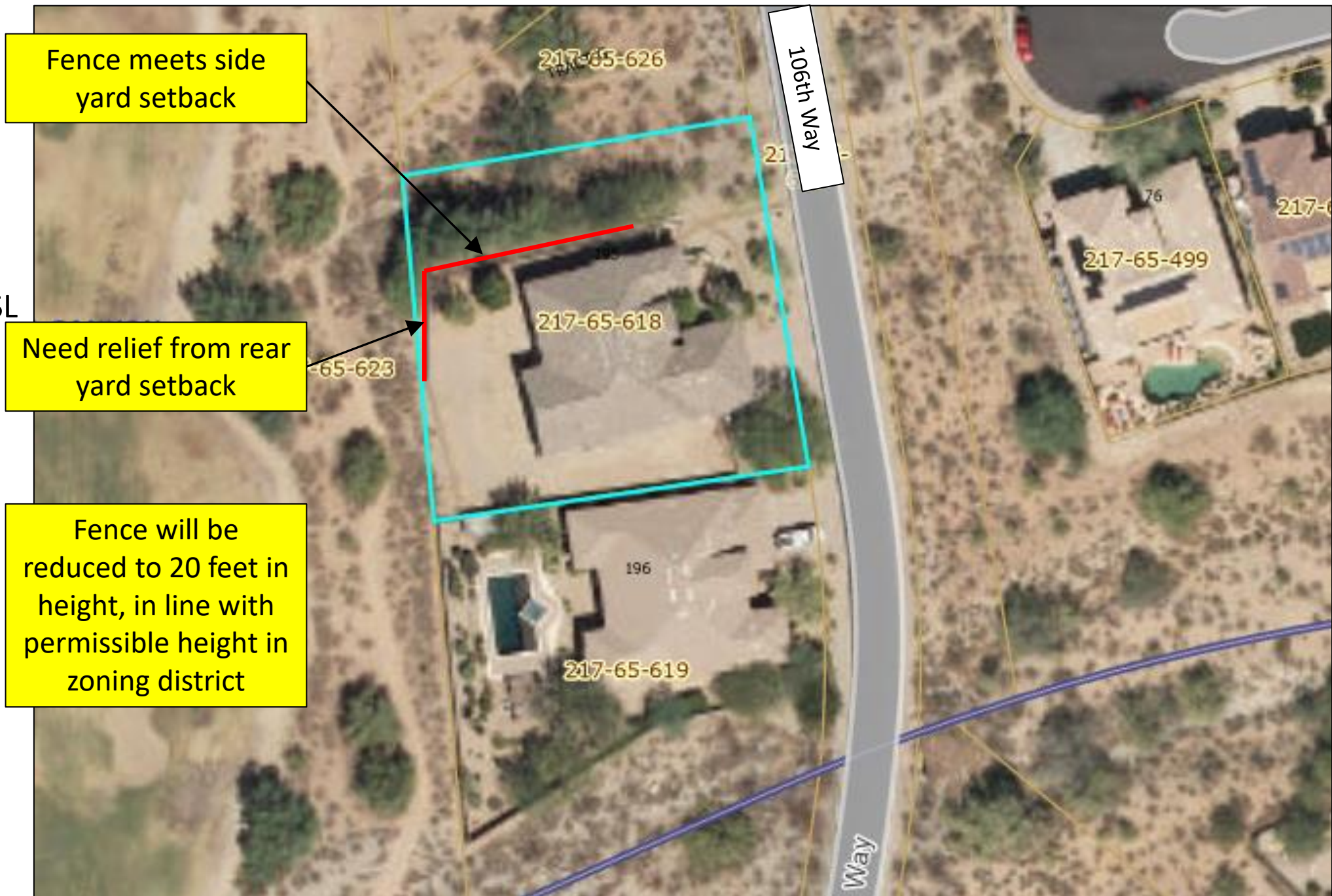

Fence meets side yard setback

Need relief from rear yard setback

Fence will be reduced to 20 feet in height, in line with permissible height in zoning district



# Tab B

# Sample Damage



# Sample Damage

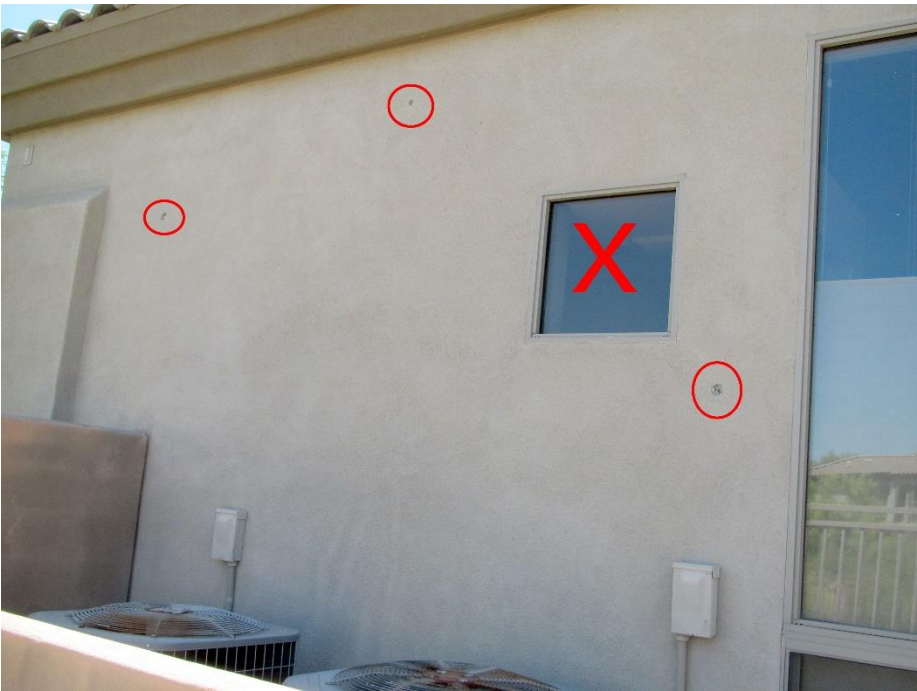

Repairing damage with new stucco job



# Tab C

# McDowell Mountain Ranch Community Association

16116 N McDowell Mountain Ranch Rd  
Scottsdale, AZ 85255

Phone: 480-473-0877

---

Michael E Fannin  
14062 N 106th Way  
Scottsdale, AZ 85255-1761

RE: Architectural Submittal for 14062 N 106th Way  
Account#: 1456430  
Submittal: Screen Enclosure Beyond Existing

June 13, 2024

Dear Michael E Fannin,

Your recent request to install a golf screen on the North and West side of your property has been reviewed and **APPROVED WITH STIPULATIONS**. The stipulations are outlined below:

**Proposal #2 has been approved - 30' for first 5 poles on most West side of property, 20' for remaining poles on East side of property. The existing trees shall be maintained for proper screening.**

This approval is subject to all County, City, State and Federal permits, codes, statutes, laws, rules, and regulations, which are the sole responsibility of the homeowner. This approval shall not be deemed a warranty or representation as to the quality of the construction, installation, addition, alteration, repair, change or other work.

Upon the completion of the approved project, please notify McDowell Mountain Ranch Community Association. Management reserves the right to inspect the completed work to ensure the project was completed as submitted.

Should you have any questions, please feel free to contact me at 480-473-0877 or by email at [crichardson@associatedasset.com](mailto:crichardson@associatedasset.com). We thank you for your patience with this process.

Sincerely,

Chris Richardson  
Community Manager  
For the Architectural Committee of  
McDowell Mountain Ranch Community Association

RESIDENCE  
BACKYARD



NOTE(S):

- STRUCTURE TO BE OFFSET FROM EXISTING FENCE BY 2'-0"
- NEW STRUCTURE TO BEGIN AT POLE #3 IN CURRENT POLE LOCATION ONCE REMOVED.

NET #	HEIGHT	LENGTH
2	20' -0"	49.5'
1	20' -0"	46' -0"
3	20' -0"	29' -0"

① PLAN VIEW  
② SCALE: NOT TO SCALE

	<b>FANNIN RESIDENCE NEW NETTING</b>	
	PROJECT LOCATION: 14062 N. 106th Way Scottsdale, AZ 85260	SCALE: NTS
SHEET NUMBER  <b>2</b>  DRAWN BY: KR	CONTACT INFORMATION: Mike Fannin(602)-448-4460 mefannin@cox.net	DATE: 05/06/2024
		REVISED: N/A
This drawing represents visual concepts and construction suggestions based on industry standards. Nets Unlimited does not assume responsibility for damage caused by neglect or misuse, whether intentionally or unintentionally.		
NETS Unlimited, Inc. · 20625 N. 29TH PL. · PHOENIX, AZ 85050 (480)515-1300 · SALES@NETSUNLIMITED.COM		

NORTH  
FACING  
PANELS

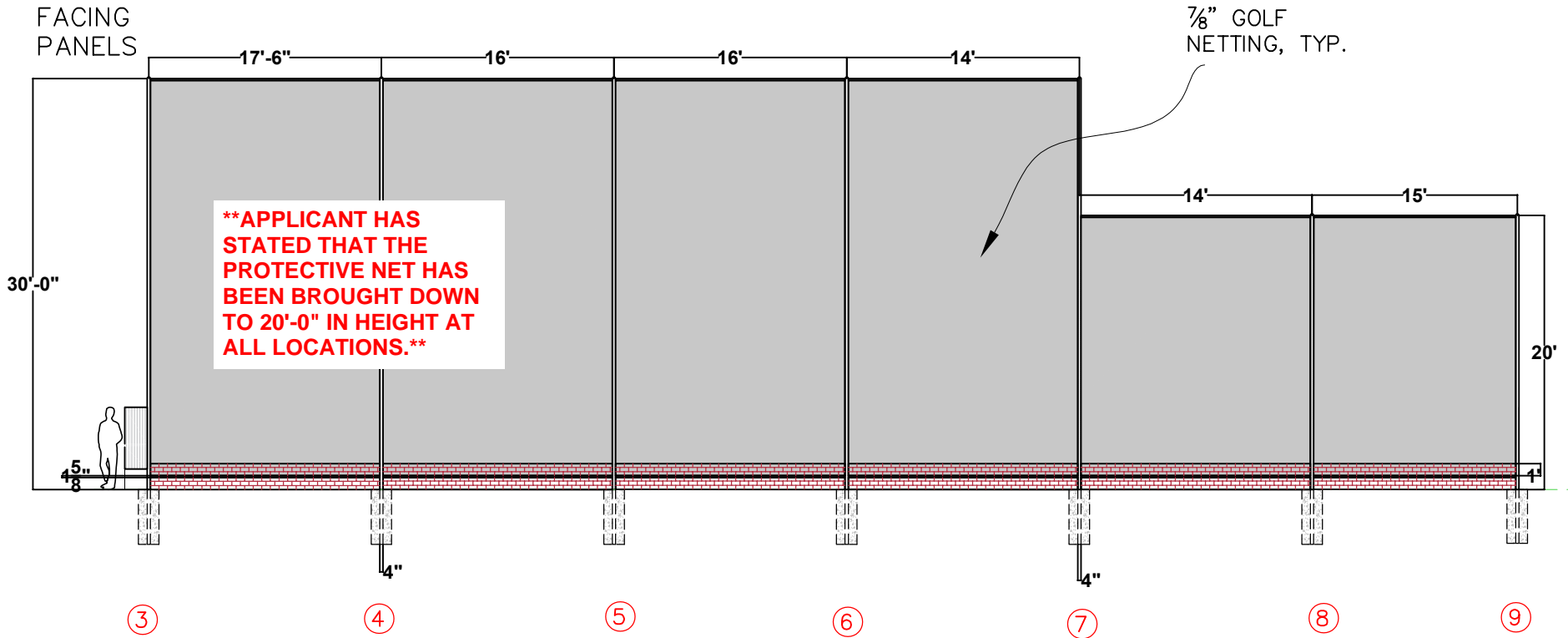

① — ELEVATION  
③ — SCALE: NOT TO SCALE



- NOTE(S):
- STRUCTURE TO BE OFFSET FROM EXISTING FENCE BY 2'-0"
  - SEE PAGE 5 FOR CONCRETE FOOTER & STRUCTURE DETAILS
  - BOTTOM HORIZONTAL RAIL TO BE 1' BELOW TOP OF BLOCK FENCE

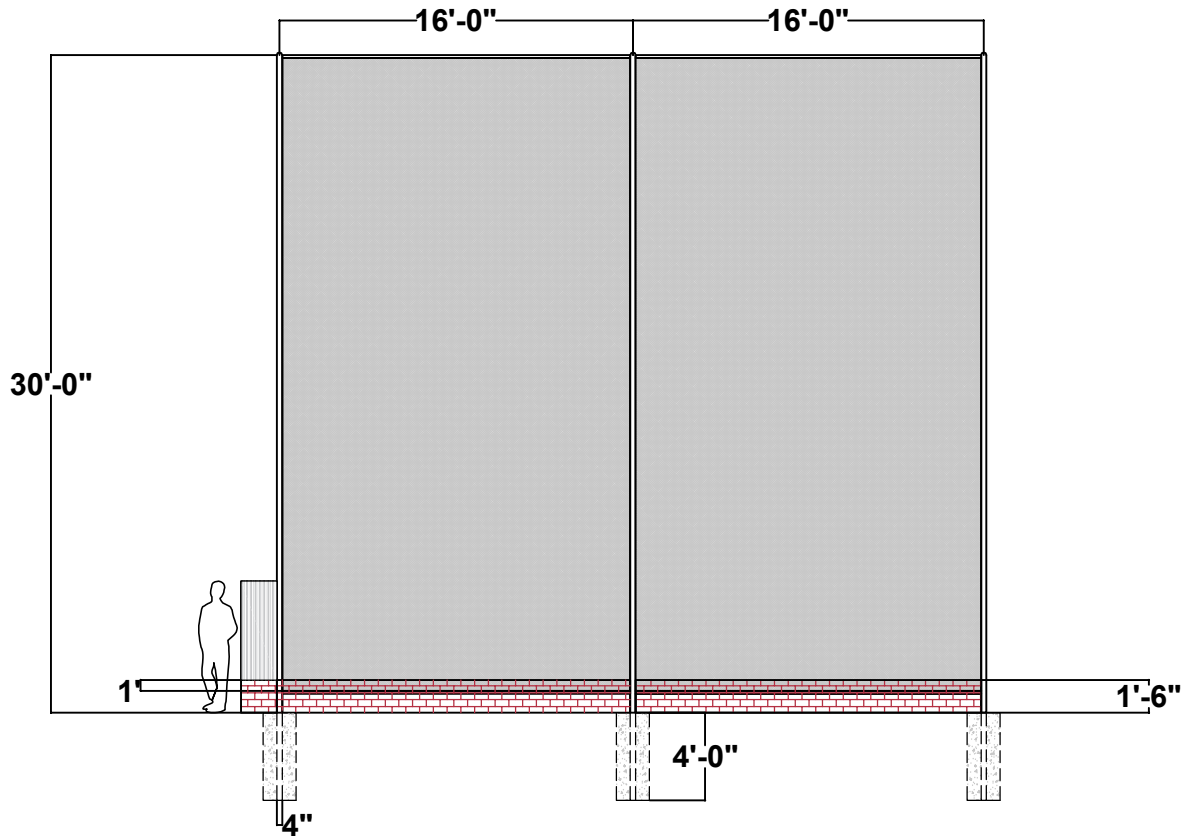

	<b>FANNIN RESIDENCE NEW NETTING</b>	
	PROJECT LOCATION: 14062 N. 106th Way Scottsdale, AZ 85260	SCALE: NTS
SHEET NUMBER 3	CONTACT INFORMATION: Mike Fannin(602)-448-4460 mefannin@cox.net	DATE: 05/06/2024
DRAWN BY: KR		REVISED: N/A
This drawing represents visual concepts and construction suggestions based on industry standards. Nets Unlimited does not assume responsibility for damage caused by neglect or misuse, whether intentionally or unintentionally.		
<b>NETS</b> Unlimited, Inc. · 20625 N. 29TH PL. · PHOENIX, AZ 85050 (480)515-1300 · SALES@NETSUNLIMITED.COM		

**\*\*APPLICANT HAS STATED THAT THE PROTECTIVE NET HAS BEEN BROUGHT DOWN TO 20'-0" IN HEIGHT AT ALL LOCATIONS.\*\***



**PROPOSED STRUCTURE DETAILS:**

- 4" DIAMETER SCHEDULE 40 VERTICAL POSTS
- 1-5/8" DIAMETER SCHEDULE 27 HORIZONTAL RAILS
- HORIZONTAL RAILS CONNECTED TO VERTICAL POSTS WITH GALVANIZED STEEL CONNECTIVE HARDWARE
- 24" W x 48" D CONCRETE FOOTERS FOR VERTICAL POSTS
- STEEL SUPPORT STRUCTURE TO BE BLACK
- COMMERCIAL GRADE 7/8" MESH BLACK HIGH-TENACITY UV STABILIZED POLYESTER GOLF DETERRENT NETTING WITH BLACK 3/8" POLYPROPYLENE ROPE BORDER

 SHEET NUMBER  DRAWN BY: KR	<b>FANNIN RESIDENCE NEW NETTING</b>	
	PROJECT LOCATION: 14062 N. 106th Way Scottsdale, AZ 85260	SCALE: NTS
CONTACT INFORMATION: Mike Fannin(602)-448-4460 mefannin@cox.net	DATE: 05/06/2024	
This drawing represents visual concepts and construction suggestions based on industry standards. Nets Unlimited does not assume responsibility for damage caused by neglect or misuse, whether intentionally or unintentionally.		REVISED: N/A
NETS Unlimited, Inc. · 20625 N. 29TH PL. · PHOENIX, AZ 85050 (480)515-1300 · SALES@NETSUNLIMITED.COM		

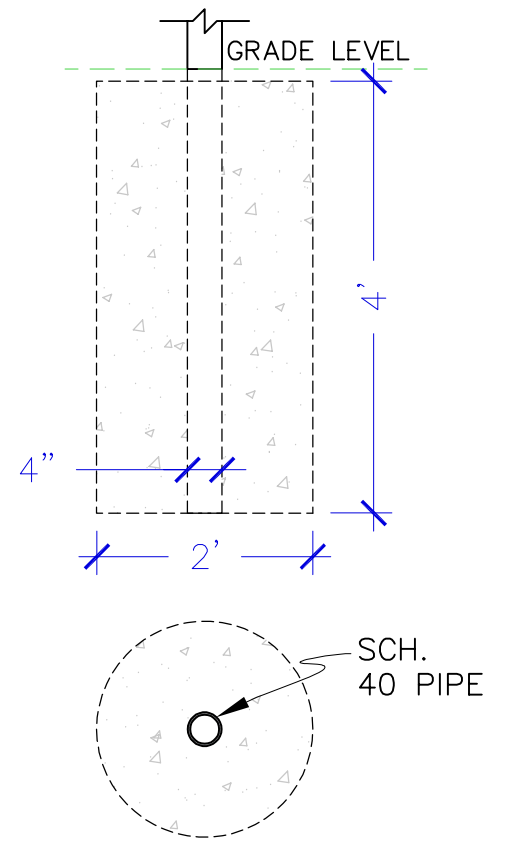
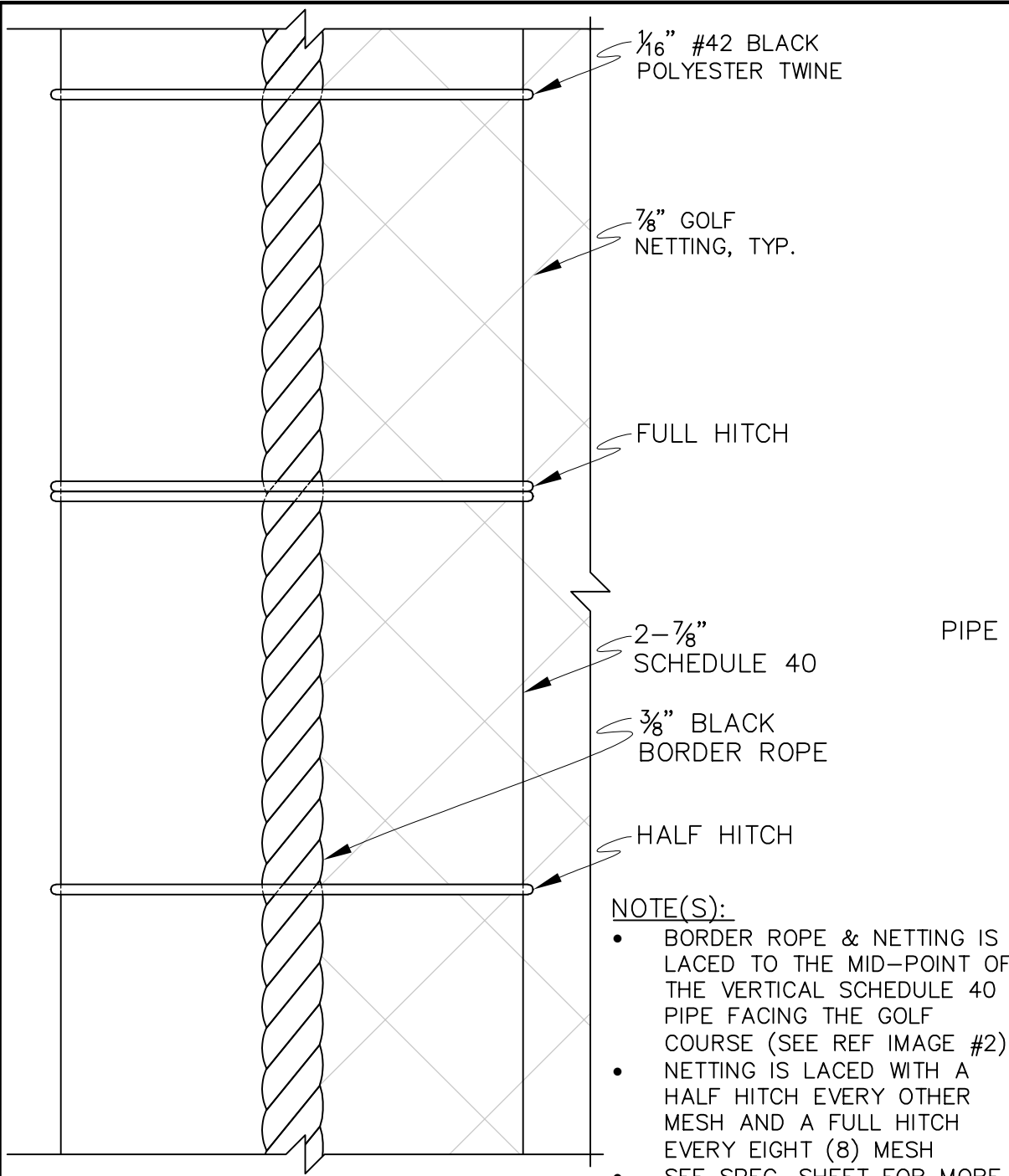

② CONC. FOOTER DETS.  
SCALE: 3/4" = 1'-0"

- NOTE(S):**
- BORDER ROPE & NETTING IS LACED TO THE MID-POINT OF THE VERTICAL SCHEDULE 40 PIPE FACING THE GOLF COURSE (SEE REF IMAGE #2)
  - NETTING IS LACED WITH A HALF HITCH EVERY OTHER MESH AND A FULL HITCH EVERY EIGHT (8) MESH
  - SEE SPEC. SHEET FOR MORE DETAILS

⑤ LACING DETAILS  
SCALE: FULL SCALE

 SHEET NUMBER <b>5</b> DRAWN BY: KR	<b>FANNIN RESIDENCE NEW NETTING</b>	
	PROJECT LOCATION: 14062 N. 106th Way Scottsdale, AZ 85260	SCALE: NTS
	CONTACT INFORMATION: Mike Fannin(602)-448-4460 mefannin@cox.net	DATE: 05/06/2024
	REVISED: N/A	
This drawing represents visual concepts and construction suggestions based on industry standards. Nets Unlimited does not assume responsibility for damage caused by neglect or misuse, whether intentionally or unintentionally. <b>NETS Unlimited, Inc.</b> · 20625 N. 29TH PL. PHOENIX, AZ 85050 (480)515-1300 · SALES@NETSUNLIMITED.COM		

# Tab D

November 06, 2024



Code Enforcement

**COMPLIANCE NOTICE**

FANNIN MICHAEL E/BONNIE K  
14062 N 106TH WY  
SCOTTSDALE, AZ 85259

**RE: Case# 378285 - 14062 N 106TH WY, SCOTTSDALE, AZ 85255 (APN: 217-65-618)**

This notice to comply is to inform you that on Wednesday, November 6, 2024, the property listed above was inspected and found to be in violation of the City of Scottsdale codes or Arizona Revised Statutes as listed on the attached pages. A re-inspection will be conducted on or after Thursday, December 5, 2024 to verify compliance. If the property is brought into compliance with the Code prior to the scheduled re-inspection date listed above, you will not be subject to citations or fines for the violation(s). This letter serves as a legal notice of violation (s) of the following subsection(s) of the Property Maintenance Ordinance - Chapter 18, Zoning Ordinance of the Scottsdale City Code or Arizona Revised Statutes.

**We appreciate your cooperation in this matter. If for any reason you have difficulty complying with the noted corrective actions listed on the attached page or need further information, please contact us by using any of the following methods below:**

- Call Code Inspector:** John Stumbaugh-reach directly at 480-312-3023(Office hours vary)
- Email Us:** Code@ScottsdaleAZ.gov
- Write Us:** 7447 E. Indian School Rd. Ste. 100, Scottsdale, AZ 85251
- Call Us:** Mon-Fri 8 AM - 5 PM at (480) 312-2546 or Fax (480) 312-2455
- Web Address:** <http://www.ScottsdaleAZ.gov/codes/code-enforcement>

**Please Note:** *Scottsdale Code Inspectors work varied hours and days each week at different locations other than our main address. You are encouraged to call us before visiting our office.*

For TTY users, have operator at the AZ Relay Services (711) call our number. This information is available in alternate format upon request. Thank you.

## VIOLATION DETAIL(S)

Please be advised that an investigation has shown that this property is in violation of the City Nuisance and Property Maintenance Ordinance or City Code in the following area(s):

Correct all violation(s) by: **Thursday, December 5, 2024**

---

**Violation Code:** 1.1101 - Building Permits Required

**Violation Description:**

Constructing, altering, repairing, removing or demolishing, or commencing construction, alteration, removal or demolition of a building or structure without a formal permit from the Zoning Administrator. Contact the City's Code Compliance Department at 480-312-3031, on line at <http://www.scottsdaleaz.gov/codes/code-enforcement>, or visit the One Stop Shop at 7447 E. Indian School Road for more information and to initiate the process to obtain required permits.

Note: Based on building and zoning code requirements, it may be determined that your construction is not allowed and must be removed.

**Corrective Action:**

A exterior fence was found constructed without the proper building permits. Please cease all construction until the proper building permits are acquired. Contact the One Stop Shop at 7447 E Indian School Rd. Suite 100, Scottsdale, AZ 85251. Thank you.

**Applicable in instances of non-compliance**

Civil and Criminal Penalties: Persistent or uncorrected violations may result in fines of up to \$2,500 for each day a violation is found, six (6) months in jail, probation, or any combination thereof. Property Maintenance Ordinance violations that are not corrected may be abated by a City hired contractor with an assessment against the property for the costs incurred. Recidivists (repeat offenders) may receive only ONE official Notice of Ordinance Violation.

# Tab E

# Protective Net Images

**Initial installation – 30 feet**



**Current installation – 20 feet**



# Protective Net Images

**Initial installation – 30 feet**



**Current installation – 20 feet**



# Protective Net Images

Current installation – 20 feet

View from 106th Way



# McDowell Mountain Ranch Community Association

16116 N McDowell Mountain Ranch Rd  
Scottsdale, AZ 85255

Phone: 480-473-0877

---

Michael E Fannin  
14062 N 106th Way  
Scottsdale, AZ 85255-1761

RE: Architectural Submittal for 14062 N 106th Way  
Account#: 1456430  
Submittal: Screen Enclosure Beyond Existing

June 13, 2024

Dear Michael E Fannin,

Your recent request to install a golf screen on the North and West side of your property has been reviewed and **APPROVED WITH STIPULATIONS**. The stipulations are outlined below:

**Proposal #2 has been approved - 30' for first 5 poles on most West side of property, 20' for remaining poles on East side of property. The existing trees shall be maintained for proper screening.**

This approval is subject to all County, City, State and Federal permits, codes, statutes, laws, rules, and regulations, which are the sole responsibility of the homeowner. This approval shall not be deemed a warranty or representation as to the quality of the construction, installation, addition, alteration, repair, change or other work.

Upon the completion of the approved project, please notify McDowell Mountain Ranch Community Association. Management reserves the right to inspect the completed work to ensure the project was completed as submitted.

Should you have any questions, please feel free to contact me at 480-473-0877 or by email at [crichardson@associatedasset.com](mailto:crichardson@associatedasset.com). We thank you for your patience with this process.

Sincerely,

Chris Richardson  
Community Manager  
For the Architectural Committee of  
McDowell Mountain Ranch Community Association



Context Aerial

4-BA-2025



Close-up Aerial

4-BA-2025



Q.S.  
33-53

Aerial

Zoning Aerial

4-BA-2025

# Existing Conditions Site Photos



# Existing Condition Site Photos

\*(Note: fence is at original 30 ft height in these pictures)



RESIDENCE  
BACKYARD



NOTE(S):

- STRUCTURE TO BE OFFSET FROM EXISTING FENCE BY 2'-0"
- NEW STRUCTURE TO BEGIN AT POLE #3 IN CURRENT POLE LOCATION ONCE REMOVED.

NET #	HEIGHT	LENGTH
2	20' -0"	49.5'
1	20' -0"	46' -0"
3	20' -0"	29' -0"

1 PLAN VIEW  
2 SCALE: NOT TO SCALE

ATTACHMENT 7

	<b>FANNIN RESIDENCE NEW NETTING</b>	
	PROJECT LOCATION: 14062 N. 106th Way Scottsdale, AZ 85260	SCALE: NTS
SHEET NUMBER <span style="font-size: 2em;">2</span>	CONTACT INFORMATION: Mike Fannin(602)-448-4460 mefannin@cox.net	DATE: 05/06/2024
	DRAWN BY: KR	REVISED: N/A
This drawing represents visual concepts and construction suggestions based on industry standards. Nets Unlimited does not assume responsibility for damage caused by neglect or misuse, whether intentionally or unintentionally.		
NETS Unlimited, Inc. · 20625 N. 29TH PL. · PHOENIX, AZ 85050 (480)515-1300 · SALES@NETSUNLIMITED.COM		

# City Notifications – Mailing List Selection Map

## The Fannin Residence Net

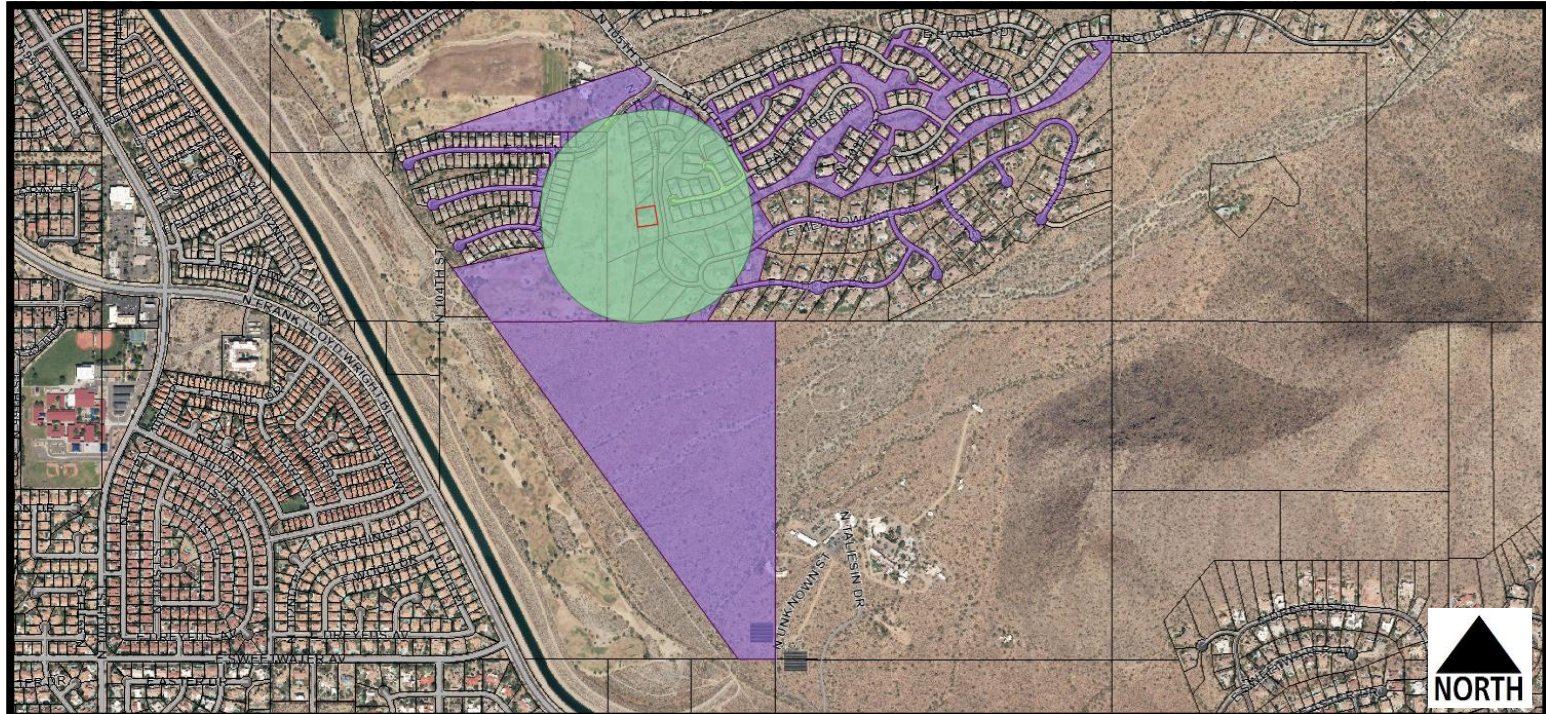

Labels pulled  
February 4, 2025

### Additional Notifications:

- Interested Parties List
- Adjacent HOA's
- P&Z E-Newsletter
- Facebook
- Nextdoor.com
- City Website-Projects in the hearing process

### Map Legend:

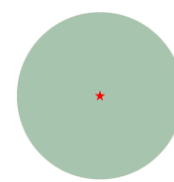
-  Site Boundary
-  Properties within 750-foot

Postcards: 89

**4-BA-2025**

**RE: application 4-BA-2025, 14062 N 106th Way**

---

**From** barb877@waston.me <barb877@waston.me>

**Date** Tue 2/18/2025 5:10 PM

**To** Morrison, Adam <AMorrison@Scottsdaleaz.gov>

**⚠External Email: Please use caution if opening links or attachments!**

Dear City of Scottsdale Board of Adjustment:

As neighbors of Fannin's, we are writing to express our support for the variance being requested via application 4-BA-2025 for the property at 14062 N. 106<sup>th</sup> Way. The proposed golf ball protection net is clearly needed to help protect this property, its residents and also our property. We can verify he is still getting golf balls in his backyard. We realize the Fannin's efforts to date are most likely also helping reduce the number of golf balls that come into our yard and hopefully the taller fence will protect our northern windows, as well. We have had broken windows before. Golf balls fly off of this course often and can be a great danger and destroyer of property. We constantly are repairing holes in our stucco from errant golf balls hitting our home.

We would request that you please approve this request.

Sincerely,

Tom and Barb Wassenberg

14020 N 106<sup>th</sup> Way

City of Scottsdale Board of Adjustment Member:

As someone who lives nearby, I am writing to express my full support for Case # 4-BA-2025 for the Fannin residence. Golf balls fly off of this course often and be a great danger, or at best, a nuisance. This is a reasonable request to protect their home.

This application has our full support. Please approve!

Thank you!

Karyn Thomas

McDowell Mountain Ranch resident

Dear Board of Adjustment:

I am writing to express my wholehearted support for the variance being requested via application 4-BA-2025 for the property at 14062 N. 106<sup>th</sup> Way. The proposed golf ball protection net is clearly needed to help protect this property and its residents. We greatly appreciate the Fannins' efforts to date.

Please approve this request.

Sincerely,  
Mark Thomas  
McDowell Mountain Ranch Resident

## Kelly, John

---

**From:** WebServices  
**Sent:** Tuesday, March 4, 2025 5:43 PM  
**To:** Board Of Adjustment; Projectinput  
**Subject:** Board of Adjustment Public Comment

**Importance:** High

**Categories:** Jack

**Name:** Maurice Khoury

**Address:** 11051 e meadowhill dr, Scottsdale, AZ 85255

**Email:** mokhuory1@gmail.com

**Phone:** (480) 326-1404

### **Comment:**

**1. Golf Course Changes Please provide more specific information as to how the golf course has recently been modified. Maps pulled going back as far as 2000 show no significant change if any at all through 2025. We have also provided images below showing the golf course when the homes were constructed through current. 2025 Map / 2000 Map (Side by Side) The only notable change on this hole appears to be the widening of the fairway west, which would better this situation. The vourse to the east cannot be modified as described as it has the cart path, so there is nothing as described as recent modifications that would impact this lot as mentioned. Beyond this we see no modifications to the course. Note the cart path is in same position, as well as tee boxes, sand traps, and green. The tee offs historically through now will all land in the same position and is only dependent on the golfer's skill level. 2. Additional Trees Added The trees are all dead along the north wall where changes are mentioned. They appear to not be properly maintained, have died at some point, and/or are no longer able to grow due to improper care. Their height appears to be stunted at around 15 ft. On the other hand, the tree in the front yard has grown taller than the 20 ft fence itself. Perhaps around 25 ft, so this is easily achievable. Had proper care for plants been maintained throughout the years the trees achieved the same results as the proposed solution by homeowner while still adhering to community standards. 3. Golf Course Correspondence How has the golf course proposed to resolve this issue? Please provide all correspondence with their facility and resolution proposals they have offered. If any issue does exist most certainly you have already attempted to resolve this with their organization? 4. Fence Paint Conformance The current black fencing does not appear to conform to fencing guidelines for color in the community. 5. Other Homes Situated on Course It's mentioned that this house is in an undesirable position and located midcourse. However, it should be noted that several homes are located within the same geographical area and have not had any such request for fencing. Many of the homes in the community surrounding the course have changed hands over the past 25 years since this home's construction. It seems that all of the current or previous homeowners were well aware of the nature of living on a golf course and the nature of errant golf balls. Additionally, these other homes appear to have landscaped backyards so the occupants would have enjoyed those backyards in comfort and without mentioned fears during their time at those residences over the span of 25 years. The homes mentioned appear to have utilized those backyards as it can clearly be seen from an overhead view they had pools, patios, barbeques and so on. All have done so with no fear for their**

safety without any of these encumbrances mentioned. This backyard appears to be unfinished. 6. Impact Analysis Study Firm Statement That authorization of the variance will not be materially detrimental to persons residing or working in the vicinity, to adjacent property, to the neighborhood or to the public welfare in general Has the firm performed an impact study it can provide for the following:

- The effects of golf course nets on property value for surrounding homes.
- The potential negative effects to avian wildlife in the area McDowell Mountain Ranch is known for its diverse and rich wildlife throughout the preserve and an impact study should be delivered to ensure the safety of these animals not being captured in a 20 ft netted structure.

**FINAL COMMUNITY EVALUATION** In light of all of the efforts, members of the community feel that the residence did not exhaust all other means of relief. In addition they have not provided sufficient impact studies to make an informed decision as it would relate to the surrounding property values, community, and wildlife. It appears that had the city not taken action this structure would have simply remained in violation of city regulations with no regard for community standards, this is simply disappointing. The firm representing this case also makes claims such as golf course changes, but then shows no actual changes which therefore no informed decisions can be rendered. Overall, it is the opinion based on what has been delivered that this should not be approved. There are no means to delivery satisfactory results that fall within the guidelines of the city and community standards. Any previous efforts were stalled, never tried, or simply not provided in these documents for community members to make a final decision in this matter that would provide sufficient alternative means. It should also be noted that the residence in MMR in all cases we have seen historically would have been directed by the HOA to get city approval. This would have been done so by the HOA and records of this surely would exist. If the resident simply ignored this with the expectation of hoping no one would notice this adds another layer of circumvention to the process.

## Kelly, John

---

**From:** WebServices  
**Sent:** Tuesday, March 4, 2025 5:40 PM  
**To:** Board Of Adjustment; Projectinput  
**Subject:** Board of Adjustment Public Comment

**Importance:** High

**Categories:** Jack

**Name:** Daniel Kosak  
**Address:** 10958 E Meadowhill Drive  
**Email:** dankosak21@gmail.com  
**Phone:** (602) 999-9796

### **Comment:**

**1. Golf Course Changes** Please provide more specific information as to how the golf course has recently been modified. Maps pulled going back as far as 2000 show no significant change if any at all through 2025. We have also provided images below showing the golf course when the homes were constructed through current. **2025 Map / 2000 Map (Side by Side)** The only notable change on this hole appears to be the widening of the fairway west, which would better this situation. The vourse to the east cannot be modified as described as it has the cart path, so there is nothing as described as recent modifications that would impact this lot as mentioned. Beyond this we see no modifications to the course. Note the cart path is in same position, as well as tee boxes, sand traps, and green. The tee offs historically through now will all land in the same position and is only dependent on the golfer's skill level. **2. Additional Trees Added** The trees are all dead along the north wall where changes are mentioned. They appear to not be properly maintained, have died at some point, and/or are no longer able to grow due to improper care. Their height appears to be stunted at around 15 ft. On the other hand, the tree in the front yard has grown taller than the 20 ft fence itself. Perhaps around 25 ft, so this is easily achievable. Had proper care for plants been maintained throughout the years the trees achieved the same results as the proposed solution by homeowner while still adhering to community standards. **3. Golf Course Correspondence** How has the golf course proposed to resolve this issue? Please provide all correspondence with their facility and resolution proposals they have offered. If any issue does exist most certainly you have already attempted to resolve this with their organization? **4. Fence Paint Conformance** The current black fencing does not appear to conform to fencing guidelines for color in the community. **5. Other Homes Situated on Course** It's mentioned that this house is in an undesirable position and located midcourse. However, it should be noted that several homes are located within the same geographical area and have not had any such request for fencing. Many of the homes in the community surrounding the course have changed hands over the past 25 years since this home's construction. It seems that all of the current or previous homeowners were well aware of the nature of living on a golf course and the nature of errant golf balls. Additionally, these other homes appear to have landscaped backyards so the occupants would have enjoyed those backyards in comfort and without mentioned fears during their time at those residences over the span of 25 years. The homes mentioned appear to have utilized those backyards as it can clearly be seen from an overhead view they had pools, patios, barbeques and so on. All have done so with no fear for their

safety without any of these encumbrances mentioned. This backyard appears to be unfinished. 6. Impact Analysis Study Firm Statement That authorization of the variance will not be materially detrimental to persons residing or working in the vicinity, to adjacent property, to the neighborhood or to the public welfare in general Has the firm performed an impact study it can provide for the following:

- The effects of golf course nets on property value for surrounding homes.
- The potential negative effects to avian wildlife in the area McDowell Mountain Ranch is known for its diverse and rich wildlife throughout the preserve and an impact study should be delivered to ensure the safety of these animals not being captured in a 20 ft netted structure.

**FINAL COMMUNITY EVALUATION** In light of all of the efforts, members of the community feel that the residence did not exhaust all other means of relief. In addition they have not provided sufficient impact studies to make an informed decision as it would relate to the surrounding property values, community, and wildlife. It appears that had the city not taken action this structure would have simply remained in violation of city regulations with no regard for community standards, this is simply disappointing. The firm representing this case also makes claims such as golf course changes, but then shows no actual changes which therefore no informed decisions can be rendered. Overall, it is the opinion based on what has been delivered that this should not be approved. There are no means to delivery satisfactory results that fall within the guidelines of the city and community standards. Any previous efforts were stalled, never tried, or simply not provided in these documents for community members to make a final decision in this matter that would provide sufficient alternative means. It should also be noted that the residence in MMR in all cases we have seen historically would have been directed by the HOA to get city approval. This would have been done so by the HOA and records of this surely would exist. If the resident simply ignored this with the expectation of hoping no one would notice this adds another layer of circumvention to the process.

## Cluff, Bryan

---

**From:** Dan Kosak <dankosak21@gmail.com>  
**Sent:** Tuesday, March 4, 2025 5:29 PM  
**To:** Perreault, Erin; Curtis, Tim; Cluff, Bryan; Morrison, Adam  
**Cc:** mokhoury1@gmail.com  
**Subject:** The Fannin Residence Net 4-BA-2025 Request - 14062 N 106th Way  
**Attachments:** Golf Course Changes (Final).pdf

**⚠ External Email: Please use caution if opening links or attachments!**

We are submitting comments online as many people have similar comments. Most were unaware of where to submit a more detailed outline and comment. We have two signatures listed but there are 4 to 5 other community members who did not understand submittal and timeline requirements but otherwise would have submitted their disapproval. We have simply run out of time per your guidelines. We can also submit partials online if that helps.

Thanks,  
Dan

**STAFF NOTE: ATTACHMENT PROVIDED  
ON FOLLOWING PAGES.**

STAFF NOTE: THE FOLLOWING 8 PAGES  
SUBMITTED BY DAN KOSAK 3/4/2025

## **BOARD OF ADJUSTMENT REPORT**

Meeting Date: 3/5/2025

### **ACTION**

The Fannin Residence Net  
4-BA-2025

### **COMMUNITY RESPONSE/COMMENTS**

## 1. Golf Course Changes

Please provide more specific information as to how the golf course has recently been modified. Maps pulled going back as far as 2000 show no significant change if any at all through 2025. We have also provided images below showing the golf course when the homes were constructed through current.

### 2025 Map / 2000 Map (Side by Side)

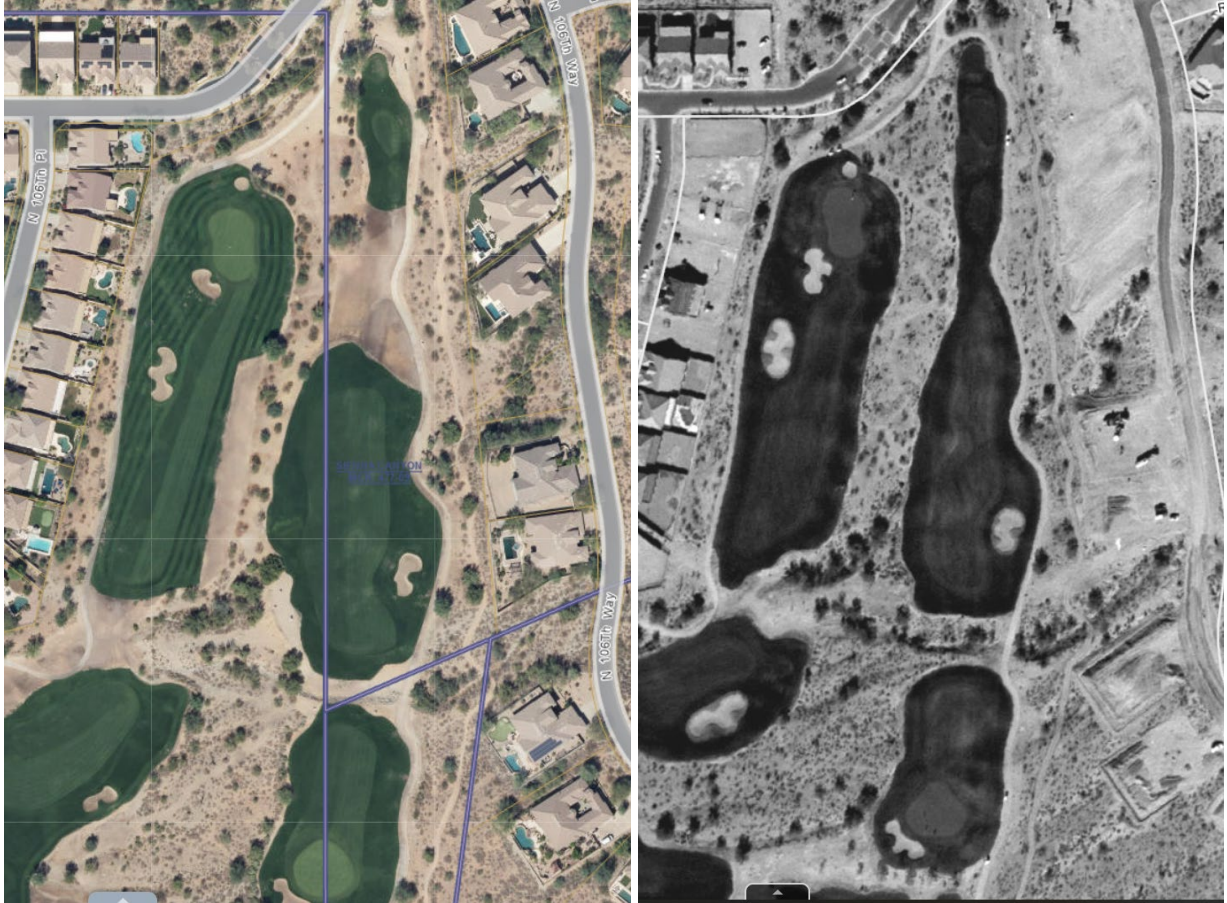

The only notable change on this hole appears to be the widening of the fairway west, which would better this situation. The vourse to the east cannot be modified as described as it has the cart path, so there is nothing as described as recent modifications that would impact this lot as mentioned.

Beyond this we see no modifications to the course. Note the cart path is in same position, as well as tee boxes, sand traps, and green. The tee offs historically through now will all land in the same position and is only dependent on the golfer's skill level.

**Overlay**

This maps overlay shows exactly the noted comments from above.



## 2. Additional Trees Added

The trees are all dead along the north wall where changes are mentioned. They appear to not be properly maintained, have died at some point, and/or are no longer able to grow due to improper care. Their height appears to be stunted at around 15 ft.

On the other hand, the tree in the front yard has grown taller than the 20 ft fence itself. Perhaps around 25 ft, so this is easily achievable. Had proper care for plants been maintained throughout the years the trees achieved the same results as the proposed solution by homeowner while still adhering to community standards.



## 3. Golf Course Correspondence

How has the golf course proposed to resolve this issue? Please provide all correspondence with their facility and resolution proposals they have offered. If any issue does exist most certainly you have already attempted to resolve this with their organization?

#### 4. Fence Paint Conformance

The current black fencing does not appear to conform to fencing guidelines for color in the community.

#### 5. Other Homes Situated on Course

It's mentioned that this house is in an undesirable position and located midcourse. However, it should be noted that several homes are located within the same geographical area and have not had any such request for fencing.

Many of the homes in the community surrounding the course have changed hands over the past 25 years since this home's construction. It seems that all of the current or previous homeowners were well aware of the nature of living on a golf course and the nature of errant golf balls.



Additionally, these other homes appear to have landscaped backyards so the occupants would have enjoyed those backyards in comfort and without mentioned fears during their time at those residences over the span of 25 years.

The homes mentioned appear to have utilized those backyards as it can clearly be seen from an overhead view they had pools, patios, barbeques and so on.

All have done so with no fear for their safety without any of these encumbrances mentioned. This backyard appears to be unfinished.



## 6. Impact Analysis Study

### *Firm Statement*

***That authorization of the variance will not be materially detrimental to persons residing or working in the vicinity, to adjacent property, to the neighborhood or to the public welfare in general***

Has the firm performed an impact study it can provide for the following:

- The effects of golf course nets on property value for surrounding homes.
- The potential negative effects to avian wildlife in the area

McDowell Mountain Ranch is known for its diverse and rich wildlife throughout the preserve and an impact study should be delivered to ensure the safety of these animals not being captured in a 20 ft netted structure.

## FINAL COMMUNITY EVALUATION

In light of all of the efforts, members of the community feel that the residence did not exhaust all other means of relief. In addition they have not provided sufficient impact studies to make an informed decision as it would relate to the surrounding property values, community, and wildlife.

It appears that had the city not taken action this structure would have simply remained in violation of city regulations with no regard for community standards, this is simply disappointing. The firm representing this case also makes claims such as golf course changes, but then shows no actual changes which therefore no informed decisions can be rendered.

Overall, it is the opinion based on what has been delivered that this should not be approved. There are no means to delivery satisfactory results that fall within the guidelines of the city and community standards. Any previous efforts were stalled, never tried, or simply not provided in these documents for community members to make a final decision in this matter that would provide sufficient alternative means.

**It should also be noted that the residence in MMR in all cases we have seen historically would have been directed by the HOA to get city approval. This would have been done so by the HOA and records of this surely would exist. If the resident simply ignored this with the expectation of hoping no one would notice this adds another layer of circumvention to the process.**

# COMMUNITY SIGNATURES

10958 E. Meadowhill Dr.

Address

Daniel Kosak

Full Name

dankosak21@gmail.com

Email or Phone

3.4.25

Date

11051 E Meadowhill Dr

Address

Maurice Khoury

Full Name

mokhoury1@gmail.com

Email or Phone

03-04-2025

Date

Address

Full Name

Email or Phone

Date

Address

Full Name

Email or Phone

Date

Address

Full Name

Email or Phone

Date

Address

Full Name

Email or Phone

Date

Scottsdale City Officials please note this document contains personal information and should be handled as such. All information deemed under local, state, and federal as personal should be handled in accordance with those laws.

**Kelly, John**

---

**From:** K. Craig Kent <kcraigkent@gmail.com>  
**Sent:** Tuesday, March 4, 2025 3:29 PM  
**To:** Kelly, John  
**Subject:** Case # 4-BA-2025

⚠ External Email: Please use caution if opening links or attachments!

Good afternoon,

We are writing to express our opinion on Case # 4-BA-2025 and the request to allow a variance to erect a 20 foot tall fence in the rear of this property.

We do not want this variance to be granted as the fence would be in the direct line of vision of our backyard and would obstruct and ruin the beautiful views of the mountains and countryside behind us. We spend all of our time in the back rooms of the home as well as the rear outdoor area, so placing this fence would greatly impact our quality of life as well as the value of our property.

All of us that live in Sonoran Estates do so because of its beauty and we don't think anyone would want to take away from that beauty. We are certain if this is allowed that others will follow and that side of Sonoran Estates will end up being one large visible fence. We can't even imagine. It is the views from our back yard that led us to purchase our house and it would be devastating for this to be the outcome.

Please feel free to reach out and we are very willing to share our views. Sorry we can't be there for the meeting.

Sincerely yours,

Craig and Marjorie Kent  
The K Craig Kent Exempt Family Trust  
10685 East Redfield Road  
Scottsdale AZ

917-414-5230

## Kelly, John

---

**From:** Morrison, Adam  
**Sent:** Tuesday, March 4, 2025 1:22 PM  
**To:** Kelly, John  
**Subject:** Fw: Golf netting

Hi Jack,

I just received this public comment for 4-BA-2025, thank you.



**PLANNING & DEVELOPMENT**  
**Adam Morrison | Associate Planner**  
7447 E. Indian School Rd, Ste 105  
Scottsdale, AZ 85251

---

**From:** Anthony Herrmann <Anthony.Herrmann@earnhardt.com>  
**Sent:** Tuesday, March 4, 2025 12:21 PM  
**To:** Morrison, Adam <AMorrison@Scottsdaleaz.gov>  
**Cc:** mefannin@cox.net <mefannin@cox.net>  
**Subject:** Golf netting

**⚠ External Email: Please use caution if opening links or attachments!**

As a fellow McDowell Mountain Ranch resident, I support the Mike and Bonnie Fannin request for a golf net on their property (case#4-bas-2025). Nothing like someone yelling "INCOMING!" and having to dive for cover. It seems like a reasonable request.

Sincerely,  
Anthony Herrmann

**From:** [WebServices](#)  
**To:** [Board Of Adjustment](#); [Projectinput](#)  
**Subject:** Board of Adjustment Public Comment  
**Date:** Monday, March 3, 2025 9:52:04 PM  
**Importance:** High

---

**Name:** Robert Willittes  
**Address:** 10670 E. Palm Ridge Dr, Scottsdale, A 85255  
**Email:** [bcwillittes@gmail.com](mailto:bcwillittes@gmail.com)  
**Phone:**

**Comment:**

**For Case Number: 4-BA-2025 Please do not approve this huge fence in such a sensitive area. Neighbors are frustrated this is even being considered but clearly the Attorney's are trying to bend the rules. This huge fence negatively impacts the people in the community, the views, the aesthetics, and the general feel of the surroundings. Additionally, this property is not unique for a golf course property. Summarizing: This case should be denied because the four criteria are not met and also because of the negative impacts to the community.**

## Kelly, John

---

**From:** NoReply  
**Sent:** Monday, March 3, 2025 1:35 PM  
**To:** Projectinput  
**Subject:** Variance to raise fence to 20 feet

**Categories:** Jack



This fence will be in my backyard view. I do not want a fence that goes above the height of the house. -- sent by Karen Kelley (case# 4-BA-2025)



© 2025 City of Scottsdale. All Rights Reserved.