



Expires 12/31/2023

May 31, 2022

Mr. Christopher Brown, FASLA, LEED AP, SITES AP
Floor Associates
1425 North 1st Street, Suite 200
Phoenix, Arizona 85004

RE: TRAFFIC IMPACT STATEMENT FOR A PARK WITH PICKLEBALL AND BASKETBALL COURTS, ASHLER HILLS DRIVE AT 74TH WAY – PHOENIX, SCOTTSDALE

Dear Mr. Brown:

Thank you for retaining CivTech to provide a traffic impact statement (TIS) for Floor Associates (the “**Client**”) for the park development, consisting of pickleball courts, a basketball court, picnic ramadas, and trails with 70 parking spaces located at Ashler Hills Drive at 74th Way in the City of Scottsdale, Arizona. There will be one (1) proposed site access at the roundabout at 74th Way and Ashler Hills Drive. A vicinity map of the site is shown in **Figure 1**. This statement is in response to the City of Scottsdale’s 1st Submittal comments. Comments and responses are provided in **Attachment A**. An attachment of the site plan is provided in **Attachment B**.



Figure 1 – Vicinity Map

BACKGROUND AND PURPOSE

The access will be located at the roundabout at 74th Way and Ashler Hills Drive. During the construction of the Project, the existing roundabout/traffic circle will be removed. In addition, an eastbound left turn lane will be added and the existing bike lane will be extended to the proposed entrance. The design of the site driveway and side walk across the driveway should be designed Per the City of Scottsdale *Standard Detail Drawings*, revised in 2020 based on the following details: COS Driveway Type CL-1, DSPM 5-3.200, and DSPM Sec. 5-3.205. The City's details are also provided in **Attachment C**. The site will provide approximately 70 parking spaces to accommodate the park.

The park will consist of approximately 8 pickleball courts, 1 basketball court, and a general park area. CivTech estimated the acreages of the general park area to be approximately 6.8-acres. CivTech is aware that only a portion of the 6.8-acres will be utilized as a general park; but to be conservative, it was assumed that the general will be the entire 6.8-acres.

This TIS is part of Floor Associates' application to the City requesting a rezoning of the project site. The purpose of this statement is to document the expected number of daily and peak hour trips generated by the site and analyze the adjacent signalized intersection.

EXISTING TRAFFIC CONDITIONS

Scottsdale Road is a north-south minor arterial roadway classified by the City of Scottsdale's *Functional Classification Map*. The roadway is a four (4) lane divided roadway with two (2) travel lanes and a bike lane in each direction and a center 29-foot raised median. Scottsdale Road begins to the north at Carefree Highway extending south to transition into Drinkwater Boulevard just south of Camelback Road. The posted speed limit is 50 miles per hour (mph) within the vicinity of the site.

Ashler Hills Drive is an east-west non-classified roadway. The roadway is mainly a two (2) lane roadway with one (1) lane in each travel direction. Between Scottsdale Road and the roundabout to the east, Ashler Hills Drive provides one (1) eastbound lane, two (2) westbound lanes, a bike lane in each direction, and a center 13-foot raised median. Ashler Hills Drive begins to the west at 68th Street extending east to become 74th Way at the roundabout. The posted speed limit is 25 mph within vicinity of the site.

The intersection of **Scottsdale Road and Ashler Hills Drive** operates as a signalized intersection with protected-permitted left turn phasing in the northbound, eastbound, and westbound approaches and protected left turn phasing in the southbound approach. The northbound and southbound approaches are striped to consist of an exclusive left turn lane, two (2) through lanes, a bike lane, and an exclusive right turn lane. The eastbound approach is striped to consists of an exclusive left turn lane, a shared through/right-turn lane, and a bike lane. The westbound approach is striped to consists of an exclusive left turn lane, one (1) through lane, a bike lane, and an exclusive right turn lane. A designated pedestrian crosswalk is provided at each leg of the intersection.

CivTech engaged Field Data Services of Arizona, Inc. on Wednesday, April 14, 2021 peak hour volume turning movement counts were performed from 7:00-9:00 AM and 4:00-6:00 PM and Saturday, April 17, 2021 peak hour volume turning movement counts were performed from 7:00-9:00 AM and 11:00 AM-1:00 PM at Scottsdale Road and Ashler Hills Drive for this project. CivTech also engaged in All

Traffic Data for 24-hour approach counts on Ashler Hills Drive between 73rd Street and the roundabout on Thursday, March 17, 2022.

CivTech took historical daily traffic volumes from the City of Scottsdale website Daily Traffic Volume Map to estimate an average annual growth rate. Average daily traffic volumes on Scottsdale Road between Ashler Hills Drive and Dove Valley Road were considered. The location experienced an average annual increase of 0.7% per year from 2016 to 2018. To be conservative a 1% annual growth rate (1.010 annual expansion factor for the 2022 year) was applied to the 2021 turning movement counts at the intersection of Scottsdale Road and Ashler Hills Drive to obtain 2022 existing traffic volumes. CivTech utilized the 2022 24-hour counts to obtain the AM and PM peak hour through volumes at 74th Way and Existing Driveway located just east of the roundabout. By doing so, the volumes separate the commercial trips from the residential trips traveling along 74th Way.

Saturday peak hour counts at 74th Way and Existing Driveway were not conducted. To obtain the Saturday volumes at 74th Way and Existing Driveway, CivTech compared the PM with Saturday peak hour ins/outs traffic volumes at the east leg of the intersection of Scottsdale Road and Ashler Hills Drive. The results indicate that the eastbound approach (heading northbound on 74th Way) calculated a factor of 1.40 and the westbound (heading southbound on 74th Way) calculated a factor of 0.97 when comparing the PM and Saturday peak hour ins/outs at the east leg of the Scottsdale Road and Ashler Hills Drive. Therefore, the factor was applied to the existing PM peak hour at 74th Way and Existing Driveway to obtain the Saturday peak hour volumes along 74th Way.

The existing traffic volumes observed for this study intersections are presented in **Figure 2** for the typical weekday AM, PM, and Saturday peak hours. Traffic volume counts are provided in **Attachment D**.

Figure 2 – Existing Peak Hour Traffic Volumes

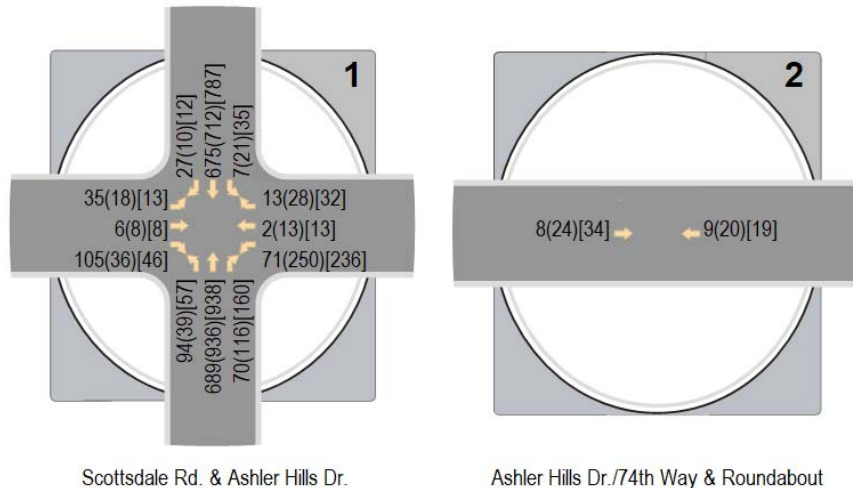

TRIP GENERATION

The potential trip generation for the proposed development was estimated utilizing the Institute of Transportation Engineers (ITE) *Trip Generation Manual, 11th Edition* and *Trip Generation Handbook, 3^d Edition*. The ITE *Trip Generation Manual* contains data collected by various transportation professionals for a wide range of different land uses. The data are summarized in the report and average rates and equations have been established that correlate the relationship between an independent variable that describes the development size and generated trips for each categorized land use. The report provides information for daily and peak hour trips.

ITE *Trip Generation Manual* does not provide trip generation rates for the specific land uses like pickleball court and basketball court. Since a pickleball court highly similar to a tennis court in terms of number of players, it was assumed that the pickleball courts will utilize the tennis court for PM Peak hour trip generation rates. For the AM peak hour, CivTech conducted a survey from 7:00 AM – 9:00 AM of vehicle counts utilizing the basketball court and pickleball courts during on Monday, March 21, 2022 at the Thompson Peak Park located on west of Hayden Road south of Thompson Peak Parkway in Scottsdale, Arizona. The park consists of 3 pickleball courts next to 1 basketball court. Based on the observations there were zero basketball users; at approximately 7:45 AM, the basketball court was converted into three additional pickleball courts. Therefore, the rates derived were based on 6 pickleball courts being counted on the field. The highest peak hour based on the observations were between 8:00 – 9:00 AM. The observation verifies that a total of 35 trips were made during the AM peak hour with 28 inbound trips and 7 outbound trips. With 35 total trips and 6 pickleball courts, results in an AM peak hour rate of 5.83. It should be noted that not all the players were playing at the same time. There were some people that stood by and waited for their turn to play. Thus, this concluded that the 5.83 would be maximum rate for the pickleball court. To be conservative, the Saturday peak hour for the pickleball courts is assumed to be the same as the AM peak hour.

CivTech prepared the recently approved Traffic Impact Analysis (TIA) for the Legacy Sports Family Entertainment Park in Mesa, Arizona. The park utilized the tennis court trip generation rates to derive trip generation rates for the basketball court. The ratio between the maximum number of players for a basketball game and for a tennis game is 10 to 4. Therefore, a multiple of 2.5(= $\frac{10}{4}$) were applied to the tennis court to estimate the basketball court land use for total daily, AM, PM, and Saturday peak hour. Based on the field data stated above, there were zero trips observed for the basketball court. Therefore, the basketball court AM peak hour rate will remain zero.

The anticipated trip generation is summarized in **Table 1**. Detailed trip generation calculations along with the field data observations are provided in **Attachment E**.

Table 1 – Trip Generation

Land Use	ITE Code	ITE Land Use Name	Quantity Units*		AM Distribution		PM Distribution		SAT Distribution					
					In	Out	In	Out	In	Out				
Park	411	Public Park	6.80	Acres	59%	41%	55%	45%	55%	45%				
Pickleball Courts	490	Tennis Courts	8	Courts	80%	20%	50%	50%	80%	20%				
Basketball Court	490	Tennis Courts	1	Courts	-	-	50%	50%	50%	50%				
ADT and Peak Hour Trips														
Land Use	ADT		AM Peak Hour			PM Peak Hour			Sat Peak Hour					
	Rates	Total	Rate	In	Out	Total	Rate	In	Out	Total	Rate	In	Out	Total
Park	13.65	92	0.02	0	0	0	0.11	1	0	1	0.28	1	1	2
Pickleball Courts	30.32	242	5.83	38	9	47	4.21	17	17	34	5.83	38	9	47
Basketball Court	75.80	76	-	0	0	0	10.53	6	5	11	6.63	4	3	7
Total		410		0	0	0		24	22	46		43	13	56

The proposed development is anticipated to generate 410 weekday daily trips, 47 trips during the typical weekday AM peak hour, 46 trips during the typical weekday PM peak hour, and 56 trips during the Saturday peak hour.

TRIP DISTRIBUTION AND ASSIGNMENT

A single trip distribution pattern was used in order to develop site generated traffic for the new proposed park. The trip distribution assumptions were made based on the surrounding residential area. It was assumed that the park will attract majority of the trips from north and south of Scottsdale Road and a small percentage will be on Ashler Hills Drive and 74th Way. The trip distribution percentages used for this analysis are shown in **Table 4**.

Table 2 – Trip Distribution Percentages

Roadway	Directions (to/from)	Distribution Percentages
Scottsdale Road	North	55%
Scottsdale Road	South	40%
Ashler Hills Drive	West	3%
74 th Way	North	2%
Total		100%

Figure 3 illustrates the trip distribution percentages shown in **Table 2** along the roadway network within the study area. The percentages presented in **Table 2** were applied to the site trips generated to determine the weekday AM, PM, and Saturday peak hour site traffic at the intersections within the study area. **Figure 3** illustrates the resulting site generated traffic for the proposed development.

Figure 3 – Site Generated Traffic Volumes

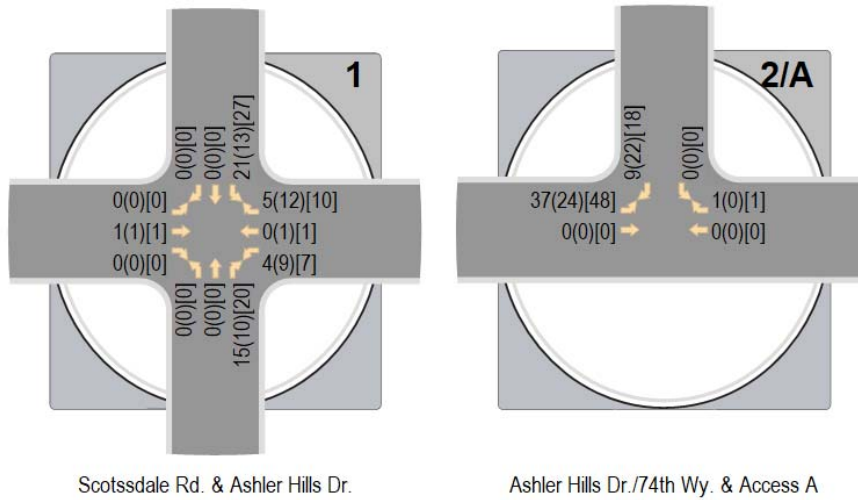

2022 SURROUNDING DEVELOPMENT TRAFFIC VOLUMES

East of the site is an undeveloped vacant land. The parcel is proposed to be 101 townhomes in the future with two (2) accesses, one (1) at the existing driveway and one (1) driveway on 74th Way. To be conservative, CivTech considered the east development to be open by the time the Park is open and generated trips using the ITE *11th Edition* trip generation rates for LUC 215. For the Saturday peak hour assumptions, CivTech applied the ITE’s Saturday peak hour of generator rates. The resulting trip generation indicated that the east development is anticipated to generate 720 weekday daily trips, with 47 trips (15 in/32 out) during the AM peak hour, 57 trips (32 in/25 out) during the PM peak hour, and 58 trips (28 in/30 out) during the Saturday peak hour. A single trip distribution pattern was provided for the development. Based on the Google Earth Pro aerial, there are multiple commercial developments are to the north of Ashler Hills Drive. Therefore, it was assumed that 63% of the trip distribution will be on Scottsdale Road north of Ashler Hills Drive. With the Loop 101 Freeway located approximately 8.41 miles to the south, a 35% trip distribution was assumed to be on Scottsdale Road south of Ashler Hills Drive to represent vehicles traveling long distances to/from work. The remaining 2% was assumed to be on Ashler Hills Drive west of Scottsdale Road to consider the cut through traffic that are heading to/from the schools located to the northwest. **Figure 4** illustrates the resulting site generated traffic for the east development at the study intersections. Trip generation calculations for the east development is provided in **Attachment F**.

Figure 4 – East Development Site Generated Traffic Volumes

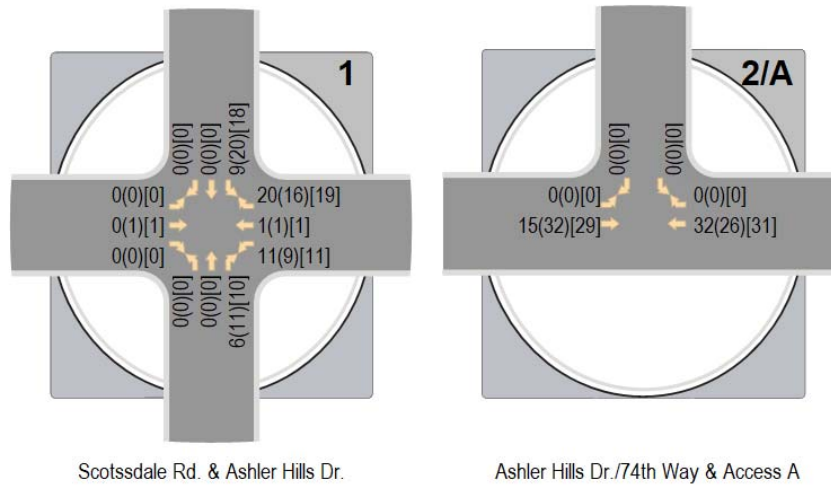

2022 TOTAL TRAFFIC VOLUMES

2022 total traffic volumes at the site access and the main intersection of Scottsdale Road and Ashler Hills Drive were determined by adding the proposed site generated traffic volumes and east development site generated traffic volumes to the existing traffic counts. **Figure 5** illustrates the resulting 2022 total traffic at the study intersections. Based on the highest peak hour generating less than 50 trips during the AM peak hour and only 56 trips estimated for the Saturday peak hour it was assumed that 70 parking spaces would be sufficient for the park.

Figure 5 – 2022 Total Traffic Volumes

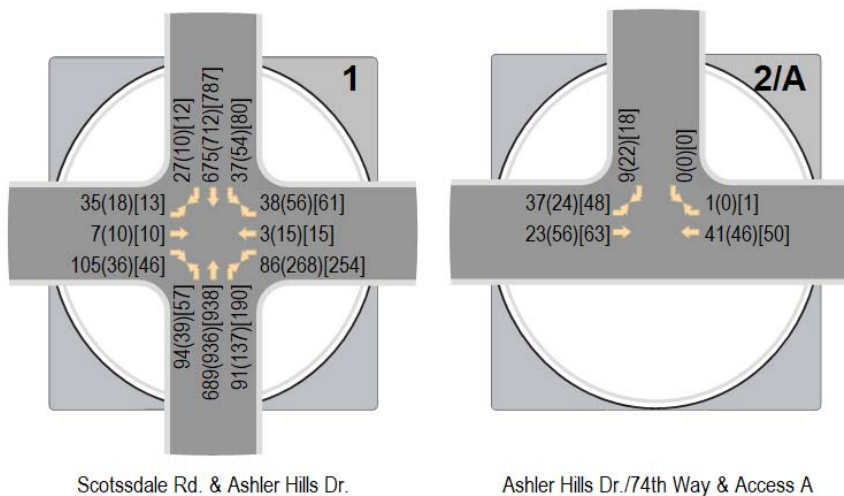

24-HOUR DAILY TRIPS

The 24-hour bi-directional counts conducted along Ashler Hills Drive determined that there are approximately 521 total daily trips (269 eastbound approach and 252 westbound approach). The site generated weekday daily total will add only 410 trips and the east development site generated weekday daily total is projected to add 720 trips onto Ashler Hills Drive projecting the average daily to 1,643 total daily trips. The 2022 average daily total for a weekday traffic volume is shown in **Figure 6.**



Figure 6 – 2022 Average Daily Total Traffic Volumes with Site & East Development Traffic

TRAFFIC IMPROVEMENT AND ANALYSIS

CAPACITY ANALYSIS

The concept of level of service (LOS) uses qualitative measures that characterize operational conditions within the traffic stream. The individual levels of service are described by factors that include speed, travel time, freedom to maneuver, traffic interruptions, and comfort and convenience. Six (6) levels of service are defined for each type of facility for which analysis procedures are available. They are given letter designations A through F, with LOS A representing the best operating conditions and LOS F the worst. Each level of service represents a range of operating conditions. Levels of service for intersections are defined within ranges of average control delay per vehicle, the number of seconds a vehicle can expect to wait due to the presence of a traffic control device. **Table 3** lists the level of service criteria for signalized and unsignalized intersections.

Table 3 – Intersection Level of Service Criteria

Level of Service	Control Delay (sec/veh)	
	Signalized	Unsignalized
A	≤ 10	≤ 10
B	> 10-20	> 10-15
C	> 20-35	> 15-25
D	> 35-55	> 25-35
E	> 55-80	> 35-50
F*	> 80 (or v/c>1)	> 50 (or v/c>1)

*Source: Exhibits 19-8, 20-2, 21-8, and 22-8,
 Highway Capacity Manual 2016*

Synchro 11 software using the methodologies of the latest (6th) edition of the *Highway Capacity Manual* (HCM 2016) will be used to calculate average per-vehicle control delays, from which movement, approach, and overall intersection levels of service are determined. Signal timing at the intersection of Scottsdale Road and Ashler Hills Drive were provided by the City of Scottsdale Engineer. The capacity analysis for the AM and PM peak hours at the site access, for existing, background (existing + east development), and total (background + site) are summarized in **Table 4**. The Synchro analysis worksheets are included as **Attachment G**.

Table 4 – 2021 Levels of Service and Delays

ID	Intersection	Intersection Control	Approach/Movement	Without Ocotillo Crossing Apartments					
				2022 Existing AM(PM)[SAT]		2022 No Build AM(PM)[SAT]		2022 Build AM(PM)[SAT]	
				Delays (s)	LOS	Delays (s)	LOS	Delays (s)	LOS
1	Scottsdale Rd. & Ashler Hills Dr.	Signal	NB	8.6 (11.7) [12.1]	A (B) [B]	9.5 (17.5) [17.4]	A (B) [B]	10.1 (17.8) [17.7]	B (B) [B]
			SB	10.4 (11.2) [12.0]	B (B) [B]	10.9 (15.9) [16.5]	B (B) [B]	10.8 (15.9) [16.5]	B (B) [B]
			EB	51.1 (49.5) [50.5]	D (D) [D]	53.8 (51.3) [52.1]	D (D) [D]	53.9 (51.3) [52.1]	D (D) [D]
			WB	44.5 (89.3) [81.6]	D (F) [F]	47.2 (45.1) [44.7]	D (D) [D]	47.4 (46.1) [45.5]	D (D) [D]
			Overall	14.0 (22.7) [21.3]	B (C) [C]	15.3 (21.6) [21.4]	B (C) [C]	15.6 (22.0) [21.7]	B (C) [C]
A	Ashler Hills Dr./74 th Way & Access A	1-way stop (SB)	SB Shared	- (-) [-] ⁽¹⁾	- (-) [-] ⁽¹⁾	0.0 (0.0) [0.0]	A (A) [A]	8.6 (8.6) [8.6]	A (A) [A]
			EB Left	- (-) [-] ⁽¹⁾	- (-) [-] ⁽¹⁾	0.0 (0.0) [0.0]	A (A) [A]	7.4 (7.4) [7.4]	A (A) [A]

(1) In the existing conditions, the roundabout is a 2-legged intersection. Synchro HCM does not analyze 2-legged intersection. Since there are no conflicting movements, this intersection was assumed to operate acceptably during the existing condition.

The results of capacity analysis of the study intersection summarized in **Table 4** shows that the proposed site access and the intersection of Scottsdale Road and Ashler Hills Drive is predicted to operate at acceptable levels of service (LOS D or better) with the exception of the westbound

approach in during PM and Saturday peak hour during the existing conditions. However, the overall level of service for the intersection is operating at an acceptable level of service of C or better. The delays with the added park traffic in the westbound direction were increased one second or less for the AM, PM and Saturday peak hours. The overall increase in delay for the intersection were 0.4 sec or less for AM, PM and Saturday peak hours.

The basic signal timing plan was utilized for all peak hour analyses. However, based on the City’s signal timing sheet, the eastbound through and westbound through lanes maximum split provided was less than the minimum split. The City’s Engineer asked CivTech to keep the signal timing consistent to the spreadsheet provided for the existing analysis only. For the No Build and Build conditions, CivTech mitigated the signal timing at the intersection of Scottsdale Road and Ashler Hills Drive to provide 120 seconds of cycle length and adjusted the green time to provide acceptable levels of service at all approaches.

With the mitigation of the signal timing, the intersection of Scottsdale Road and Ashler Hills Drive is expected to operate acceptably.

QUEUE STORAGE ANALYSIS

Adequate turn storage should be supplied on any approach where turn lanes are permitted and/or warranted. A queuing analysis was prepared according to the methodology documented in *AASHTO’s A Policy on Geometric Design of Highways and Streets*. The storage length for a turn lane is typically estimated as the length required to hold the average number of arriving vehicles per two minutes, where unsignalized. The equations used for the calculations are shown below, and the resulting turn lane storage requirements for the study intersection:

For unsignalized intersections, the storage length for a left turn lane is determined by the following equation:

$$\text{Storage Length} = \left\{ \frac{\ln[P(n>N)]}{\ln \frac{v}{c}} - 1 \right\} \times 25 \text{ feet}$$

as defined in *AASHTO’s A Policy on Geometric Design of Highways and Streets Equations 9-3 and 9-4*. Queue storage queue calculations worksheet is provided in **Attachment H**.

Table 5 – Queue Storage Lengths

ID	Intersection	Intersection Control	Movement	Queue Storage			
				Existing ⁽¹⁾	AASHTO	HCM ⁽²⁾	Recommended
2/A	Ashler Hills Dr./74 th Way & Access A	1-way stop (SB)	EB Left	TWLTL	25’	25’	93’

The results of the queue storage calculations indicate a queue storage of 25-feet for the eastbound left into the site. Based on Google Earth, there are approximately 230-feet of storage that can be queue back to the raised median on the west of the driveway. Per the site plan, a queue storage length of 93-feet was proposed for the eastbound left turn lane.

SIGHT DISTANCE ANALYSIS

Adequate sight distance must be provided at intersections and site access driveways to allow safe turning movements. There must be sufficient unobstructed sight distance along both approaches of a street/driveway intersection and across their included corners to allow operators of vehicles to see each other in time to prevent a collision. Along a tangent segment of roadway, the area that is to be unobstructed is a right triangle. The position of the driver about to exit the driveway is one (often called the origin) point of the triangle.

Sight distance measurement for this Project is based on City of Scottsdale methodology in accordance to Section 5-3C, Intersection & Driveway Sight Distance Requirements which adhere to ASSHTO’s calculation of sight distance. The City of Scottsdale set the point of the driver position at 5-feet to the right from the center of the driveway, 3.5 feet above the pavement, and a setback of 15-feet from the inner edge of curb. 74th Way/Ashler Hills Drive is a non-classified road with a posted speed limit of 25 mph; therefore, the assumed design speed is 5 mph over the posted speed limit. The City of Scottsdale and AASHTO’s calculation resulted in the same sight distance measurements. Sight distance calculations according to the City of Scottsdale guidelines are summarized in **Table 6**.

Table 6 – City of Scottsdale Sight Distance Requirements

Driveway	Posted Speed Limit/ Design Speed (mph)	Sight Distance Along Roadway	
		Through Lane	Left Turn Lane
Access A	25/30	290’	335’

Sight distance availability for traffic turning onto 74th Way/Ashler Hills Drive from the proposed site driveway (the north leg of the roundabout) was measured on Google Earth Pro and is provided in **Exhibit A**.

The City of Scottsdale criteria also states, “Sight lines are to be drawn on roadway and landscaping plans to represent the areas that must be free of all objects and topography in excess of 18 inches above the roadway surface, however, certain vegetation will be allowed. Vegetation placed within the sight triangle will be a low variety that remains below 18 inches when mature. Trees can be considered within the triangles as long the canopies are above 8 feet, they are a single trunk variety, and they are not spaced in a configuration that creates a “picket fence” effect.”

Sight visibility should be provided at all driveways according to the distances shown in **Table 5** and that sight triangles at public intersections are maintained according to Section 5-3 of the City of Scottsdale’s Code. All vegetation and trees should be maintained according to the City of Scottsdale’s regulations. Sight distance worksheets and Section 5-3 of the City of Scottsdale’s Code have been along with AASHTO’s sight distance calculations are included within **Attachment H**.

CONCLUSIONS

From the above, the following can be concluded:

- The proposed park consists of pickleball courts, a basketball court, picnic ramadas, and trails with 70 parking spaces located at Ashler Hills Drive at 74th Drive in the City of Scottsdale, Arizona.

- The proposed development is anticipated to generate 410 weekday daily trips, 47 trips during the typical weekday AM peak hour, 46 trips during the typical weekday PM peak hour, and 56 trips during the Saturday peak hour.
- The 24-hour bi-directional counts conducted along Ashler Hills Drive determined that there are approximately 521 total daily trips (269 eastbound approach and 252 westbound approach). The site generated weekday daily total will add only 410 trips and the east development site generated weekday daily total is projected to add 720 trips onto Ashler Hills Drive projecting the average daily to 1,643 total daily trips.
- Based on the highest peak hour generating less than 50 trips during the AM peak hour and only 56 trips estimated for the Saturday peak hour it was assumed that 70 parking spaces would be sufficient for the park.
- The results of the queue storage calculations indicate a queue storage of 25-feet for the eastbound left into the site. Based on Google Earth, there are approximately 230-feet of storage that can be queue back to the raised median on the west of the driveway. Per the site plan, a queue storage length of 93-feet was proposed for the eastbound left turn lane.

Thank you for allowing CivTech to assist you on this project. Please contact me with any questions you may have on this Traffic Statement.

Sincerely,

CivTech



David S. Duffy, P.E.
Senior Traffic Engineer

Attachments (9)

- A. City's Comments and Responses
- B. Site Plan
- C. COS Standard Detail Drawings
- D. Traffic Counts
- E. Trip Generation Calculations
- F. East Development Trip Generation Calculations
- G. Synchro Analyses
- H. Queue Storage Calculations
- I. Sight Distance Calculations and City's Requirements

Exhibit A – Sight Distance Photos

1st Submittal

Disposition Codes: (1) Will Comply (2) Will Evaluate (3) Delete Comment (4) Defer to Consultant/Owner

Reviewer Name, Agency: **Phil Kercher & Parker Murphy, City of Scottsdale**

Item	Review Comment	(Code) & Response
1.	Transportation - The site driveway should be designed in conformance with COS Driveway Type CL-1, COS Standard Detail #2256. The sidewalk across the driveway should be modified to conform to the driveway detail, not be separated so far from the curb line. DSPM 5-3.200; DSPM Sec. 5-3.205; COS Standard Detail Drawings - 2020 revision.	(1) Will comply. The design standard details is included as part of the attachments.
2.	Transportation - What speed limit is the sight visibility triangle based upon?	Sight distance triangle is 5 mph over the posted speed limit (30 mph).
3.	Transportation - Staff suggests moving the site driveway west of the traffic circle to improve sight triangle, or at circle but remove center island. Conceptual plan sent to CPM.	(1) The proposed driveway is now proposed to be at the roundabout.
4.	Traffic Study - Page 1 - Correct title to "74th Way" and remove references to 74th drive throughout the report.	(!) Will comply.
5.	Traffic Study - Page 2 - Remove or modify the statement that "there was a previously approved planned for this location with the location of the driveway on 74th Avenue instead of..." This site is on 74th Way. Staff was not aware of any previously approved plans.	(1) Will comply.
6.	Traffic Study - Page 2 - Remove or modify the statement this is not a traffic analysis. The study contains level of service analyses and is a traffic analysis, not just a trip generation statement.	(1) Will comply.
7.	Traffic Study - Page 4 - The trip generation estimates need to include AM peak hour trips for the pickleball courts and basketball courts. If necessary the consultant should do some count at existing City facilities.	(1) CivTech personnel conducted a field study and collected AM peak hour counts for the pickleball and basketball court at the Thompson Peak Park located west of Hayden Road and south of Thompson Peak Parkway.



1st Submittal

Disposition Codes: (1) Will Comply (2) Will Evaluate (3) Delete Comment (4) Defer to Consultant/Owner

Reviewer Name, Agency: **Phil Kercher & Parker Murphy, City of Scottsdale**

Item	Review Comment	(Code) & Response
8.	Traffic Study - Provide a trip generation estimate for the undeveloped property just east of the park site using the existing zoning and include these trips in the traffic analysis.	(1) CivTech reached out to Murphy Parker, the City Engineer and received information for the east development. The City does not have a site plan that informed that the development will be townhomes under LUC 215 in the ITE's Trip Generation 11th Edition with 101 DUs.
9.	Traffic Study - The study should comment on the proposed driveway location and necessary sight distance. The study should provide comment on the proposed location at the traffic circle.	(1) CivTech provided a section of the sight distance calculations as well as an exhibit with the sight distance measurements at the roundabout.
10.	Traffic Study - Study should collect traffic data east of the commercial driveways.	(1) new 24-hour bidirectional counts were conducted just east of 73rd St. and is provided as part of the attachments.
11.	Traffic Study - General, no changes required. ITE Trip Generation 11th Edition should be used be used for future submittals.	(1) analysis has been updated to ITE's Trip Generation, 11th Edition.
12.	Traffic Study - Ensure Synchro analysis utilizes existing signal timing as provided. Please resubmit the revise application requirements and additional information identified in Attachment A. Resubmittal Checklist, and a written summary response addressing the comments/corrections identified above as soon as possible for future review.	(1) CivTech utilized latest signal timing provided by the City. CivTech reached out to the City's Engineer and confirmed that the "Basic Timing Plan" can be used by it must match the timing sheet in the existing condition analysis even if the green time are less than the minimum time for the eastbound and westbound through movements. The City Engineer suggests that mitigation of the green time should happen in the "no-build" and "build" analysis.



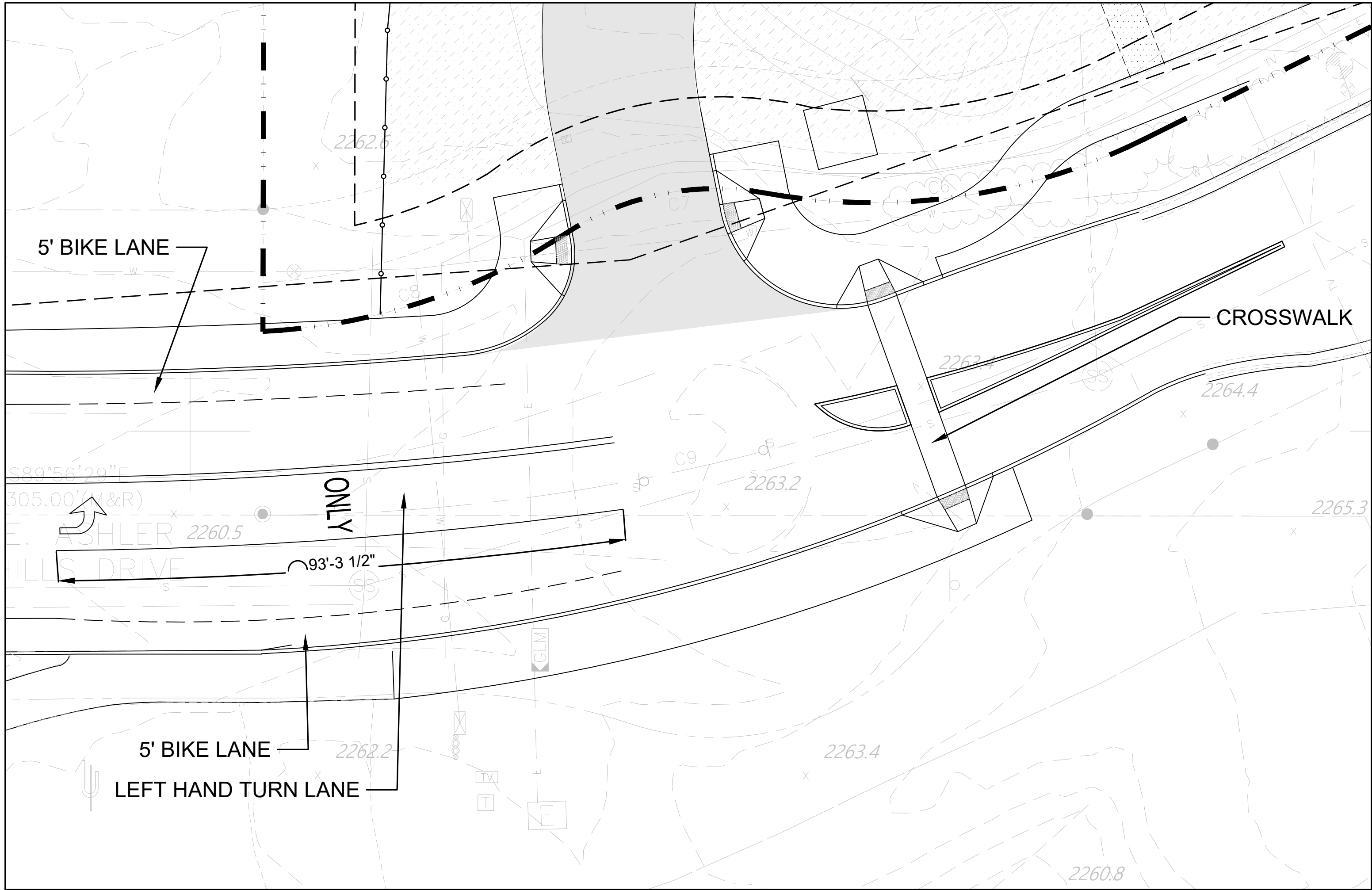

5' BIKE LANE

CROSSWALK

ONLY

5' BIKE LANE

LEFT HAND TURN LANE

93'-3 1/2"

$S89^{\circ}56'29"E$

305.00'(M&R)

E. ASHLER 2260.5

HILLS DRIVE

2262.2

2262.6

2263.2

2263.4

2263.4

2264.4

2265.3

2260.8

N 1010800

N 1010600

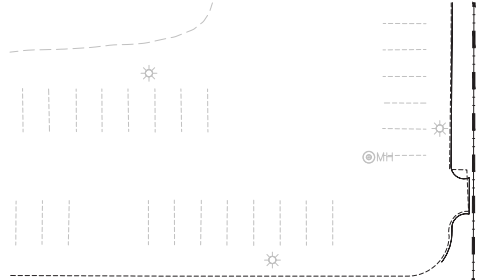

15' ZONING SETBACK

SVT

28'-11"

●

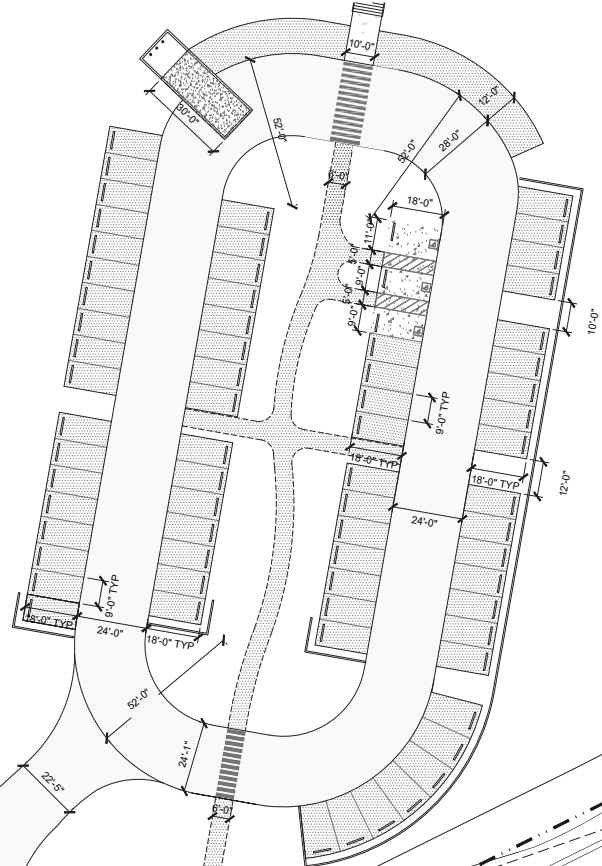

ASHLER HILLS DRIVE

NORTH 74TH V

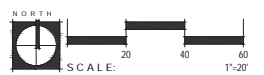

REVISED 6/25/19

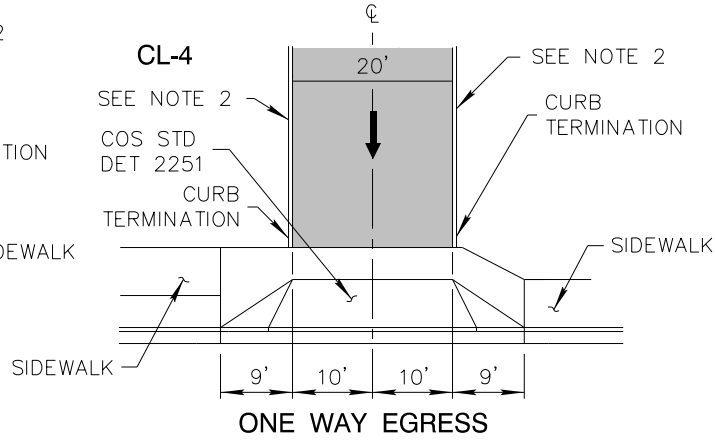
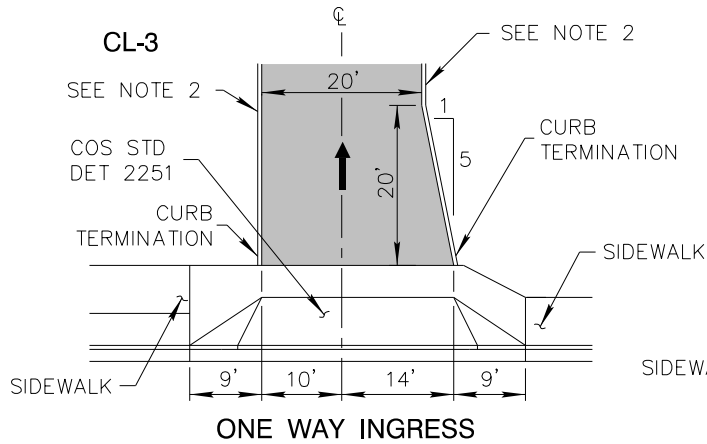

GENERAL NOTES

1. SIDEWALK SHALL CONFORM TO MAG STANDARD DETAIL 230 AND COS SECTION 340.
2. CURB AS CALLED FOR ON PLANS.
3. CURB & GUTTER SHALL CONFORM TO MAG STANDARD DETAIL 220. SINGLE CURB SHALL CONFORM TO MAG STANDARD DETAIL 222.
4. DRIVEWAY ENTRANCES SHALL CONFORM TO COS STANDARD DETAIL 2251 EXCEPT FOR MODIFICATIONS AS NOTED. DRIVEWAYS SHALL BE 3" AC A-1/2" ON 6" ABC UNLESS OTHERWISE NOTED. SEE PLANS FOR DRIVEWAY LIMITS.
5. CURB TERMINATION PER MAG STD DET 222.
6. WHEN INSTALLING NEW DRIVEWAYS ALONG AN EXISTING STREET, SAWCUT, REMOVE, & REPLACE A MINIMUM 2' WIDE STRIP OF AC PAVEMENT PER COS STANDARD DETAIL 2200.

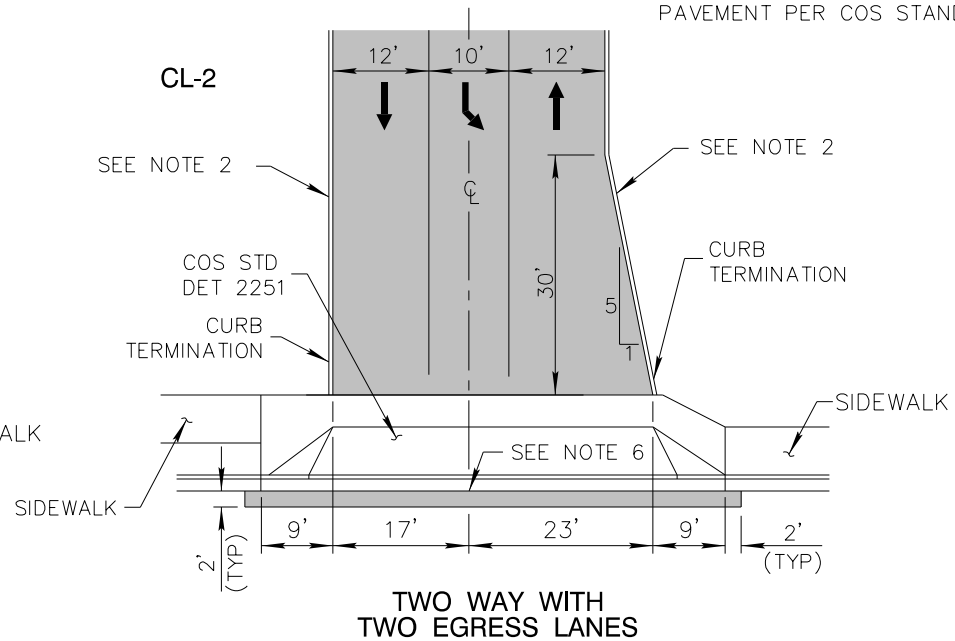
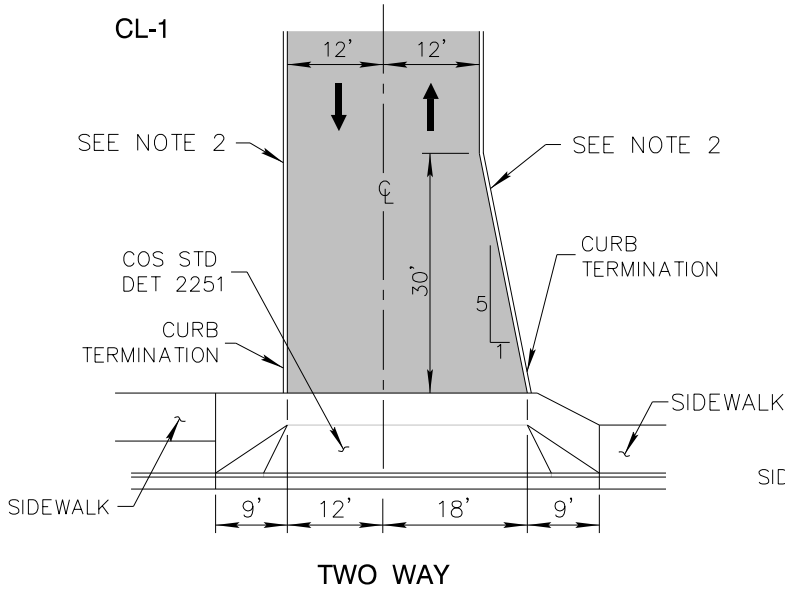

DETAIL NO. 2256

City of Scottsdale Standard Details

APPROVED BY: Scottsdale Standards & Specifications Committee

COMMERCIAL/INDUSTRIAL LOW VOLUME DRIVEWAY

DETAIL NO. 2256

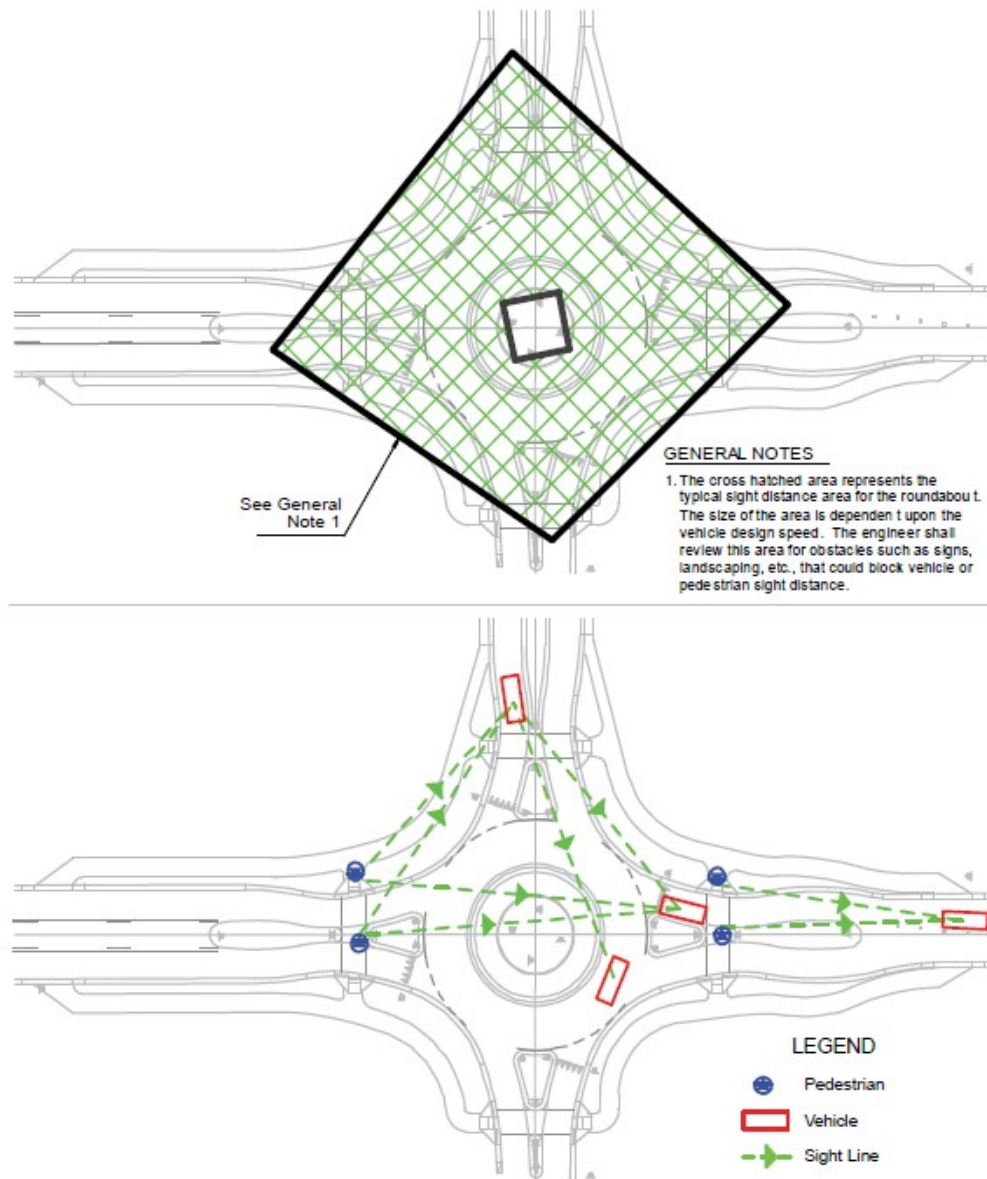

FIGURE 5-3.34 ROUNDABOUT SIGHT DISTANCE

STREET ACCESS AND DRIVEWAYS

5-3.2000

Driveway types are determined by land use type and street classification. The standards for these driveway types are illustrated in Figure 5-3.38 through Figure 5-3.43. Refer to Figure 5-3.39 for driveway grade standards.

DRIVEWAY SPACING

5-3.201

Standard and minimum driveway spacing will generally conform to the following standards. This minimum spacing applies to proposed site driveway separation as well

as separation from existing or planned driveways and streets on adjacent parcels. The spacing is measured to the driveway or street centerline.

STREET TYPE	STANDARD DRIVEWAY SPACING	MINIMUM DRIVEWAY SPACING
Local Residential / Local Collector	50 feet	50 feet
Local Industrial / Local Commercial	165 feet	125 feet
Minor Collector	165 feet	125 feet
Major Collector	250 feet	150 feet
Minor Arterial	330 feet	250 feet
Major Arterial	500 feet	300 feet

FIGURE 5-3.35 DRIVEWAY SPACING

Standard driveway spacing criteria shall apply for all new driveways where there are no conflicts with existing driveway and street intersections, site frontage is adequate, and there are no conflicts with natural features or drainage structures. The minimum driveway spacing may be allowed when approved by Transportation staff where those conflicts noted above exist or other site plan associated issues do not allow the standard driveway spacing to be implemented. In locations where the standard driveway spacing cannot be achieved, a deceleration lane may be required to mitigate the impact of the closer driveway spacing.

For sites that have frontage on two streets, primary access should be onto the minor street frontage. A maximum of two driveway openings is permitted to a site or parcel from the abutting street(s). The Transportation Department may permit additional driveway entrances when projected travel demands indicate it is in the interests of good traffic operation, and when adequate street frontage exists to maintain the above guidelines.

Where new development adjoins other similarly zoned property or compatible land uses, a cross access easement may be required to permit vehicular movement between the parcels or to reduce the number of access points required onto the adjacent public street. Combining driveways reduces the number of conflict points for pedestrians, bicyclists, and other vehicles. This may be required regardless of the development status of the adjoining property, unless the cross access is determined to be unfeasible by city staff.

New driveways on collector and arterial streets in areas that do not have raised medians shall align with existing or planned driveways and street intersections to avoid creating interlocking left turns and other conflicts. Offsets in the driveway centerlines may be allowed up to 6 feet. If the driveways cannot be aligned, the driveways should be offset a minimum distance of 125 feet along streets without a center turn lane, and a minimum 250 feet along streets with a center turn lane.

When site driveway locations are modified, any existing driveways that are not going to be utilized for access must be removed and replaced with curb, gutter, and sidewalk to match the adjacent improvements.

DRIVEWAY LOCATIONS

5-3.202

A new access driveway will not be allowed (measured to the driveway centerline):

- A. Within 30 feet of any commercial property line, except when it is a joint-use driveway serving two abutting commercial properties and access agreements have been exchanged between, and recorded by, the two abutting property owners;
- B. When the total width of all driveways serving a property exceeds 50 percent of the curb line frontage;
- C. Within 50 feet of the rights-of-way line of an intersecting non-arterial street;
- D. Within 100 feet of the rights-of-way line of an intersecting arterial street;
- E. Within 100 feet of an approved median opening location on an arterial street;
- F. Less than the minimum spacing as established under Section 5-3.201;

VEHICULAR NON-ACCESS EASEMENT

5-3.203

For proper control of driveway access, a vehicular non-access easement (V.N.E.) is to be granted to the city, except at approved access points, along all collector and arterial streets when abutting property develops.

RESIDENTIAL DRIVEWAYS

5-3.204

A. **Single-family Residential Development**

Driveways serving single-family residential units should be S-1 type driveways as shown in Figure 5-3.40. Only one driveway per lot street frontage is allowed except where the street frontage is of sufficient length to maintain a separation of 50 feet between driveways. The minimum driveway length is 18 feet, measured from the face of the garage opening to the back of sidewalk or the back of curb if no sidewalk is provided. Refer to Section 2-2.308 for additional discussion on driveways. Refer to Standard Detail Drawings (2200 Series) for access ramp design requirements.

B. **Multi-family Residential Development**

Driveways serving multi-family residential units should be CL and CH type driveways, as shown in Figure 5-3.41 through Figure 5-3.44. Type CL-1 and CL-2 are low-volume driveways to be used on local streets. Type CH-1, -2 and -3 are high volume driveways to be used on collector and arterial streets. CL type driveways may be required along urban character collector and arterial streets with higher pedestrian traffic. The minimum driveway length is 50 feet, measured from the entrance to the off-street parking area to the back of sidewalk, or to the back of curb if no sidewalk is provided. Refer to Standard Detail Drawings (2200 Series) for access ramp design requirements.

C. **Limitations on Residential Access**

Residential properties that have frontage on a local street, an arterial, or collector street are limited to local street access.

In some instances, residential parcels fronting only on arterial or collector streets may be given access if alternate public access is not available. When such access is allowed, the driveway must be circular, or it must have a turn-around area to ensure there is no need for backing onto the street.

NON-RESIDENTIAL DRIVEWAYS

Driveways for commercial and industrial development are shown on Figure 5-3.41 through Figure 5-3.44. The minimum length for a commercial or industrial driveway is 50 feet, measured from the entrance to the off-street parking area to the back of sidewalk or the back of curb if no sidewalk is provided. Driveway designs need to include a level path of travel across the driveway for pedestrians in conformance with ADA requirements.

A. **Commercial Driveways**

The "CL" and "CH" type driveways are designed to serve commercial properties. A "CL" type driveway is used for low-volume driveways on low volume streets. A "CH" type driveway is used for driveways on arterials, major collectors and high volume minor collectors, or at other locations when required by the Transportation Department. The CH-2 and CH-3 driveways are used at all access driveways opposite median openings. CL type driveways may be required along urban character collector and arterial streets with higher pedestrian traffic. Refer to Standard Detail Drawings (2200 Series) for access ramp design requirements.

B. **Industrial Driveways**

The CL-1 and CH-1 type driveways are typically used to serve industrial properties. Normally industrial access is not permitted on arterial or major collector streets; however, if such access is allowed, commercial driveway standards apply. Refer to Standard Detail Drawings (2200 Series) for access ramp design requirements.

**Intersection Turning Movement
Prepared by:**



Project #: 21-1247-001

TMC SUMMARY OF Scottsdale Rd & Ashler Hills Dr

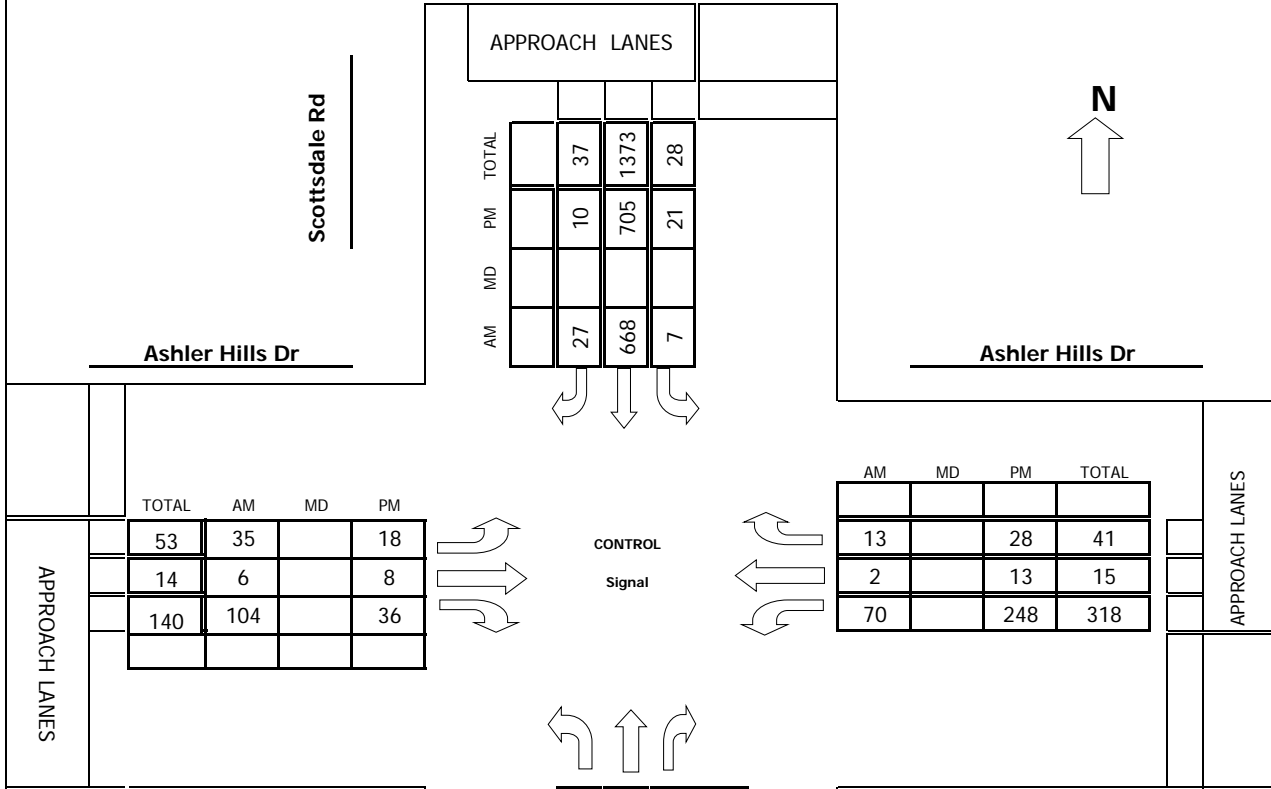

APPROACH LANES			
AM	MD	PM	TOTAL
27		10	37
668		705	1373
7		21	28

TOTAL	AM	MD	PM
132	93		39
1609	682		927
184	69		115

AM	MD	PM	TOTAL
13		28	41
2		13	15
70		248	318

LOCATION #: 21-1247-001

TURNING MOVEMENT COUNT

Scottsdale Rd & Ashler Hills Dr
(Intersection Name)

WEDNESDAY 04/14/21
Day Date

COUNT PERIODS	
AM	700AM - 900AM
NOON	-
PM	400PM - 600PM

AM PEAK HOUR 745 AM
NOON PEAK HOUR _____
PM PEAK HOUR 400 PM

Intersection Turning Movement

Prepared by:



FIELD DATA SERVICES OF ARIZONA, INC.
520.316.6745



N-S STREET: Scottsdale Rd DATE: 04/14/21 LOCATION: Scottsdale
 E-W STREET: Ashler Hills Dr DAY: WEDNESDAY PROJECT#: 21-1247-001

LANES:	NORTHBOUND			SOUTHBOUND			EASTBOUND			WESTBOUND			TOTAL
	NL	NT	NR	SL	ST	SR	EL	ET	ER	WL	WT	WR	
	1	2	1	1	1	2	1	1	0	1	1	0	
6:00 AM													
6:15 AM													
6:30 AM													
6:45 AM													
7:00 AM	45	122	3	1	136	2	1	0	13	10	1	1	335
7:15 AM	18	144	5	1	145	2	4	0	25	5	0	1	350
7:30 AM	11	117	4	2	172	7	7	1	17	9	0	2	349
7:45 AM	45	180	13	0	176	12	14	1	30	5	0	1	477
8:00 AM	33	146	14	4	151	8	14	2	44	14	1	5	436
8:15 AM	10	170	22	1	156	6	4	0	22	19	1	2	413
8:30 AM	5	186	20	2	185	1	3	3	8	32	0	5	450
8:45 AM	4	210	23	4	193	1	2	4	10	20	0	5	476
9:00 AM													
9:15 AM													
9:30 AM													
9:45 AM													
10:00 AM													
10:15 AM													
10:30 AM													
10:45 AM													
11:00 AM													
11:15 AM													
11:30 AM													
11:45 AM													

TOTAL	NL	NT	NR	SL	ST	SR	EL	ET	ER	WL	WT	WR	TOTAL
Volumes	171	1275	104	15	1314	39	49	11	169	114	3	22	3286
Approach %	11.03	82.26	6.71	1.10	96.05	2.85	21.40	4.80	73.80	82.01	2.16	15.83	
App/Depart	1550	/	1346	1368	/	1597	229	/	130	139	/	213	

AM Peak Hr Begins at: 745 AM

PEAK

Volumes	93	682	69	7	668	27	35	6	104	70	2	13	1776
Approach %	11.02	80.81	8.18	1.00	95.16	3.85	24.14	4.14	71.72	82.35	2.35	15.29	

PEAK HR.

FACTOR:	0.887	0.934	0.604	0.574	0.931
---------	-------	-------	-------	-------	-------

CONTROL: Signal

COMMENT 1:

GPS: 33.777534, -111.925847

Intersection Turning Movement



FIELD DATA SERVICES OF ARIZONA, INC.
520.316.6745



N-S STREET: Scottsdale Rd DATE: 04/14/21 LOCATION: Scottsdale
 E-W STREET: Ashler Hills Dr DAY: WEDNESDAY PROJECT# 21-1247-001

LANES:	NORTHBOUND			SOUTHBOUND			EASTBOUND			WESTBOUND			TOTAL
	NL	NT	NR	SL	ST	SR	EL	ET	ER	WL	WT	WR	
	1	2	1	1	1	2	1	1	0	1	1	0	
1:00 PM													
1:15 PM													
1:30 PM													
1:45 PM													
2:00 PM													
2:15 PM													
2:30 PM													
2:45 PM													
3:00 PM													
3:15 PM													
3:30 PM													
3:45 PM													
4:00 PM	13	224	36	8	201	3	5	2	11	70	2	9	584
4:15 PM	8	225	31	5	170	1	3	3	10	63	4	12	535
4:30 PM	8	248	24	8	175	3	5	1	7	65	3	2	549
4:45 PM	10	230	24	0	159	3	5	2	8	50	4	5	500
5:00 PM	11	207	25	5	193	2	2	1	12	51	3	3	515
5:15 PM	10	214	33	5	155	4	6	3	10	44	3	5	492
5:30 PM	12	224	21	6	154	1	2	1	7	47	4	5	484
5:45 PM	7	223	19	2	137	3	2	0	6	54	1	8	462
6:00 PM													
6:15 PM													
6:30 PM													
6:45 PM													

TOTAL	NL	NT	NR	SL	ST	SR	EL	ET	ER	WL	WT	WR	TOTAL
Volumes	79	1795	213	39	1344	20	30	13	71	444	24	49	4121
Approach %	3.79	86.01	10.21	2.78	95.79	1.43	26.32	11.40	62.28	85.88	4.64	9.48	
App/Depart	2087	/	1874	1403	/	1859	114	/	265	517	/	123	

PM Peak Hr Begins at: 400 PM

PEAK

Volumes	39	927	115	21	705	10	18	8	36	248	13	28	2168
Approach %	3.61	85.75	10.64	2.85	95.79	1.36	29.03	12.90	58.06	85.81	4.50	9.69	

PEAK HR.

FACTOR:	0.965	0.868	0.861	0.892	0.928
---------	-------	-------	-------	-------	-------

CONTROL: Signal
 COMMENT 1: 0
 GPS: 33.777534, -111.925847

**Intersection Turning Movement
Prepared by:**



Project #: 21-1247-003

TMC SUMMARY OF Scottsdale Rd & Ashler Hills Dr

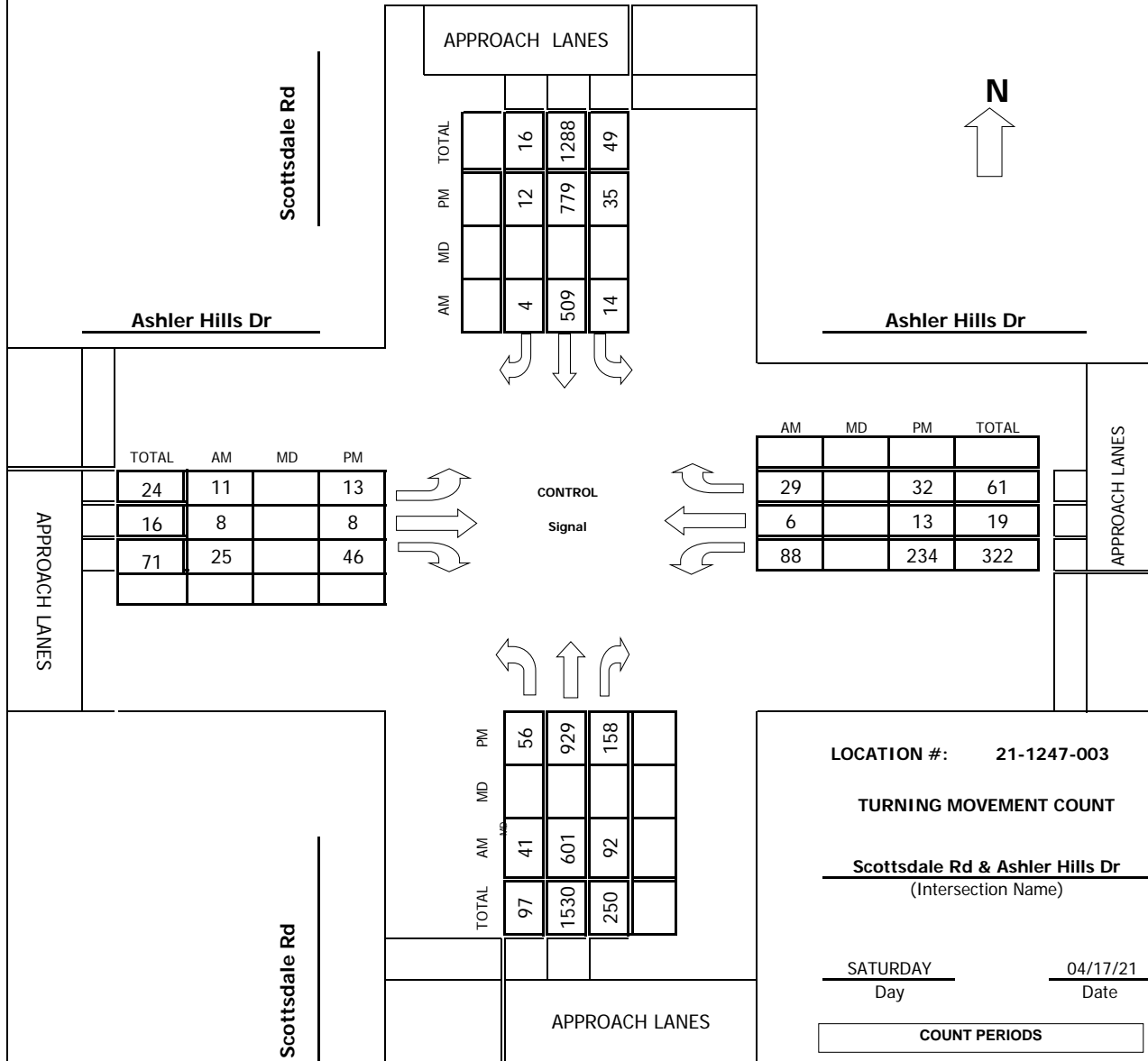

TOTAL	AM	MD	PM
24	11		13
16	8		8
71	25		46

AM	MD	PM	TOTAL
29		32	61
6		13	19
88		234	322

TOTAL	AM	MD	PM
97	41		56
1530	601		929
250	92		158

LOCATION #: 21-1247-003

TURNING MOVEMENT COUNT

Scottsdale Rd & Ashler Hills Dr
(Intersection Name)

SATURDAY
Day

04/17/21
Date

COUNT PERIODS

AM	700AM	-	900AM
NOON		-	
PM	1100AM	-	100PM

AM PEAK HOUR 800 AM

NOON PEAK HOUR _____

PM PEAK HOUR 1115 AM

Intersection Turning Movement

Prepared by:



FIELD DATA SERVICES OF ARIZONA, INC.
520.316.6745



N-S STREET: Scottsdale Rd DATE: 04/17/21 LOCATION: Scottsdale
 E-W STREET: Ashler Hills Dr DAY: SATURDAY PROJECT#: 21-1247-003

LANES:	NORTHBOUND			SOUTHBOUND			EASTBOUND			WESTBOUND			TOTAL
	NL	NT	NR	SL	ST	SR	EL	ET	ER	WL	WT	WR	
	1	2	1	1	1	2	1	1	0	1	1	0	
6:00 AM													
6:15 AM													
6:30 AM													
6:45 AM													
7:00 AM	0	78	7	0	64	1	1	0	3	3	0	0	157
7:15 AM	4	76	8	2	72	0	2	0	2	6	0	1	173
7:30 AM	4	100	14	4	85	1	3	0	9	6	0	3	229
7:45 AM	9	124	16	3	82	1	2	2	9	10	0	4	262
8:00 AM	9	154	26	3	129	1	1	4	1	17	0	7	352
8:15 AM	9	118	21	4	114	1	1	1	8	20	5	9	311
8:30 AM	8	152	19	2	128	0	5	0	5	25	1	10	355
8:45 AM	15	177	26	5	138	2	4	3	11	26	0	3	410
9:00 AM													
9:15 AM													
9:30 AM													
9:45 AM													
10:00 AM													
10:15 AM													
10:30 AM													
10:45 AM													
11:00 AM													
11:15 AM													
11:30 AM													
11:45 AM													

TOTAL	NL	NT	NR	SL	ST	SR	EL	ET	ER	WL	WT	WR	TOTAL
Volumes	58	979	137	23	812	7	19	10	48	113	6	37	2249
Approach %	4.94	83.39	11.67	2.73	96.44	0.83	24.68	12.99	62.34	72.44	3.85	23.72	
App/Depart	1174	/	1035	842	/	973	77	/	170	156	/	71	

AM Peak Hr Begins at: 800 AM

PEAK

Volumes	41	601	92	14	509	4	11	8	25	88	6	29	1428
Approach %	5.59	81.88	12.53	2.66	96.58	0.76	25.00	18.18	56.82	71.54	4.88	23.58	

PEAK HR.

FACTOR:	0.842	0.909	0.611	0.854	0.871
---------	-------	-------	-------	-------	-------

CONTROL: Signal

COMMENT 1:

GPS: 33.777534, -111.925847

Intersection Turning Movement



FIELD DATA SERVICES OF ARIZONA, INC.
520.316.6745



N-S STREET: Scottsdale Rd DATE: 04/17/21 LOCATION: Scottsdale
 E-W STREET: Ashler Hills Dr DAY: SATURDAY PROJECT#: 21-1247-003

LANES:	NORTHBOUND			SOUTHBOUND			EASTBOUND			WESTBOUND			TOTAL
	NL	NT	NR	SL	ST	SR	EL	ET	ER	WL	WT	WR	
	1	2	1	1	1	2	1	1	0	1	1	0	
10:00 AM													
10:15 AM													
10:30 AM													
10:45 AM													
11:00 AM	14	209	25	11	199	1	4	1	9	47	2	2	524
11:15 AM	13	216	39	13	198	5	2	3	14	69	2	6	580
11:30 AM	10	228	34	8	197	2	5	2	13	59	4	4	566
11:45 AM	16	256	44	10	190	1	1	3	11	57	3	10	602
12:00 PM	17	229	41	4	194	4	5	0	8	49	4	12	567
12:15 PM	13	213	38	10	200	0	4	3	5	63	0	8	557
12:30 PM	21	214	43	12	178	3	4	1	10	49	2	9	546
12:45 PM	11	247	30	7	189	5	4	3	6	62	7	10	581
1:00 PM													
1:15 PM													
1:30 PM													
1:45 PM													
2:00 PM													
2:15 PM													
2:30 PM													
2:45 PM													
3:00 PM													
3:15 PM													
3:30 PM													
3:45 PM													

TOTAL	NL	NT	NR	SL	ST	SR	EL	ET	ER	WL	WT	WR	TOTAL
Volumes	115	1812	294	75	1545	21	29	16	76	455	24	61	4523
Approach %	5.18	81.58	13.24	4.57	94.15	1.28	23.97	13.22	62.81	84.26	4.44	11.30	
App/Depart	2221	/	1902	1641	/	2076	121	/	385	540	/	160	

PM Peak Hr Begins at: 1115 AM

PEAK

Volumes	56	929	158	35	779	12	13	8	46	234	13	32	2315
Approach %	4.90	81.28	13.82	4.24	94.31	1.45	19.40	11.94	68.66	83.87	4.66	11.47	

PEAK HR.

FACTOR:	0.904	0.956	0.838	0.906	0.961
---------	-------	-------	-------	-------	-------

CONTROL: Signal
 COMMENT 1: 0
 GPS: 33.777534, -111.925847

Start Date: 3/17/2022						
Start Time: 12:00:00 AM						
Site Code: 1						
Station ID:						
Location 1: ASHLER HILLS DR E.O 73RD ST						
Date	Time	EB	WB			
3/17/2022	12:00 AM	1	1			
3/17/2022	12:15 AM	0	0			
3/17/2022	12:30 AM	0	0			
3/17/2022	12:45 AM	2	0			
3/17/2022	01:00 AM	0	0			
3/17/2022	01:15 AM	0	0			
3/17/2022	01:30 AM	0	0			
3/17/2022	01:45 AM	0	0			
3/17/2022	02:00 AM	0	0			
3/17/2022	02:15 AM	0	0			
3/17/2022	02:30 AM	0	0			
3/17/2022	02:45 AM	0	0			
3/17/2022	03:00 AM	0	0			
3/17/2022	03:15 AM	0	0			
3/17/2022	03:30 AM	0	0			
3/17/2022	03:45 AM	0	0			
3/17/2022	04:00 AM	1	1			
3/17/2022	04:15 AM	0	0			
3/17/2022	04:30 AM	0	0			
3/17/2022	04:45 AM	0	0			
3/17/2022	05:00 AM	0	0			
3/17/2022	05:15 AM	0	0			
3/17/2022	05:30 AM	0	0			
3/17/2022	05:45 AM	1	1			
3/17/2022	06:00 AM	0	2			
3/17/2022	06:15 AM	0	0			
3/17/2022	06:30 AM	0	0			
3/17/2022	06:45 AM	0	0	EB	WB	Total
3/17/2022	07:00 AM	1	1			
3/17/2022	07:15 AM	0	2			
3/17/2022	07:30 AM	2	2			
3/17/2022	07:45 AM	3	3			
3/17/2022	08:00 AM	0	2	6	8	14
3/17/2022	08:15 AM	1	1	5	9	14
3/17/2022	08:30 AM	4	3	6	8	14
3/17/2022	08:45 AM	1	4	8	9	17
3/17/2022	09:00 AM	3	5	6	10	16
3/17/2022	09:15 AM	3	5			
3/17/2022	09:30 AM	2	7			
3/17/2022	09:45 AM	7	2			
3/17/2022	10:00 AM	3	9			
3/17/2022	10:15 AM	10	6			
3/17/2022	10:30 AM	5	6			
3/17/2022	10:45 AM	7	6			
3/17/2022	11:00 AM	6	5			

3/17/2022	11:15 AM	2	4			
3/17/2022	11:30 AM	3	7			
3/17/2022	11:45 AM	6	7			
3/17/2022	12:00 PM	7	4			
3/17/2022	12:15 PM	5	7			
3/17/2022	12:30 PM	9	6			
3/17/2022	12:45 PM	7	8			
3/17/2022	01:00 PM	4	4			
3/17/2022	01:15 PM	5	6			
3/17/2022	01:30 PM	1	4			
3/17/2022	01:45 PM	7	8			
3/17/2022	02:00 PM	7	6			
3/17/2022	02:15 PM	7	7			
3/17/2022	02:30 PM	4	5			
3/17/2022	02:45 PM	1	3			
3/17/2022	03:00 PM	3	2			
3/17/2022	03:15 PM	5	3			
3/17/2022	03:30 PM	4	3			
3/17/2022	03:45 PM	8	6	EB	WB	Total
3/17/2022	04:00 PM	10	1			
3/17/2022	04:15 PM	6	3			
3/17/2022	04:30 PM	5	9			
3/17/2022	04:45 PM	4	3			
3/17/2022	05:00 PM	1	3	25	16	41
3/17/2022	05:15 PM	6	7	16	18	34
3/17/2022	05:30 PM	6	3	16	22	38
3/17/2022	05:45 PM	11	7	17	16	33
3/17/2022	06:00 PM	8	9	24	20	44
3/17/2022	06:15 PM	7	2			
3/17/2022	06:30 PM	2	2			
3/17/2022	06:45 PM	3	8			
3/17/2022	07:00 PM	4	2			
3/17/2022	07:15 PM	3	2			
3/17/2022	07:30 PM	1	3			
3/17/2022	07:45 PM	2	0			
3/17/2022	08:00 PM	3	0			
3/17/2022	08:15 PM	4	1			
3/17/2022	08:30 PM	3	3			
3/17/2022	08:45 PM	5	1			
3/17/2022	09:00 PM	1	0			
3/17/2022	09:15 PM	3	2			
3/17/2022	09:30 PM	2	0			
3/17/2022	09:45 PM	4	0			
3/17/2022	10:00 PM	1	0			
3/17/2022	10:15 PM	1	2			
3/17/2022	10:30 PM	2	4			
3/17/2022	10:45 PM	1	1			
3/17/2022	11:00 PM	0	0			
3/17/2022	11:15 PM	0	0			
3/17/2022	11:30 PM	1	0			
3/17/2022	11:45 PM	1	0			
	Total	269	252			

Methodology Overview

This form facilitates trip generation estimation using data within the Institute of Transportation Engineer's (ITE) Trip Generation Manual, 11th Edition and methodology described within ITE's Trip Generation Handbook, 3rd Edition. These references will be referred to as Manual and Handbook, respectively. The Manual contains data collected by various transportation professionals for a wide range of different land uses, with each land use category represented by a land use code (LUC). Average rates and equations have been established that correlate the relationship between an independent variable that describes the development size and generated trips for each categorized LUC in various settings and time periods. The Handbook indicates an established methodology for how to use data contained within the Manual when to use the fitted curve instead of the average rate and when to adjustments to the volume of trips are appropriate and how to do so. The methodology steps are represented visually in boxes in Figure 3.1. This worksheet applies calculations for each box if applicable.

Box 1 - Define Study Site Land Use Type & Site Characteristics

The analyst is to pick an appropriate LUC(s) based on the subject's zoning/land use(s)/future land use(s). The size of the land use(s) is described in reference to an independent variable(s) specific to (each) the land use (example: 1,000 square feet of building area is relatively common).

Land Use Types and Size

Proposed Use	Amount Units	ITE LUC	ITE Land Use Name
Park	6.800 Acres	411	Public Park
Pickleball	8 Courts	490	Tennis Courts
Basketball	1 Courts	490	Racquet/ Tennis Club

Box 2 - Define Site Context

Context assessment is to "simply determine whether the study sites is in a multimodal setting" and "could have persons accessing the site by walking, bicycling, or riding transit." This assessment is used in Box 4. The Manual separates data into 4 setting categories - Rural, General Urban/Suburban, Dense Multi-Urban Use and Center City Core. This worksheet uses the following abbreviations, respectively: R, G, D, and C. The Manual does not have data for all settings of all land use codes. See the table on the next page titled "Site Context and Time Periods" - if this table is not provided, the "General Urban/Suburban" setting is used by default.

Box 3 - Define Analysis Objectives Types of Trips & Time Period

This tool will focus on vehicular trips for a 24-hour period on a typical weekday as well as its AM peak hour and PM peak hour. Other time period(s) may be of interest.

Site Context and Time Periods - Actual Setting, Setting Data Available for LUC, Setting Used in Analyses

Proposed Use	Setting	ADT		AM Peak Hour		PM Peak Hour		Saturday	
		Available	Used	Available	Used	Available	Used	Available	Used
Park	General Urban/Suburban	G	G	G	G	G	G		N/A
Pickleball	General Urban/Suburban	G	G		N/A	G	G		N/A
Basketball	General Urban/Suburban	G	G		N/A	G	G		N/A

If the desired setting is not available within the *Manual*, adjustments may be made in Boxes 6 through 8.

Box 4 - Is Study Site Multimodal?

Per the Handbook, "if the objective is to establish a local trip generation rate for a particular land use or study site, the simplified approach (Box 9) may be acceptable but the Box 5 through 8 approach is required if the study site is located in an infill setting, contains a mix of uses on-site, or is near significant transit service."

Box 5/Box 9 - Estimate Baseline Trips/Estimate Vehicular Trips (Determine Equation)

Vehicle trips are estimated using rates/equations applicable to each LUC. When the appropriate graph has a fitted curve, the Handbook has a process (Figure 4.2) to determine when to use it versus using the weighted average rate or collecting local data. The methodology requires for engineering judgement in some circumstances and permits engineering judgement to override or make adjustments when appropriate to best project (example 1: study site is expected to operate differently than data in the applicable land use code - such as restaurant that is closed in the morning or in the evening; example 2: LUC data in a localized area fails to be represented by the typically selected fitted curve/weighted average rate - a small shop/LUC 820, AM peak hour is skewed by the high y-intercept).

Equation Type: Equation Used [Equated Rate] (Type Abbreviations: Weighted Average Rate ("WA"), Fitted Curve ("FC"), or Custom ("C"))

Proposed Use	ADT	AM Peak Hour	PM Peak Hour	Saturday
Park	FC: $T=0.64 \cdot X + 88.46$ [13.65]	WA: $T=X \cdot 0.02$ [0.02]	WA: $T=X \cdot 0.11$ [0.11]	C: $T=X \cdot 1.96$ [1.96]
Pickleball	WA: $T=X \cdot 30.32$ [30.32]	C: $T=X \cdot 5.83$ [5.83]	WA: $T=X \cdot 4.21$ [4.21]	C: $T=X \cdot 5.83$ [5.83]
Basketball	C: $T=X \cdot 75.8$ [75.80]	C: $T=X \cdot 0$ [0.00]	C: $T=X \cdot 10.525$ [10.53]	C: $T=X \cdot 6.63$ [6.63]

Box 5/Box 9 - Estimate Baseline Trips/Estimate Vehicular Trips (Apply Equations and in/out Distributions)

Baseline Vehicular Trips

Proposed Use	ADT				AM Peak Hour				PM Peak Hour				Saturday			
	% In	In	Out	Total	% In	In	Out	Total	% In	In	Out	Total	% In	In	Out	Total
Park	50%	46	46	92	59%	0	0	0	55%	1	0	1	50%	7	6	13
Pickleball	50%	121	121	242	80%	38	9	47	50%	17	17	34	80%	38	9	47
Basketball	50%	38	38	76	0%	0	0	0	50%	6	5	11	50%	4	3	7
Totals		205	205	410		38	9	47		24	22	46		49	18	67

CivTech Field Data

21-0480: Pickleball and Basketball Surveying

Monday, March 21, 2022

Basketball					
	Time		Carpool?	Number of Vehicle	Number of People
	Arrival	Departure			
7:00 AM					
7:05 AM					
7:10 AM					
7:15 AM					
7:20 AM					
7:25 AM					
7:30 AM					
7:35 AM					
7:40 AM					
7:45 AM					
7:50 AM					
7:55 AM					
8:00 AM					
8:05 AM					
8:10 AM					
8:15 AM					
8:20 AM					
8:25 AM					
8:30 AM					
8:35 AM					
8:40 AM					
8:45 AM					
8:50 AM					
8:55 AM					
9:00 AM					

Monday, March 21, 2022

Pickleball					
	Time		Carpool?	Number of Vehicle	Number of People
	Arrival	Departure			
7:00 AM	y			1	1
7:05 AM	y		y	1	2
7:10 AM	y			1	1
7:15 AM	y, y			1,1	1,1
7:20 AM	y			1	1
7:25 AM	y (D.O)	y		1, 1	1, 1
7:30 AM	y, y, y			1, 1, 1	1, 1, 1
7:35 AM	y, y		n, y	1, 1	1, 2
7:40 AM	y			1	1
7:45 AM	y			1	1
7:50 AM		y		1	1
7:55 AM	y, y, y, y	y	y, n, n, n	1, 1, 1, 1, 1	2, 1, 1, 1, 1
8:00 AM	y, y, y, y			1, 1, 1, 1	1, 1, 1, 1
8:05 AM	y, y, y (D.O)	y		1, 1, 1, 1	1, 1, 1, 1
8:10 AM	y		y	1	2
8:15 AM	y, y, y		n, y, y	1, 1, 1	1, 2, 2
8:20 AM	y, y (D.O), y, y	y	y, n, n	1, 1, 1, 1, 1	2, 1, 1, 1, 1
8:25 AM	y, y, y	y		1, 1, 1, 1	1, 1, 1, 1
8:30 AM					
8:35 AM	y, y, y		y	1, 1, 1	2, 1, 1
8:40 AM	y, y	y, y		1, 1, 1, 1	1, 1, 1, 1
8:45 AM					
8:50 AM	y, y, y, y			1, 1, 1, 1	1, 1, 1, 1
8:55 AM		y, y	y, n	1, 1,	2, 1
9:00 AM	y, y		n, y	1, 1	1, 2

Pickleball		
	Time	
	Arrival	Departure
7:00 AM	1	
7:05 AM	1	
7:10 AM	1	
7:15 AM	2	
7:20 AM	1	
7:25 AM	1	1
7:30 AM	3	
7:35 AM	2	
7:40 AM	1	
7:45 AM	1	
7:50 AM		1
7:55 AM	4	1
8:00 AM	4	
8:05 AM	3	1
8:10 AM	1	
8:15 AM	3	
8:20 AM	4	1
8:25 AM	3	1
8:30 AM	0	0
8:35 AM	3	
8:40 AM	2	2
8:45 AM	0	0
8:50 AM	4	
8:55 AM		2
9:00 AM	2	

Time	Every 15 Mins		Every Hour	
	Ins	Outs	Ins	Outs
7:00 AM				
7:15 AM		3		0
7:30 AM		4		1
7:45 AM		6		0
8:00 AM		5	2	13
8:15 AM		8	1	18
8:30 AM		10	2	23
8:45 AM		5	2	29
9:00 AM		6	2	28

Ratio of 6 courts (in the filed) to 8 courts (proposed) 1.33

Peak Hour Trips		
Ins	Outs	Total
38	9	47

AM Rates	
Total	5.83
Ins	80%
Out	20%

Additional Notes:

D.O = Drop off

1 motor vehicle

y = yes

n = no

Eventually, around 7:45 AM, the basketball court was transformed into more pickleball courts

Every Hour is based on the "Every 15 mins" calculations

Methodology Overview

This form facilitates trip generation estimation using data within the Institute of Transportation Engineer's (ITE) Trip Generation Manual, 11th Edition and methodology described within ITE's Trip Generation Handbook, 3rd Edition. These references will be referred to as Manual and Handbook, respectively. The Manual contains data collected by various transportation professionals for a wide range of different land uses, with each land use category represented by a land use code (LUC). Average rates and equations have been established that correlate the relationship between an independent variable that describes the development size and generated trips for each categorized LUC in various settings and time periods. The Handbook indicates an established methodology for how to use data contained within the Manual when to use the fitted curve instead of the average rate and when to adjustments to the volume of trips are appropriate and how to do so. The methodology steps are represented visually in boxes in Figure 3.1. This worksheet applies calculations for each box if applicable.

Box 1 - Define Study Site Land Use Type&Site Characteristics,

Box 2 - Define Site Context | Box 3 - Define Analysis Objectives Trip Types&Time Period

The analyst is to pick an appropriate LUC(s) based on the subject's zoning/land use(s)/future land use(s). The size of the land use(s) is described in reference to an independent variable(s) specific to (each) the land use (example: 1,000 square feet of building area is relatively common). Context assessment is to "simply determine whether the study sites is in a multimodal setting" and "could have persons accessing the site by walking, bicycling, or riding transit." This assessment is used in Box 4. The Manual separates data into 4 setting categories - Rural, General Urban/Suburban, Dense Multi-Urban Use and Center City Core. This worksheet uses the following abbreviations, respectively: R, G, D, and C. The Manual does not have data for all settings of all land use codes. The "General Urban/Suburban" setting is used by default.

This tool will focus on vehicular trips for a 24-hour period on a typical weekday as well as its AM peak hour and PM peak hour. Other time period(s) may be of interest.

Land Use Types and Size

Proposed Use	Amount Units	ITE LUC	ITE Land Use Name
Single Family Attached	101 Dwelling Units	215	Single-Family Attached Housing

Box 4 - Is Study Site Multimodal?

Per the Handbook, "if the objective is to establish a local trip generation rate for a particular land use or study site, the simplified approach (Box 9) may be acceptable but the Box 5 through 8 approach is required if the study site is located in an infill setting, contains a mix of uses on-site, or is near significant transit service."

Box 5/Box 9 - Estimate Baseline Trips/Estimate Vehicular Trips (Determine Equation)

Vehicle trips are estimated using rates/equations applicable to each LUC. When the appropriate graph has a fitted curve, the Handbook has a process (Figure 4.2) to determine when to use it versus using the weighted average rate or collecting local data. The methodology requires for engineering judgement in some circumstances and permits engineering judgement to override or make adjustments when appropriate to best project (example 1: study site is expected to operate differently than data in the applicable land use code - such as restaurant that is closed in the morning or in the evening; example 2: LUC data in a localized area fails to be represented by the typically selected fitted curve/weighted average rate - a small shop/LUC 820, AM peak hour is skewed by the high y-intercept).

Equation Type: Equation Used [Equated Rate] (Type Abbreviations: Weighted Average Rate ("WA"), Fitted Curve Type: Equation Used [Equated Rate])

Proposed Use	ADT	AM Peak Hour	PM Peak Hour	Saturday
Single Family Attached	FC: T=7.62*X-50.48 [7.12]	FC: T=0.52*X-5.7 [0.46]	FC: T=0.6*X-3.93 [0.56]	WA: T=X*0.57 [0.57]

Box 5/Box 9 - Estimate Baseline Trips/Estimate Vehicular Trips (Apply Equations and in/out Distributions)

Baseline Vehicular Trips

Proposed Use	ADT				AM Peak Hour				PM Peak Hour				Saturday			
	% In	In	Out	Total	% In	In	Out	Total	% In	In	Out	Total	% In	In	Out	Total
Single Family Attached	50%	360	360	720	31%	15	32	47	57%	32	25	57	48%	28	30	58

External Vehicular Trips

Proposed Use	ADT				AM Peak Hour				PM Peak Hour				Saturday														
	In	Out	Total		In	Out	Total		In	Out	Total		In	Out	Total												
Single Family Attached				360				15				32				25				28				30			58
Totals				360				15				32				25				28				30			58

Net New Trips. Pass-by trips and truck trips may be subtracted from the total external vehicle trips, if applicable/data available. Diverted link trips may also be separated, but are often (conservatively) grouped with primary trips.

Net New Trips

Proposed Use	ADT				AM Peak Hour				PM Peak Hour				Saturday														
	In	Out	Total		In	Out	Total		In	Out	Total		In	Out	Total												
Single Family Attached				360				15				32				25				28				30			58
Totals				360				15				32				25				28				30			58



Lane Group	EBL	EBT	WBL	WBT	WBR	NBL	NBT	NBR	SBL	SBT	SBR
Lane Configurations	↖	↗	↖	↗	↗	↖	↗	↗	↖	↗	↗
Traffic Volume (vph)	35	6	71	2	13	94	689	70	7	675	27
Future Volume (vph)	35	6	71	2	13	94	689	70	7	675	27
Turn Type	pm+pt	NA	pm+pt	NA	Perm	pm+pt	NA	Perm	pm+pt	NA	Perm
Protected Phases	3	8	7	4		1	6		5	2	
Permitted Phases	8		4		4	6		6	2		2
Detector Phase	3	8	7	4	4	1	6	6	5	2	2
Switch Phase											
Minimum Initial (s)	5.0	7.0	5.0	7.0	7.0	5.0	10.0	10.0	5.0	10.0	10.0
Minimum Split (s)	10.0	36.6	10.0	34.6	34.6	11.4	27.1	27.1	11.4	22.1	22.1
Total Split (s)	15.0	25.0	15.0	25.0	25.0	20.0	50.0	50.0	20.0	50.0	50.0
Total Split (%)	13.6%	22.7%	13.6%	22.7%	22.7%	18.2%	45.5%	45.5%	18.2%	45.5%	45.5%
Yellow Time (s)	3.0	3.3	3.0	3.3	3.3	4.4	5.1	5.1	4.4	5.1	5.1
All-Red Time (s)	2.0	2.3	2.0	2.3	2.3	2.0	1.0	1.0	2.0	1.0	1.0
Lost Time Adjust (s)	0.0	0.0	0.0	0.0	0.0	0.0	0.0	0.0	0.0	0.0	0.0
Total Lost Time (s)	5.0	5.6	5.0	5.6	5.6	6.4	6.1	6.1	6.4	6.1	6.1
Lead/Lag	Lead	Lag	Lead	Lag	Lag	Lead	Lag	Lag	Lead	Lag	Lag
Lead-Lag Optimize?	Yes	Yes	Yes	Yes	Yes	Yes	Yes	Yes	Yes	Yes	Yes
Recall Mode	None	None	None	None	None	None	C-Max	C-Max	None	C-Max	C-Max

Intersection Summary

Cycle Length: 110
 Actuated Cycle Length: 110
 Offset: 8 (7%), Referenced to phase 2:SBTL and 6:NBTL, Start of Green
 Natural Cycle: 90
 Control Type: Actuated-Coordinated

Splits and Phases: 1: Scottsdale Rd. & Ashler Hills Dr.



21-0480 Ashler Hills
2022 Existing AM

1: Scottsdale Rd. & Ashler Hills Dr.
HCM 6th Signalized Intersection Summary

Movement	EBL	EBT	EBR	WBL	WBT	WBR	NBL	NBT	NBR	SBL	SBT	SBR
Lane Configurations												
Traffic Volume (veh/h)	35	6	105	71	2	13	94	689	70	7	675	27
Future Volume (veh/h)	35	6	105	71	2	13	94	689	70	7	675	27
Initial Q (Qb), veh	0	0	0	0	0	0	0	0	0	0	0	0
Ped-Bike Adj(A_pbT)	1.00		1.00	1.00		1.00	1.00		1.00	1.00		1.00
Parking Bus, Adj	1.00	1.00	1.00	1.00	1.00	1.00	1.00	1.00	1.00	1.00	1.00	1.00
Work Zone On Approach		No			No			No			No	
Adj Sat Flow, veh/h/ln	1870	1870	1870	1870	1870	1870	1870	1870	1870	1870	1870	1870
Adj Flow Rate, veh/h	38	7	86	77	2	6	102	749	38	8	734	14
Peak Hour Factor	0.92	0.92	0.92	0.92	0.92	0.92	0.92	0.92	0.92	0.92	0.92	0.92
Percent Heavy Veh, %	2	2	2	2	2	2	2	2	2	2	2	2
Cap, veh/h	228	9	112	183	181	154	513	2317	1034	468	2198	980
Arrive On Green	0.03	0.08	0.08	0.05	0.10	0.10	0.04	0.65	0.65	0.01	0.62	0.62
Sat Flow, veh/h	1781	121	1483	1781	1870	1585	1781	3554	1585	1781	3554	1585
Grp Volume(v), veh/h	38	0	93	77	2	6	102	749	38	8	734	14
Grp Sat Flow(s),veh/h/ln	1781	0	1603	1781	1870	1585	1781	1777	1585	1781	1777	1585
Q Serve(g_s), s	2.1	0.0	6.3	4.3	0.1	0.4	2.3	10.2	0.9	0.2	10.9	0.4
Cycle Q Clear(g_c), s	2.1	0.0	6.3	4.3	0.1	0.4	2.3	10.2	0.9	0.2	10.9	0.4
Prop In Lane	1.00		0.92	1.00		1.00	1.00		1.00	1.00		1.00
Lane Grp Cap(c), veh/h	228	0	122	183	181	154	513	2317	1034	468	2198	980
V/C Ratio(X)	0.17	0.00	0.76	0.42	0.01	0.04	0.20	0.32	0.04	0.02	0.33	0.01
Avail Cap(c_a), veh/h	334	0	283	252	330	280	656	2317	1034	670	2198	980
HCM Platoon Ratio	1.00	1.00	1.00	1.00	1.00	1.00	1.00	1.00	1.00	1.00	1.00	1.00
Upstream Filter(I)	1.00	0.00	1.00	1.00	1.00	1.00	1.00	1.00	1.00	1.00	1.00	1.00
Uniform Delay (d), s/veh	44.8	0.0	49.9	43.9	44.9	45.0	7.3	8.4	6.8	7.8	10.1	8.1
Incr Delay (d2), s/veh	0.1	0.0	3.7	0.6	0.0	0.0	0.1	0.4	0.1	0.0	0.4	0.0
Initial Q Delay(d3),s/veh	0.0	0.0	0.0	0.0	0.0	0.0	0.0	0.0	0.0	0.0	0.0	0.0
%ile BackOfQ(50%),veh/ln	1.0	0.0	2.6	1.9	0.0	0.2	0.8	3.8	0.3	0.1	4.2	0.1
Unsig. Movement Delay, s/veh												
LnGrp Delay(d),s/veh	44.9	0.0	53.6	44.5	44.9	45.1	7.4	8.8	6.9	7.8	10.5	8.1
LnGrp LOS	D	A	D	D	D	D	A	A	A	A	B	A
Approach Vol, veh/h		131			85			889			756	
Approach Delay, s/veh		51.1			44.5			8.6			10.4	
Approach LOS		D			D			A			B	
Timer - Assigned Phs	1	2	3	4	5	6	7	8				
Phs Duration (G+Y+Rc), s	11.2	74.1	8.4	16.3	7.5	77.8	10.8	13.9				
Change Period (Y+Rc), s	6.4	6.1	5.0	5.6	6.4	6.1	5.0	5.6				
Max Green Setting (Gmax), s	13.6	43.9	10.0	19.4	13.6	43.9	10.0	19.4				
Max Q Clear Time (g_c+I1), s	4.3	12.9	4.1	2.4	2.2	12.2	6.3	8.3				
Green Ext Time (p_c), s	0.1	3.7	0.0	0.0	0.0	3.9	0.0	0.2				
Intersection Summary												
HCM 6th Ctrl Delay			14.0									
HCM 6th LOS			B									
Notes												
User approved pedestrian interval to be less than phase max green.												



Lane Group	EBL	EBT	WBL	WBT	WBR	NBL	NBT	NBR	SBL	SBT	SBR
Lane Configurations	↖	↗	↖	↗	↗	↖	↗	↗	↖	↗	↗
Traffic Volume (vph)	18	8	250	13	28	39	936	116	21	712	10
Future Volume (vph)	18	8	250	13	28	39	936	116	21	712	10
Turn Type	pm+pt	NA	pm+pt	NA	Perm	pm+pt	NA	Perm	pm+pt	NA	Perm
Protected Phases	3	8	7	4		1	6		5	2	
Permitted Phases	8		4		4	6		6	2		2
Detector Phase	3	8	7	4	4	1	6	6	5	2	2
Switch Phase											
Minimum Initial (s)	5.0	7.0	5.0	7.0	7.0	5.0	10.0	10.0	5.0	10.0	10.0
Minimum Split (s)	10.0	36.6	10.0	34.6	34.6	11.4	27.1	27.1	11.4	22.1	22.1
Total Split (s)	15.0	25.0	15.0	25.0	25.0	20.0	50.0	50.0	20.0	50.0	50.0
Total Split (%)	13.6%	22.7%	13.6%	22.7%	22.7%	18.2%	45.5%	45.5%	18.2%	45.5%	45.5%
Yellow Time (s)	3.0	3.3	3.0	3.3	3.3	4.4	5.1	5.1	4.4	5.1	5.1
All-Red Time (s)	2.0	2.3	2.0	2.3	2.3	2.0	1.0	1.0	2.0	1.0	1.0
Lost Time Adjust (s)	0.0	0.0	0.0	0.0	0.0	0.0	0.0	0.0	0.0	0.0	0.0
Total Lost Time (s)	5.0	5.6	5.0	5.6	5.6	6.4	6.1	6.1	6.4	6.1	6.1
Lead/Lag	Lead	Lag	Lead	Lag	Lag	Lead	Lag	Lag	Lead	Lag	Lag
Lead-Lag Optimize?	Yes	Yes	Yes	Yes	Yes	Yes	Yes	Yes	Yes	Yes	Yes
Recall Mode	None	None	None	None	None	None	C-Max	C-Max	None	C-Max	C-Max

Intersection Summary

Cycle Length: 110
 Actuated Cycle Length: 110
 Offset: 8 (7%), Referenced to phase 2:SBTL and 6:NBTL, Start of Green
 Natural Cycle: 90
 Control Type: Actuated-Coordinated

Splits and Phases: 1: Scottsdale Rd. & Ashler Hills Dr.



21-0480 Ashler Hills
2022 Existing PM

1: Scottsdale Rd. & Ashler Hills Dr.
HCM 6th Signalized Intersection Summary

Movement	EBL	EBT	EBR	WBL	WBT	WBR	NBL	NBT	NBR	SBL	SBT	SBR
Lane Configurations												
Traffic Volume (veh/h)	18	8	36	250	13	28	39	936	116	21	712	10
Future Volume (veh/h)	18	8	36	250	13	28	39	936	116	21	712	10
Initial Q (Qb), veh	0	0	0	0	0	0	0	0	0	0	0	0
Ped-Bike Adj(A_pbT)	1.00		1.00	1.00		1.00	1.00		1.00	1.00		1.00
Parking Bus, Adj	1.00	1.00	1.00	1.00	1.00	1.00	1.00	1.00	1.00	1.00	1.00	1.00
Work Zone On Approach		No			No			No			No	
Adj Sat Flow, veh/h/ln	1870	1870	1870	1870	1870	1870	1870	1870	1870	1870	1870	1870
Adj Flow Rate, veh/h	20	9	29	272	14	15	42	1017	63	23	774	6
Peak Hour Factor	0.92	0.92	0.92	0.92	0.92	0.92	0.92	0.92	0.92	0.92	0.92	0.92
Percent Heavy Veh, %	2	2	2	2	2	2	2	2	2	2	2	2
Cap, veh/h	184	23	74	278	242	205	469	2193	978	348	2157	962
Arrive On Green	0.02	0.06	0.06	0.09	0.13	0.13	0.03	0.62	0.62	0.02	0.61	0.61
Sat Flow, veh/h	1781	389	1255	1781	1870	1585	1781	3554	1585	1781	3554	1585
Grp Volume(v), veh/h	20	0	38	272	14	15	42	1017	63	23	774	6
Grp Sat Flow(s),veh/h/ln	1781	0	1644	1781	1870	1585	1781	1777	1585	1781	1777	1585
Q Serve(g_s), s	1.1	0.0	2.4	10.0	0.7	0.9	1.0	16.9	1.7	0.5	12.0	0.2
Cycle Q Clear(g_c), s	1.1	0.0	2.4	10.0	0.7	0.9	1.0	16.9	1.7	0.5	12.0	0.2
Prop In Lane	1.00		0.76	1.00		1.00	1.00		1.00	1.00		1.00
Lane Grp Cap(c), veh/h	184	0	97	278	242	205	469	2193	978	348	2157	962
V/C Ratio(X)	0.11	0.00	0.39	0.98	0.06	0.07	0.09	0.46	0.06	0.07	0.36	0.01
Avail Cap(c_a), veh/h	309	0	290	278	330	280	630	2193	978	528	2157	962
HCM Platoon Ratio	1.00	1.00	1.00	1.00	1.00	1.00	1.00	1.00	1.00	1.00	1.00	1.00
Upstream Filter(I)	1.00	0.00	1.00	1.00	1.00	1.00	1.00	1.00	1.00	1.00	1.00	1.00
Uniform Delay (d), s/veh	47.1	0.0	49.8	46.6	42.0	42.1	8.0	11.3	8.4	8.8	10.9	8.5
Incr Delay (d2), s/veh	0.1	0.0	0.9	47.7	0.0	0.1	0.0	0.7	0.1	0.0	0.5	0.0
Initial Q Delay(d3),s/veh	0.0	0.0	0.0	0.0	0.0	0.0	0.0	0.0	0.0	0.0	0.0	0.0
%ile BackOfQ(50%),veh/ln	0.5	0.0	1.0	6.3	0.3	0.4	0.4	6.5	0.6	0.2	4.7	0.1
Unsig. Movement Delay, s/veh												
LnGrp Delay(d),s/veh	47.2	0.0	50.8	94.3	42.0	42.2	8.0	12.0	8.5	8.8	11.3	8.5
LnGrp LOS	D	A	D	F	D	D	A	B	A	A	B	A
Approach Vol, veh/h		58			301			1122			803	
Approach Delay, s/veh		49.5			89.3			11.7			11.2	
Approach LOS		D			F			B			B	
Timer - Assigned Phs	1	2	3	4	5	6	7	8				
Phs Duration (G+Y+Rc), s	10.0	72.9	7.3	19.8	8.9	74.0	15.0	12.1				
Change Period (Y+Rc), s	6.4	6.1	5.0	5.6	6.4	6.1	5.0	5.6				
Max Green Setting (Gmax), s	13.6	43.9	10.0	19.4	13.6	43.9	10.0	19.4				
Max Q Clear Time (g_c+I1), s	3.0	14.0	3.1	2.9	2.5	18.9	12.0	4.4				
Green Ext Time (p_c), s	0.0	4.0	0.0	0.0	0.0	5.5	0.0	0.1				
Intersection Summary												
HCM 6th Ctrl Delay			22.7									
HCM 6th LOS			C									
Notes												
User approved pedestrian interval to be less than phase max green.												

Lane Group	EBL	EBT	WBL	WBT	WBR	NBL	NBT	NBR	SBL	SBT	SBR
Lane Configurations											
Traffic Volume (vph)	13	8	236	13	32	57	938	160	35	787	12
Future Volume (vph)	13	8	236	13	32	57	938	160	35	787	12
Turn Type	pm+pt	NA	pm+pt	NA	Perm	pm+pt	NA	Perm	pm+pt	NA	Perm
Protected Phases	3	8	7	4		1	6		5	2	
Permitted Phases	8		4		4	6		6	2		2
Detector Phase	3	8	7	4	4	1	6	6	5	2	2
Switch Phase											
Minimum Initial (s)	5.0	7.0	5.0	7.0	7.0	5.0	10.0	10.0	5.0	10.0	10.0
Minimum Split (s)	10.0	36.6	10.0	34.6	34.6	11.4	27.1	27.1	11.4	22.1	22.1
Total Split (s)	15.0	25.0	15.0	25.0	25.0	20.0	50.0	50.0	20.0	50.0	50.0
Total Split (%)	13.6%	22.7%	13.6%	22.7%	22.7%	18.2%	45.5%	45.5%	18.2%	45.5%	45.5%
Yellow Time (s)	3.0	3.3	3.0	3.3	3.3	4.4	5.1	5.1	4.4	5.1	5.1
All-Red Time (s)	2.0	2.3	2.0	2.3	2.3	2.0	1.0	1.0	2.0	1.0	1.0
Lost Time Adjust (s)	0.0	0.0	0.0	0.0	0.0	0.0	0.0	0.0	0.0	0.0	0.0
Total Lost Time (s)	5.0	5.6	5.0	5.6	5.6	6.4	6.1	6.1	6.4	6.1	6.1
Lead/Lag	Lead	Lag	Lead	Lag	Lag	Lead	Lag	Lag	Lead	Lag	Lag
Lead-Lag Optimize?	Yes	Yes	Yes	Yes	Yes	Yes	Yes	Yes	Yes	Yes	Yes
Recall Mode	None	None	None	None	None	None	C-Max	C-Max	None	C-Max	C-Max

Intersection Summary

Cycle Length: 110
 Actuated Cycle Length: 110
 Offset: 8 (7%), Referenced to phase 2:SBTL and 6:NBTL, Start of Green
 Natural Cycle: 90
 Control Type: Actuated-Coordinated

Splits and Phases: 1: Scottsdale Rd. & Ashler Hills Dr.

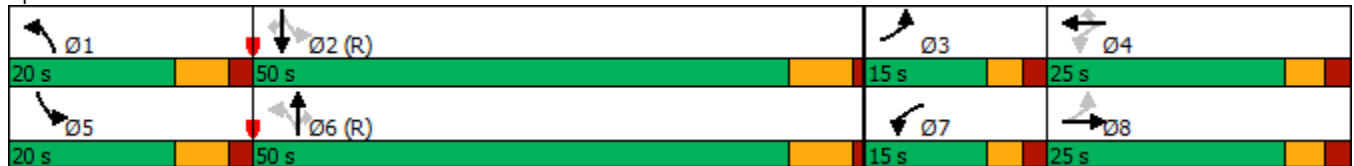

21-0480 Ashler Hills
2022 Existing SAT

1: Scottsdale Rd. & Ashler Hills Dr.
HCM 6th Signalized Intersection Summary



Movement	EBL	EBT	EBR	WBL	WBT	WBR	NBL	NBT	NBR	SBL	SBT	SBR
Lane Configurations												
Traffic Volume (veh/h)	13	8	46	236	13	32	57	938	160	35	787	12
Future Volume (veh/h)	13	8	46	236	13	32	57	938	160	35	787	12
Initial Q (Qb), veh	0	0	0	0	0	0	0	0	0	0	0	0
Ped-Bike Adj(A_pbT)	1.00		1.00	1.00		1.00	1.00		1.00	1.00		1.00
Parking Bus, Adj	1.00	1.00	1.00	1.00	1.00	1.00	1.00	1.00	1.00	1.00	1.00	1.00
Work Zone On Approach		No			No			No			No	
Adj Sat Flow, veh/h/ln	1870	1870	1870	1870	1870	1870	1870	1870	1870	1870	1870	1870
Adj Flow Rate, veh/h	14	9	38	257	14	18	62	1020	87	38	855	6
Peak Hour Factor	0.92	0.92	0.92	0.92	0.92	0.92	0.92	0.92	0.92	0.92	0.92	0.92
Percent Heavy Veh, %	2	2	2	2	2	2	2	2	2	2	2	2
Cap, veh/h	176	19	79	271	253	214	439	2160	964	350	2134	952
Arrive On Green	0.02	0.06	0.06	0.09	0.14	0.14	0.04	0.61	0.61	0.03	0.60	0.60
Sat Flow, veh/h	1781	313	1320	1781	1870	1585	1781	3554	1585	1781	3554	1585
Grp Volume(v), veh/h	14	0	47	257	14	18	62	1020	87	38	855	6
Grp Sat Flow(s),veh/h/ln	1781	0	1633	1781	1870	1585	1781	1777	1585	1781	1777	1585
Q Serve(g_s), s	0.8	0.0	3.1	10.0	0.7	1.1	1.4	17.4	2.5	0.9	13.9	0.2
Cycle Q Clear(g_c), s	0.8	0.0	3.1	10.0	0.7	1.1	1.4	17.4	2.5	0.9	13.9	0.2
Prop In Lane	1.00		0.81	1.00		1.00	1.00		1.00	1.00		1.00
Lane Grp Cap(c), veh/h	176	0	98	271	253	214	439	2160	964	350	2134	952
V/C Ratio(X)	0.08	0.00	0.48	0.95	0.06	0.08	0.14	0.47	0.09	0.11	0.40	0.01
Avail Cap(c_a), veh/h	310	0	288	271	330	280	590	2160	964	515	2134	952
HCM Platoon Ratio	1.00	1.00	1.00	1.00	1.00	1.00	1.00	1.00	1.00	1.00	1.00	1.00
Upstream Filter(I)	1.00	0.00	1.00	1.00	1.00	1.00	1.00	1.00	1.00	1.00	1.00	1.00
Uniform Delay (d), s/veh	47.4	0.0	50.0	46.1	41.5	41.6	8.4	11.9	8.9	9.0	11.6	8.8
Incr Delay (d2), s/veh	0.1	0.0	1.4	40.4	0.0	0.1	0.1	0.7	0.2	0.1	0.6	0.0
Initial Q Delay(d3),s/veh	0.0	0.0	0.0	0.0	0.0	0.0	0.0	0.0	0.0	0.0	0.0	0.0
%ile BackOfQ(50%),veh/ln	0.4	0.0	1.3	5.2	0.3	0.4	0.5	6.7	0.9	0.3	5.4	0.1
Unsig. Movement Delay, s/veh												
LnGrp Delay(d),s/veh	47.4	0.0	51.4	86.5	41.5	41.7	8.4	12.6	9.1	9.0	12.1	8.8
LnGrp LOS	D	A	D	F	D	D	A	B	A	A	B	A
Approach Vol, veh/h		61			289			1169			899	
Approach Delay, s/veh		50.5			81.6			12.1			12.0	
Approach LOS		D			F			B			B	
Timer - Assigned Phs	1	2	3	4	5	6	7	8				
Phs Duration (G+Y+Rc), s	10.6	72.2	6.7	20.5	9.8	73.0	15.0	12.2				
Change Period (Y+Rc), s	6.4	6.1	5.0	5.6	6.4	6.1	5.0	5.6				
Max Green Setting (Gmax), s	13.6	43.9	10.0	19.4	13.6	43.9	10.0	19.4				
Max Q Clear Time (g_c+I1), s	3.4	15.9	2.8	3.1	2.9	19.4	12.0	5.1				
Green Ext Time (p_c), s	0.0	4.4	0.0	0.0	0.0	5.6	0.0	0.1				

Intersection Summary

HCM 6th Ctrl Delay	21.3
HCM 6th LOS	C

Notes

User approved pedestrian interval to be less than phase max green.



Lane Group	EBL	EBT	WBL	WBT	WBR	NBL	NBT	NBR	SBL	SBT	SBR
Lane Configurations											
Traffic Volume (vph)	35	6	82	3	33	94	689	76	16	675	27
Future Volume (vph)	35	6	82	3	33	94	689	76	16	675	27
Turn Type	pm+pt	NA	pm+pt	NA	Perm	pm+pt	NA	Perm	pm+pt	NA	Perm
Protected Phases	3	8	7	4		1	6		5	2	
Permitted Phases	8		4		4	6		6	2		2
Detector Phase	3	8	7	4	4	1	6	6	5	2	2
Switch Phase											
Minimum Initial (s)	5.0	10.0	5.0	7.0	7.0	5.0	10.0	10.0	5.0	10.0	10.0
Minimum Split (s)	10.0	36.6	10.0	34.6	34.6	11.4	27.1	27.1	11.4	22.1	22.1
Total Split (s)	10.0	39.0	12.0	41.0	41.0	20.0	56.0	56.0	13.0	49.0	49.0
Total Split (%)	8.3%	32.5%	10.0%	34.2%	34.2%	16.7%	46.7%	46.7%	10.8%	40.8%	40.8%
Yellow Time (s)	3.0	3.3	3.0	3.3	3.3	4.4	5.1	5.1	4.4	5.1	5.1
All-Red Time (s)	2.0	2.3	2.0	2.3	2.3	2.0	1.0	1.0	2.0	1.0	1.0
Lost Time Adjust (s)	0.0	0.0	0.0	0.0	0.0	0.0	0.0	0.0	0.0	0.0	0.0
Total Lost Time (s)	5.0	5.6	5.0	5.6	5.6	6.4	6.1	6.1	6.4	6.1	6.1
Lead/Lag	Lead	Lag	Lead	Lag	Lag	Lead	Lag	Lag	Lead	Lag	Lag
Lead-Lag Optimize?	Yes	Yes	Yes	Yes	Yes	Yes	Yes	Yes	Yes	Yes	Yes
Recall Mode	None	None	None	None	None	None	C-Max	C-Max	None	C-Max	C-Max

Intersection Summary























Cycle Length: 120
 Actuated Cycle Length: 120
 Offset: 8 (7%), Referenced to phase 2:SBTL and 6:NBTL, Start of Green
 Natural Cycle: 90
 Control Type: Actuated-Coordinated

Splits and Phases: 1: Scottsdale Rd. & Ashler Hills Dr.



21-0480 Ashler Hills
2022 Background AM

1: Scottsdale Rd. & Ashler Hills Dr.
HCM 6th Signalized Intersection Summary

												
Movement	EBL	EBT	EBR	WBL	WBT	WBR	NBL	NBT	NBR	SBL	SBT	SBR
Lane Configurations												
Traffic Volume (veh/h)	35	6	105	82	3	33	94	689	76	16	675	27
Future Volume (veh/h)	35	6	105	82	3	33	94	689	76	16	675	27
Initial Q (Qb), veh	0	0	0	0	0	0	0	0	0	0	0	0
Ped-Bike Adj(A_pbT)	1.00		1.00	1.00		1.00	1.00		1.00	1.00		1.00
Parking Bus, Adj	1.00	1.00	1.00	1.00	1.00	1.00	1.00	1.00	1.00	1.00	1.00	1.00
Work Zone On Approach		No			No			No			No	
Adj Sat Flow, veh/h/ln	1870	1870	1870	1870	1870	1870	1870	1870	1870	1870	1870	1870
Adj Flow Rate, veh/h	38	7	86	89	3	18	102	749	42	17	734	14
Peak Hour Factor	0.92	0.92	0.92	0.92	0.92	0.92	0.92	0.92	0.92	0.92	0.92	0.92
Percent Heavy Veh, %	2	2	2	2	2	2	2	2	2	2	2	2
Cap, veh/h	228	10	123	198	208	176	509	2304	1028	472	2225	992
Arrive On Green	0.03	0.08	0.08	0.06	0.11	0.11	0.04	0.65	0.65	0.02	0.63	0.63
Sat Flow, veh/h	1781	121	1483	1781	1870	1585	1781	3554	1585	1781	3554	1585
Grp Volume(v), veh/h	38	0	93	89	3	18	102	749	42	17	734	14
Grp Sat Flow(s),veh/h/ln	1781	0	1603	1781	1870	1585	1781	1777	1585	1781	1777	1585
Q Serve(g_s), s	2.3	0.0	6.8	5.4	0.2	1.2	2.4	11.3	1.1	0.4	11.7	0.4
Cycle Q Clear(g_c), s	2.3	0.0	6.8	5.4	0.2	1.2	2.4	11.3	1.1	0.4	11.7	0.4
Prop In Lane	1.00		0.92	1.00		1.00	1.00		1.00	1.00		1.00
Lane Grp Cap(c), veh/h	228	0	133	198	208	176	509	2304	1028	472	2225	992
V/C Ratio(X)	0.17	0.00	0.70	0.45	0.01	0.10	0.20	0.33	0.04	0.04	0.33	0.01
Avail Cap(c_a), veh/h	249	0	446	198	552	468	639	2304	1028	538	2225	992
HCM Platoon Ratio	1.00	1.00	1.00	1.00	1.00	1.00	1.00	1.00	1.00	1.00	1.00	1.00
Upstream Filter(I)	1.00	0.00	1.00	1.00	1.00	1.00	1.00	1.00	1.00	1.00	1.00	1.00
Uniform Delay (d), s/veh	48.3	0.0	53.6	46.4	47.5	47.9	7.7	9.4	7.6	8.0	10.6	8.5
Incr Delay (d2), s/veh	0.1	0.0	2.5	0.6	0.0	0.1	0.1	0.4	0.1	0.0	0.4	0.0
Initial Q Delay(d3),s/veh	0.0	0.0	0.0	0.0	0.0	0.0	0.0	0.0	0.0	0.0	0.0	0.0
%ile BackOfQ(50%),veh/ln	1.0	0.0	2.8	2.4	0.1	0.5	0.9	4.3	0.4	0.2	4.5	0.1
Unsig. Movement Delay, s/veh												
LnGrp Delay(d),s/veh	48.4	0.0	56.1	47.0	47.5	48.0	7.8	9.8	7.7	8.0	11.0	8.5
LnGrp LOS	D	A	E	D	D	D	A	A	A	A	B	A
Approach Vol, veh/h		131			110			893			765	
Approach Delay, s/veh		53.8			47.2			9.5			10.9	
Approach LOS		D			D			A			B	
Timer - Assigned Phs	1	2	3	4	5	6	7	8				
Phs Duration (G+Y+Rc), s	11.2	81.2	8.6	18.9	8.6	83.9	12.0	15.5				
Change Period (Y+Rc), s	6.4	6.1	5.0	5.6	6.4	6.1	5.0	5.6				
Max Green Setting (Gmax), s	13.6	42.9	5.0	35.4	6.6	49.9	7.0	33.4				
Max Q Clear Time (g_c+I1), s	4.4	13.7	4.3	3.2	2.4	13.3	7.4	8.8				
Green Ext Time (p_c), s	0.1	3.7	0.0	0.0	0.0	3.9	0.0	0.3				
Intersection Summary												
HCM 6th Ctrl Delay			15.3									
HCM 6th LOS			B									
Notes												
User approved pedestrian interval to be less than phase max green.												



Lane Group	EBL	EBT	WBL	WBT	WBR	NBL	NBT	NBR	SBL	SBT	SBR
Lane Configurations											
Traffic Volume (vph)	18	9	259	14	44	39	936	127	41	712	10
Future Volume (vph)	18	9	259	14	44	39	936	127	41	712	10
Turn Type	pm+pt	NA	pm+pt	NA	Perm	pm+pt	NA	Perm	pm+pt	NA	Perm
Protected Phases	3	8	7	4		1	6		5	2	
Permitted Phases	8		4		4	6		6	2		2
Detector Phase	3	8	7	4	4	1	6	6	5	2	2
Switch Phase											
Minimum Initial (s)	5.0	10.0	5.0	7.0	7.0	5.0	10.0	10.0	5.0	10.0	10.0
Minimum Split (s)	10.0	36.6	10.0	34.6	34.6	11.4	27.1	27.1	11.4	22.1	22.1
Total Split (s)	14.4	36.6	22.4	44.6	44.6	11.4	49.0	49.0	12.0	49.6	49.6
Total Split (%)	12.0%	30.5%	18.7%	37.2%	37.2%	9.5%	40.8%	40.8%	10.0%	41.3%	41.3%
Yellow Time (s)	3.0	3.3	3.0	3.3	3.3	4.4	5.1	5.1	4.4	5.1	5.1
All-Red Time (s)	2.0	2.3	2.0	2.3	2.3	2.0	1.0	1.0	2.0	1.0	1.0
Lost Time Adjust (s)	0.0	0.0	0.0	0.0	0.0	0.0	0.0	0.0	0.0	0.0	0.0
Total Lost Time (s)	5.0	5.6	5.0	5.6	5.6	6.4	6.1	6.1	6.4	6.1	6.1
Lead/Lag	Lead	Lag	Lead	Lag	Lag	Lead	Lag	Lag	Lead	Lag	Lag
Lead-Lag Optimize?	Yes	Yes	Yes	Yes	Yes	Yes	Yes	Yes	Yes	Yes	Yes
Recall Mode	None	None	None	None	None	None	C-Max	C-Max	None	C-Max	C-Max

Intersection Summary

Cycle Length: 120
 Actuated Cycle Length: 120
 Offset: 0 (0%), Referenced to phase 2:SBTL and 6:NBTL, Start of Green
 Natural Cycle: 90
 Control Type: Actuated-Coordinated

Splits and Phases: 1: Scottsdale Rd. & Ashler Hills Dr.

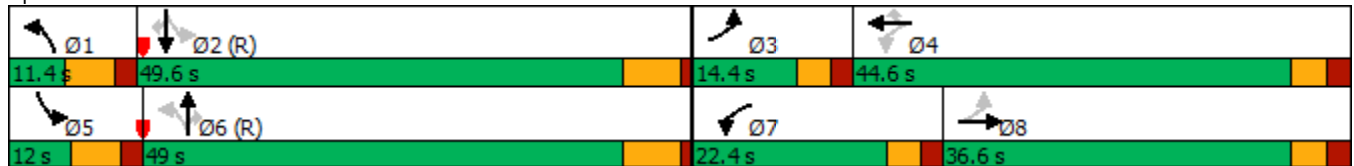



Movement	EBL	EBT	EBR	WBL	WBT	WBR	NBL	NBT	NBR	SBL	SBT	SBR
Lane Configurations	↖	↗		↖	↖	↖	↖	↑↑	↖	↖	↑↑	↖
Traffic Volume (veh/h)	18	9	36	259	14	44	39	936	127	41	712	10
Future Volume (veh/h)	18	9	36	259	14	44	39	936	127	41	712	10
Initial Q (Qb), veh	0	0	0	0	0	0	0	0	0	0	0	0
Ped-Bike Adj(A_pbT)	1.00		1.00	1.00		1.00	1.00		1.00	1.00		1.00
Parking Bus, Adj	1.00	1.00	1.00	1.00	1.00	1.00	1.00	1.00	1.00	1.00	1.00	1.00
Work Zone On Approach		No			No			No			No	
Adj Sat Flow, veh/h/ln	1870	1870	1870	1870	1870	1870	1870	1870	1870	1870	1870	1870
Adj Flow Rate, veh/h	20	10	29	282	15	24	42	1017	68	45	774	6
Peak Hour Factor	0.92	0.92	0.92	0.92	0.92	0.92	0.92	0.92	0.92	0.92	0.92	0.92
Percent Heavy Veh, %	2	2	2	2	2	2	2	2	2	2	2	2
Cap, veh/h	206	34	98	397	383	325	411	1954	872	310	1958	873
Arrive On Green	0.02	0.08	0.08	0.14	0.20	0.20	0.03	0.55	0.55	0.03	0.55	0.55
Sat Flow, veh/h	1781	423	1227	1781	1870	1585	1781	3554	1585	1781	3554	1585
Grp Volume(v), veh/h	20	0	39	282	15	24	42	1017	68	45	774	6
Grp Sat Flow(s),veh/h/ln	1781	0	1650	1781	1870	1585	1781	1777	1585	1781	1777	1585
Q Serve(g_s), s	1.2	0.0	2.7	17.1	0.8	1.5	1.2	21.7	2.4	1.3	15.0	0.2
Cycle Q Clear(g_c), s	1.2	0.0	2.7	17.1	0.8	1.5	1.2	21.7	2.4	1.3	15.0	0.2
Prop In Lane	1.00		0.74	1.00		1.00	1.00		1.00	1.00		1.00
Lane Grp Cap(c), veh/h	206	0	132	397	383	325	411	1954	872	310	1958	873
V/C Ratio(X)	0.10	0.00	0.29	0.71	0.04	0.07	0.10	0.52	0.08	0.15	0.40	0.01
Avail Cap(c_a), veh/h	309	0	426	397	608	515	429	1954	872	335	1958	873
HCM Platoon Ratio	1.00	1.00	1.00	1.00	1.00	1.00	1.00	1.00	1.00	1.00	1.00	1.00
Upstream Filter(I)	1.00	0.00	1.00	1.00	1.00	1.00	1.00	1.00	1.00	1.00	1.00	1.00
Uniform Delay (d), s/veh	49.1	0.0	52.0	41.1	38.2	38.5	11.8	17.0	12.7	12.9	15.5	12.1
Incr Delay (d2), s/veh	0.1	0.0	0.5	5.0	0.0	0.0	0.0	1.0	0.2	0.1	0.6	0.0
Initial Q Delay(d3),s/veh	0.0	0.0	0.0	0.0	0.0	0.0	0.0	0.0	0.0	0.0	0.0	0.0
%ile BackOfQ(50%),veh/ln	0.6	0.0	1.1	8.0	0.4	0.6	0.5	8.9	0.9	0.5	6.1	0.1
Unsig. Movement Delay, s/veh												
LnGrp Delay(d),s/veh	49.2	0.0	52.5	46.1	38.3	38.6	11.8	18.0	12.9	13.0	16.1	12.2
LnGrp LOS	D	A	D	D	D	D	B	B	B	B	B	B
Approach Vol, veh/h		59			321			1127			825	
Approach Delay, s/veh		51.3			45.1			17.5			15.9	
Approach LOS		D			D			B			B	
Timer - Assigned Phs	1	2	3	4	5	6	7	8				
Phs Duration (G+Y+Rc), s	10.2	72.2	7.4	30.2	10.3	72.1	22.4	15.2				
Change Period (Y+Rc), s	6.4	6.1	5.0	5.6	6.4	6.1	5.0	5.6				
Max Green Setting (Gmax), s	5.0	43.5	9.4	39.0	5.6	42.9	17.4	31.0				
Max Q Clear Time (g_c+I1), s	3.2	17.0	3.2	3.5	3.3	23.7	19.1	4.7				
Green Ext Time (p_c), s	0.0	3.9	0.0	0.1	0.0	5.2	0.0	0.1				

Intersection Summary

HCM 6th Ctrl Delay			21.6									
HCM 6th LOS			C									

Notes

User approved pedestrian interval to be less than phase max green.



Lane Group	EBL	EBT	WBL	WBT	WBR	NBL	NBT	NBR	SBL	SBT	SBR
Lane Configurations	↖	↗	↖	↗	↗	↖	↑↑	↗	↖	↑↑	↗
Traffic Volume (vph)	13	9	247	14	51	57	938	170	53	787	12
Future Volume (vph)	13	9	247	14	51	57	938	170	53	787	12
Turn Type	pm+pt	NA	pm+pt	NA	Perm	pm+pt	NA	Perm	pm+pt	NA	Perm
Protected Phases	3	8	7	4		1	6		5	2	
Permitted Phases	8		4		4	6		6	2		2
Detector Phase	3	8	7	4	4	1	6	6	5	2	2
Switch Phase											
Minimum Initial (s)	5.0	10.0	5.0	7.0	7.0	5.0	10.0	10.0	5.0	10.0	10.0
Minimum Split (s)	10.0	36.6	10.0	34.6	34.6	11.4	27.1	27.1	11.4	22.1	22.1
Total Split (s)	18.0	41.4	22.0	45.4	45.4	12.2	44.0	44.0	12.6	44.4	44.4
Total Split (%)	15.0%	34.5%	18.3%	37.8%	37.8%	10.2%	36.7%	36.7%	10.5%	37.0%	37.0%
Yellow Time (s)	3.0	3.3	3.0	3.3	3.3	4.4	5.1	5.1	4.4	5.1	5.1
All-Red Time (s)	2.0	2.3	2.0	2.3	2.3	2.0	1.0	1.0	2.0	1.0	1.0
Lost Time Adjust (s)	0.0	0.0	0.0	0.0	0.0	0.0	0.0	0.0	0.0	0.0	0.0
Total Lost Time (s)	5.0	5.6	5.0	5.6	5.6	6.4	6.1	6.1	6.4	6.1	6.1
Lead/Lag	Lead	Lag	Lead	Lag	Lag	Lead	Lag	Lag	Lead	Lag	Lag
Lead-Lag Optimize?	Yes	Yes	Yes	Yes	Yes	Yes	Yes	Yes	Yes	Yes	Yes
Recall Mode	None	None	None	None	None	None	C-Max	C-Max	None	C-Max	C-Max

Intersection Summary





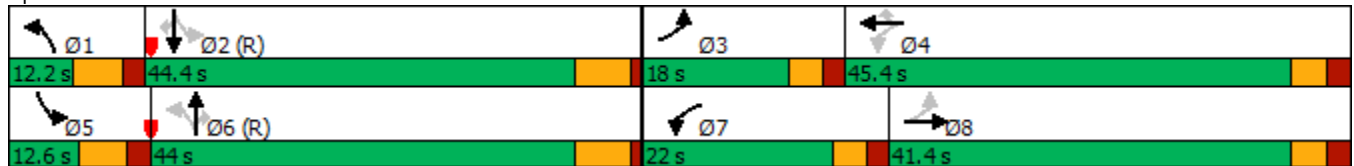

















Cycle Length: 120
 Actuated Cycle Length: 120
 Offset: 0 (0%), Referenced to phase 2:SBTL and 6:NBTL, Start of Green
 Natural Cycle: 90
 Control Type: Actuated-Coordinated

Splits and Phases: 1: Scottsdale Rd. & Ashler Hills Dr.



21-0480 Ashler Hills
2022 Background SAT

1: Scottsdale Rd. & Ashler Hills Dr.
HCM 6th Signalized Intersection Summary

												
Movement	EBL	EBT	EBR	WBL	WBT	WBR	NBL	NBT	NBR	SBL	SBT	SBR
Lane Configurations												
Traffic Volume (veh/h)	13	9	46	247	14	51	57	938	170	53	787	12
Future Volume (veh/h)	13	9	46	247	14	51	57	938	170	53	787	12
Initial Q (Qb), veh	0	0	0	0	0	0	0	0	0	0	0	0
Ped-Bike Adj(A_pbT)	1.00		1.00	1.00		1.00	1.00		1.00	1.00		1.00
Parking Bus, Adj	1.00	1.00	1.00	1.00	1.00	1.00	1.00	1.00	1.00	1.00	1.00	1.00
Work Zone On Approach		No			No			No			No	
Adj Sat Flow, veh/h/ln	1870	1870	1870	1870	1870	1870	1870	1870	1870	1870	1870	1870
Adj Flow Rate, veh/h	14	10	38	268	15	27	62	1020	93	58	855	6
Peak Hour Factor	0.92	0.92	0.92	0.92	0.92	0.92	0.92	0.92	0.92	0.92	0.92	0.92
Percent Heavy Veh, %	2	2	2	2	2	2	2	2	2	2	2	2
Cap, veh/h	198	28	105	384	387	328	385	1953	871	310	1950	870
Arrive On Green	0.02	0.08	0.08	0.14	0.21	0.21	0.04	0.55	0.55	0.04	0.55	0.55
Sat Flow, veh/h	1781	341	1296	1781	1870	1585	1781	3554	1585	1781	3554	1585
Grp Volume(v), veh/h	14	0	48	268	15	27	62	1020	93	58	855	6
Grp Sat Flow(s),veh/h/ln	1781	0	1637	1781	1870	1585	1781	1777	1585	1781	1777	1585
Q Serve(g_s), s	0.9	0.0	3.3	16.2	0.8	1.6	1.8	21.8	3.4	1.7	17.2	0.2
Cycle Q Clear(g_c), s	0.9	0.0	3.3	16.2	0.8	1.6	1.8	21.8	3.4	1.7	17.2	0.2
Prop In Lane	1.00		0.79	1.00		1.00	1.00		1.00	1.00		1.00
Lane Grp Cap(c), veh/h	198	0	132	384	387	328	385	1953	871	310	1950	870
V/C Ratio(X)	0.07	0.00	0.36	0.70	0.04	0.08	0.16	0.52	0.11	0.19	0.44	0.01
Avail Cap(c_a), veh/h	363	0	488	384	620	526	407	1953	871	338	1950	870
HCM Platoon Ratio	1.00	1.00	1.00	1.00	1.00	1.00	1.00	1.00	1.00	1.00	1.00	1.00
Upstream Filter(I)	1.00	0.00	1.00	1.00	1.00	1.00	1.00	1.00	1.00	1.00	1.00	1.00
Uniform Delay (d), s/veh	49.4	0.0	52.2	41.0	38.0	38.4	12.1	17.1	12.9	12.9	16.1	12.3
Incr Delay (d2), s/veh	0.1	0.0	0.6	4.6	0.0	0.0	0.1	1.0	0.2	0.1	0.7	0.0
Initial Q Delay(d3),s/veh	0.0	0.0	0.0	0.0	0.0	0.0	0.0	0.0	0.0	0.0	0.0	0.0
%ile BackOfQ(50%),veh/ln	0.4	0.0	1.4	7.6	0.4	0.6	0.7	8.9	1.3	0.7	7.0	0.1
Unsig. Movement Delay, s/veh												
LnGrp Delay(d),s/veh	49.4	0.0	52.9	45.7	38.1	38.4	12.1	18.1	13.2	13.0	16.8	12.3
LnGrp LOS	D	A	D	D	D	D	B	B	B	B	B	B
Approach Vol, veh/h		62			310			1175			919	
Approach Delay, s/veh		52.1			44.7			17.4			16.5	
Approach LOS		D			D			B			B	
Timer - Assigned Phs	1	2	3	4	5	6	7	8				
Phs Duration (G+Y+Rc), s	10.8	71.9	6.9	30.4	10.7	72.0	22.0	15.3				
Change Period (Y+Rc), s	6.4	6.1	5.0	5.6	6.4	6.1	5.0	5.6				
Max Green Setting (Gmax), s	5.8	38.3	13.0	39.8	6.2	37.9	17.0	35.8				
Max Q Clear Time (g_c+I1), s	3.8	19.2	2.9	3.6	3.7	23.8	18.2	5.3				
Green Ext Time (p_c), s	0.0	4.1	0.0	0.1	0.0	4.6	0.0	0.1				

Intersection Summary

HCM 6th Ctrl Delay	21.4
HCM 6th LOS	C

Notes

User approved pedestrian interval to be less than phase max green.

Intersection						
Int Delay, s/veh	0					
Movement	EBL	EBT	WBT	WBR	SBL	SBR
Lane Configurations						
Traffic Vol, veh/h	0	23	41	0	0	0
Future Vol, veh/h	0	23	41	0	0	0
Conflicting Peds, #/hr	0	0	0	0	0	0
Sign Control	Free	Free	Free	Free	Stop	Stop
RT Channelized	-	None	-	None	-	None
Storage Length	75	-	-	-	0	-
Veh in Median Storage, #	-	0	0	-	0	-
Grade, %	-	0	0	-	0	-
Peak Hour Factor	92	92	92	92	92	92
Heavy Vehicles, %	2	2	2	2	2	2
Mvmt Flow	0	25	45	0	0	0

Major/Minor	Major1	Major2	Minor2		
Conflicting Flow All	45	0	-	0	70
Stage 1	-	-	-	-	45
Stage 2	-	-	-	-	25
Critical Hdwy	4.12	-	-	-	6.42
Critical Hdwy Stg 1	-	-	-	-	5.42
Critical Hdwy Stg 2	-	-	-	-	5.42
Follow-up Hdwy	2.218	-	-	-	3.518
Pot Cap-1 Maneuver	1563	-	-	-	934
Stage 1	-	-	-	-	977
Stage 2	-	-	-	-	998
Platoon blocked, %		-	-	-	
Mov Cap-1 Maneuver	1563	-	-	-	934
Mov Cap-2 Maneuver	-	-	-	-	934
Stage 1	-	-	-	-	977
Stage 2	-	-	-	-	998

Approach	EB	WB	SB
HCM Control Delay, s	0	0	0
HCM LOS			A

Minor Lane/Major Mvmt	EBL	EBT	WBT	WBR	SBLn1
Capacity (veh/h)	1563	-	-	-	-
HCM Lane V/C Ratio	-	-	-	-	-
HCM Control Delay (s)	0	-	-	-	0
HCM Lane LOS	A	-	-	-	A
HCM 95th %tile Q(veh)	0	-	-	-	-

Intersection						
Int Delay, s/veh	0					
Movement	EBL	EBT	WBT	WBR	SBL	SBR
Lane Configurations						
Traffic Vol, veh/h	0	56	46	0	0	0
Future Vol, veh/h	0	56	46	0	0	0
Conflicting Peds, #/hr	0	0	0	0	0	0
Sign Control	Free	Free	Free	Free	Stop	Stop
RT Channelized	-	None	-	None	-	None
Storage Length	75	-	-	-	0	-
Veh in Median Storage, #	-	0	0	-	0	-
Grade, %	-	0	0	-	0	-
Peak Hour Factor	92	92	92	92	92	92
Heavy Vehicles, %	2	2	2	2	2	2
Mvmt Flow	0	61	50	0	0	0

Major/Minor	Major1	Major2	Minor2		
Conflicting Flow All	50	0	-	0	111 50
Stage 1	-	-	-	-	50 -
Stage 2	-	-	-	-	61 -
Critical Hdwy	4.12	-	-	-	6.42 6.22
Critical Hdwy Stg 1	-	-	-	-	5.42 -
Critical Hdwy Stg 2	-	-	-	-	5.42 -
Follow-up Hdwy	2.218	-	-	-	3.518 3.318
Pot Cap-1 Maneuver	1557	-	-	-	886 1018
Stage 1	-	-	-	-	972 -
Stage 2	-	-	-	-	962 -
Platoon blocked, %		-	-	-	
Mov Cap-1 Maneuver	1557	-	-	-	886 1018
Mov Cap-2 Maneuver	-	-	-	-	886 -
Stage 1	-	-	-	-	972 -
Stage 2	-	-	-	-	962 -

Approach	EB	WB	SB
HCM Control Delay, s	0	0	0
HCM LOS			A

Minor Lane/Major Mvmt	EBL	EBT	WBT	WBR	SBLn1
Capacity (veh/h)	1557	-	-	-	-
HCM Lane V/C Ratio	-	-	-	-	-
HCM Control Delay (s)	0	-	-	-	0
HCM Lane LOS	A	-	-	-	A
HCM 95th %tile Q(veh)	0	-	-	-	-

Intersection						
Int Delay, s/veh	0					
Movement	EBL	EBT	WBT	WBR	SBL	SBR
Lane Configurations						
Traffic Vol, veh/h	0	63	50	0	0	0
Future Vol, veh/h	0	63	50	0	0	0
Conflicting Peds, #/hr	0	0	0	0	0	0
Sign Control	Free	Free	Free	Free	Stop	Stop
RT Channelized	-	None	-	None	-	None
Storage Length	75	-	-	-	0	-
Veh in Median Storage, #	-	0	0	-	0	-
Grade, %	-	0	0	-	0	-
Peak Hour Factor	92	92	92	92	92	92
Heavy Vehicles, %	2	2	2	2	2	2
Mvmt Flow	0	68	54	0	0	0

Major/Minor	Major1	Major2	Minor2		
Conflicting Flow All	54	0	-	0	122 54
Stage 1	-	-	-	-	54 -
Stage 2	-	-	-	-	68 -
Critical Hdwy	4.12	-	-	-	6.42 6.22
Critical Hdwy Stg 1	-	-	-	-	5.42 -
Critical Hdwy Stg 2	-	-	-	-	5.42 -
Follow-up Hdwy	2.218	-	-	-	3.518 3.318
Pot Cap-1 Maneuver	1551	-	-	-	873 1013
Stage 1	-	-	-	-	969 -
Stage 2	-	-	-	-	955 -
Platoon blocked, %		-	-	-	
Mov Cap-1 Maneuver	1551	-	-	-	873 1013
Mov Cap-2 Maneuver	-	-	-	-	873 -
Stage 1	-	-	-	-	969 -
Stage 2	-	-	-	-	955 -

Approach	EB	WB	SB
HCM Control Delay, s	0	0	0
HCM LOS			A

Minor Lane/Major Mvmt	EBL	EBT	WBT	WBR	SBLn1
Capacity (veh/h)	1551	-	-	-	-
HCM Lane V/C Ratio	-	-	-	-	-
HCM Control Delay (s)	0	-	-	-	0
HCM Lane LOS	A	-	-	-	A
HCM 95th %tile Q(veh)	0	-	-	-	-

Lane Group	EBL	EBT	WBL	WBT	WBR	NBL	NBT	NBR	SBL	SBT	SBR
Lane Configurations											
Traffic Volume (vph)	35	7	86	3	38	94	689	91	37	675	27
Future Volume (vph)	35	7	86	3	38	94	689	91	37	675	27
Turn Type	pm+pt	NA	pm+pt	NA	Perm	pm+pt	NA	Perm	pm+pt	NA	Perm
Protected Phases	3	8	7	4		1	6		5	2	
Permitted Phases	8		4		4	6		6	2		2
Detector Phase	3	8	7	4	4	1	6	6	5	2	2
Switch Phase											
Minimum Initial (s)	5.0	10.0	5.0	7.0	7.0	5.0	10.0	10.0	5.0	10.0	10.0
Minimum Split (s)	10.0	36.6	10.0	34.6	34.6	11.4	27.1	27.1	11.4	22.1	22.1
Total Split (s)	10.0	39.0	12.0	41.0	41.0	20.0	56.0	56.0	13.0	49.0	49.0
Total Split (%)	8.3%	32.5%	10.0%	34.2%	34.2%	16.7%	46.7%	46.7%	10.8%	40.8%	40.8%
Yellow Time (s)	3.0	3.3	3.0	3.3	3.3	4.4	5.1	5.1	4.4	5.1	5.1
All-Red Time (s)	2.0	2.3	2.0	2.3	2.3	2.0	1.0	1.0	2.0	1.0	1.0
Lost Time Adjust (s)	0.0	0.0	0.0	0.0	0.0	0.0	0.0	0.0	0.0	0.0	0.0
Total Lost Time (s)	5.0	5.6	5.0	5.6	5.6	6.4	6.1	6.1	6.4	6.1	6.1
Lead/Lag	Lead	Lag	Lead	Lag	Lag	Lead	Lag	Lag	Lead	Lag	Lag
Lead-Lag Optimize?	Yes	Yes	Yes	Yes	Yes	Yes	Yes	Yes	Yes	Yes	Yes
Recall Mode	None	None	None	None	None	None	C-Max	C-Max	None	C-Max	C-Max
Act Effct Green (s)	15.9	10.3	20.9	16.1	16.1	82.0	76.7	76.7	78.3	73.2	73.2
Actuated g/C Ratio	0.13	0.09	0.17	0.13	0.13	0.68	0.64	0.64	0.65	0.61	0.61
v/c Ratio	0.19	0.51	0.48	0.01	0.11	0.21	0.33	0.09	0.09	0.34	0.03
Control Delay	42.7	18.8	50.8	48.3	0.6	6.5	11.0	1.0	5.8	12.3	0.0
Queue Delay	0.0	0.0	0.0	0.0	0.0	0.0	0.0	0.0	0.0	0.0	0.0
Total Delay	42.7	18.8	50.8	48.3	0.6	6.5	11.0	1.0	5.8	12.3	0.0
LOS	D	B	D	D	A	A	B	A	A	B	A
Approach Delay		24.5		35.7			9.4			11.5	
Approach LOS		C		D			A			B	

Intersection Summary

Cycle Length: 120
 Actuated Cycle Length: 120
 Offset: 8 (7%), Referenced to phase 2:SBTL and 6:NBTL, Start of Green
 Natural Cycle: 90
 Control Type: Actuated-Coordinated
 Maximum v/c Ratio: 0.51
 Intersection Signal Delay: 13.2
 Intersection Capacity Utilization 50.4%
 Analysis Period (min) 15
 Intersection LOS: B
 ICU Level of Service A

Splits and Phases: 1: Scottsdale Rd. & Ashler Hills Dr.

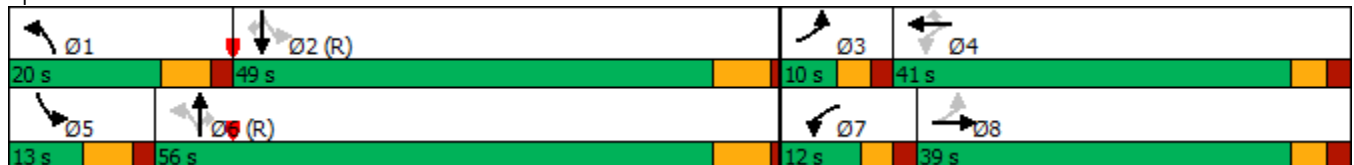

21-0480 Ashler Hills
2022 Total AM

1: Scottsdale Rd. & Ashler Hills Dr.
HCM 6th Signalized Intersection Summary

Movement	EBL	EBT	EBR	WBL	WBT	WBR	NBL	NBT	NBR	SBL	SBT	SBR
Lane Configurations												
Traffic Volume (veh/h)	35	7	105	86	3	38	94	689	91	37	675	27
Future Volume (veh/h)	35	7	105	86	3	38	94	689	91	37	675	27
Initial Q (Qb), veh	0	0	0	0	0	0	0	0	0	0	0	0
Ped-Bike Adj(A_pbT)	1.00		1.00	1.00		1.00	1.00		1.00	1.00		1.00
Parking Bus, Adj	1.00	1.00	1.00	1.00	1.00	1.00	1.00	1.00	1.00	1.00	1.00	1.00
Work Zone On Approach		No			No			No			No	
Adj Sat Flow, veh/h/ln	1870	1870	1870	1870	1870	1870	1870	1870	1870	1870	1870	1870
Adj Flow Rate, veh/h	38	8	86	93	3	20	102	749	50	40	734	14
Peak Hour Factor	0.92	0.92	0.92	0.92	0.92	0.92	0.92	0.92	0.92	0.92	0.92	0.92
Percent Heavy Veh, %	2	2	2	2	2	2	2	2	2	2	2	2
Cap, veh/h	228	11	122	198	208	176	509	2259	1007	481	2225	992
Arrive On Green	0.03	0.08	0.08	0.06	0.11	0.11	0.04	0.64	0.64	0.03	0.63	0.63
Sat Flow, veh/h	1781	137	1469	1781	1870	1585	1781	3554	1585	1781	3554	1585
Grp Volume(v), veh/h	38	0	94	93	3	20	102	749	50	40	734	14
Grp Sat Flow(s),veh/h/ln	1781	0	1606	1781	1870	1585	1781	1777	1585	1781	1777	1585
Q Serve(g_s), s	2.3	0.0	6.8	5.7	0.2	1.4	2.4	11.7	1.4	0.9	11.7	0.4
Cycle Q Clear(g_c), s	2.3	0.0	6.8	5.7	0.2	1.4	2.4	11.7	1.4	0.9	11.7	0.4
Prop In Lane	1.00		0.91	1.00		1.00	1.00		1.00	1.00		1.00
Lane Grp Cap(c), veh/h	228	0	133	198	208	176	509	2259	1007	481	2225	992
V/C Ratio(X)	0.17	0.00	0.71	0.47	0.01	0.11	0.20	0.33	0.05	0.08	0.33	0.01
Avail Cap(c_a), veh/h	249	0	447	198	552	468	639	2259	1007	524	2225	992
HCM Platoon Ratio	1.00	1.00	1.00	1.00	1.00	1.00	1.00	1.00	1.00	1.00	1.00	1.00
Upstream Filter(I)	1.00	0.00	1.00	1.00	1.00	1.00	1.00	1.00	1.00	1.00	1.00	1.00
Uniform Delay (d), s/veh	48.3	0.0	53.6	46.6	47.5	48.0	7.8	10.1	8.2	7.7	10.6	8.5
Incr Delay (d2), s/veh	0.1	0.0	2.6	0.6	0.0	0.1	0.1	0.4	0.1	0.0	0.4	0.0
Initial Q Delay(d3),s/veh	0.0	0.0	0.0	0.0	0.0	0.0	0.0	0.0	0.0	0.0	0.0	0.0
%ile BackOfQ(50%),veh/ln	1.0	0.0	2.9	2.5	0.1	0.5	0.9	4.5	0.5	0.4	4.5	0.1
Unsig. Movement Delay, s/veh												
LnGrp Delay(d),s/veh	48.4	0.0	56.2	47.2	47.5	48.1	7.8	10.5	8.3	7.8	11.0	8.5
LnGrp LOS	D	A	E	D	D	D	A	B	A	A	B	A
Approach Vol, veh/h		132			116			901			788	
Approach Delay, s/veh		53.9			47.4			10.1			10.8	
Approach LOS		D			D			B			B	
Timer - Assigned Phs	1	2	3	4	5	6	7	8				
Phs Duration (G+Y+Rc), s	11.2	81.2	8.6	19.0	10.1	82.4	12.0	15.5				
Change Period (Y+Rc), s	6.4	6.1	5.0	5.6	6.4	6.1	5.0	5.6				
Max Green Setting (Gmax), s	13.6	42.9	5.0	35.4	6.6	49.9	7.0	33.4				
Max Q Clear Time (g_c+I1), s	4.4	13.7	4.3	3.4	2.9	13.7	7.7	8.8				
Green Ext Time (p_c), s	0.1	3.7	0.0	0.0	0.0	3.9	0.0	0.3				

Intersection Summary

HCM 6th Ctrl Delay	15.6
HCM 6th LOS	B

Notes

User approved pedestrian interval to be less than phase max green.

Lane Group	EBL	EBT	WBL	WBT	WBR	NBL	NBT	NBR	SBL	SBT	SBR
Lane Configurations											
Traffic Volume (vph)	18	10	268	15	56	39	936	137	54	712	10
Future Volume (vph)	18	10	268	15	56	39	936	137	54	712	10
Turn Type	pm+pt	NA	pm+pt	NA	Perm	pm+pt	NA	Perm	pm+pt	NA	Perm
Protected Phases	3	8	7	4		1	6		5	2	
Permitted Phases	8		4		4	6		6	2		2
Detector Phase	3	8	7	4	4	1	6	6	5	2	2
Switch Phase											
Minimum Initial (s)	5.0	10.0	5.0	7.0	7.0	5.0	10.0	10.0	5.0	10.0	10.0
Minimum Split (s)	10.0	36.6	10.0	34.6	34.6	11.4	27.1	27.1	11.4	22.1	22.1
Total Split (s)	14.4	36.6	22.4	44.6	44.6	11.4	49.0	49.0	12.0	49.6	49.6
Total Split (%)	12.0%	30.5%	18.7%	37.2%	37.2%	9.5%	40.8%	40.8%	10.0%	41.3%	41.3%
Yellow Time (s)	3.0	3.3	3.0	3.3	3.3	4.4	5.1	5.1	4.4	5.1	5.1
All-Red Time (s)	2.0	2.3	2.0	2.3	2.3	2.0	1.0	1.0	2.0	1.0	1.0
Lost Time Adjust (s)	0.0	0.0	0.0	0.0	0.0	0.0	0.0	0.0	0.0	0.0	0.0
Total Lost Time (s)	5.0	5.6	5.0	5.6	5.6	6.4	6.1	6.1	6.4	6.1	6.1
Lead/Lag	Lead	Lag	Lead	Lag	Lag	Lead	Lag	Lag	Lead	Lag	Lag
Lead-Lag Optimize?	Yes	Yes	Yes	Yes	Yes	Yes	Yes	Yes	Yes	Yes	Yes
Recall Mode	None	None	None	None	None	None	C-Max	C-Max	None	C-Max	C-Max
Act Effct Green (s)	14.2	10.0	29.7	24.4	24.4	73.4	69.0	69.0	74.3	69.5	69.5
Actuated g/C Ratio	0.12	0.08	0.25	0.20	0.20	0.61	0.58	0.58	0.62	0.58	0.58
v/c Ratio	0.11	0.29	0.84	0.04	0.14	0.10	0.50	0.15	0.19	0.38	0.01
Control Delay	34.5	25.6	62.0	40.0	0.7	9.3	18.0	1.7	10.1	15.9	0.0
Queue Delay	0.0	0.0	0.0	0.0	0.0	0.0	0.0	0.0	0.0	0.0	0.0
Total Delay	34.5	25.6	62.0	40.0	0.7	9.3	18.0	1.7	10.1	15.9	0.0
LOS	C	C	E	D	A	A	B	A	B	B	A
Approach Delay		28.2		50.9			15.7			15.3	
Approach LOS		C		D			B			B	

Intersection Summary

Cycle Length: 120
 Actuated Cycle Length: 120
 Offset: 0 (0%), Referenced to phase 2:SBTL and 6:NBTL, Start of Green
 Natural Cycle: 90
 Control Type: Actuated-Coordinated
 Maximum v/c Ratio: 0.84
 Intersection Signal Delay: 21.1
 Intersection Capacity Utilization 66.6%
 Analysis Period (min) 15
 Intersection LOS: C
 ICU Level of Service C

Splits and Phases: 1: Scottsdale Rd. & Ashler Hills Dr.

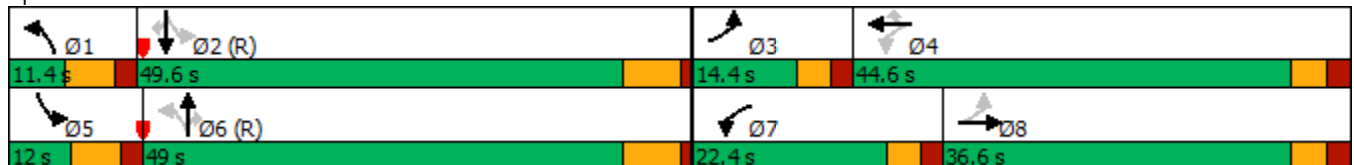

21-0480 Ashler Hills
2022 Total PM

1: Scottsdale Rd. & Ashler Hills Dr.
HCM 6th Signalized Intersection Summary

Movement	EBL	EBT	EBR	WBL	WBT	WBR	NBL	NBT	NBR	SBL	SBT	SBR
Lane Configurations												
Traffic Volume (veh/h)	18	10	36	268	15	56	39	936	137	54	712	10
Future Volume (veh/h)	18	10	36	268	15	56	39	936	137	54	712	10
Initial Q (Qb), veh	0	0	0	0	0	0	0	0	0	0	0	0
Ped-Bike Adj(A_pbT)	1.00		1.00	1.00		1.00	1.00		1.00	1.00		1.00
Parking Bus, Adj	1.00	1.00	1.00	1.00	1.00	1.00	1.00	1.00	1.00	1.00	1.00	1.00
Work Zone On Approach		No			No			No			No	
Adj Sat Flow, veh/h/ln	1870	1870	1870	1870	1870	1870	1870	1870	1870	1870	1870	1870
Adj Flow Rate, veh/h	20	11	29	291	16	31	42	1017	74	59	774	6
Peak Hour Factor	0.92	0.92	0.92	0.92	0.92	0.92	0.92	0.92	0.92	0.92	0.92	0.92
Percent Heavy Veh, %	2	2	2	2	2	2	2	2	2	2	2	2
Cap, veh/h	206	37	97	398	385	326	410	1939	865	312	1955	872
Arrive On Green	0.02	0.08	0.08	0.14	0.21	0.21	0.03	0.55	0.55	0.04	0.55	0.55
Sat Flow, veh/h	1781	455	1199	1781	1870	1585	1781	3554	1585	1781	3554	1585
Grp Volume(v), veh/h	20	0	40	291	16	31	42	1017	74	59	774	6
Grp Sat Flow(s),veh/h/ln	1781	0	1654	1781	1870	1585	1781	1777	1585	1781	1777	1585
Q Serve(g_s), s	1.2	0.0	2.7	17.4	0.8	1.9	1.2	21.9	2.7	1.7	15.0	0.2
Cycle Q Clear(g_c), s	1.2	0.0	2.7	17.4	0.8	1.9	1.2	21.9	2.7	1.7	15.0	0.2
Prop In Lane	1.00		0.73	1.00		1.00	1.00		1.00	1.00		1.00
Lane Grp Cap(c), veh/h	206	0	134	398	385	326	410	1939	865	312	1955	872
V/C Ratio(X)	0.10	0.00	0.30	0.73	0.04	0.10	0.10	0.52	0.09	0.19	0.40	0.01
Avail Cap(c_a), veh/h	310	0	427	398	608	515	428	1939	865	331	1955	872
HCM Platoon Ratio	1.00	1.00	1.00	1.00	1.00	1.00	1.00	1.00	1.00	1.00	1.00	1.00
Upstream Filter(I)	1.00	0.00	1.00	1.00	1.00	1.00	1.00	1.00	1.00	1.00	1.00	1.00
Uniform Delay (d), s/veh	49.0	0.0	51.9	41.3	38.2	38.6	11.9	17.3	13.0	13.1	15.5	12.2
Incr Delay (d2), s/veh	0.1	0.0	0.5	5.9	0.0	0.0	0.0	1.0	0.2	0.1	0.6	0.0
Initial Q Delay(d3),s/veh	0.0	0.0	0.0	0.0	0.0	0.0	0.0	0.0	0.0	0.0	0.0	0.0
%ile BackOfQ(50%),veh/ln	0.6	0.0	1.2	8.4	0.4	0.7	0.5	9.0	1.0	0.7	6.2	0.1
Unsig. Movement Delay, s/veh												
LnGrp Delay(d),s/veh	49.1	0.0	52.4	47.3	38.2	38.7	12.0	18.4	13.2	13.2	16.1	12.2
LnGrp LOS	D	A	D	D	D	D	B	B	B	B	B	B
Approach Vol, veh/h		60			338			1133			839	
Approach Delay, s/veh		51.3			46.1			17.8			15.9	
Approach LOS		D			D			B			B	
Timer - Assigned Phs	1	2	3	4	5	6	7	8				
Phs Duration (G+Y+Rc), s	10.2	72.1	7.4	30.3	10.7	71.6	22.4	15.3				
Change Period (Y+Rc), s	6.4	6.1	5.0	5.6	6.4	6.1	5.0	5.6				
Max Green Setting (Gmax), s	5.0	43.5	9.4	39.0	5.6	42.9	17.4	31.0				
Max Q Clear Time (g_c+I1), s	3.2	17.0	3.2	3.9	3.7	23.9	19.4	4.7				
Green Ext Time (p_c), s	0.0	3.9	0.0	0.1	0.0	5.2	0.0	0.1				
Intersection Summary												
HCM 6th Ctrl Delay			22.0									
HCM 6th LOS			C									
Notes												
User approved pedestrian interval to be less than phase max green.												

Lane Group	EBL	EBT	WBL	WBT	WBR	NBL	NBT	NBR	SBL	SBT	SBR
Lane Configurations											
Traffic Volume (vph)	13	10	254	15	61	57	938	190	80	787	12
Future Volume (vph)	13	10	254	15	61	57	938	190	80	787	12
Turn Type	pm+pt	NA	pm+pt	NA	Perm	pm+pt	NA	Perm	pm+pt	NA	Perm
Protected Phases	3	8	7	4		1	6		5	2	
Permitted Phases	8		4		4	6		6	2		2
Detector Phase	3	8	7	4	4	1	6	6	5	2	2
Switch Phase											
Minimum Initial (s)	5.0	10.0	5.0	7.0	7.0	5.0	10.0	10.0	5.0	10.0	10.0
Minimum Split (s)	10.0	36.6	10.0	34.6	34.6	11.4	27.1	27.1	11.4	22.1	22.1
Total Split (s)	18.0	41.4	22.0	45.4	45.4	12.2	44.0	44.0	12.6	44.4	44.4
Total Split (%)	15.0%	34.5%	18.3%	37.8%	37.8%	10.2%	36.7%	36.7%	10.5%	37.0%	37.0%
Yellow Time (s)	3.0	3.3	3.0	3.3	3.3	4.4	5.1	5.1	4.4	5.1	5.1
All-Red Time (s)	2.0	2.3	2.0	2.3	2.3	2.0	1.0	1.0	2.0	1.0	1.0
Lost Time Adjust (s)	0.0	0.0	0.0	0.0	0.0	0.0	0.0	0.0	0.0	0.0	0.0
Total Lost Time (s)	5.0	5.6	5.0	5.6	5.6	6.4	6.1	6.1	6.4	6.1	6.1
Lead/Lag	Lead	Lag	Lead	Lag	Lag	Lead	Lag	Lag	Lead	Lag	Lag
Lead-Lag Optimize?	Yes	Yes	Yes	Yes	Yes	Yes	Yes	Yes	Yes	Yes	Yes
Recall Mode	None	None	None	None	None	None	C-Max	C-Max	None	C-Max	C-Max
Act Effct Green (s)	14.0	10.0	29.2	24.1	24.1	72.4	66.6	66.6	74.9	69.5	69.5
Actuated g/C Ratio	0.12	0.08	0.24	0.20	0.20	0.60	0.56	0.56	0.62	0.58	0.58
v/c Ratio	0.08	0.34	0.82	0.04	0.16	0.17	0.52	0.22	0.28	0.42	0.01
Control Delay	34.3	23.7	59.9	40.0	0.8	9.6	19.0	6.8	10.8	16.5	0.0
Queue Delay	0.0	0.0	0.0	0.0	0.0	0.0	0.0	0.0	0.0	0.0	0.0
Total Delay	34.3	23.7	59.9	40.0	0.8	9.6	19.0	6.8	10.8	16.5	0.0
LOS	C	C	E	D	A	A	B	A	B	B	A
Approach Delay		25.7		48.1			16.6			15.8	
Approach LOS		C		D			B			B	

Intersection Summary

Cycle Length: 120
 Actuated Cycle Length: 120
 Offset: 0 (0%), Referenced to phase 2:SBTL and 6:NBTL, Start of Green
 Natural Cycle: 90
 Control Type: Actuated-Coordinated
 Maximum v/c Ratio: 0.82
 Intersection Signal Delay: 20.8
 Intersection LOS: C
 Intersection Capacity Utilization 66.2%
 ICU Level of Service C
 Analysis Period (min) 15

Splits and Phases: 1: Scottsdale Rd. & Ashler Hills Dr.

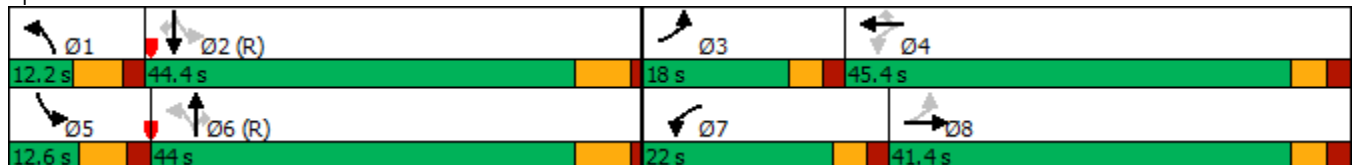

21-0480 Ashler Hills
2022 Total SAT

1: Scottsdale Rd. & Ashler Hills Dr.
HCM 6th Signalized Intersection Summary

Movement	EBL	EBT	EBR	WBL	WBT	WBR	NBL	NBT	NBR	SBL	SBT	SBR
Lane Configurations												
Traffic Volume (veh/h)	13	10	46	254	15	61	57	938	190	80	787	12
Future Volume (veh/h)	13	10	46	254	15	61	57	938	190	80	787	12
Initial Q (Qb), veh	0	0	0	0	0	0	0	0	0	0	0	0
Ped-Bike Adj(A_pbT)	1.00		1.00	1.00		1.00	1.00		1.00	1.00		1.00
Parking Bus, Adj	1.00	1.00	1.00	1.00	1.00	1.00	1.00	1.00	1.00	1.00	1.00	1.00
Work Zone On Approach		No			No			No			No	
Adj Sat Flow, veh/h/ln	1870	1870	1870	1870	1870	1870	1870	1870	1870	1870	1870	1870
Adj Flow Rate, veh/h	14	11	38	276	16	32	62	1020	104	87	855	6
Peak Hour Factor	0.92	0.92	0.92	0.92	0.92	0.92	0.92	0.92	0.92	0.92	0.92	0.92
Percent Heavy Veh, %	2	2	2	2	2	2	2	2	2	2	2	2
Cap, veh/h	198	30	103	384	388	329	385	1937	864	312	1948	869
Arrive On Green	0.02	0.08	0.08	0.14	0.21	0.21	0.04	0.55	0.55	0.04	0.55	0.55
Sat Flow, veh/h	1781	368	1273	1781	1870	1585	1781	3554	1585	1781	3554	1585
Grp Volume(v), veh/h	14	0	49	276	16	32	62	1020	104	87	855	6
Grp Sat Flow(s),veh/h/ln	1781	0	1641	1781	1870	1585	1781	1777	1585	1781	1777	1585
Q Serve(g_s), s	0.9	0.0	3.4	16.7	0.8	2.0	1.8	22.0	3.8	2.6	17.2	0.2
Cycle Q Clear(g_c), s	0.9	0.0	3.4	16.7	0.8	2.0	1.8	22.0	3.8	2.6	17.2	0.2
Prop In Lane	1.00		0.78	1.00		1.00	1.00		1.00	1.00		1.00
Lane Grp Cap(c), veh/h	198	0	133	384	388	329	385	1937	864	312	1948	869
V/C Ratio(X)	0.07	0.00	0.37	0.72	0.04	0.10	0.16	0.53	0.12	0.28	0.44	0.01
Avail Cap(c_a), veh/h	363	0	490	384	620	526	406	1937	864	333	1948	869
HCM Platoon Ratio	1.00	1.00	1.00	1.00	1.00	1.00	1.00	1.00	1.00	1.00	1.00	1.00
Upstream Filter(I)	1.00	0.00	1.00	1.00	1.00	1.00	1.00	1.00	1.00	1.00	1.00	1.00
Uniform Delay (d), s/veh	49.3	0.0	52.2	41.2	38.0	38.5	12.2	17.4	13.3	13.3	16.1	12.3
Incr Delay (d2), s/veh	0.1	0.0	0.6	5.5	0.0	0.0	0.1	1.0	0.3	0.2	0.7	0.0
Initial Q Delay(d3),s/veh	0.0	0.0	0.0	0.0	0.0	0.0	0.0	0.0	0.0	0.0	0.0	0.0
%ile BackOfQ(50%),veh/ln	0.4	0.0	1.4	7.9	0.4	0.8	0.7	9.0	1.4	1.0	7.1	0.1
Unsig. Movement Delay, s/veh												
LnGrp Delay(d),s/veh	49.4	0.0	52.8	46.7	38.0	38.5	12.3	18.4	13.6	13.5	16.9	12.3
LnGrp LOS	D	A	D	D	D	D	B	B	B	B	B	B
Approach Vol, veh/h		63			324			1186			948	
Approach Delay, s/veh		52.1			45.5			17.7			16.5	
Approach LOS		D			D			B			B	
Timer - Assigned Phs	1	2	3	4	5	6	7	8				
Phs Duration (G+Y+Rc), s	10.8	71.9	6.9	30.5	11.1	71.5	22.0	15.4				
Change Period (Y+Rc), s	6.4	6.1	5.0	5.6	6.4	6.1	5.0	5.6				
Max Green Setting (Gmax), s	5.8	38.3	13.0	39.8	6.2	37.9	17.0	35.8				
Max Q Clear Time (g_c+I1), s	3.8	19.2	2.9	4.0	4.6	24.0	18.7	5.4				
Green Ext Time (p_c), s	0.0	4.1	0.0	0.1	0.0	4.6	0.0	0.1				
Intersection Summary												
HCM 6th Ctrl Delay			21.7									
HCM 6th LOS			C									
Notes												
User approved pedestrian interval to be less than phase max green.												

Intersection						
Int Delay, s/veh	3.1					
Movement	EBL	EBT	WBT	WBR	SBL	SBR
Lane Configurations						
Traffic Vol, veh/h	37	23	41	1	0	9
Future Vol, veh/h	37	23	41	1	0	9
Conflicting Peds, #/hr	0	0	0	0	0	0
Sign Control	Free	Free	Free	Free	Stop	Stop
RT Channelized	-	None	-	None	-	None
Storage Length	75	-	-	-	0	-
Veh in Median Storage, #	-	0	0	-	0	-
Grade, %	-	0	0	-	0	-
Peak Hour Factor	92	92	92	92	92	92
Heavy Vehicles, %	2	2	2	2	2	2
Mvmt Flow	40	25	45	1	0	10

Major/Minor	Major1	Major2	Minor2		
Conflicting Flow All	46	0	-	0	151
Stage 1	-	-	-	-	46
Stage 2	-	-	-	-	105
Critical Hdwy	4.12	-	-	-	6.42
Critical Hdwy Stg 1	-	-	-	-	5.42
Critical Hdwy Stg 2	-	-	-	-	5.42
Follow-up Hdwy	2.218	-	-	-	3.518
Pot Cap-1 Maneuver	1562	-	-	-	841
Stage 1	-	-	-	-	976
Stage 2	-	-	-	-	919
Platoon blocked, %		-	-	-	
Mov Cap-1 Maneuver	1562	-	-	-	819
Mov Cap-2 Maneuver	-	-	-	-	819
Stage 1	-	-	-	-	951
Stage 2	-	-	-	-	919

Approach	EB	WB	SB
HCM Control Delay, s	4.5	0	8.6
HCM LOS			A

Minor Lane/Major Mvmt	EBL	EBT	WBT	WBR	SBLn1
Capacity (veh/h)	1562	-	-	-	1023
HCM Lane V/C Ratio	0.026	-	-	-	0.01
HCM Control Delay (s)	7.4	-	-	-	8.6
HCM Lane LOS	A	-	-	-	A
HCM 95th %tile Q(veh)	0.1	-	-	-	0

Intersection						
Int Delay, s/veh	2.5					
Movement	EBL	EBT	WBT	WBR	SBL	SBR
Lane Configurations						
Traffic Vol, veh/h	24	56	46	0	0	22
Future Vol, veh/h	24	56	46	0	0	22
Conflicting Peds, #/hr	0	0	0	0	0	0
Sign Control	Free	Free	Free	Free	Stop	Stop
RT Channelized	-	None	-	None	-	None
Storage Length	75	-	-	-	0	-
Veh in Median Storage, #	-	0	0	-	0	-
Grade, %	-	0	0	-	0	-
Peak Hour Factor	92	92	92	92	92	92
Heavy Vehicles, %	2	2	2	2	2	2
Mvmt Flow	26	61	50	0	0	24

Major/Minor	Major1	Major2	Minor2		
Conflicting Flow All	50	0	-	0	163 50
Stage 1	-	-	-	-	50 -
Stage 2	-	-	-	-	113 -
Critical Hdwy	4.12	-	-	-	6.42 6.22
Critical Hdwy Stg 1	-	-	-	-	5.42 -
Critical Hdwy Stg 2	-	-	-	-	5.42 -
Follow-up Hdwy	2.218	-	-	-	3.518 3.318
Pot Cap-1 Maneuver	1557	-	-	-	828 1018
Stage 1	-	-	-	-	972 -
Stage 2	-	-	-	-	912 -
Platoon blocked, %		-	-	-	
Mov Cap-1 Maneuver	1557	-	-	-	814 1018
Mov Cap-2 Maneuver	-	-	-	-	814 -
Stage 1	-	-	-	-	955 -
Stage 2	-	-	-	-	912 -

Approach	EB	WB	SB
HCM Control Delay, s	2.2	0	8.6
HCM LOS			A

Minor Lane/Major Mvmt	EBL	EBT	WBT	WBR	SBLn1
Capacity (veh/h)	1557	-	-	-	1018
HCM Lane V/C Ratio	0.017	-	-	-	0.023
HCM Control Delay (s)	7.4	-	-	-	8.6
HCM Lane LOS	A	-	-	-	A
HCM 95th %tile Q(veh)	0.1	-	-	-	0.1

Intersection						
Int Delay, s/veh	2.8					
Movement	EBL	EBT	WBT	WBR	SBL	SBR
Lane Configurations						
Traffic Vol, veh/h	48	63	50	1	0	18
Future Vol, veh/h	48	63	50	1	0	18
Conflicting Peds, #/hr	0	0	0	0	0	0
Sign Control	Free	Free	Free	Free	Stop	Stop
RT Channelized	-	None	-	None	-	None
Storage Length	75	-	-	-	0	-
Veh in Median Storage, #	-	0	0	-	0	-
Grade, %	-	0	0	-	0	-
Peak Hour Factor	92	92	92	92	92	92
Heavy Vehicles, %	2	2	2	2	2	2
Mvmt Flow	52	68	54	1	0	20

Major/Minor	Major1	Major2	Minor2		
Conflicting Flow All	55	0	-	0	227 55
Stage 1	-	-	-	-	55 -
Stage 2	-	-	-	-	172 -
Critical Hdwy	4.12	-	-	-	6.42 6.22
Critical Hdwy Stg 1	-	-	-	-	5.42 -
Critical Hdwy Stg 2	-	-	-	-	5.42 -
Follow-up Hdwy	2.218	-	-	-	3.518 3.318
Pot Cap-1 Maneuver	1550	-	-	-	761 1012
Stage 1	-	-	-	-	968 -
Stage 2	-	-	-	-	858 -
Platoon blocked, %		-	-	-	
Mov Cap-1 Maneuver	1550	-	-	-	735 1012
Mov Cap-2 Maneuver	-	-	-	-	735 -
Stage 1	-	-	-	-	935 -
Stage 2	-	-	-	-	858 -

Approach	EB	WB	SB
HCM Control Delay, s	3.2	0	8.6
HCM LOS			A

Minor Lane/Major Mvmt	EBL	EBT	WBT	WBR	SBLn1
Capacity (veh/h)	1550	-	-	-	1012
HCM Lane V/C Ratio	0.034	-	-	-	0.019
HCM Control Delay (s)	7.4	-	-	-	8.6
HCM Lane LOS	A	-	-	-	A
HCM 95th %tile Q(veh)	0.1	-	-	-	0.1

21-0480: Ashler Hills

Sight Distance Analysis

Location: Access & Ashler Hills

Assumptions and/or Given

Elements of Design from AASHTO	6th Edition	AASHTO Ref
Driver Eye Height		
Passenger Vehicle	3.50 ft	§3.2.6.1, p 3-15
Truck	7.60 ft	§3.2.6.1, p 3-15
Object Height		
Stopping Sight Distance	2.00 ft	§3.2.6.2, p 3-15
Passing Sight Distance	3.50 ft	§3.2.6.2, p 3-15
Vehicle Height	4.25 ft	§3.2.6.1, p 3-15
Driver Eye Location		
From Edge of Major Rd Traveled Way	14.50 ft	§9.5.3.2.1, p 9-43
Deceleration Rate (a)		
Passenger Vehicle	11.20 ft/sec ²	§3.2.2.2, p 3-4
Truck	N/A ft	
Brake reaction time (t)	2.50 sec	§3.2.2.1, p 3-3

Site Specific Data (Bike & turn lanes are outside traveled way and are not considered)

Major Street Design Speed (V _{major})	30	MPH
Grades - Approaching Minor Street from: (- = approaching downhill)		
Left (G _L)		%
Right (G _R)		%
Approach Grade Adjustment Factor	Left 1.0	Right 1.0
		Tbl 9-5, p 9-42
Major Road Through Lanes on Each Approach	1.0	(Use 1 for RI/RO/[LI] only)
Median Width (in "Lane Equivalents")		(Use 0 for RI/RO/[LI] only)
Minor Road Approach Upgrade, if >3%		%
Minor Road Access (check restricted)	LI	LO/Th RO

Stopping Sight Distance = Brake Reaction Distance + Braking Distance

Neglecting Effect of Grade $d = 1.47Vt + 1.075 \frac{V^2}{a}$ Eq 3-2, p 3-5

Calculated d= 196.7 ft
Design d= 200 ft

With Effect of Grade $d = 1.47Vt + \frac{V^2}{30((\frac{a}{32.2}) \pm G)}$ Eq 3-3, p 3-5

Calculated d= 196.3 ft - left
200 ft - right
Design d= 196.3 ft - left
200 ft - right

SSD's do not consider design for truck operations, since better visibility is considered to offset longer braking distance. §3.2.2.5, p 3-6



21-0480: Ashler Hills

Sight Distance Analysis

Location: Access & Ashler Hills

Intersection Sight Distances

Case B—Intersections with Stop Control on the Minor Road

AASHTO Ref
§9.5.3.2, p 9-42

Case B1—Left Turn from the Minor Road

§9.5.3.2.1, p 9-43

Design Vehicle	Time Gap (t _g)	AASHTO Ref
Passenger Car	7.5 sec	Tbl 9-6, p 9-44
Single-Unit Tuck	9.5 sec	Tbl 9-6, p 9-44
Combination Truck	11.5 sec	Tbl 9-6, p 9-44

Time gap adjustments

Add'l lanes to cross (1 st is assumed)		
Passenger Car	0.5 sec	See Notes
Trucks	0.7 sec	below
Minor Approach Upgrade (Per each 1%>3%)	0.2 sec	Tbl 9-5, p 9-37

Site data

Major Road Lanes on Left Approach	1.0	§9.5.3.2.1, p 9-44
Minor Road Approach Upgrade, if >3%	0 %	§9.5.3.2.1, p 9-44

Time Gap based on site data

Design Vehicle Gap+Adj for Approach Grade>3%+Adjs for Add'l Lanes & Median

Passenger Car	7.5 sec
Single-Unit Tuck	9.5 sec
Combination Truck	11.5 sec

ISD to left & right along Major Road ISD=1.47V_{major}t_g (ft) Eq 9-1, p 9-45

Vehicle	calculated ISD=	design ISD=	ISD to Left and Right
Passenger Car	330.8 ft	335 ft	
Single-Unit Tuck	419.0 ft	420 ft	
Combination Truck	507.2 ft	510 ft	



21-0480: Ashler Hills

Sight Distance Analysis

Location: Access & Ashler Hills

Intersection Sight Distances (cont'd)

		<i>AASHTO Ref</i>
<u>Case B2—Right Turn from the Minor Road</u>		§9.5.3.2.2, p 9-47
&		
<u>Case B3—Crossing Maneuver from the Minor Road</u>		§9.5.3.2.3, p 9-48
Design Vehicle	Time Gap (t _g)	
Passenger Car	6.5 sec	Tbl 9-8, p 9-47
Single-Unit Tuck	8.5 sec	&
Combination Truck	10.5 sec	Tbl 9-10, p 9-49
Time gap adjustments		
Add'l lanes to cross (1 st is assumed) - Case B-3 Only*		
Passenger Car	0.5 sec	See Notes
Trucks	0.7 sec	below
Minor Approach Upgrade (Per each 1%>3%)		
Case B-2 Only	0.1 sec	Tbl 9-8, p 9-47
Case B-3 Only	0.2 sec	Tbl 9-10, p 9-49
Site data		
Major Road Lanes on Left Approach	1.0	§9.5.3.2.2, p 9-47
Minor Road Approach Upgrade, if >3%	0 %	§9.5.3.2.2, p 9-47
Time Gap based on site data (sec)		
	<u>B2 & B3</u>	<u>B3 Only</u>
<i>Design Vehicle Gap+Adj for Approach Grade>3%(+Adjs for Add'l Lanes & Median for B3)</i>		
Passenger Car	6.5	6.5
Single-Unit Tuck	8.5	8.5
Combination Truck	10.5	10.5
ISD to left (B2/B3) & right (B3) along Major Rd ISD=1.47V _{major} t _g (ft) Eq 9-1, p 9-45		
		ISD to Left ISD to right
		<u>(B2 & B3)</u> <u>(B3 Only)</u>
Passenger Car	calculated ISD= 286.7	286.7
	design ISD= 290	290
Single-Unit Tuck	calculated ISD= 374.9	374.9
	design ISD= 375	375
Combination Truck	calculated ISD= 463.1	463.1
	design ISD= 465	465

*Number of major road lanes is irrelevant in Case B2.

The differences between Case B1 and Cases B2 & B3 are reduced time gaps and time gap adjustment for the minor approach upgrade. §9.5.3.2.3, p 9-48



21-0480: Ashler Hills

Sight Distance Analysis

Location: Access & Ashler Hills

Intersection Sight Distances (cont'd)

		<i>AASHTO Ref</i>
Case F—Left Turns from the Major Road		§9.5.3.6, p 9-56
Design Vehicle	Time Gap (t _g)	
Passenger Car	5.5 sec	Tbl 9-16, p 9-57
Single-Unit Tuck	6.5 sec	Tbl 9-16, p 9-57
Combination Truck	7.5 sec	Tbl 9-16, p 9-57
Time gap adjustments		
Add'l lanes to cross (1 assumed)		
Passenger Car	0.5 sec	See Notes to
Trucks	0.7 sec	Tbl 9-16, p 9-57
Site data		
Opposing Lanes (adj'd for x-wide median)	0.0	
Time Gap based on site data		
<i>Design Vehicle Gap+Adj for Add'l Opposing Lanes</i>		
Passenger Car	5.5 sec	
Single-Unit Tuck	6.5 sec	
Combination Truck	7.5 sec	
ISD to front along Major Road	ISD=1.47V _{major} t _g (ft)	Eq 9-1, p 9-45
Passenger Car	calculated ISD= 242.6 ft	
	design ISD= 245 ft	
Single-Unit Tuck	calculated ISD= 286.7 ft	
	design ISD= 290 ft	
Combination Truck	calculated ISD= 330.8 ft	
	design ISD= 335 ft	

The differences between Case F and Cases B1, B2 & B3 are reduced time gaps and no time gap adjustment for any minor approach upgrade. §9.5.3.6, p 9-58

SIGHT DISTANCE SUMMARY

Sight Distance Type	Governing Case	Car	SU Truck	Combo Truck
Stopping				
Without effect of grade		200	N/A	N/A
With effect of grade on left		200	N/A	N/A
With effect of grade on right		200	N/A	N/A
Intersection				
To Right	B1	335	420	510
To Left	B2/B3	290	375	465
On Major Road	F	245	290	335



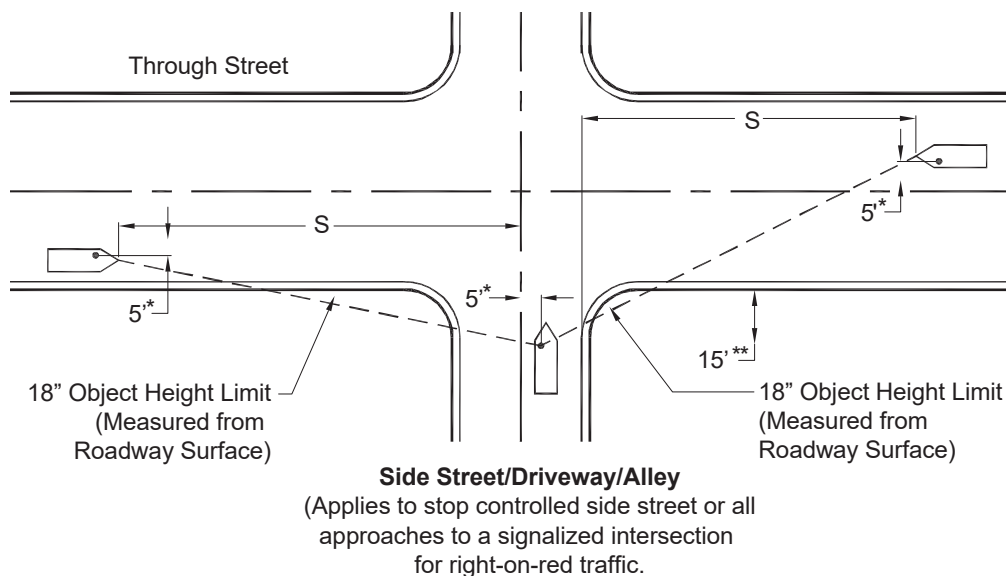

* 5 feet measured to nearest lane line or centerline.

**15 feet measured from face-of-curb or edge-of-travelway.

S = Intersection sight distance in feet on drivers left and right for right turns, left turns and through traffic.
(See *2004 AASHTO Geometric Design of Highways and Streets* for additional sight distance requirements.)

(See [Appendix 5-3A](#), [Appendix 5-3B](#) and [Appendix 5-3C](#) for distance S.)

FIGURE 5.3-26 INTERSECTION & DRIVEWAY DEPARTURE SIGHT DISTANCE REQUIREMENTS

1. Right-Angle Intersections

Right-angle intersections are those whose legs meet at an angle of 88 to 90 degrees. For these right-angle intersections the sight distances shown in [Appendix 5-3A](#), [Appendix 5-3B](#) and [Appendix 5-3C](#) are to be used with [Figure 5.3-26](#) to calculate the sight triangle. Appendices 5-3A and 5-3B present the intersection sight distances for all street classifications which were determined assuming passenger car traffic. [Appendix 5-3C](#) presents the sight distance requirements for varying roadway widths and design speeds for passenger cars, single unit trucks and combination trucks. If high volumes of truck traffic are anticipated, sight distances given in [Appendix 5-3C](#) will be used. Sight distances for vehicles turning left from the main street should also be considered and calculated based on the *AASHTO Geometric Design of Highways and Streets*.

2. Skewed Intersections

For skewed intersections where the intersection angles are less than 88 degrees, sight distances must be calculated in accordance with the procedures described in *AASHTO's Geometric Design of Highways and Streets*. Skewed intersection design must include appropriate design for pedestrian crossings and the location of curb ramps.

3. Intersections Within or Near a Curve

Sight distance measurements, identified as S in [Figure 5.3-26](#), need to follow the curved street alignment when the intersection is within or near a horizontal curve.

4. Traffic Safety Triangles

Traffic Safety Triangles should be used as a means to limit the height of structures, vegetation and other improvements on corner properties immediately adjacent to intersections. **Safety triangles are not to be used as a substitute for intersection sight distance!** Safety triangles provide additional visibility around corners for all intersection approaches and should be applied to the design of perimeter walls and

landscape features. Items within the safety triangle cannot be higher than 18" measured from the roadway surface. [Figure 5.3-27](#) depicts the method used to determine the safety triangle location. The sight distance requirements contained in both [Figure 5.3-26](#) and [Figure 5.3-27](#) are applied at all corner lots.

5. Right-of-Way at Corners

A minimum of 25-foot radius rights-of-way shall be dedicated at street intersections to provide room for traffic control and sight distance.

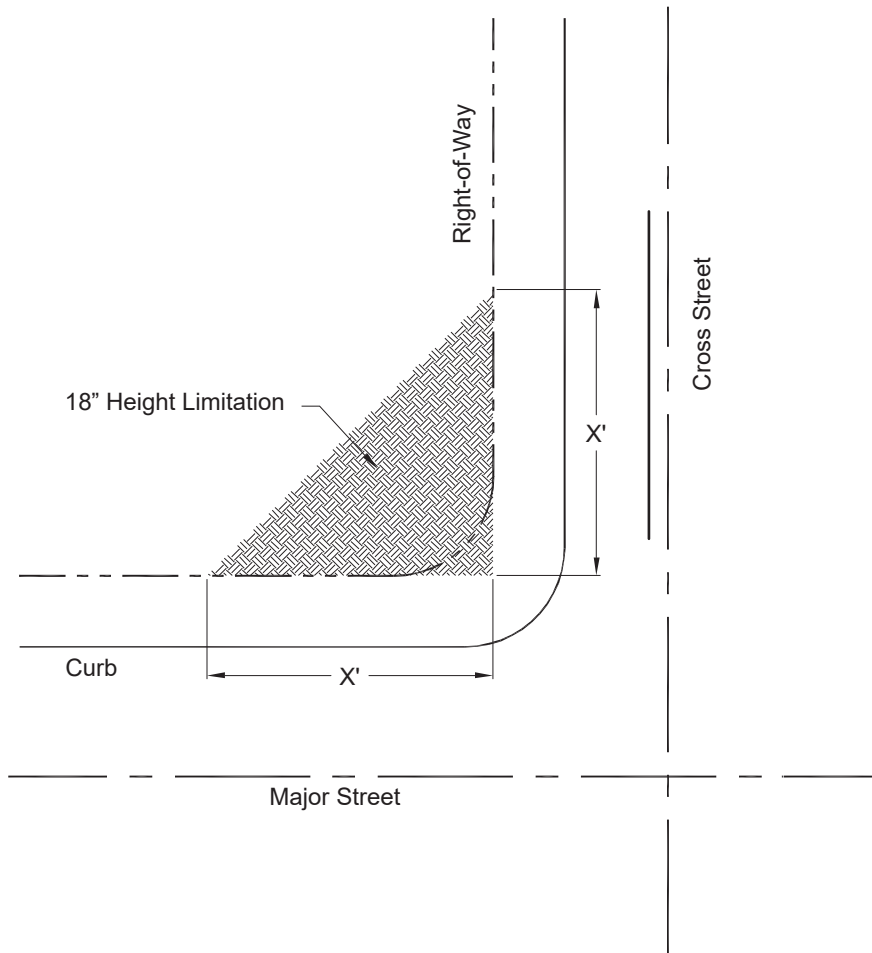

Major Street Classification	X (in feet)
Parkway, Expressway, Arterials, Major Collector	25
Minor Collector	35
* Local Streets	35 / 60 / 70

* If the standard right-of-way (46 ft. local residential, 60 ft. local collector) is not available, the safety triangle (X) shall measure 60 ft. on local residential streets and 70 ft. on local collector streets from the centerlines of the streets.

FIGURE 5.3-27 TRAFFIC SAFETY TRIANGLE ON CORNER PROPERTY

E. Auxiliary Lanes

An exclusive turning lane permits separation of conflicting traffic movements and removes turning vehicles from the flow of through traffic. [Figure 5.3-28](#) and [Figure 5.3-29](#) depict the



INTERSECTION & DRIVEWAY SIGHT DISTANCE REQUIREMENTS

Six Lane Roadway

Design Speed	Sight Distance (S)					
	Passenger Car (ft)		Single Unit Truck (ft)		Combination Truck (ft)	
	TH	LT	TH	LT	TH	LT
25	350	350	470	455	540	530
30	420	420	560	545	650	635
35	490	490	655	635	760	740
40	560	560	780	725	865	845
45	630	630	840	815	975	950
50	700	700	935	905	1080	1055
55	770	770	1030	995	1190	1160

Three Lane Roadway

Design Speed	Sight Distance (S)					
	Passenger Car (ft)		Single Unit Truck (ft)		Combination Truck (ft)	
	TH	LT	TH	LT	TH	LT
25	260	295	340	375	415	450
30	310	355	410	450	495	540
35	360	415	475	525	580	630
40	415	470	545	600	660	720
45	465	530	610	675	745	810
50	515	590	680	750	825	900
55	570	650	745	825	910	990

Four Lane Roadway

Design Speed	Sight Distance (S)					
	Passenger Car (ft)		Single Unit Truck (ft)		Combination Truck (ft)	
	TH	LT	TH	LT	TH	LT
25	315	335	415	430	490	500
30	375	400	500	515	590	600
35	440	465	585	600	685	700
40	500	530	665	685	785	800
45	565	565	750	770	880	900
50	625	665	835	855	980	1000
55	690	730	915	940	1075	1100

Two Lane Roadway

Design Speed	Sight Distance (S)					
	Passenger Car (ft)		Single Unit Truck (ft)		Combination Truck (ft)	
	TH	LT	TH	LT	TH	LT
25	240	280	315	350	390	425
30	290	335	375	420	465	510
35	335	390	440	490	540	595
40	385	445	500	560	620	880
45	430	500	565	630	695	765
50	480	555	625	700	775	845
55	530	610	690	770	850	930

Notes:

- TH=Through Movement, LT = Turn Movement
- Design speed by roadway classification is shown in [Appendix 5-3A](#) and [Appendix 5-3B](#). Typically design speed is equal to the speed limit +10 mph.
- Refer to the 2004 AASHTO Geometric Design of Highways and Streets for additional information.

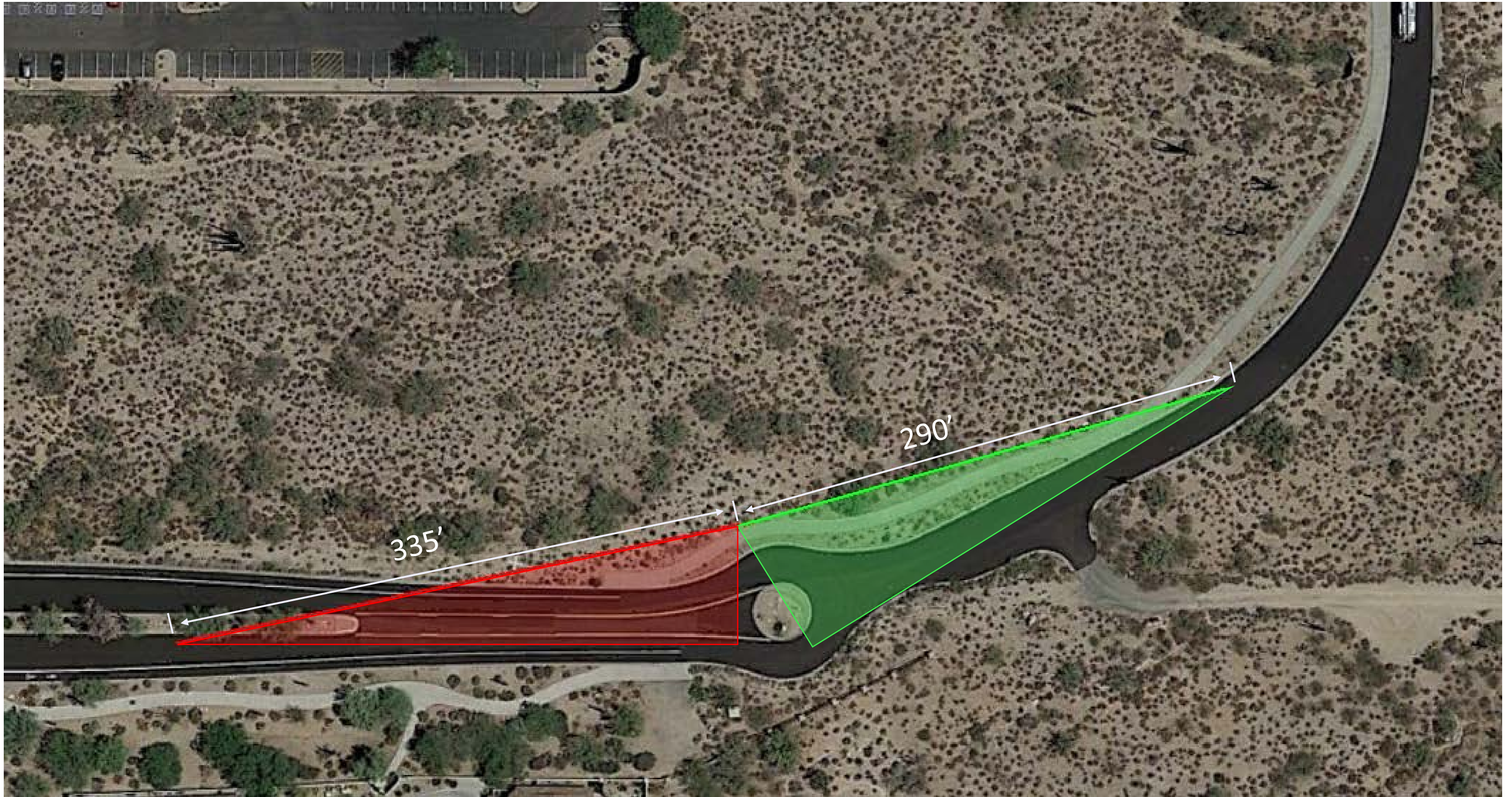

****Note:** Sight distance was measured based on a 15' setback from edge of curb with and offset of 5' to the right from the center of the driveway.

