



Water Study

PRELIMINARY WATER AND WASTEWATER BASIS OF DESIGN REPORT

FOR

CORE CENTER

SCOTTSDALE, ARIZONA

Prepared for:

CAPITAL COMMERCIAL HOLDINGS, LLC

9943 E. Bell Road
Scottsdale, AZ 85260

Prepared by:



6859 E Rembrandt Ave, #124
Mesa, AZ 85212
480-223-8573



A handwritten signature in black ink, appearing to read "Wade E. Cooke", written over the bottom portion of the professional seal.

PRELIMINARY Basis of Design Report

- ACCEPTED**
- ACCEPTED AS NOTED**
- REVISE AND RESUBMIT**



Disclaimer: If accepted; the preliminary approval is granted under the condition that a final basis of design report will also be submitted for city review and approval (typically during the DR or PP case). The final report shall incorporate further water or sewer design and analysis requirements as defined in the city design standards and policy manual and address those items noted in the preliminary review comments (both separate and included herein). The final report shall be submitted and approved prior to the plan review submission.

For questions or clarifications contact the Water Resources Planning and Engineering Department at 480-312-5685.

BY rsacks

DATE 9/23/2019

June 3, 2019
Revised July 30, 2019
Revised Sept. 19, 2019
Job # 1615

**PRELIMINARY WATER & WASTEWATER
BASIS OF DESIGN REPORT
FOR
CORE CENTER**

TABLE OF CONTENTS

1.0	PROJECT DESCRIPTION	1
2.0	EXISTING CONDITIONS	1
3.0	BASIS OF DESIGN	1
4.0	CONCLUSIONS	2

FIGURE 1 Location Map

FIGURE 2 Preliminary Site Utility Plan

FIGURE 3 Water/Sewer Quarter Section Map

APPENDIX A Figures

APPENDIX B Water & Sewer Calculations

APPENDIX C Hydrant Flow Test Report & Fire Flow Information

APPENDIX D Excerpts from *Water Distribution System Report for Impact
Church/Sunrise Commons*

APPENDIX E Excerpts from *Wastewater Collection System Report for Impact
Church/Sunrise Commons*

1.0 PROJECT DESCRIPTION

Core Center is a high-end mixed use development comprising restaurant, retail, and office uses. The site was formerly a commercially-zoned car dealership (Sun Pontiac) but is currently vacant. In 2014 the Scottsdale City Council approved a General Plan amendment and rezoning to allow non-commercial redevelopment of the property consisting of apartments and a church. The CORE apartments were subsequently built but Impact Church decided not to pursue its relocation and now proposes to re-establish commercial use on its property.

The site is located southeast of Hayden Road and to the southwest of Northsight Boulevard in Section 1, Township 3 North, Range 4 East. The site is bounded by Hayden Road to the northwest, commercial development to the east, Core Apartments to the south and southeast, and Costco to the west. The site has been rough-graded and has minimal vegetation. It slopes generally from northeast to southwest.

2.0 EXISTING CONDITIONS

Water Distribution System

There are existing City of Scottsdale 12-inch ACP public water mains located in Hayden Road and in 84th Street. There is also an existing 8" DIP public water loop which passes through the site, entering at the 84th Street alignment and leaving near the northeast corner. The loop was modified as part of the construction of the CORE Apartments development (see Appendix D). See the *Preliminary Site Utility Plan* (Appendix A) for locations of existing water lines.

Sanitary Sewer System

There are two City of Scottsdale 8" public sewer mains running parallel in Hayden Road which flow to the west. The south main is constructed of PVC and enters the property at the northeast corner of the subject property extending approximately 400 feet to the south in a public sewer easement. This parallel sewer main was constructed because of sewer capacity issues with the north main and serves the existing CORE Apartment development (see Appendix E).

The north main in Hayden Road is constructed of VCP and extends both east and west of the subject parcel. At the 84th Street alignment there is a lateral which extends into the site, terminating near the southwestern portion of the lot. This 8" sewer served the old car dealership. There is also an existing 8" stub at the property line near the easternmost driveway. See the *Preliminary Site Utility Plan* (Appendix A) for locations of existing sanitary sewer facilities.

3.0 BASIS OF DESIGN

Water Distribution System

The existing 8-inch onsite water loop will be utilized for the proposed development. A portion of this loop will be relocated to avoid conflict with Building D and E (see Appendix A). The proposed water line relocation and appurtenances will be

contained within a water line easement in accordance with City of Scottsdale requirements. The buildings will have separate domestic water and fire services. The existing site has sufficient fire hydrants, therefore no new hydrants are proposed. See the *Preliminary Site Utility Plan* (Appendix A) for location and sizes of proposed water lines serving the Project.

Domestic Water

For the purposes of this Rezoning review, the total daily water demand for this project was calculated to be 606,424 GPD based on *The City of Scottsdale DS&PM*, Figure 6-1.2 (Appendix B). Detailed calculations based on fixture type/count will be provided during the final design phase of this project.

Fire

Fire flow requirements for the project are as follows:

Building Area =	192,635 SF
Construction Type =	III-B
Fire Flow Required =	8,000 gpm (from IFC Table B105.1)
Min. Fire Flow Required =	2,000 gpm (75% reduction for fire sprinklers)

A fire hydrant flow test was conducted in accordance with DS&PM Chapter 6 and is included in Appendix C. Based on the certified hydrant flow test, the flow rate at a residual pressure of 30 psi is 3,086 gpm. This residual flow rate is greater the required fire flow and therefore meets the requirements for the proposed building in accordance with City of Scottsdale’s DS&PM and International Fire Code (IFC) requirements. If required, a water distribution model and detailed analysis will be provided with final design.

Sewer

A new 8-inch sewer service will be installed for this development discharging to the south sewer main in Hayden Road as shown in the *Preliminary Site Utility Plan* (Appendix A). The existing sewer onsite sewer will be abandoned due to downstream sewer capacity issues. Wastewater from each building will be collected in the 8-inch private sewer line in accordance with City of Scottsdale minimum requirements for commercial developments and discharged into the 8” sewer in Hayden Road. Additional offsite improvements will be necessary to accommodate flows from this development.

4.0 CONCLUSIONS

- Water and sewer infrastructure will be designed in accordance with the City of Scottsdale’s Design Standards and Policies Manual (DS&PM), M.A.G. and City of Scottsdale supplemental details and specifications.
- A portion of the existing onsite 8” public water loop will be relocated to avoid conflicts with one of the proposed buildings.

- The domestic water services and meters will be adequately sized to meet the water demand for the proposed buildings.
- The existing and proposed water distribution system has adequate capacity to meet Project fire flow demand in accordance with the DS&PM and IFC requirements.
- The existing sewer serving the old car dealership will be partially re-routed and utilized for the proposed development.
- The proposed 8-inch sewer line is adequately sized to meet the calculated wastewater demand.
- All construction will be in compliance with applicable environmental laws and regulations.

APPENDIX A
FIGURES

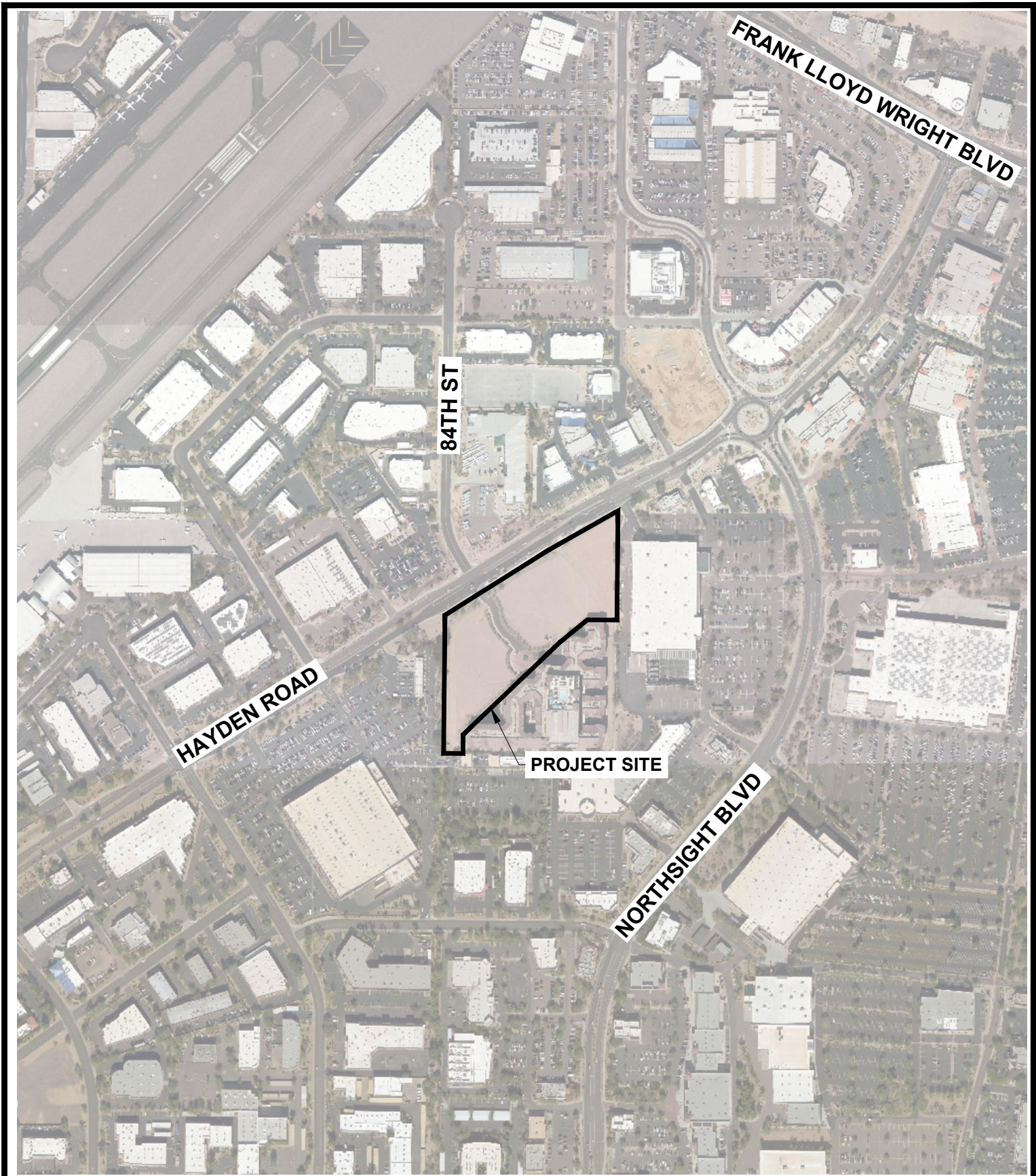

6859 E. Rembrandt Ave, 124
Phoenix, AZ 85212
Ph: (480) 223-8573
landcorconsulting.com

DATE: 5/30/19

SCALE: 1"=500'

FIGURE 1
LOCATION MAP

JOB NO.
1615

PRELIMINARY SITE UTILITY PLAN

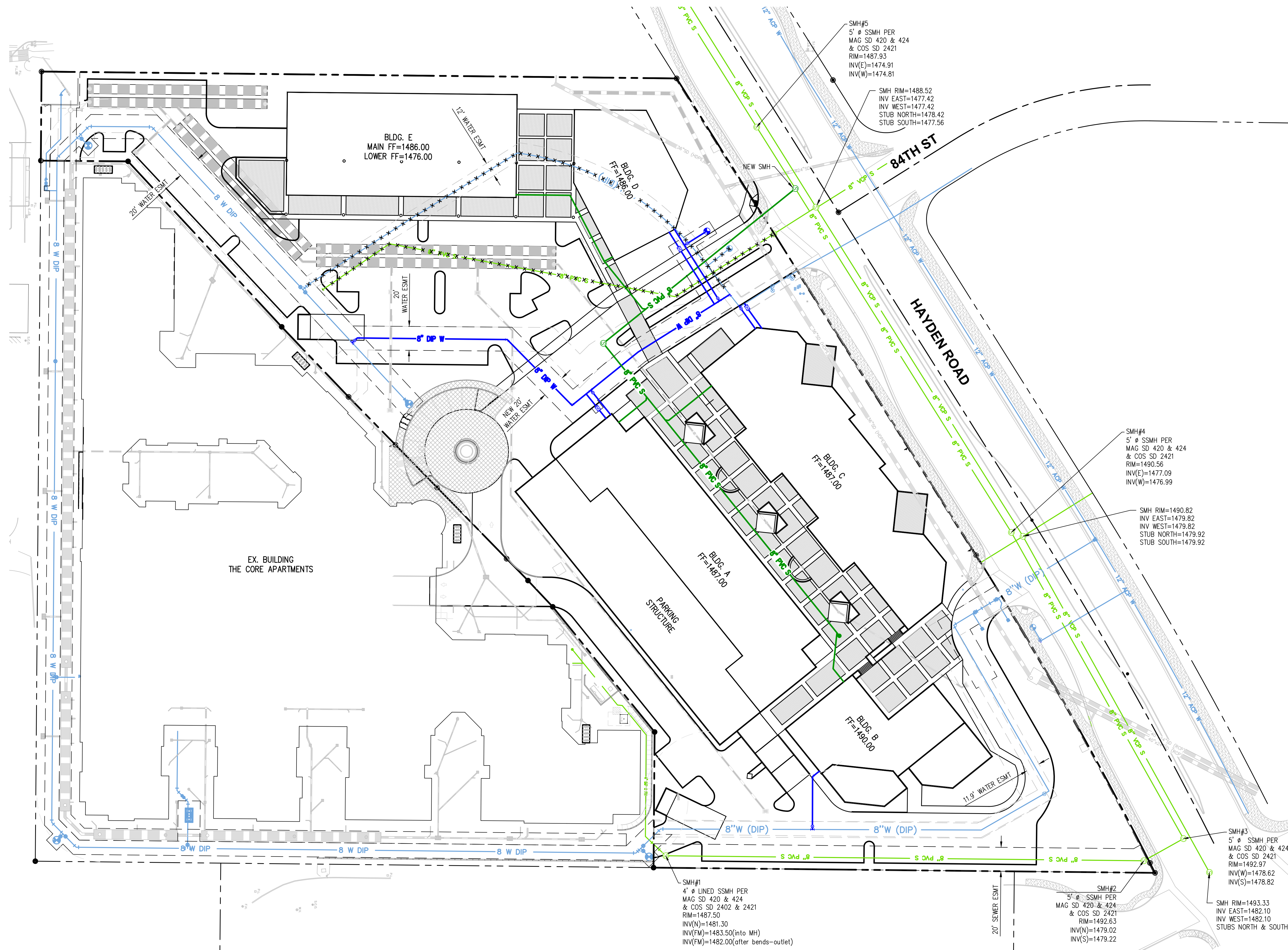

LEGEND	
	EXISTING WATER
	EXISTING SEWER
	PROPOSED WATER
	PROPOSED SEWER
	EXISTING WATER/SEWER TO BE ABANDONED
	FIRE HYDRANT
	SEWER MANHOLE

**PRELIMINARY
NOT FOR
CONSTRUCTION**





























FIGURE 2

NO	DESCRIPTION OF REVISIONS	DATE
1		
2		
3		

		6859 E Rembrandt Ave, #124 Mesa, AZ 85212 Ph: (480) 223-8573 landcorconsulting.com	
CORE CENTER PRELIMINARY SITE UTILITY PLAN		UTIL	
JOB NO.:	1615	DATE:	7/30/19
		1 OF 1	

LEGEND:

- Water Valve 
- Non-potable Water Valve 
- Fire Hydrant 
- Water Blowoff 
- Water Main Reducer 
- Water Sample Station 
- Water Air Release Valve 
- Non-potable Water Air Release Valve 
- Water Pressure Reducing Valve 
- Water Vault 
- Water Manhole 
- Non-Potable Water Manhole 
- Water Pump 
- Water Main 
- Non-Potable Water Main 
- Fire Line 
- Water Service 
- Non-Scottsdale Water Main 
- Sewer Manhole 
- Sewer Cleanout 
- Sewer Lift Station 
- Sewer Treatment Plant 
- Sewer Main - Gravity 
- Sewer Main - Force 
- Non-Scottsdale Sewer Main 
- Sewer Service 

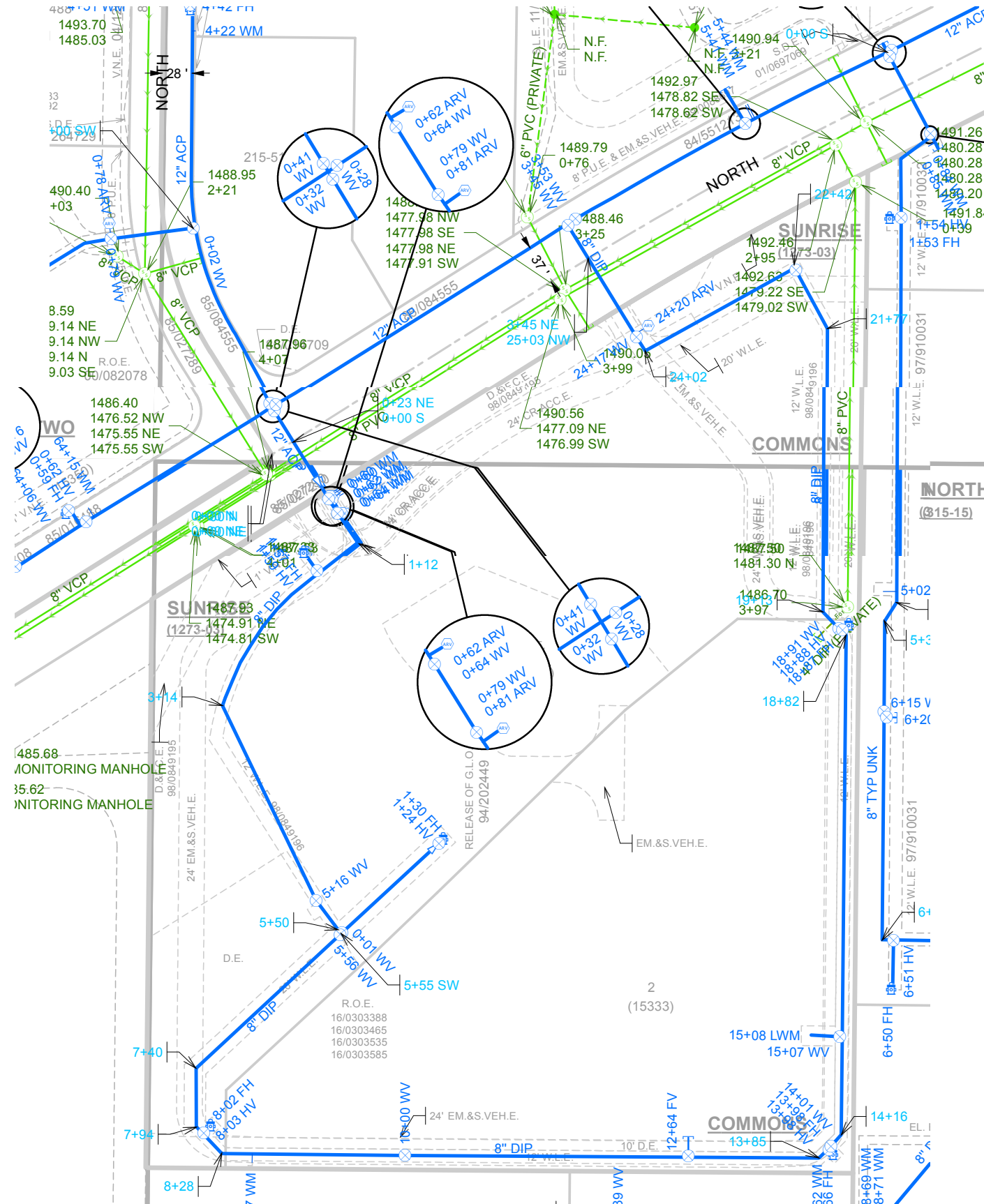

WATER & SEWER
 QUARTER SECTION MAP

FIGURE 3

APPENDIX B
WATER & SEWER CALCULATIONS



6859 E. Rembrandt Ave. #124
 Mesa, Arizona 85212
 (480) 223-8573

CORE CENTER
Water & Wastewater Basis of Design Report

Development Data:

Development: Core Center
 Report Prepared by Landcor Consulting, PC (480-223-8573)

Location: 15333 North Hayden Road
 Scottsdale, AZ 85260

Zoning: PCP-AMU

Land Use: Commercial

Population: See below

Sewer Impact:

Wastewater Source	Design Flow per Unit (GPD)	Unit	Quantity	ADF Average Daily Flow (GPD)	PF Peaking Factor	PH Peak Hour (GPD)
Building A						
Retail	0.5	GPD/SF	8,822	4,411	3	13,232
Restaurant	1.2	GPD/SF	8,822	10,586	6	63,515
Building B						
Retail	0.5	GPD/SF	3,564	1,782	3	5,346
Restaurant	1.2	GPD/SF	3,564	4,277	6	25,661
Office	0.4	GPD/SF	34,704	13,882	3	41,645
Building C						
Restaurant	1.2	GPD/SF	19,400	23,280	6	139,680
Office	0.4	GPD/SF	34,627	13,851	3	41,552
Building D						
Retail	0.5	GPD/SF	4,298	2,149	3	6,446
Restaurant	1.2	GPD/SF	4,298	5,157	6	30,942
Office	0.4	GPD/SF	10,826	4,330	3	12,991
Building E						
Retail	0.5	GPD/SF	8,256	4,128	3	12,384
Restaurant	1.2	GPD/SF	8,256	9,907	6	59,443
Office	0.4	GPD/SF	43,200	17,280	3	51,840
Total Flow =				115,019 GPD		504,678 GPD
				80 GPM		350 GPM
						0.77 cfs

Therefore, Q8" > Q (Peak Hour)

- d. Pipe flow velocity in feet per second (fps)
- e. Each pipe segment’s head loss rate (ft. /1,000ft or psi/ft.)
- f. PRVs: Upstream and downstream pressures (psi or HGL elevation)
- g. Tanks: Inflow and outflow (gpm)
- h. Shows all units for the values presented or provide a legend on the diagram page that indicates the units used

AVERAGE DAY WATER DEMANDS ⁽¹⁾							
IN GALLONS PER DAY (GPD) ⁽²⁾				IN GALLONS PER MINUTE (GPM) ⁽²⁾⁽³⁾			
Land Use	Inside Use	Outside Use	Total Use	Inside Use	Outside Use	Total Use	Units
Residential Demand per Dwelling Unit							
< 2 dwelling unit per acre (DU/ac)	208.9	276.7	485.6	0.30	0.39	0.69	per unit
2 – 2.9 DU/ac	193.7	276.7	470.4	0.27	0.39	0.66	per unit
3 – 7.9 DU/ac	175.9	72.3	248.2	0.25	0.11	0.36	per unit
8 – 11.9 DU/ac	155.3	72.3	227.6	0.22	0.11	0.33	per unit
12 – 22 DU/ac	155.3	72.3	227.6	0.22	0.11	0.33	per unit
High Density Condominium (condo)	155.3	30	185.3	0.22	0.05	0.27	per unit
Resort Hotel (includes site amenities)	401.7	44.6	446.3	0.56	0.07	0.63	per room
Service and Employment							
Restaurant	1.2	0.1	1.3	1.67E-03	1.39E-04	1.81E-03	per square foot (sq.ft.)
Commercial/ Retail	0.7	0.1	0.8	9.73E-04	1.39E-04	1.11E-03	per sq.ft.
Commercial High Rise	0.5	0.1	0.6	6.95E-04	1.39E-04	8.34E-04	per sq.ft.

AVERAGE DAY WATER DEMANDS ⁽¹⁾							
IN GALLONS PER DAY (GPD) ⁽²⁾				IN GALLONS PER MINUTE (GPM) ⁽²⁾⁽³⁾			
Office	0.5	0.1	0.6	6.95E-04	1.39E-04	8.34E-04	per sq.ft.
Institutional	670	670	1340	0.94	0.94	1.88	per acre
Industrial	873	154	1027	1.22	0.22	1.44	per acre
Research and Development	1092	192	1284	1.52	0.27	1.79	per acre
Special Use Areas							
Natural Area Open Space	0	0	0	0.0	0.0	0.0	per acre
Developed Open Space – Parks	0	1786	1786	0.0	2.49	2.49	per acre
Developed Open Space – Golf Course	0	4285	4285	0.0	5.96	5.96	per acre
Notes:							
(1) These values shall not be used directly for service line or water meter sizing.							
(2) Gallon per day values are provided for reference only. The instantaneous gallon per minute flow rates presented are intended for use in the required hydraulic modeling scenarios. The gpm values assume a 12-hour active water use period per 24-hour day. In large or specialty developments or master plans the hydraulic analysis criteria and parameters should be discussed with the Water Resources Department. Seasonal peaking should also be considered. Upon review, the Water Resources Department reserves the right to designate flows to be used in hydraulic modeling scenarios that may be different from those presented here.							
(3) The hydraulic modeling peaking factors used in select modeling scenarios are to be applied to the gpm values shown here. Max day and peak hour peaking factors can be found in Section 6-1.404.							

FIGURE 6-1.2 AVERAGE DAY WATER DEMANDS

Channel Report

8-in Sewer @ Peak Day Flow

Circular

Diameter (ft) = 0.67

Invert Elev (ft) = 10.00

Slope (%) = 1.00

N-Value = 0.013

Calculations

Compute by: Known Q

Known Q (cfs) = 0.93

Highlighted

Depth (ft) = 0.44

Q (cfs) = 0.930

Area (sqft) = 0.25

Velocity (ft/s) = 3.79

Wetted Perim (ft) = 1.27

Crit Depth, Yc (ft) = 0.46

Top Width (ft) = 0.64

EGL (ft) = 0.66

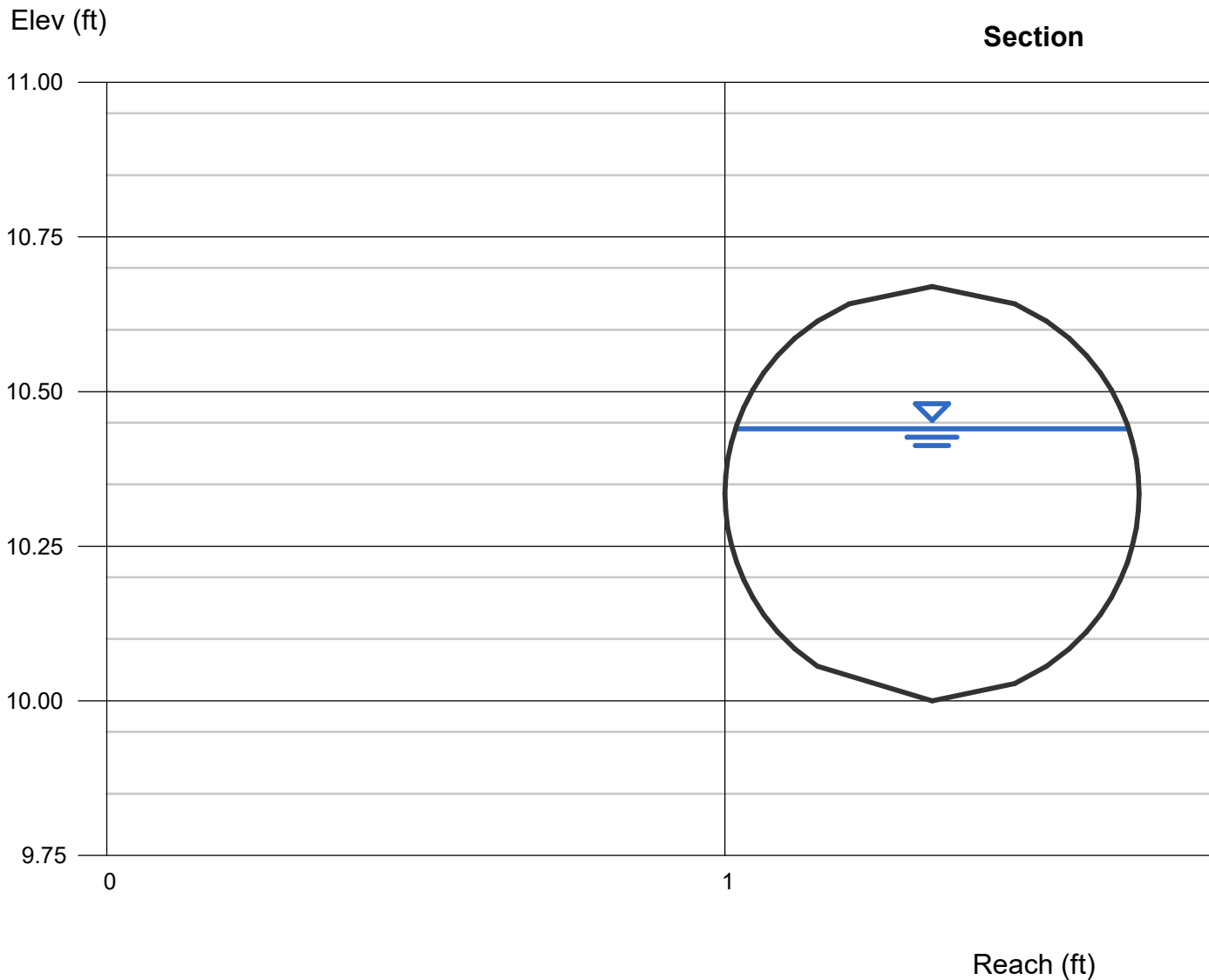

APPENDIX C
HYDRANT FLOW TEST REPORT
& FIRE FLOW INFORMATION

Arizona Flow Testing LLC

HYDRANT FLOW TEST REPORT

Project Name: 84th Street and Hayden
Project Address: 15333 North Hayden Road, Scottsdale, Arizona, 85260
Client Project No.: Not Provided
Arizona Flow Testing Project No.: 19214
Flow Test Permit No.: C58417
Date and time flow test conducted: May 30, 2019 at 7:00 AM
Data is current and reliable until: November 30, 2019
Conducted by: Floyd Vaughan – Arizona Flow Testing, LLC (480-250-8154)
Coordinated by: Jared Berry – City of Scottsdale-Inspector (602-541-4942)

Raw Test Data

Static Pressure: **79.0 PSI**
(Measured in pounds per square inch)

Residual Pressure: **64.0 PSI**
(Measured in pounds per square inch)

Pitot Pressure: **24.0 PSI**
(Measured in pounds per square inch)

Diffuser Orifice Diameter: One 4-inch Hose Monster
(Measured in inches)

Coefficient of Diffuser: 0.7875

Flowing GPM: **1,842 GPM**
(Measured in gallons per minute)

GPM @ 30 PSI: **3,491 GPM**
GPM @ 20 PSI: **3,859 GPM**

Data with 10% Safety Factor

Static Pressure: **71.1 PSI**
(Measured in pounds per square inch)

Residual Pressure: **56.1 PSI**
(Measured in pounds per square inch)

Distance between hydrants: Approx. 400 Feet

Main size: Not Provided

Flowing GPM: **1,842 GPM**

GPM @ 30 PSI: **3,086 GPM**
GPM @ 20 PSI: **3,571 GPM**

Flow Test Location

North ↑

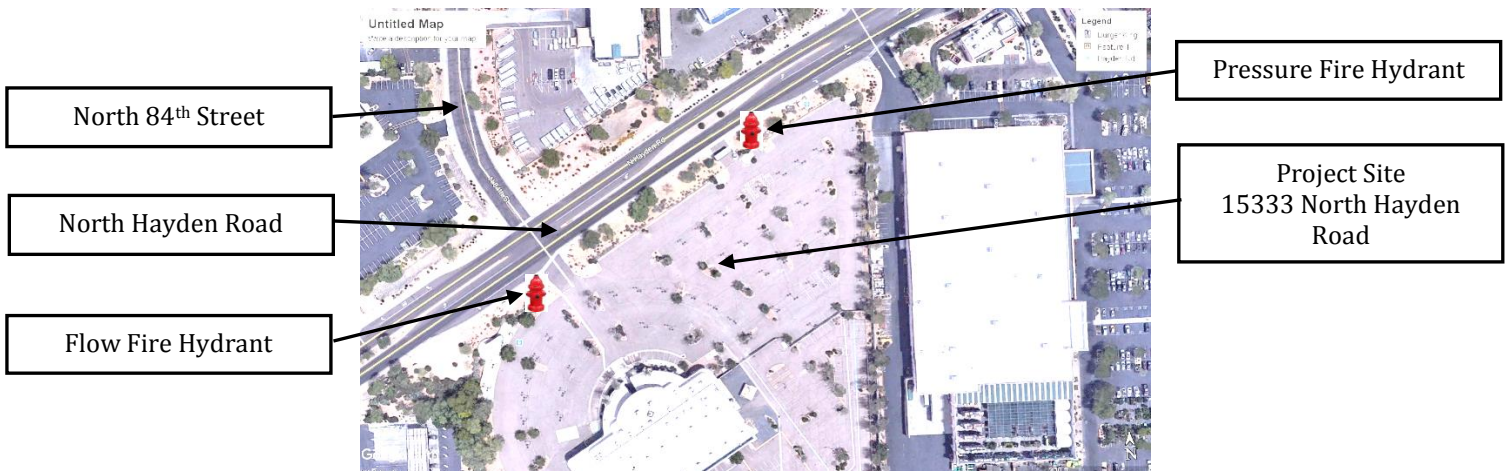

APPENDIX B

FIRE-FLOW REQUIREMENTS FOR BUILDINGS

The provisions contained in this appendix are not mandatory unless specifically referenced in the adopting ordinance.

SECTION B101 GENERAL

B101.1 Scope. The procedure for determining fire-flow requirements for buildings or portions of buildings hereafter constructed shall be in accordance with this appendix. This appendix does not apply to structures other than buildings.

SECTION B102 DEFINITIONS

B102.1 Definitions. For the purpose of this appendix, certain terms are defined as follows:

FIRE-FLOW. The flow rate of a water supply, measured at 20 pounds per square inch (psi) (138 kPa) residual pressure, that is available for fire fighting.

FIRE-FLOW CALCULATION AREA. The floor area, in square feet (m²), used to determine the required fire flow.

SECTION B103 MODIFICATIONS

B103.1 Decreases. The fire chief is authorized to reduce the fire-flow requirements for isolated buildings or a group of buildings in rural areas or small communities where the development of full fire-flow requirements is impractical.

B103.2 Increases. The fire chief is authorized to increase the fire-flow requirements where conditions indicate an unusual susceptibility to group fires or conflagrations. An increase shall not be more than twice that required for the building under consideration.

B103.3 Areas without water supply systems. For information regarding water supplies for fire-fighting purposes in rural and suburban areas in which adequate and reliable water supply systems do not exist, the *fire code official* is authorized to utilize NFPA 1142 or the *International Wildland-Urban Interface Code*.

SECTION B104 FIRE-FLOW CALCULATION AREA

B104.1 General. The fire-flow calculation area shall be the total floor area of all floor levels within the *exterior walls*, and under the horizontal projections of the roof of a building, except as modified in Section B104.3.

B104.2 Area separation. Portions of buildings which are separated by *fire walls* without openings, constructed in accordance with the *International Building Code*, are allowed to be considered as separate fire-flow calculation areas.

B104.3 Type IA and Type IB construction. The fire-flow calculation area of buildings constructed of Type IA and Type IB construction shall be the area of the three largest successive floors.

Exception: Fire-flow calculation area for open parking garages shall be determined by the area of the largest floor.

SECTION B105 FIRE-FLOW REQUIREMENTS FOR BUILDINGS

B105.1 One- and two-family dwellings, Group R-3 and R-4 buildings and townhouses. The minimum fire-flow and flow duration requirements for one- and two-family *dwellings*, Group R-3 and R-4 buildings and townhouses shall be as specified in Tables B105.1(1) and B105.1(2).

B105.2 Buildings other than one- and two-family dwellings, Group R-3 and R-4 buildings and townhouses. The minimum fire-flow and flow duration for buildings other than one- and two-family *dwellings*, Group R-3 and R-4 buildings and townhouses shall be as specified in Tables B105.2 and B105.1(2).

**TABLE B105.1(1)
REQUIRED FIRE-FLOW FOR ONE- AND TWO-FAMILY DWELLINGS, GROUP R-3 AND R-4 BUILDINGS AND TOWNHOUSES**

FIRE-FLOW CALCULATION AREA (square feet)	AUTOMATIC SPRINKLER SYSTEM (Design Standard)	MINIMUM FIRE-FLOW (gallons per minute)	FLOW DURATION (hours)
0-3,600	No automatic sprinkler system	1,000	1
3,601 and greater	No automatic sprinkler system	Value in Table B105.1(2)	Duration in Table B105.1(2) at the required fire-flow rate
0-3,600	Section 903.3.1.3 of the <i>International Fire Code</i> or Section P2904 of the <i>International Residential Code</i>	500	1/2
3,601 and greater	Section 903.3.1.3 of the <i>International Fire Code</i> or Section P2904 of the <i>International Residential Code</i>	1/2 value in Table B105.1(2)	1

For SI: 1 square foot = 0.0929 m², 1 gallon per minute = 3.785 L/m.

APPENDIX B

TABLE B105.1(2)
REFERENCE TABLE FOR TABLES B105.1(1) AND B105.2

FIRE-FLOW CALCULATION AREA (square feet)					FIRE-FLOW (gallons per minute) ^b	FLOW DURATION (hours)
Type IA and IB ^a	Type IIA and IIIA ^a	Type IV and V-A ^a	Type IIB and IIIB ^a	Type V-B ^a		
0-22,700	0-12,700	0-8,200	0-5,900	0-3,600	1,500	2
22,701-30,200	12,701-17,000	8,201-10,900	5,901-7,900	3,601-4,800	1,750	
30,201-38,700	17,001-21,800	10,901-12,900	7,901-9,800	4,801-6,200	2,000	
38,701-48,300	21,801-24,200	12,901-17,400	9,801-12,600	6,201-7,700	2,250	
48,301-59,000	24,201-33,200	17,401-21,300	12,601-15,400	7,701-9,400	2,500	
59,001-70,900	33,201-39,700	21,301-25,500	15,401-18,400	9,401-11,300	2,750	
70,901-83,700	39,701-47,100	25,501-30,100	18,401-21,800	11,301-13,400	3,000	3
83,701-97,700	47,101-54,900	30,101-35,200	21,801-25,900	13,401-15,600	3,250	
97,701-112,700	54,901-63,400	35,201-40,600	25,901-29,300	15,601-18,000	3,500	
112,701-128,700	63,401-72,400	40,601-46,400	29,301-33,500	18,001-20,600	3,750	
128,701-145,900	72,401-82,100	46,401-52,500	33,501-37,900	20,601-23,300	4,000	4
145,901-164,200	82,101-92,400	52,501-59,100	37,901-42,700	23,301-26,300	4,250	
164,201-183,400	92,401-103,100	59,101-66,000	42,701-47,700	26,301-29,300	4,500	
183,401-203,700	103,101-114,600	66,001-73,300	47,701-53,000	29,301-32,600	4,750	
203,701-225,200	114,601-126,700	73,301-81,100	53,001-58,600	32,601-36,000	5,000	
225,201-247,700	126,701-139,400	81,101-89,200	58,601-65,400	36,001-39,600	5,250	
247,701-271,200	139,401-152,600	89,201-97,700	65,401-70,600	39,601-43,400	5,500	
271,201-295,900	152,601-166,500	97,701-106,500	70,601-77,000	43,401-47,400	5,750	
295,901-Greater	166,501-Greater	106,501-115,800	77,001-83,700	47,401-51,500	6,000	
—	—	115,801-125,500	83,701-90,600	51,501-55,700	6,250	
—	—	125,501-135,500	90,601-97,900	55,701-60,200	6,500	
—	—	135,501-145,800	97,901-106,800	60,201-64,800	6,750	
—	—	145,801-156,700	106,801-113,200	64,801-69,600	7,000	
—	—	156,701-167,900	113,201-121,300	69,601-74,600	7,250	
—	—	167,901-179,400	121,301-129,600	74,601-79,800	7,500	
—	—	179,401-191,400	129,601-138,300	79,801-85,100	7,750	
—	—	191,401-Greater	138,301-Greater	85,101-Greater	8,000	

For SI: 1 square foot = 0.0929 m², 1 gallon per minute = 3.785 L/m, 1 pound per square inch = 6.895 kPa.

- a. Types of construction are based on the *International Building Code*.
- b. Measured at 20 psi residual pressure.

TABLE B105.2
REQUIRED FIRE-FLOW FOR BUILDINGS OTHER THAN ONE- AND TWO-FAMILY DWELLINGS, GROUP R-3 AND R-4 BUILDINGS AND TOWNHOUSES

AUTOMATIC SPRINKLER SYSTEM (Design Standard)	MINIMUM FIRE-FLOW (gallons per minute)	FLOW DURATION (hours)
No automatic sprinkler system	Value in Table B105.1(2)	Duration in Table B105.1(2)
Section 903.3.1.1 of the <i>International Fire Code</i>	25% of the value in Table B105.1(2) ^a	Duration in Table B105.1(2) at the reduced flow rate
Section 903.3.1.2 of the <i>International Fire Code</i>	25% of the value in Table B105.1(2) ^b	Duration in Table B105.1(2) at the reduced flow rate

For SI: 1 gallon per minute = 3.785 L/m.

- a. The reduced fire-flow shall be not less than 1,000 gallons per minute.
- b. The reduced fire-flow shall be not less than 1,500 gallons per minute.

B105.3 Water supply for buildings equipped with an automatic sprinkler system. For buildings equipped with an approved *automatic sprinkler system*, the water supply shall be capable of providing the greater of:

1. The *automatic sprinkler system* demand, including hose stream allowance.
2. The required fire-flow.

SECTION B106 REFERENCED STANDARDS

ICC	IBC—15	International Building Code	B104.2,
			Tables
ICC	IFC—15	International Fire Code	B105.1(1) and B105.2
ICC	IWUIC—15	International Wildland- Urban Interface Code	B103.3
ICC	IRC—15	International Residential Code	Table B105.1(1)
NFPA	1142—12	Standard on Water Supplies for Suburban and Rural Fire Fighting	B103.3

APPENDIX D
EXCERPTS FROM
WATER DISTRIBUTION SYSTEM REPORT FOR
IMPACT CHURCH/SUNRISE COMMONS

**WATER DISTRIBUTION
SYSTEM REPORT
FOR
IMPACT CHURCH/SUNRISE COMMONS
SCOTTSDALE, ARIZONA**

January 30, 2014
WP #113725

Prepared For: **Sunrise Luxury Living, LLC.**
Mr. James Hinton
5773 Woodway Drive
Suite 415
Houston, Texas 77057
Phone: (832) 443-7052

Submitted To: **Mr. Douglas L. Mann, P.E.**
Water Resources Engineer
City of Scottsdale
9388 East San Salvador Drive
Scottsdale, AZ 85258
Phone: (480) 312-5636
Fax: (480) 312-5615

Prepared By: **Wood, Patel & Associates, Inc.**
2051 West Northern Avenue
Suite 100
Phoenix, AZ 85021
Phone: (602) 335-8500
Fax: (602) 335-8580
Website: www.woodpatel.com
Contact: Mr. Edward M. Rajnovich, P.E.

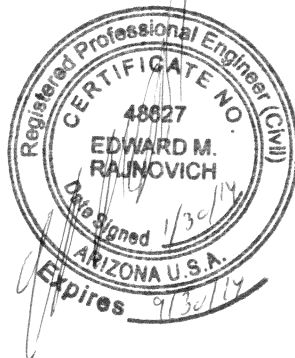

Darrel E. Wood, P.E., R.L.S.
Ashok C. Patel, P.E., R.L.S., CFM
James S. Campbell, P.E.
Thomas R. Gettings, R.L.S.
Michael T. Young, P.E.
Jeffrey R. Minch, P.E.
Robert D. Gofonia, P.E., R.L.S.
Patrick W. Marum, P.E.
Kenneth L. Knickerbocker, P.E., R.L.S.
Darin L. Moore, P.E.
John M. Bulka, P.E.
Darrell D. Smith, P.E.
Daniel J. Cronin, PMP, LEED AP, CDT
James G. Taillon, CFM
Daniel W. Matthews, P.E.
Christopher A. Salas, P.E.
R. Stuart Barney, P.E.
Kathy M. Svecchovsky, R.L.S.
Joseph C. Daconta, P.E.
Shane D. McClara, P.E.
Ken S. Snow, P.E.
Robert W. Schlicher, P.E.
Ethan A. Boyle, P.E.
Michael R. Havill, P.E., R.L.S.
Abel Becerra, R.L.S.
Cesar Castillo, P.E.
Edward M. Rajnovich, P.E.
James L. Kary, P.E.
Mark A. Everett, P.E., CFM
Ronald F. Martinez, P.E.

January 30, 2014

Mr. Douglas L. Mann, P.E.
Water Resources Engineer
City of Scottsdale
9388 East San Salvador Drive
Scottsdale, AZ 85258

Phone: (480) 312- 5636
Fax: (480) 312-5615

Re: **Impact Church/Sunrise Commons**
Water Distribution System Report
WP #113725

Dear Mr. Mann:

The proposed Impact Church/Sunrise Commons development is located entirely within the City of Scottsdale. More specifically the project is located east of Hayden Road between north Hayden Road and north Northsight Boulevard. Exhibit 1 provides a vicinity map for the project. The existing approximately 11.2 acre property was previously a car dealership. The proposed development will involve dividing the property into two parcels. The northern parcel will consist of a church project, and the southern portion will consist of a 311 unit, 4 story luxury apartment project with a 5-1/2 story parking garage (see attached Conceptual Site Plan by Davis Architecture). The overall property will require a general plan amendment and a zone change from the existing C-4 Commercial zone. This Water Distribution System Report has been prepared to support the general plan amendment and rezoning submittal to the City of Scottsdale.

Based on our understanding of the intended use of the proposed facilities, potable water demands for the apartment building and church have been modeled using the City's water demand criteria for residential use (condominiums) and office use, respectively. Table 1 below summarizes the modeled land uses generating water demand for the Impact Church/Sunrise Commons project.

Table 1 – Impact Church/Sunrise Commons Modeled Land Uses

Description	Residential Dwelling Units ¹	Building (Sq. Ft.) ^{2,3}
Church Building	N/A	69,500
Apartments – Garage Building (5-1/2 stories)	N/A	181,940 total
Apartments – Building (4 stories)	311	330,804 total

Notes:

1. Source: Architect furnished dwelling unit count
2. Source: Architect furnished area of church building
3. Source: Architect furnished area of garage and apartment building



Impact Church/Sunrise Commons
Water Distribution System Report
WP# 113725

The design criteria used to estimate potable water demands and evaluate system hydraulics are based on Wood/Patel's understanding of the requirements listed in the City of Scottsdale Design Standards and Policies Manual. The following is a summary of the primary design criteria utilized:

- Average-Day Water Demand, Residential (condominiums): 185.3 gpd/DU *
- Average-Day Water Demand, Office: 0.60 gpd/SF *
- Fire Flow Requirements: 3,800 gpm**
- Maximum-Day Demand: 2.0 x Ave.
- Peak-Hour Demand: 3.5 x Ave.
- Minimum Residual Pressure, Peak-Hour: 50 psi
- Minimum Residual Pressure, Maximum-Day + Fire Flow: 30 psi
- Maximum System Pressure: 120 psi
- Maximum Pipe Head Loss, Maximum-Day Demand: 8 ft / 1,000 ft.
- Maximum Pipe Head Loss, Peak-Hour Demand: 10 ft / 1,000 ft.
- Minimum Pipe Diameter, Public Water Line: 8 inches

Abbreviations: gpd = gallons per day; DU = dwelling unit; SF = square feet;
Ave. = average day demand; psi = pounds per sq. inch

* Includes both inside and outside use per Figure 6.1-2, COS Design Standards & Policies Manual

**3,800 gpm fire flow based on 53% reduction (refer to calculations in the Appendix)

Domestic and fire protection water demands for the proposed development will be served by the existing 12-inch public water line in Hayden Road. An existing 8-inch waterline loop currently exists on the property, with one (1) 12-inch and one (1) 6-inch connection to the existing 12-inch public main in Hayden Road. A portion of the existing 8-inch onsite loop as well as the existing 6-inch connection will be removed as part of the proposed development. The proposed system will utilize the existing 12-inch connection and a portion of the 8-inch loop on the north portion of the site, and will extend an 8-inch public waterline loop from this point around the south and east portions of the project before reconnecting at the east side of the property. Additionally, the 6-inch connection to the 12-inch public main will be removed and replaced with an 8-inch line. All proposed improvements will be at the developers cost.

Private domestic water and sprinkler services will extend from the proposed onsite public waterline loop to the proposed buildings. Backflow prevention devices are required on all private services, with domestic backflow devices located external to the buildings and fire sprinkler backflow devices located within proposed fire riser rooms.

In addition to the fire sprinkler systems, fire protection for the proposed development will be provided by a combination of four (4) proposed public fire hydrants and the two (2) existing public fire hydrants. Proposed hydrants have been strategically located throughout the development to provide adequate coverage.

The proposed public waterline loop, as well as the proposed fire hydrants, will be located in a contiguous 20-foot wide public waterline easement to be dedicated to the City of Scottsdale by a plat. Some of the existing waterline easements and waterlines will be abandoned.

Impact Church/Sunrise Commons
Water Distribution System Report
WP# 113725

The Average Day water demand for the proposed Impact Church/Sunrise Commons project is projected to be approximately 99,328 gallons per day (gpd), or 69 gallons per minute (gpm). Maximum Day Demand and Peak Hour Demand are projected to be 138 gpm and 241 gpm, respectively (see attached calculations).

WaterCAD Version 7.0, by Haestad Methods, was utilized to analyze the proposed water distribution system. Results from a fire hydrant flow test conducted on October 31, 2013 by Arizona Testing, LLC. were utilized to simulate the COS water-supply for the project area. It is important to add that the design of the existing 8-inch ductile iron pipe that will remain onsite was specified in the improvement plans for Sun Pontiac by Gilbertson Associates prepared in 1998. The existing ductile iron pipe is anticipated to be in good condition based upon the material type specified (poly-wrapped DIP).

The hydraulic-modeling results indicate that the proposed system is capable of delivering peak-hour demands totaling 241 gpm to the overall Impact Church/Sunrise commons project, with pressures ranging from 79.8 to 83.7 pounds per square inch (psi). Fire-flow results indicate that residual pressures exceed 30 psi within the project site with 3,800 gpm fire hydrant flows during maximum-day demand. It is important to add that a 53 percent reduction was applied to the fire flow requirements due to the proposed sprinkler system. Hydraulic-modeling results, calculations, and exhibits involved in the water system analysis are attached.

Thank you for your review of the water distribution system report provided for Impact Church/Sunrise Commons. Please feel free to contact me if you have any questions.

Sincerely,

Wood, Patel & Associates, Inc.

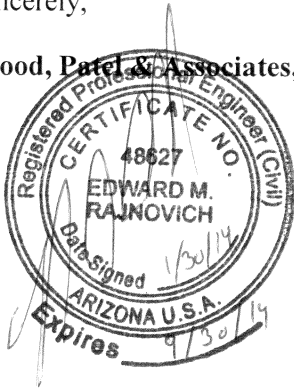

Edward M. Rajnovich, P.E.
Project Engineer

APPENDIX E
EXCERPTS FROM
WASTEWATER COLLECTION SYSTEM REPORT FOR
IMPACT CHURCH/SUNRISE COMMONS

**WASTEWATER COLLECTION
SYSTEM REPORT
FOR
IMPACT CHURCH/SUNRISE COMMONS
SCOTTSDALE, ARIZONA**

February 6, 2014
WP# 113725

Prepared For: **Impact Church**
Mr. Andre Wadsworth
15650 North 83rd Street
Scottsdale, Arizona 85260
Phone: (480) 926-6752

Submitted To: **Mr. Douglas L. Mann, P.E.**
Water Resources Engineer
City of Scottsdale
9388 East San Salvador Drive
Scottsdale, AZ 85258
Phone: (480) 312-5636
Fax: (480) 312-5615

Prepared By: **Wood, Patel & Associates, Inc.**
2051 West Northern Avenue
Suite 100
Phoenix, AZ 85021
Phone: (602) 335-8500
Fax: (602) 335-8580
Website: www.woodpatel.com
Contact: Mr. Edward M. Rajnovich, P.E.



Darrel E. Wood, P.E., R.L.S.
Ashok C. Patel, P.E., R.L.S., CFM
James S. Campbell, P.E.
Thomas R. Gettings, R.L.S.
Michael T. Young, P.E.
Jeffrey R. Minch, P.E.
Robert D. Gofonia, P.E., R.L.S.
Patrick W. Marum, P.E.
Kenneth L. Knickerbocker, P.E., R.L.S.
Darin L. Moore, P.E.
John M. Bulka, P.E.
Darrell D. Smith, P.E.
Daniel J. Cronin, PMP, LEED AP, CDT
James G. Taillon, CFM
Daniel W. Matthews, P.E.
Christopher A. Salas, P.E.
R. Stuart Barney, P.E.
Kathy M. Svehovsky, R.L.S.
Joseph C. Daconta, P.E.
Shane D. McClara, P.E.
Ken S. Snow, P.E.
Robert W. Schlicher, P.E.
Ethan A. Boyle, P.E.
Michael R. Havill, P.E., R.L.S.
Abel Becerra, R.L.S.
Cesar Castillo, P.E.
Edward M. Rajnovich, P.E.
James L. Kary, P.E.
Mark A. Everett, P.E., CFM
Ronald F. Martinez, P.E.

February 6, 2014

Mr. Douglas L. Mann, P.E.
Water Resources Engineer
City of Scottsdale
9388 East San Salvador Drive
Scottsdale, AZ 85258
Phone: (480) 312- 5636
Fax: (480) 312-5615

Re: **Impact Church/Sunrise Commons**
Wastewater Collection System Report
WP #113725

Dear Mr. Mann:

The proposed Impact Church/Sunrise Commons development is located entirely within the City of Scottsdale. More specifically the project is located east of Hayden Road between north Hayden Road and north Northsight Boulevard. Exhibit 1 provides a vicinity map for the project. The existing approximately 11.2 acre property was previously a car dealership. The proposed development of this project will involve dividing the property into two parcels. The northern parcel will consist of a church project on approximately 6.4 acres, and the southern portion will consist of a 311 unit, 4 story luxury apartment project with a 5-1/2 story parking garage (see attached Conceptual Site Plan by Davis Architecture) on approximately 4.8 acres. The overall property will require a general plan amendment and a zone change from the existing C-4 Commercial zone. This Sewer Basis of Design Report has been prepared to support the general plan amendment and rezoning submittal to the City of Scottsdale.

Based on the conceptual site plan and our understanding of the intended use of the proposed facilities, the wastewater demands for the apartment complex and church have been modeled using the City's sewer demand criteria for residential use (high density condominiums) and school use, respectively. These uses most closely resemble the apartment and church uses proposed for this project.

Proposed uses generating wastewater flows include a 69,500± square feet church building and 311 apartment units. The 311 apartment units consist of 31 studio units, 175 one bedroom units, and 105 two bedroom units. The wastewater demand for the leasing office was modeled as a cultural use. The church and apartment demands have been modeled using the City's sewer demands for school use and high density condominium use, respectively (as mentioned previously).

The school peaking factor of 6.0 is not applicable for church use. A peaking factor for the church use of 4.0 is presented below. This is based on peaking factors referenced in Metcalf and Eddy. Table 1 below summarizes the modeled land uses generating wastewater flows for both the church and the apartment properties.



Table 1 – Overall Modeled Land Uses

Description	Residential Dwelling Units¹	People²
Church Building	N/A	1,180
Apartments	311 (416 rooms)	N/A

Notes:

1. Source: Client furnished site plan.
2. Source: Architect furnished number of people church auditorium is designed for.

The design criteria used to estimate wastewater flows and evaluate system hydraulics are based on Wood/Patel’s understanding of the requirements listed in the City of Scottsdale Design Standards and Policies Manual. The following is a summary of the primary design criteria utilized:

- Average-Day Wastewater Flows, Condominiums: 140 gpd/room
- Peaking Factor, Condominiums: 4.50
- Average-Day Wastewater Flow, School: 30 gpd/person
- Peaking Factor, Church: 4.0
- Average-Day Wastewater Flow, Cultural: 0.1 gpd/person
- Peaking Factor, Cultural: 3.0
- Minimum Mean Full-Flow Velocity: 2.50 ft/s
- Maximum Peak Flow d/D Ratio (6”-8” dia. Sewers): $d/D = 0.65$
- Minimum Pipe Diameter (service): 6 inches

 * Abbreviations: gpd = gallons per day

In addition, to account for infiltration and inflow, a design criterion of 250 gallons per day per acre was utilized for the onsite sewer analysis.

Wastewater flows from the proposed Impact Church/Sunrise Commons project will discharge into the City of Scottsdale’s public sewer system via the existing 8-inch sanitary sewer line in Hayden Road. Wastewater from the church site will be conveyed, via gravity flow, north to an existing sewer manhole at the western site driveway. Wastewater from the apartment site will be pumped by a force main to a proposed onsite, gravity sewer along the east property boundary. The gravity sewer will convey the wastewater north to the existing 8-inch sanitary sewer in Hayden. Please refer to the attached Preliminary Sewer Exhibit. The design of the onsite force main system for the apartments will be presented to the City of Scottsdale in the final construction design documents

Currently, the projected peak wet-weather flow rate for the Impact Church project is 143,200 gallons per day (gpd). The projected peak wet-weather flow rate for the luxury apartments is 264,050 gallons per day (gpd). The projected peak wet-weather flow rate for the overall site is 407,250 gallons per day (gpd). The proposed six-inch onsite service from the church property and the proposed eight-inch diameter main from the apartment complex to Hayden Road will have adequate capacity to serve the proposed development.

February 6, 2014

The proposed sewer slopes, projected peak flow rates, and pipe flow capacities are summarized on the attached spreadsheets. In summary, the proposed onsite sewer system for the overall development is believed to be compliant with the requirements of the City of Scottsdale.

The City of Scottsdale had expressed concerns that the capacity of the existing public 8-inch sanitary sewer in Hayden Road may not have the capacity to accept the peak discharge from the development. The area of concern is the reach of the Hayden sewer from approximately 300 feet south of North 82nd Street to East Raintree Drive. The City of Scottsdale has required that this segment of the Hayden sewer be monitored to determine the maximum existing flowrate. This monitoring was performed from January 22, 2014 to February 3, 2014 at an existing manhole approximately 300 ft north of East Raintree Drive.

The offsite sewer capacity analysis conservatively assumes that the maximum flows in the existing Hayden sewer and the projected maximum flows from the church and the apartments occur at the same time. It is not advantageous to overdesign sewer systems due to unnecessary costs and inadequate flow to move solids through the system. The City of Scottsdale requires the use of a Manning's n value of 0.013. A reasonable range for a Manning's value for vitrified clay pipe is 0.09 to 0.013 based on acceptable industry standards. Hence, a Manning's value of 0.013 also adds more conservatism to the analysis

It was determined that there are two reaches of sanitary sewer pipe (within the area of concern) that do not have the capacity to convey the existing maximum flow plus the site generated flow at a depth to pipe diameter ratio of 0.65. The developer will be required to design, construct, and pay for the offsite improvements necessary to provide a parallel relief sewer along these two pipe reaches. The subject pipe reaches are from East Raintree Drive to East Butherus Drive.

Thank you for your review of the proposed wastewater collection system provided for Impact Church/Sunrise Commons. Please feel free to contact me if you have any questions.

Sincerely,

Wood, Patel & Associates, Inc.

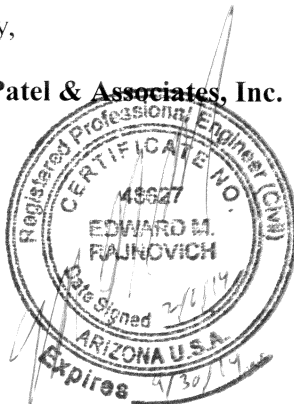

Edward M. Rajnovich, P.E.
Project Engineer

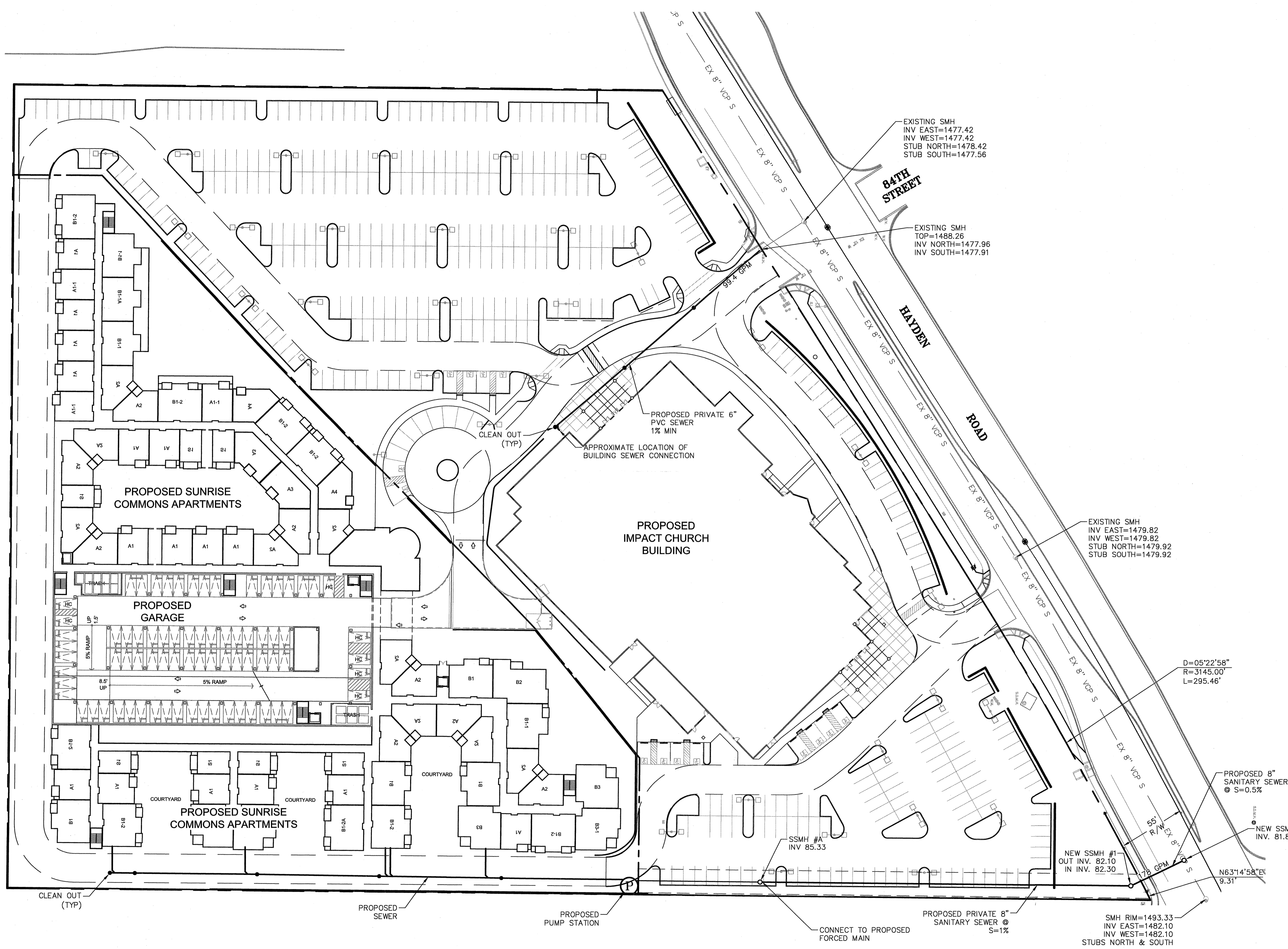

LEGEND

- PROPOSED MANHOLE
- PROPOSED CLEAN OUT
- EXISTING MANHOLE
- PROPOSED SEWER PIPE
- S- EXISTING SEWER PIPE
- - - SITE BOUNDARY

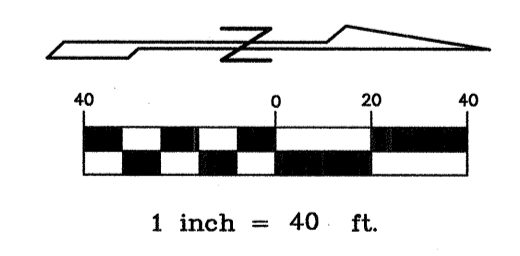

SUNRISE COMMONS/IMPACT CHURCH

SEWER EXHIBIT

DATE: 2/4/14

WOOD/PATEL
 CIVIL ENGINEERS
 HYDROLOGISTS
 LAND SURVEYORS
 CONSTRUCTION MANAGERS
 (800) 333-8500
 www.woodpatel.com
 PROJECT: 1401-1201

EXISTING SMH
 INV EAST=1477.42
 INV WEST=1477.42
 STUB NORTH=1478.42
 STUB SOUTH=1477.56

EXISTING SMH
 TOP=1488.26
 INV NORTH=1477.96
 INV SOUTH=1477.91

EXISTING SMH
 INV EAST=1479.82
 INV WEST=1479.82
 STUB NORTH=1479.92
 STUB SOUTH=1479.92

D=05°22'58"
 R=3145.00
 L=295.46'

PROPOSED 8"
 SANITARY SEWER
 S=0.5%

NEW SSMH #2
 INV. 81.85±

NEW SSMH #1
 OUT INV. 82.10
 IN INV. 82.30

SMH RIM=1493.33
 INV EAST=1482.10
 INV WEST=1482.10
 STUBS NORTH & SOUTH

SSMH #A
 INV 85.33

CONNECT TO PROPOSED
 FORCED MAIN

PROPOSED PRIVATE 8"
 SANITARY SEWER
 S=1%

PROPOSED
 PUMP STATION

PROPOSED
 SEWER

CLEAN OUT
 (TYP)

PROPOSED IMPACT CHURCH
 BUILDING

PROPOSED SUNRISE
 COMMONS APARTMENTS

PROPOSED
 GARAGE

PROPOSED SUNRISE
 COMMONS APARTMENTS

PROPOSED PRIVATE 6"
 PVC SEWER
 1% MIN

CLEAN OUT
 (TYP)

COURTYARD

COURTYARD

COURTYARD

COURTYARD

COURTYARD

COURTYARD

COURTYARD

COURTYARD

COURTYARD

COURTYARD

COURTYARD

COURTYARD

COURTYARD

SEWER FLOW MONITORING RESULTS

Client: Wood Patel and Associates

Site: Manhole on NB side of Hayden, 300' N of Raintree

Start Date: 1/22/2014

End Date: 2/3/2014

Pipe Size: 8"

Slope: 0.007 '/'

Roughness: 0.013



Date	Time	Level (in.)	Flow 1 (gpm)
22-Jan-14	5:45	1.12	18.94
22-Jan-14	6:00	1.09	17.98
22-Jan-14	6:15	1.16	20.67
22-Jan-14	6:30	1.38	29.35
22-Jan-14	6:45	1.16	20.40
22-Jan-14	7:00	1.17	20.81
22-Jan-14	7:15	1.24	23.41
22-Jan-14	7:30	1.40	30.11
22-Jan-14	7:45	1.33	27.10
22-Jan-14	8:00	1.22	22.62
22-Jan-14	8:15	1.36	28.50
22-Jan-14	8:30	1.74	47.20
22-Jan-14	8:45	1.85	53.34
22-Jan-14	9:00	1.71	45.53
22-Jan-14	9:15	1.85	53.35
22-Jan-14	9:30	1.97	60.15
22-Jan-14	9:45	2.05	65.44
22-Jan-14	10:00	2.51	96.56
22-Jan-14	10:15	3.14	147.93
22-Jan-14	10:30	2.95	131.14
22-Jan-14	10:45	2.70	110.96
22-Jan-14	11:00	2.62	104.99
22-Jan-14	11:15	2.61	104.03
22-Jan-14	11:30	2.73	113.75

Date	Maximum GPM	Minimum GPM	Total (gal x 100)
22/JAN/14 Wed	13:45 166.96	6:00 17.98	883.45
23/JAN/14 Thu	14:00 169.77	2:45 15.76	949.87
24/JAN/14 Fri	14:30 166.23	6:00 19.15	1,023.76
25/JAN/14 Sat	11:00 168.81	5:00 19.07	965.81
26/JAN/14 Sun	17:30 140.03	6:30 13.69	761.94
27/JAN/14 Mon	15:00 155.09	5:30 16.00	871.86
28/JAN/14 Tue	13:45 160.48	5:15 15.00	928.37
29/JAN/14 Wed	12:00 169.08	5:00 18.74	1,034.97
30/JAN/14 Thu	14:15 162.38	5:15 20.67	968.91
31/JAN/14 Fri	11:45 175.51	4:15 18.94	1,041.55
01/FEB/14 Sat	15:15 3.49	5:15 1.06	2.04
02/FEB/14 Sun	15:00 2.95	5:30 1.11	1.81
03/FEB/14 Mon	3:15 1.72	5:00 1.15	1.35

Full Span Summary	
Level (in.)	Flow 1 (gpm)
Minimum:	0.954 13.69
	6:30 6:30
	26-Jan 26-Jan
Maximum:	3.489 178.749
	15:15 15:15

22-Jan-14	11:45	3:29	161.24
22-Jan-14	12:00	3:30	161.51
22-Jan-14	12:15	3:25	156.88
22-Jan-14	12:30	2:73	113.67
22-Jan-14	12:45	2:77	117.15
22-Jan-14	13:00	2:74	114.40
22-Jan-14	13:15	3:16	149.67
22-Jan-14	13:30	3:29	160.36
22-Jan-14	13:45	3:36	166.96
22-Jan-14	14:00	2:72	112.99
22-Jan-14	14:15	2:72	113.25
22-Jan-14	14:30	2:73	113.44
22-Jan-14	14:45	2:89	126.78
22-Jan-14	15:00	3:12	145.88
22-Jan-14	15:15	3:26	157.72
22-Jan-14	15:30	3:32	163.59
22-Jan-14	15:45	2:64	106.67
22-Jan-14	16:00	2:51	97.09
22-Jan-14	16:15	2:57	101.25
22-Jan-14	16:30	2:40	88.67
22-Jan-14	16:45	2:46	93.37
22-Jan-14	17:00	2:88	125.75
22-Jan-14	17:15	3:13	146.90
22-Jan-14	17:30	2:96	132.46
22-Jan-14	17:45	2:10	68.15
22-Jan-14	18:00	2:32	82.90
22-Jan-14	18:15	2:56	100.59
22-Jan-14	18:30	2:30	81.69
22-Jan-14	18:45	2:21	75.81
22-Jan-14	19:00	2:18	73.58
22-Jan-14	19:15	2:67	108.87
22-Jan-14	19:30	2:48	94.78
22-Jan-14	19:45	1:74	46.99
22-Jan-14	20:00	1:67	43.10

1-Feb	1-Feb
Average:	1.957
Total Flow:	11321.65 (gal) x100
	65.519

22-Jan-14	20:15	1.73	46.51
22-Jan-14	20:30	1.72	45.97
22-Jan-14	20:45	1.60	39.71
22-Jan-14	21:00	1.69	44.21
22-Jan-14	21:15	1.64	41.73
22-Jan-14	21:30	1.73	46.32
22-Jan-14	21:45	1.54	36.61
22-Jan-14	22:00	1.50	34.60
22-Jan-14	22:15	1.40	30.28
22-Jan-14	22:30	1.49	34.54
22-Jan-14	22:45	1.48	33.92
22-Jan-14	23:00	1.44	32.12
22-Jan-14	23:15	1.38	29.49
22-Jan-14	23:30	1.47	33.54
22-Jan-14	23:45	1.48	33.95
23-Jan-14	0:00	1.34	27.86
23-Jan-14	0:15	1.35	28.00
23-Jan-14	0:30	1.29	25.54
23-Jan-14	0:45	1.18	21.29
23-Jan-14	1:00	1.21	22.34
23-Jan-14	1:15	1.09	18.04
23-Jan-14	1:30	1.22	22.94
23-Jan-14	1:45	1.24	23.48
23-Jan-14	2:00	1.16	20.66
23-Jan-14	2:15	1.07	17.42
23-Jan-14	2:30	1.05	16.82
23-Jan-14	2:45	1.02	15.76
23-Jan-14	3:00	1.06	17.14
23-Jan-14	3:15	1.25	24.04
23-Jan-14	3:30	1.32	26.85
23-Jan-14	3:45	1.16	20.61
23-Jan-14	4:00	1.14	20.00
23-Jan-14	4:15	1.13	19.63
23-Jan-14	4:30	1.24	23.47

23-Jan-14	4:45	1.13	19.34
23-Jan-14	5:00	1.12	19.24
23-Jan-14	5:15	1.09	18.11
23-Jan-14	5:30	1.18	21.43
23-Jan-14	5:45	1.17	21.03
23-Jan-14	6:00	1.03	16.08
23-Jan-14	6:15	1.05	16.55
23-Jan-14	6:30	1.07	17.33
23-Jan-14	6:45	1.13	19.32
23-Jan-14	7:00	1.09	18.04
23-Jan-14	7:15	1.03	16.14
23-Jan-14	7:30	1.29	25.43
23-Jan-14	7:45	1.47	33.41
23-Jan-14	8:00	1.36	28.48
23-Jan-14	8:15	1.36	28.58
23-Jan-14	8:30	1.54	36.98
23-Jan-14	8:45	2.45	92.26
23-Jan-14	9:00	2.42	90.17
23-Jan-14	9:15	1.80	50.52
23-Jan-14	9:30	1.97	60.26
23-Jan-14	9:45	2.00	62.31
23-Jan-14	10:00	2.53	98.62
23-Jan-14	10:15	2.58	102.12
23-Jan-14	10:30	2.68	110.08
23-Jan-14	10:45	2.78	117.72
23-Jan-14	11:00	2.83	121.61
23-Jan-14	11:15	2.57	101.64
23-Jan-14	11:30	2.57	101.59
23-Jan-14	11:45	2.52	97.62
23-Jan-14	12:00	2.81	120.04
23-Jan-14	12:15	3.33	164.19
23-Jan-14	12:30	3.30	162.04
23-Jan-14	12:45	3.29	160.89
23-Jan-14	13:00	2.88	125.86

23-Jan-14	13:15	2.73	113.71
23-Jan-14	13:30	2.76	115.89
23-Jan-14	13:45	3.08	142.76
23-Jan-14	14:00	3.39	169.77
23-Jan-14	14:15	3.36	167.27
23-Jan-14	14:30	3.16	149.36
23-Jan-14	14:45	2.73	113.74
23-Jan-14	15:00	2.68	110.08
23-Jan-14	15:15	2.60	103.97
23-Jan-14	15:30	2.49	95.62
23-Jan-14	15:45	3.00	136.07
23-Jan-14	16:00	3.24	156.39
23-Jan-14	16:15	3.27	158.62
23-Jan-14	16:30	2.72	113.21
23-Jan-14	16:45	2.42	90.24
23-Jan-14	17:00	2.52	97.79
23-Jan-14	17:15	2.62	105.36
23-Jan-14	17:30	2.45	92.10
23-Jan-14	17:45	2.81	119.77
23-Jan-14	18:00	2.87	124.96
23-Jan-14	18:15	2.86	123.91
23-Jan-14	18:30	2.15	71.63
23-Jan-14	18:45	2.01	62.74
23-Jan-14	19:00	1.87	54.08
23-Jan-14	19:15	1.91	56.91
23-Jan-14	19:30	1.98	60.86
23-Jan-14	19:45	1.86	54.00
23-Jan-14	20:00	1.77	48.62
23-Jan-14	20:15	1.81	50.89
23-Jan-14	20:30	1.77	48.93
23-Jan-14	20:45	1.78	49.19
23-Jan-14	21:00	1.67	43.21
23-Jan-14	21:15	1.67	43.15
23-Jan-14	21:30	1.66	42.88

23-Jan-14	21:45	1.54	36.72
23-Jan-14	22:00	1.82	51.50
23-Jan-14	22:15	1.53	36.41
23-Jan-14	22:30	1.51	35.36
23-Jan-14	22:45	1.50	34.62
23-Jan-14	23:00	1.49	34.37
23-Jan-14	23:15	1.50	34.97
23-Jan-14	23:30	1.52	35.57
23-Jan-14	23:45	1.42	31.07
24-Jan-14	0:00	1.51	35.18
24-Jan-14	0:15	1.50	34.66
24-Jan-14	0:30	1.54	36.77
24-Jan-14	0:45	1.49	34.13
24-Jan-14	1:00	1.44	32.08
24-Jan-14	1:15	1.41	30.50
24-Jan-14	1:30	1.35	28.19
24-Jan-14	1:45	1.42	31.04
24-Jan-14	2:00	1.45	32.41
24-Jan-14	2:15	1.41	30.84
24-Jan-14	2:30	1.51	35.19
24-Jan-14	2:45	1.46	33.16
24-Jan-14	3:00	1.48	33.88
24-Jan-14	3:15	1.63	41.29
24-Jan-14	3:30	1.50	34.60
24-Jan-14	3:45	1.29	25.53
24-Jan-14	4:00	1.20	21.88
24-Jan-14	4:15	1.30	26.10
24-Jan-14	4:30	1.50	34.77
24-Jan-14	4:45	1.25	23.93
24-Jan-14	5:00	1.21	22.46
24-Jan-14	5:15	1.22	22.75
24-Jan-14	5:30	1.27	24.89
24-Jan-14	5:45	1.21	22.56
24-Jan-14	6:00	1.12	19.15

24-Jan-14	6:15	1.13	19.40
24-Jan-14	6:30	1.13	19.61
24-Jan-14	6:45	1.39	29.92
24-Jan-14	7:00	1.47	33.65
24-Jan-14	7:15	1.35	28.05
24-Jan-14	7:30	2.11	68.87
24-Jan-14	7:45	1.93	58.00
24-Jan-14	8:00	1.50	34.73
24-Jan-14	8:15	1.48	33.97
24-Jan-14	8:30	1.41	30.84
24-Jan-14	8:45	1.73	46.67
24-Jan-14	9:00	2.14	70.75
24-Jan-14	9:15	1.96	59.61
24-Jan-14	9:30	1.95	58.91
24-Jan-14	9:45	2.34	84.66
24-Jan-14	10:00	2.43	90.68
24-Jan-14	10:15	2.73	113.94
24-Jan-14	10:30	3.14	147.58
24-Jan-14	10:45	3.11	145.15
24-Jan-14	11:00	2.56	100.60
24-Jan-14	11:15	2.62	105.04
24-Jan-14	11:30	2.65	107.43
24-Jan-14	11:45	2.87	125.32
24-Jan-14	12:00	2.82	121.11
24-Jan-14	12:15	3.25	157.03
24-Jan-14	12:30	3.24	156.00
24-Jan-14	12:45	3.18	151.42
24-Jan-14	13:00	2.62	105.21
24-Jan-14	13:15	2.69	110.43
24-Jan-14	13:30	2.69	110.59
24-Jan-14	13:45	2.73	113.86
24-Jan-14	14:00	3.10	144.26
24-Jan-14	14:15	3.22	154.78
24-Jan-14	14:30	3.35	166.23

24-Jan-14	14:45	3.09	143.62
24-Jan-14	15:00	2.66	108.33
24-Jan-14	15:15	2.68	110.01
24-Jan-14	15:30	2.71	112.52
24-Jan-14	15:45	2.61	104.52
24-Jan-14	16:00	3.16	149.31
24-Jan-14	16:15	3.21	153.82
24-Jan-14	16:30	2.83	121.47
24-Jan-14	16:45	2.58	102.44
24-Jan-14	17:00	2.62	105.18
24-Jan-14	17:15	2.67	108.72
24-Jan-14	17:30	2.55	99.50
24-Jan-14	17:45	2.49	95.40
24-Jan-14	18:00	2.65	107.77
24-Jan-14	18:15	2.88	125.94
24-Jan-14	18:30	2.69	110.65
24-Jan-14	18:45	2.29	81.36
24-Jan-14	19:00	2.18	73.50
24-Jan-14	19:15	2.27	79.47
24-Jan-14	19:30	2.14	71.25
24-Jan-14	19:45	2.03	64.04
24-Jan-14	20:00	1.95	58.84
24-Jan-14	20:15	1.94	58.29
24-Jan-14	20:30	1.87	54.50
24-Jan-14	20:45	1.87	54.32
24-Jan-14	21:00	1.91	56.45
24-Jan-14	21:15	1.89	55.28
24-Jan-14	21:30	1.80	50.18
24-Jan-14	21:45	1.68	43.59
24-Jan-14	22:00	1.70	44.81
24-Jan-14	22:15	1.61	40.33
24-Jan-14	22:30	1.61	40.20
24-Jan-14	22:45	1.63	41.46
24-Jan-14	23:00	1.49	34.37

24-Jan-14	23:15	1:57	38.08
24-Jan-14	23:30	1:60	39.72
24-Jan-14	23:45	1:49	34.48
25-Jan-14	0:00	1:49	34.36
25-Jan-14	0:15	1:46	33.16
25-Jan-14	0:30	1:43	31.62
25-Jan-14	0:45	1:44	32.28
25-Jan-14	1:00	1:43	31.74
25-Jan-14	1:15	1:53	36.41
25-Jan-14	1:30	1:52	35.94
25-Jan-14	1:45	1:45	32.39
25-Jan-14	2:00	1:44	32.02
25-Jan-14	2:15	1:28	25.03
25-Jan-14	2:30	1:18	21.40
25-Jan-14	2:45	1:26	24.20
25-Jan-14	3:00	1:12	19.10
25-Jan-14	3:15	1:34	27.66
25-Jan-14	3:30	1:50	35.03
25-Jan-14	3:45	1:39	29.92
25-Jan-14	4:00	1:20	22.15
25-Jan-14	4:15	1:22	22.92
25-Jan-14	4:30	1:47	33.64
25-Jan-14	4:45	1:19	21.64
25-Jan-14	5:00	1:12	19.07
25-Jan-14	5:15	1:12	19.23
25-Jan-14	5:30	1:19	21.49
25-Jan-14	5:45	1:24	23.75
25-Jan-14	6:00	1:22	22.93
25-Jan-14	6:15	1:21	22.51
25-Jan-14	6:30	1:18	21.45
25-Jan-14	6:45	1:24	23.72
25-Jan-14	7:00	1:26	24.19
25-Jan-14	7:15	1:28	25.01
25-Jan-14	7:30	1:51	35.32

25-Jan-14	7:45	1.47	33.23
25-Jan-14	8:00	1.51	35.08
25-Jan-14	8:15	1.52	35.78
25-Jan-14	8:30	1.91	56.54
25-Jan-14	8:45	1.62	40.51
25-Jan-14	9:00	1.83	51.95
25-Jan-14	9:15	2.63	105.73
25-Jan-14	9:30	2.50	96.47
25-Jan-14	9:45	2.03	63.73
25-Jan-14	10:00	2.13	70.68
25-Jan-14	10:15	2.46	93.14
25-Jan-14	10:30	2.49	95.25
25-Jan-14	10:45	2.69	110.40
25-Jan-14	11:00	3.38	168.81
25-Jan-14	11:15	3.32	163.27
25-Jan-14	11:30	3.17	150.39
25-Jan-14	11:45	2.56	100.38
25-Jan-14	12:00	2.52	97.58
25-Jan-14	12:15	2.49	95.28
25-Jan-14	12:30	2.67	109.20
25-Jan-14	12:45	3.35	166.50
25-Jan-14	13:00	3.36	167.33
25-Jan-14	13:15	3.34	165.39
25-Jan-14	13:30	3.31	162.27
25-Jan-14	13:45	2.80	119.55
25-Jan-14	14:00	2.73	113.68
25-Jan-14	14:15	2.59	102.97
25-Jan-14	14:30	3.18	151.32
25-Jan-14	14:45	3.32	163.56
25-Jan-14	15:00	3.33	164.00
25-Jan-14	15:15	3.01	136.77
25-Jan-14	15:30	2.66	108.10
25-Jan-14	15:45	2.47	93.93
25-Jan-14	16:00	2.42	90.30

25-Jan-14	16:15	2.62	105.33
25-Jan-14	16:30	3.00	136.13
25-Jan-14	16:45	2.87	125.01
25-Jan-14	17:00	2.75	115.33
25-Jan-14	17:15	2.37	86.42
25-Jan-14	17:30	2.48	94.54
25-Jan-14	17:45	2.19	73.99
25-Jan-14	18:00	2.31	82.65
25-Jan-14	18:15	2.38	87.43
25-Jan-14	18:30	2.63	105.89
25-Jan-14	18:45	2.38	87.13
25-Jan-14	19:00	1.84	52.44
25-Jan-14	19:15	1.74	47.00
25-Jan-14	19:30	1.97	60.53
25-Jan-14	19:45	1.83	52.30
25-Jan-14	20:00	1.86	53.55
25-Jan-14	20:15	1.81	50.66
25-Jan-14	20:30	1.82	51.25
25-Jan-14	20:45	1.66	42.65
25-Jan-14	21:00	1.56	37.84
25-Jan-14	21:15	1.59	39.27
25-Jan-14	21:30	1.67	43.39
25-Jan-14	21:45	1.62	40.53
25-Jan-14	22:00	1.64	41.84
25-Jan-14	22:15	1.51	35.15
25-Jan-14	22:30	1.62	40.66
25-Jan-14	22:45	1.54	36.60
25-Jan-14	23:00	1.37	28.88
25-Jan-14	23:15	1.22	22.91
25-Jan-14	23:30	1.25	23.98
25-Jan-14	23:45	1.27	24.60
26-Jan-14	0:00	1.32	26.94
26-Jan-14	0:15	1.08	17.57
26-Jan-14	0:30	1.21	22.33

26-Jan-14	0:45	1:21	22.51
26-Jan-14	1:00	1:20	22.19
26-Jan-14	1:15	1:21	22.38
26-Jan-14	1:30	1:37	28.85
26-Jan-14	1:45	1:27	24.67
26-Jan-14	2:00	1:34	27.67
26-Jan-14	2:15	1:17	21.10
26-Jan-14	2:30	1:10	18.55
26-Jan-14	2:45	1:18	21.42
26-Jan-14	3:00	1:17	20.86
26-Jan-14	3:15	1:37	29.00
26-Jan-14	3:30	1:34	27.78
26-Jan-14	3:45	1:16	20.70
26-Jan-14	4:00	1:12	19.12
26-Jan-14	4:15	1:18	21.38
26-Jan-14	4:30	1:20	22.03
26-Jan-14	4:45	1:09	18.22
26-Jan-14	5:00	1:00	15.15
26-Jan-14	5:15	0:97	14.03
26-Jan-14	5:30	0:97	14.09
26-Jan-14	5:45	1:09	18.08
26-Jan-14	6:00	1:00	15.04
26-Jan-14	6:15	0:96	13.73
26-Jan-14	6:30	0:95	13.69
26-Jan-14	6:45	0:97	14.16
26-Jan-14	7:00	1:05	16.59
26-Jan-14	7:15	0:99	14.81
26-Jan-14	7:30	1:13	19.32
26-Jan-14	7:45	1:47	33.49
26-Jan-14	8:00	1:16	20.61
26-Jan-14	8:15	1:07	17.29
26-Jan-14	8:30	1:40	30.46
26-Jan-14	8:45	1:89	55.80
26-Jan-14	9:00	1:83	52.23

26-Jan-14	9:15	1.65	42.35
26-Jan-14	9:30	1.65	42.32
26-Jan-14	9:45	1.50	34.95
26-Jan-14	10:00	2.03	63.88
26-Jan-14	10:15	1.93	58.17
26-Jan-14	10:30	1.84	52.48
26-Jan-14	10:45	1.88	54.74
26-Jan-14	11:00	1.99	61.55
26-Jan-14	11:15	2.67	108.81
26-Jan-14	11:30	2.67	109.19
26-Jan-14	11:45	2.88	125.81
26-Jan-14	12:00	2.72	112.91
26-Jan-14	12:15	2.30	81.97
26-Jan-14	12:30	2.40	88.54
26-Jan-14	12:45	2.21	75.86
26-Jan-14	13:00	2.75	115.26
26-Jan-14	13:15	2.60	103.97
26-Jan-14	13:30	2.84	122.54
26-Jan-14	13:45	2.91	128.46
26-Jan-14	14:00	2.77	117.00
26-Jan-14	14:15	2.57	101.03
26-Jan-14	14:30	2.45	92.76
26-Jan-14	14:45	2.45	92.13
26-Jan-14	15:00	2.77	116.49
26-Jan-14	15:15	2.87	124.65
26-Jan-14	15:30	2.88	126.08
26-Jan-14	15:45	2.87	124.67
26-Jan-14	16:00	2.76	116.42
26-Jan-14	16:15	2.57	101.51
26-Jan-14	16:30	2.29	81.12
26-Jan-14	16:45	2.38	87.58
26-Jan-14	17:00	2.60	103.99
26-Jan-14	17:15	2.69	110.58
26-Jan-14	17:30	3.05	140.03

26-Jan-14	17:45	2.66	108.13
26-Jan-14	18:00	2.26	79.05
26-Jan-14	18:15	2.04	64.59
26-Jan-14	18:30	1.94	58.59
26-Jan-14	18:45	1.82	51.22
26-Jan-14	19:00	1.82	51.51
26-Jan-14	19:15	1.82	51.47
26-Jan-14	19:30	1.77	48.75
26-Jan-14	19:45	1.69	44.36
26-Jan-14	20:00	1.62	40.92
26-Jan-14	20:15	1.66	42.92
26-Jan-14	20:30	1.52	35.86
26-Jan-14	20:45	1.49	34.15
26-Jan-14	21:00	1.51	35.09
26-Jan-14	21:15	1.59	39.07
26-Jan-14	21:30	1.54	36.82
26-Jan-14	21:45	1.44	32.25
26-Jan-14	22:00	1.27	24.92
26-Jan-14	22:15	1.30	26.06
26-Jan-14	22:30	1.26	24.50
26-Jan-14	22:45	1.29	25.50
26-Jan-14	23:00	1.14	19.87
26-Jan-14	23:15	1.09	18.10
26-Jan-14	23:30	1.13	19.51
26-Jan-14	23:45	1.25	23.92
27-Jan-14	0:00	1.02	15.82
27-Jan-14	0:15	1.13	19.31
27-Jan-14	0:30	1.13	19.60
27-Jan-14	0:45	1.08	17.67
27-Jan-14	1:00	1.15	20.02
27-Jan-14	1:15	1.10	18.24
27-Jan-14	1:30	1.17	20.80
27-Jan-14	1:45	1.11	18.69
27-Jan-14	2:00	1.07	17.37

27-Jan-14	2:15	1.03	16.03
27-Jan-14	2:30	1.39	29.79
27-Jan-14	2:45	1.91	56.54
27-Jan-14	3:00	1.64	41.72
27-Jan-14	3:15	1.16	20.65
27-Jan-14	3:30	1.22	22.83
27-Jan-14	3:45	1.15	20.10
27-Jan-14	4:00	1.07	17.52
27-Jan-14	4:15	1.12	19.27
27-Jan-14	4:30	1.22	22.91
27-Jan-14	4:45	1.10	18.40
27-Jan-14	5:00	1.09	18.04
27-Jan-14	5:15	1.04	16.23
27-Jan-14	5:30	1.03	16.00
27-Jan-14	5:45	1.08	17.83
27-Jan-14	6:00	1.06	16.98
27-Jan-14	6:15	1.17	20.79
27-Jan-14	6:30	1.18	21.31
27-Jan-14	6:45	1.15	20.34
27-Jan-14	7:00	1.18	21.14
27-Jan-14	7:15	1.07	17.49
27-Jan-14	7:30	1.20	22.13
27-Jan-14	7:45	1.47	33.56
27-Jan-14	8:00	1.95	59.17
27-Jan-14	8:15	2.10	68.70
27-Jan-14	8:30	1.70	44.85
27-Jan-14	8:45	1.56	37.80
27-Jan-14	9:00	1.81	51.14
27-Jan-14	9:15	1.93	57.67
27-Jan-14	9:30	1.89	55.33
27-Jan-14	9:45	1.85	53.24
27-Jan-14	10:00	2.03	63.82
27-Jan-14	10:15	2.07	66.52
27-Jan-14	10:30	2.53	98.67

27-Jan-14	10:45	2.43	91.04
27-Jan-14	11:00	2.49	95.34
27-Jan-14	11:15	2.85	123.39
27-Jan-14	11:30	2.89	126.61
27-Jan-14	11:45	2.59	102.55
27-Jan-14	12:00	2.55	99.60
27-Jan-14	12:15	2.61	104.45
27-Jan-14	12:30	2.48	94.54
27-Jan-14	12:45	2.77	116.73
27-Jan-14	13:00	3.17	150.54
27-Jan-14	13:15	3.11	145.23
27-Jan-14	13:30	2.96	132.52
27-Jan-14	13:45	2.58	101.85
27-Jan-14	14:00	2.55	99.96
27-Jan-14	14:15	2.62	105.44
27-Jan-14	14:30	2.51	96.97
27-Jan-14	14:45	2.82	121.08
27-Jan-14	15:00	3.23	155.09
27-Jan-14	15:15	3.09	143.32
27-Jan-14	15:30	2.61	104.11
27-Jan-14	15:45	2.56	100.69
27-Jan-14	16:00	2.53	98.17
27-Jan-14	16:15	2.55	99.87
27-Jan-14	16:30	2.44	91.72
27-Jan-14	16:45	2.72	112.53
27-Jan-14	17:00	2.86	124.25
27-Jan-14	17:15	2.77	116.75
27-Jan-14	17:30	2.44	91.88
27-Jan-14	17:45	2.50	96.45
27-Jan-14	18:00	2.27	79.83
27-Jan-14	18:15	2.32	83.34
27-Jan-14	18:30	2.37	86.48
27-Jan-14	18:45	2.01	62.96
27-Jan-14	19:00	1.82	51.33

27-Jan-14	19:15	2.36	85.89
27-Jan-14	19:30	2.58	102.29
27-Jan-14	19:45	2.08	67.23
27-Jan-14	20:00	1.74	46.80
27-Jan-14	20:15	1.71	45.28
27-Jan-14	20:30	1.63	41.21
27-Jan-14	20:45	1.63	41.41
27-Jan-14	21:00	1.52	35.87
27-Jan-14	21:15	1.70	44.87
27-Jan-14	21:30	1.69	44.26
27-Jan-14	21:45	1.67	43.38
27-Jan-14	22:00	1.51	35.31
27-Jan-14	22:15	1.40	30.35
27-Jan-14	22:30	1.44	31.84
27-Jan-14	22:45	1.34	27.56
27-Jan-14	23:00	1.28	24.98
27-Jan-14	23:15	1.44	31.86
27-Jan-14	23:30	1.44	31.90
27-Jan-14	23:45	1.35	27.94
28-Jan-14	0:00	1.38	29.38
28-Jan-14	0:15	1.24	23.76
28-Jan-14	0:30	1.41	30.51
28-Jan-14	0:45	1.22	22.80
28-Jan-14	1:00	1.17	20.76
28-Jan-14	1:15	1.11	18.72
28-Jan-14	1:30	1.16	20.69
28-Jan-14	1:45	1.13	19.39
28-Jan-14	2:00	1.16	20.47
28-Jan-14	2:15	1.20	21.95
28-Jan-14	2:30	1.17	21.05
28-Jan-14	2:45	1.15	20.18
28-Jan-14	3:00	1.13	19.44
28-Jan-14	3:15	1.49	34.14
28-Jan-14	3:30	1.32	26.84

28-Jan-14	3:45	1.19	21.67
28-Jan-14	4:00	1.08	17.84
28-Jan-14	4:15	1.08	17.62
28-Jan-14	4:30	1.25	23.79
28-Jan-14	4:45	1.14	19.70
28-Jan-14	5:00	1.01	15.48
28-Jan-14	5:15	1.00	15.00
28-Jan-14	5:30	1.00	15.10
28-Jan-14	5:45	1.14	19.98
28-Jan-14	6:00	1.07	17.23
28-Jan-14	6:15	1.05	16.81
28-Jan-14	6:30	1.14	19.93
28-Jan-14	6:45	1.16	20.55
28-Jan-14	7:00	1.12	19.08
28-Jan-14	7:15	1.16	20.50
28-Jan-14	7:30	1.19	21.61
28-Jan-14	7:45	1.48	34.11
28-Jan-14	8:00	1.20	22.08
28-Jan-14	8:15	1.44	32.09
28-Jan-14	8:30	1.63	41.20
28-Jan-14	8:45	1.55	37.35
28-Jan-14	9:00	1.88	54.92
28-Jan-14	9:15	2.15	71.64
28-Jan-14	9:30	2.51	96.68
28-Jan-14	9:45	2.25	78.33
28-Jan-14	10:00	2.75	115.50
28-Jan-14	10:15	2.93	130.15
28-Jan-14	10:30	2.68	110.14
28-Jan-14	10:45	2.27	79.42
28-Jan-14	11:00	2.48	94.86
28-Jan-14	11:15	2.48	94.93
28-Jan-14	11:30	2.63	105.97
28-Jan-14	11:45	2.63	106.29
28-Jan-14	12:00	3.02	137.30

28-Jan-14	12:15	3.08	142.68
28-Jan-14	12:30	3.19	151.84
28-Jan-14	12:45	2.96	132.48
28-Jan-14	13:00	2.70	111.31
28-Jan-14	13:15	2.58	102.17
28-Jan-14	13:30	2.96	132.62
28-Jan-14	13:45	3.29	160.48
28-Jan-14	14:00	3.28	160.15
28-Jan-14	14:15	2.90	127.69
28-Jan-14	14:30	2.54	99.34
28-Jan-14	14:45	2.56	100.80
28-Jan-14	15:00	2.68	109.79
28-Jan-14	15:15	2.71	112.03
28-Jan-14	15:30	3.20	152.48
28-Jan-14	15:45	3.27	158.63
28-Jan-14	16:00	3.05	140.33
28-Jan-14	16:15	2.49	95.54
28-Jan-14	16:30	2.52	97.88
28-Jan-14	16:45	2.35	85.09
28-Jan-14	17:00	2.16	72.32
28-Jan-14	17:15	2.60	103.45
28-Jan-14	17:30	3.21	153.76
28-Jan-14	17:45	3.04	138.89
28-Jan-14	18:00	2.65	107.53
28-Jan-14	18:15	2.18	73.95
28-Jan-14	18:30	2.05	65.47
28-Jan-14	18:45	1.94	58.50
28-Jan-14	19:00	1.99	61.58
28-Jan-14	19:15	1.88	55.11
28-Jan-14	19:30	2.04	64.62
28-Jan-14	19:45	1.82	51.30
28-Jan-14	20:00	1.87	54.47
28-Jan-14	20:15	1.85	53.14
28-Jan-14	20:30	1.84	52.75

28-Jan-14	20:45	1.84	52.76
28-Jan-14	21:00	1.78	49.22
28-Jan-14	21:15	1.73	46.59
28-Jan-14	21:30	1.80	50.40
28-Jan-14	21:45	1.68	43.75
28-Jan-14	22:00	1.70	44.72
28-Jan-14	22:15	1.62	40.74
28-Jan-14	22:30	1.65	42.02
28-Jan-14	22:45	1.57	38.18
28-Jan-14	23:00	1.61	40.44
28-Jan-14	23:15	1.47	33.41
28-Jan-14	23:30	1.50	34.86
28-Jan-14	23:45	1.50	34.85
29-Jan-14	0:00	1.43	31.54
29-Jan-14	0:15	1.51	35.35
29-Jan-14	0:30	1.98	60.93
29-Jan-14	0:45	2.12	69.81
29-Jan-14	1:00	1.72	46.00
29-Jan-14	1:15	1.49	34.52
29-Jan-14	1:30	1.57	38.11
29-Jan-14	1:45	1.50	34.82
29-Jan-14	2:00	1.43	31.75
29-Jan-14	2:15	1.24	23.67
29-Jan-14	2:30	1.22	22.93
29-Jan-14	2:45	1.25	23.83
29-Jan-14	3:00	1.27	24.59
29-Jan-14	3:15	1.32	27.02
29-Jan-14	3:30	1.47	33.26
29-Jan-14	3:45	1.46	33.15
29-Jan-14	4:00	1.48	33.90
29-Jan-14	4:15	1.52	35.56
29-Jan-14	4:30	1.45	32.60
29-Jan-14	4:45	1.40	30.22
29-Jan-14	5:00	1.11	18.74

29-Jan-14	5:15	1.21	22.34
29-Jan-14	5:30	1.48	33.85
29-Jan-14	5:45	1.47	33.65
29-Jan-14	6:00	1.27	24.86
29-Jan-14	6:15	1.18	21.11
29-Jan-14	6:30	1.16	20.52
29-Jan-14	6:45	1.49	34.60
29-Jan-14	7:00	1.44	32.23
29-Jan-14	7:15	1.34	27.60
29-Jan-14	7:30	1.46	32.88
29-Jan-14	7:45	1.48	33.74
29-Jan-14	8:00	1.50	34.74
29-Jan-14	8:15	1.36	28.45
29-Jan-14	8:30	1.63	41.14
29-Jan-14	8:45	1.78	49.32
29-Jan-14	9:00	1.84	52.83
29-Jan-14	9:15	2.01	62.73
29-Jan-14	9:30	2.35	84.99
29-Jan-14	9:45	2.53	98.32
29-Jan-14	10:00	3.30	161.88
29-Jan-14	10:15	3.38	168.84
29-Jan-14	10:30	2.67	108.68
29-Jan-14	10:45	2.50	96.26
29-Jan-14	11:00	2.59	102.93
29-Jan-14	11:15	2.60	103.75
29-Jan-14	11:30	2.80	119.61
29-Jan-14	11:45	3.21	153.91
29-Jan-14	12:00	3.38	169.08
29-Jan-14	12:15	3.38	168.84
29-Jan-14	12:30	3.00	135.93
29-Jan-14	12:45	2.54	98.74
29-Jan-14	13:00	2.60	103.70
29-Jan-14	13:15	2.65	107.36
29-Jan-14	13:30	3.14	147.82

29-Jan-14	13:45	3.28	160.35
29-Jan-14	14:00	3.25	157.55
29-Jan-14	14:15	3.06	140.52
29-Jan-14	14:30	2.52	97.74
29-Jan-14	14:45	2.68	109.77
29-Jan-14	15:00	2.88	125.91
29-Jan-14	15:15	2.87	124.88
29-Jan-14	15:30	3.27	158.86
29-Jan-14	15:45	3.35	166.49
29-Jan-14	16:00	2.90	127.15
29-Jan-14	16:15	2.47	93.77
29-Jan-14	16:30	2.48	94.64
29-Jan-14	16:45	2.36	85.80
29-Jan-14	17:00	2.50	96.03
29-Jan-14	17:15	2.67	109.23
29-Jan-14	17:30	3.08	142.84
29-Jan-14	17:45	2.86	124.11
29-Jan-14	18:00	2.58	102.04
29-Jan-14	18:15	2.52	97.88
29-Jan-14	18:30	2.50	96.11
29-Jan-14	18:45	2.31	82.49
29-Jan-14	19:00	2.29	80.93
29-Jan-14	19:15	1.99	61.64
29-Jan-14	19:30	1.97	60.08
29-Jan-14	19:45	1.80	50.31
29-Jan-14	20:00	1.91	56.87
29-Jan-14	20:15	1.90	56.38
29-Jan-14	20:30	1.86	54.01
29-Jan-14	20:45	1.84	52.39
29-Jan-14	21:00	1.70	45.08
29-Jan-14	21:15	1.87	54.36
29-Jan-14	21:30	1.85	53.06
29-Jan-14	21:45	1.68	43.70
29-Jan-14	22:00	1.68	43.92

29-Jan-14	22:15	1.66	42.55
29-Jan-14	22:30	1.64	41.61
29-Jan-14	22:45	1.65	42.16
29-Jan-14	23:00	1.55	37.04
29-Jan-14	23:15	1.40	30.28
29-Jan-14	23:30	1.47	33.42
29-Jan-14	23:45	1.44	32.06
30-Jan-14	0:00	1.30	25.87
30-Jan-14	0:15	1.46	32.74
30-Jan-14	0:30	1.26	24.24
30-Jan-14	0:45	1.36	28.64
30-Jan-14	1:00	1.34	27.53
30-Jan-14	1:15	1.30	25.93
30-Jan-14	1:30	1.29	25.63
30-Jan-14	1:45	1.25	24.07
30-Jan-14	2:00	1.31	26.58
30-Jan-14	2:15	1.36	28.66
30-Jan-14	2:30	1.44	31.87
30-Jan-14	2:45	1.38	29.42
30-Jan-14	3:00	1.21	22.59
30-Jan-14	3:15	1.80	50.37
30-Jan-14	3:30	2.07	66.24
30-Jan-14	3:45	1.81	51.09
30-Jan-14	4:00	1.29	25.67
30-Jan-14	4:15	1.28	25.13
30-Jan-14	4:30	1.45	32.39
30-Jan-14	4:45	1.30	25.98
30-Jan-14	5:00	1.17	20.79
30-Jan-14	5:15	1.16	20.67
30-Jan-14	5:30	1.23	23.29
30-Jan-14	5:45	1.30	26.11
30-Jan-14	6:00	1.19	21.75
30-Jan-14	6:15	1.23	23.02
30-Jan-14	6:30	1.26	24.55

30-Jan-14	6:45	1.35	28.14
30-Jan-14	7:00	1.22	22.96
30-Jan-14	7:15	1.27	24.84
30-Jan-14	7:30	1.64	41.50
30-Jan-14	7:45	1.53	36.45
30-Jan-14	8:00	1.31	26.57
30-Jan-14	8:15	1.43	31.68
30-Jan-14	8:30	1.49	34.19
30-Jan-14	8:45	1.64	41.65
30-Jan-14	9:00	1.91	56.91
30-Jan-14	9:15	2.07	66.44
30-Jan-14	9:30	2.11	68.81
30-Jan-14	9:45	2.18	73.92
30-Jan-14	10:00	2.42	90.29
30-Jan-14	10:15	2.57	101.22
30-Jan-14	10:30	2.57	101.60
30-Jan-14	10:45	2.39	87.86
30-Jan-14	11:00	2.37	86.52
30-Jan-14	11:15	2.77	116.57
30-Jan-14	11:30	2.54	99.00
30-Jan-14	11:45	2.50	96.31
30-Jan-14	12:00	3.14	147.60
30-Jan-14	12:15	3.04	139.19
30-Jan-14	12:30	3.28	160.01
30-Jan-14	12:45	3.09	143.24
30-Jan-14	13:00	2.61	104.71
30-Jan-14	13:15	2.70	111.27
30-Jan-14	13:30	2.76	115.77
30-Jan-14	13:45	2.68	109.89
30-Jan-14	14:00	3.23	155.14
30-Jan-14	14:15	3.31	162.38
30-Jan-14	14:30	3.30	161.83
30-Jan-14	14:45	2.80	119.57
30-Jan-14	15:00	2.43	91.26

30-Jan-14	15:15	2.67	108.75
30-Jan-14	15:30	2.84	122.28
30-Jan-14	15:45	3.19	152.07
30-Jan-14	16:00	3.12	146.00
30-Jan-14	16:15	3.23	155.87
30-Jan-14	16:30	2.66	108.43
30-Jan-14	16:45	2.14	71.22
30-Jan-14	17:00	2.47	94.24
30-Jan-14	17:15	2.43	90.73
30-Jan-14	17:30	2.37	86.48
30-Jan-14	17:45	2.60	103.55
30-Jan-14	18:00	2.97	132.89
30-Jan-14	18:15	2.80	119.02
30-Jan-14	18:30	2.49	95.07
30-Jan-14	18:45	2.17	72.69
30-Jan-14	19:00	2.10	68.42
30-Jan-14	19:15	2.01	62.59
30-Jan-14	19:30	2.02	63.39
30-Jan-14	19:45	2.06	66.12
30-Jan-14	20:00	1.97	60.44
30-Jan-14	20:15	1.88	54.77
30-Jan-14	20:30	1.80	50.23
30-Jan-14	20:45	1.75	47.59
30-Jan-14	21:00	1.69	44.61
30-Jan-14	21:15	1.74	46.78
30-Jan-14	21:30	1.83	52.09
30-Jan-14	21:45	1.72	46.21
30-Jan-14	22:00	1.40	30.48
30-Jan-14	22:15	1.54	36.96
30-Jan-14	22:30	1.51	35.48
30-Jan-14	22:45	1.55	37.37
30-Jan-14	23:00	1.51	35.09
30-Jan-14	23:15	1.51	35.52
30-Jan-14	23:30	1.50	34.83

30-Jan-14	23:45	1.53	36.23
31-Jan-14	0:00	1.50	34.71
31-Jan-14	0:15	1.55	37.30
31-Jan-14	0:30	1.44	32.27
31-Jan-14	0:45	1.43	31.82
31-Jan-14	1:00	1.47	33.53
31-Jan-14	1:15	1.45	32.41
31-Jan-14	1:30	1.42	30.96
31-Jan-14	1:45	1.34	27.76
31-Jan-14	2:00	1.46	32.89
31-Jan-14	2:15	1.24	23.53
31-Jan-14	2:30	1.28	25.27
31-Jan-14	2:45	1.35	28.16
31-Jan-14	3:00	1.18	21.26
31-Jan-14	3:15	1.40	30.05
31-Jan-14	3:30	1.50	34.64
31-Jan-14	3:45	1.29	25.61
31-Jan-14	4:00	1.23	23.25
31-Jan-14	4:15	1.12	18.94
31-Jan-14	4:30	1.43	31.82
31-Jan-14	4:45	1.21	22.57
31-Jan-14	5:00	1.12	19.09
31-Jan-14	5:15	1.14	19.65
31-Jan-14	5:30	1.12	19.27
31-Jan-14	5:45	1.25	24.06
31-Jan-14	6:00	1.12	19.09
31-Jan-14	6:15	1.13	19.64
31-Jan-14	6:30	1.12	19.27
31-Jan-14	6:45	1.32	26.77
31-Jan-14	7:00	1.35	28.13
31-Jan-14	7:15	1.38	29.31
31-Jan-14	7:30	1.53	36.04
31-Jan-14	7:45	1.55	37.03
31-Jan-14	8:00	1.52	35.59

31-Jan-14	8:15	1:51	35.44
31-Jan-14	8:30	1.74	46.82
31-Jan-14	8:45	2.04	64.89
31-Jan-14	9:00	2.39	88.42
31-Jan-14	9:15	2.74	114.58
31-Jan-14	9:30	2.56	100.29
31-Jan-14	9:45	2.25	78.31
31-Jan-14	10:00	2.30	81.92
31-Jan-14	10:15	2.28	80.40
31-Jan-14	10:30	2.61	104.25
31-Jan-14	10:45	2.49	95.36
31-Jan-14	11:00	2.70	111.53
31-Jan-14	11:15	3.30	161.61
31-Jan-14	11:30	3.42	172.46
31-Jan-14	11:45	3.45	175.51
31-Jan-14	12:00	2.84	122.79
31-Jan-14	12:15	2.89	126.63
31-Jan-14	12:30	2.84	122.52
31-Jan-14	12:45	2.75	114.95
31-Jan-14	13:00	2.60	103.89
31-Jan-14	13:15	2.67	108.98
31-Jan-14	13:30	3.23	155.64
31-Jan-14	13:45	3.25	157.05
31-Jan-14	14:00	3.29	160.86
31-Jan-14	14:15	3.07	141.60
31-Jan-14	14:30	2.80	119.12
31-Jan-14	14:45	2.92	129.29
31-Jan-14	15:00	2.56	100.96
31-Jan-14	15:15	2.66	108.55
31-Jan-14	15:30	2.71	111.99
31-Jan-14	15:45	2.42	90.52
31-Jan-14	16:00	3.16	149.06
31-Jan-14	16:15	3.13	147.00
31-Jan-14	16:30	3.00	135.86

31-Jan-14	16:45	2.50	96.32
31-Jan-14	17:00	2.53	98.52
31-Jan-14	17:15	2.53	98.66
31-Jan-14	17:30	2.76	115.99
31-Jan-14	17:45	2.77	117.27
31-Jan-14	18:00	3.08	142.21
31-Jan-14	18:15	3.11	145.03
31-Jan-14	18:30	2.93	130.01
31-Jan-14	18:45	2.25	78.45
31-Jan-14	19:00	2.13	70.49
31-Jan-14	19:15	2.09	67.86
31-Jan-14	19:30	2.14	70.73
31-Jan-14	19:45	2.05	65.50
31-Jan-14	20:00	2.04	64.67
31-Jan-14	20:15	2.00	62.24
31-Jan-14	20:30	1.97	60.22
31-Jan-14	20:45	1.93	58.01
31-Jan-14	21:00	1.80	50.08
31-Jan-14	21:15	1.83	52.02
31-Jan-14	21:30	1.83	51.85
31-Jan-14	21:45	1.82	51.45
31-Jan-14	22:00	1.80	50.31
31-Jan-14	22:15	1.84	52.55
31-Jan-14	22:30	1.76	48.16
31-Jan-14	22:45	1.69	44.54
31-Jan-14	23:00	1.68	44.03
31-Jan-14	23:15	1.56	37.60
31-Jan-14	23:30	1.68	44.02
31-Jan-14	23:45	1.63	41.09
1-Feb-14	0:00	1.56	37.84
1-Feb-14	0:15	1.54	36.79
1-Feb-14	0:30	1.52	35.89
1-Feb-14	0:45	1.49	34.29
1-Feb-14	1:00	1.51	35.46

1-Feb-14	1:15	1:52	35.81
1-Feb-14	1:30	1:59	39.33
1-Feb-14	1:45	1:49	34.31
1-Feb-14	2:00	1:70	44.82
1-Feb-14	2:15	1:58	38.95
1-Feb-14	2:30	1:44	31.99
1-Feb-14	2:45	1:47	33.30
1-Feb-14	3:00	1:53	36.21
1-Feb-14	3:15	1:73	46.77
1-Feb-14	3:30	1:57	38.21
1-Feb-14	3:45	1:34	27.55
1-Feb-14	4:00	1:21	22.55
1-Feb-14	4:15	1:27	24.64
1-Feb-14	4:30	1:46	33.04
1-Feb-14	4:45	1:19	21.66
1-Feb-14	5:00	1:08	17.79
1-Feb-14	5:15	1:06	17.07
1-Feb-14	5:30	1:10	18.43
1-Feb-14	5:45	1:31	26.22
1-Feb-14	6:00	1:10	18.41
1-Feb-14	6:15	1:13	19.41
1-Feb-14	6:30	1:24	23.42
1-Feb-14	6:45	1:28	25.21
1-Feb-14	7:00	1:22	22.68
1-Feb-14	7:15	1:37	29.15
1-Feb-14	7:30	1:40	30.15
1-Feb-14	7:45	1:48	33.92
1-Feb-14	8:00	1:46	32.97
1-Feb-14	8:15	1:49	34.39
1-Feb-14	8:30	1:54	36.66
1-Feb-14	8:45	1:50	34.98
1-Feb-14	9:00	1:51	35.54
1-Feb-14	9:15	1:74	47.23
1-Feb-14	9:30	2:64	106.39

1-Feb-14	9:45	2.96	132.09
1-Feb-14	10:00	2.52	97.82
1-Feb-14	10:15	2.26	78.70
1-Feb-14	10:30	2.06	66.16
1-Feb-14	10:45	2.40	88.76
1-Feb-14	11:00	2.56	100.54
1-Feb-14	11:15	3.15	148.59
1-Feb-14	11:30	3.30	161.45
1-Feb-14	11:45	3.04	139.46
1-Feb-14	12:00	2.76	116.45
1-Feb-14	12:15	2.57	101.67
1-Feb-14	12:30	2.47	93.61
1-Feb-14	12:45	2.53	98.14
1-Feb-14	13:00	2.97	133.06
1-Feb-14	13:15	3.40	170.90
1-Feb-14	13:30	3.39	169.77
1-Feb-14	13:45	3.27	158.65
1-Feb-14	14:00	3.01	136.23
1-Feb-14	14:15	2.92	129.19
1-Feb-14	14:30	2.68	109.78
1-Feb-14	14:45	2.91	128.44
1-Feb-14	15:00	3.41	171.69
1-Feb-14	15:15	3.49	178.75
1-Feb-14	15:30	3.44	174.35
1-Feb-14	15:45	3.39	169.37
1-Feb-14	16:00	2.69	110.40
1-Feb-14	16:15	2.56	100.47
1-Feb-14	16:30	2.38	87.30
1-Feb-14	16:45	2.54	98.85
1-Feb-14	17:00	2.62	104.82
1-Feb-14	17:15	2.84	122.15
1-Feb-14	17:30	3.01	136.35
1-Feb-14	17:45	2.43	91.08
1-Feb-14	18:00	2.18	73.83

1-Feb-14	18:15	2.39	87.88
1-Feb-14	18:30	2.28	80.20
1-Feb-14	18:45	2.22	76.60
1-Feb-14	19:00	2.02	63.43
1-Feb-14	19:15	1.97	60.60
1-Feb-14	19:30	2.19	74.03
1-Feb-14	19:45	2.46	93.24
1-Feb-14	20:00	2.45	92.76
1-Feb-14	20:15	1.89	55.34
1-Feb-14	20:30	1.82	51.22
1-Feb-14	20:45	1.75	47.76
1-Feb-14	21:00	1.78	49.21
1-Feb-14	21:15	1.80	50.60
1-Feb-14	21:30	1.80	50.28
1-Feb-14	21:45	1.74	47.22
1-Feb-14	22:00	1.75	47.78
1-Feb-14	22:15	1.78	49.40
1-Feb-14	22:30	1.65	42.04
1-Feb-14	22:45	1.58	38.82
1-Feb-14	23:00	1.62	40.80
1-Feb-14	23:15	1.59	39.39
1-Feb-14	23:30	1.67	43.32
1-Feb-14	23:45	1.62	40.54
2-Feb-14	0:00	1.50	35.02
2-Feb-14	0:15	1.46	33.08
2-Feb-14	0:30	1.51	35.39
2-Feb-14	0:45	1.54	36.69
2-Feb-14	1:00	1.55	37.05
2-Feb-14	1:15	1.52	35.74
2-Feb-14	1:30	1.63	41.28
2-Feb-14	1:45	1.48	33.84
2-Feb-14	2:00	1.47	33.44
2-Feb-14	2:15	1.52	35.90
2-Feb-14	2:30	1.31	26.43

2-Feb-14	2:45	1.37	28.85
2-Feb-14	3:00	1.21	22.48
2-Feb-14	3:15	1.50	34.88
2-Feb-14	3:30	1.53	36.17
2-Feb-14	3:45	1.35	28.20
2-Feb-14	4:00	1.25	24.01
2-Feb-14	4:15	1.21	22.41
2-Feb-14	4:30	1.46	32.99
2-Feb-14	4:45	1.32	26.71
2-Feb-14	5:00	1.12	19.22
2-Feb-14	5:15	1.11	18.74
2-Feb-14	5:30	1.11	18.68
2-Feb-14	5:45	1.18	21.41
2-Feb-14	6:00	1.15	20.36
2-Feb-14	6:15	1.16	20.61
2-Feb-14	6:30	1.22	22.78
2-Feb-14	6:45	1.40	30.31
2-Feb-14	7:00	1.24	23.53
2-Feb-14	7:15	1.25	24.00
2-Feb-14	7:30	1.31	26.21
2-Feb-14	7:45	1.47	33.55
2-Feb-14	8:00	1.30	25.89
2-Feb-14	8:15	1.34	27.45
2-Feb-14	8:30	1.52	35.60
2-Feb-14	8:45	1.54	36.98
2-Feb-14	9:00	1.79	50.05
2-Feb-14	9:15	2.33	84.15
2-Feb-14	9:30	2.27	79.94
2-Feb-14	9:45	1.88	54.68
2-Feb-14	10:00	1.81	50.84
2-Feb-14	10:15	1.75	47.66
2-Feb-14	10:30	1.77	48.71
2-Feb-14	10:45	1.98	61.16
2-Feb-14	11:00	1.99	61.69

2-Feb-14	11:15	2.52	97.66
2-Feb-14	11:30	2.70	111.58
2-Feb-14	11:45	2.84	122.90
2-Feb-14	12:00	2.54	99.34
2-Feb-14	12:15	2.36	85.93
2-Feb-14	12:30	2.25	78.09
2-Feb-14	12:45	2.16	72.12
2-Feb-14	13:00	2.58	101.85
2-Feb-14	13:15	2.68	109.58
2-Feb-14	13:30	2.88	125.47
2-Feb-14	13:45	2.95	131.29
2-Feb-14	14:00	2.39	88.27
2-Feb-14	14:15	2.21	75.35
2-Feb-14	14:30	2.35	85.59
2-Feb-14	14:45	2.86	124.16
2-Feb-14	15:00	2.95	131.91
2-Feb-14	15:15	2.67	109.28
2-Feb-14	15:30	2.49	95.53
2-Feb-14	15:45	2.00	62.15
2-Feb-14	16:00	2.00	61.92
2-Feb-14	16:15	1.98	60.77
2-Feb-14	16:30	1.95	59.11
2-Feb-14	16:45	1.90	56.30
2-Feb-14	17:00	2.39	87.87
2-Feb-14	17:15	2.55	100.03
2-Feb-14	17:30	2.23	77.08
2-Feb-14	17:45	1.80	50.09
2-Feb-14	18:00	1.77	48.89
2-Feb-14	18:15	1.84	52.89
2-Feb-14	18:30	1.92	57.17
2-Feb-14	18:45	1.94	58.24
2-Feb-14	19:00	1.78	49.17
2-Feb-14	19:15	1.80	50.27
2-Feb-14	19:30	1.90	56.17

2-Feb-14	19:45	1.81	51.06
2-Feb-14	20:00	1.84	52.51
2-Feb-14	20:15	1.77	48.54
2-Feb-14	20:30	2.05	65.23
2-Feb-14	20:45	2.27	79.45
2-Feb-14	21:00	1.99	61.32
2-Feb-14	21:15	1.70	45.14
2-Feb-14	21:30	1.72	45.90
2-Feb-14	21:45	1.64	41.84
2-Feb-14	22:00	1.47	33.61
2-Feb-14	22:15	1.53	36.12
2-Feb-14	22:30	1.51	35.34
2-Feb-14	22:45	1.51	35.11
2-Feb-14	23:00	1.58	38.51
2-Feb-14	23:15	1.44	31.88
2-Feb-14	23:30	1.51	35.52
2-Feb-14	23:45	1.44	32.21
3-Feb-14	0:00	1.44	31.85
3-Feb-14	0:15	1.38	29.43
3-Feb-14	0:30	1.29	25.40
3-Feb-14	0:45	1.36	28.51
3-Feb-14	1:00	1.22	22.71
3-Feb-14	1:15	1.29	25.68
3-Feb-14	1:30	1.27	24.93
3-Feb-14	1:45	1.29	25.40
3-Feb-14	2:00	1.32	26.97
3-Feb-14	2:15	1.49	34.29
3-Feb-14	2:30	1.50	34.64
3-Feb-14	2:45	1.45	32.68
3-Feb-14	3:00	1.48	33.94
3-Feb-14	3:15	1.72	45.94
3-Feb-14	3:30	1.53	36.21
3-Feb-14	3:45	1.39	29.88
3-Feb-14	4:00	1.22	22.83

3-Feb-14	4:15	1.21	22.60
3-Feb-14	4:30	1.48	33.96
3-Feb-14	4:45	1.26	24.28
3-Feb-14	5:00	1.15	20.25
3-Feb-14	5:15	1.20	22.16
3-Feb-14	5:30	1.20	22.22

OFFSITE SEWER CAPACITY ANALYSIS

OFFSITE SEWER CAPACITY ANALYSIS SUMMARY

APARTMENT USE: 183.4 gpm for wet-weather

182.5 gpm for dry-weather

CHURCH USE: 99.4 gpm for wet-weather

98.3 gpm for dry-weather

TOTAL SITE: 280.8 gpm for dry-weather

MAX. EXISTING FLOW IN SEWER: 178.7 gpm for dry-weather

TOTAL OF SITE AND MAX. EXISTING: 459.5 gpm for dry-weather

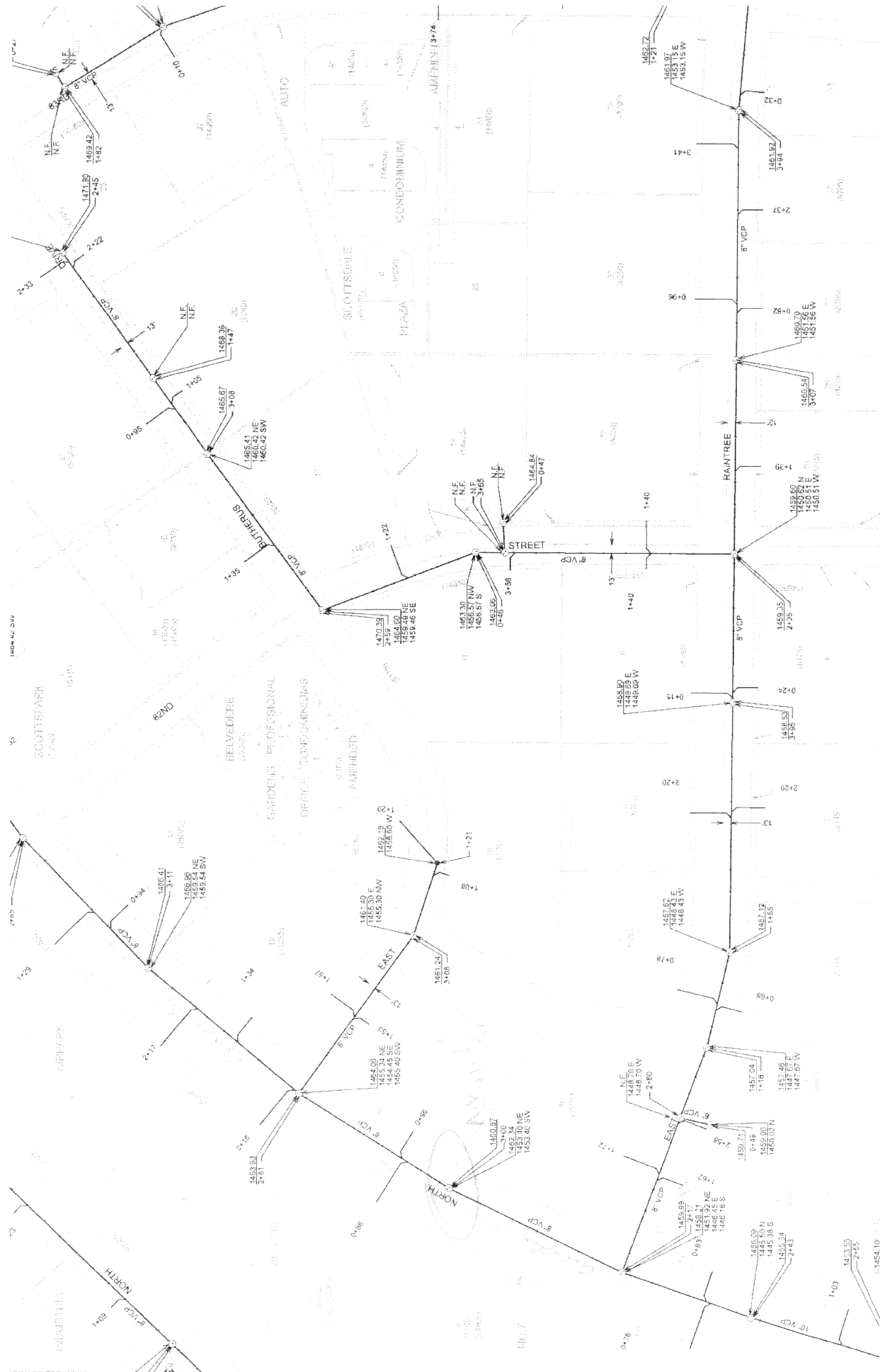

8" PIPE AT 0.48%

Project Description

Friction Method Manning Formula
Solve For Discharge

Input Data

Roughness Coefficient	0.013
Channel Slope	0.00480 ft/ft
Normal Depth	0.43 ft = 5.2" (= 65% of 8" pipe)
Diameter	0.67 ft = 8"
Discharge	0.63 ft ³ /s → 282.8 GPM

Cross Section Image

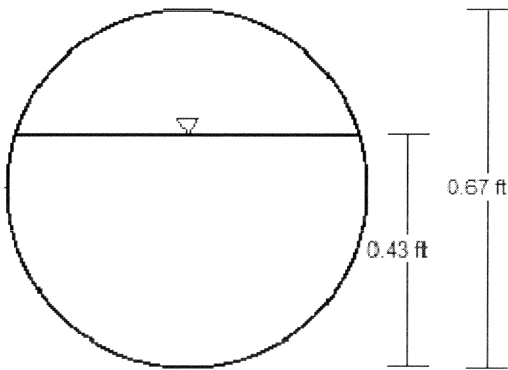

*RESULTING DISCHARGE IS
LESS THAN 459.5 GPM
(NEED PARALLEL PIPE)

V: 1
H: 1