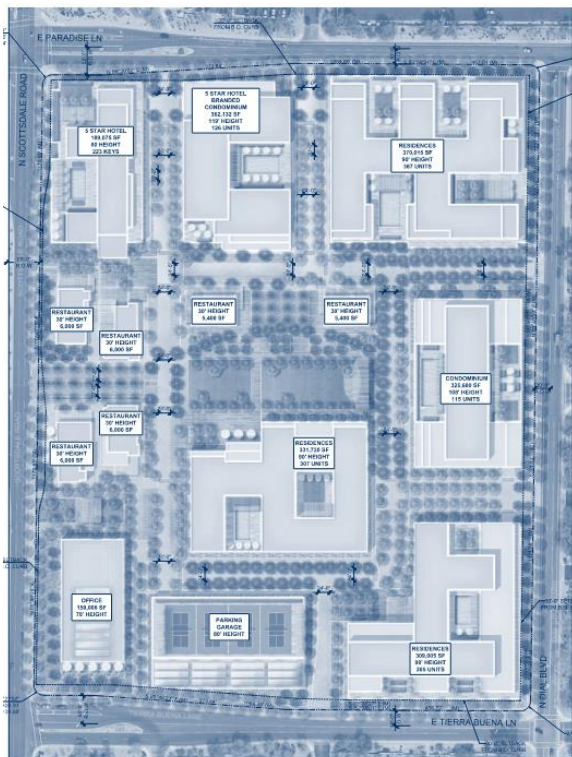




The Parque

Transportation Impact & Mitigation Analysis



Prepared for:



STOCKDALE
CAPITAL PARTNERS

Stockdale Capital Partners, LLC
4501 N. Scottsdale Road, Suite 201
Scottsdale, Arizona 85251



Prepared by:



Lokahi, LLC
10555 N. 114th Street,
Suite 105
Scottsdale, AZ 85259

Project Number: 22.5350
August 22, 2022



TABLE OF CONTENTS:

- 1. Introduction and Executive Summary1**
 - 1.1. Purpose of Report and Study Objectives1
 - 1.2. Executive Summary.....1
- 2. Proposed Development6**
- 3. Area Conditions 11**
 - 3.1. Study Roadway Segments..... 11
 - 3.2. Study Intersections12
 - 3.3. Surrounding Area Land Use.....15
 - 3.4. Site Accessibility 16
 - 3.5. Collision History17
 - 3.6. Collision Rates 19
- 4. Existing Conditions.....20**
 - 4.1. Existing Land Use 20
 - 4.2. Existing Traffic Counts 20
 - 4.3. Existing Capacity Analysis..... 23
- 5. Projected Traffic.....29**
 - 5.1. Trip Generation.....29
 - 5.2. Trip Generation Comparison30
 - 5.3. Trip Distribution and Assignment31
- 6. Future Conditions (Year 2025).....35**
 - 6.1. Year 2025 No Build Traffic Volumes 35
 - 6.2. Year 2025 Build Traffic Volumes 35
 - 6.3. Year 2025 No Build Capacity Analysis..... 35
 - 6.4. Year 2025 Build Capacity Analysis 37
- 7. Future Conditions (Year 2030).....46**
 - 7.1. Year 2030 Background Traffic Volumes.....46
 - 7.2. Year 2030 Build Traffic Volumes.....46
 - 7.3. Year 2030 No Build Capacity Analysis46
 - 7.4. Year 2030 Build Capacity Analysis48
- 8. Queue Analysis56**
- 9. Traffic Signal Warrant.....57**
- 10. Alternative Analysis59**
- 11. Recommendations & Conclusions.....60**





FIGURES:

Figure 1 – Vicinity Map8

Figure 2 – Site Plan.....9

Figure 3 – Study Area 10

Figure 4 – Existing Traffic Volumes 22

Figure 5 – Existing Capacity Analysis28

Figure 6 – Trip Distribution..... 32

Figure 7 – Site Traffic Volumes33

Figure 8 – Pass-by Traffic Volumes34

Figure 9 – Year 2025 No Build Traffic Volumes.....42

Figure 10 – Year 2025 Build Traffic Volumes43

Figure 11 – Year 2025 No Build Capacity Analysis44

Figure 12 – Year 2025 Build Capacity Analysis.....45

Figure 13 – Year 2030 No Build Traffic Volumes 52

Figure 14 – Year 2030 Build Traffic Volumes.....53

Figure 15 – Year 2030 No Build Capacity Analysis54

Figure 16 – Year 2030 Build Capacity Analysis55

TABLES:

Table 1 – Collision Rates - Study Roadway Segments 19

Table 2 – Collision Rates - Study Intersections 19

Table 3 – Level of Service Criteria 23

Table 4 – Existing Level of Service and Delay – Unsignalized25

Table 5 – Existing Level of Service and Delay – Signalized26

Table 6 – Trip Generation – Proposed Development.....30

Table 8 – Trip Generation Comparison – Existing Zoning..... 31

Table 9 – Year 2025 Level of Service and Delay – Unsignalized39

Table 10 – Year 2025 Level of Service and Delay – Signalized40

Table 11 – Year 2030 Level of Service and Delay – Unsignalized49

Table 12 – Year 2030 Level of Service and Delay – Signalized50

Table 13 – Queue Analysis.....56

Table 14 – Signal Warrant Analysis Results.....58

Table 15 – Dial Boulevard and Paradise Lane Alternative Comparison59





APPENDICES:

Appendix A – Proposed Site Plan..... A

Appendix B – Collision Data B

Appendix C – Parcel Information C

Appendix D – Traffic Count Data D

Appendix E – Signal Timing E

Appendix F – Existing Capacity Analysis..... F

Appendix G – Trip Generation G

Appendix H – La Via Traffic Impact & Mitigation Analysis, dated September 13, 2018 H

Appendix I – Year 2025 No Build Capacity Analysis I

Appendix J – Year 2025 Build Capacity Analysis..... J

Appendix K – Year 2030 No Build Capacity Analysis..... K

Appendix L – Year 2030 Build Capacity Analysis L

Appendix M – Traffic Signal Warrant Analysis M

Appendix N – Dial Boulevard and Paradise Lane Alternative Analysis N





1. INTRODUCTION AND EXECUTIVE SUMMARY

1.1. PURPOSE OF REPORT AND STUDY OBJECTIVES

Lōkahi, LLC (Lōkahi) was retained by Stockdale Capital Partners, LLC to complete a Transportation Impact and Mitigation Analysis for The Parque development, located on the southeast corner of Scottsdale Road and Paradise Lane, in Scottsdale, Arizona. The objective of this Transportation Impact and Mitigation Analysis is to analyze the traffic related impacts of the proposed development to the adjacent roadway network. See **Figure 1** for the vicinity map.

1.2. EXECUTIVE SUMMARY

The proposed development is located on the southeast corner of Scottsdale Road and Paradise Lane in the City of Scottsdale, Arizona. The Parque development will be comprised of the following land uses:

- **Multi-Family Residential** **1,236 units**
 - *5 Star Hotel Branded Condominiums* 126 units
 - *Luxury Condominiums* 115 units
 - *Multi-Family Residencies* 897 units
 - *Work Force Residences* 98 units
- **Hotel** **223 rooms**
- **Retail** **25,250 square feet**
- **Restaurant** **35,120 square feet**
- **Office** **150,000 square feet**

This Transportation Impact and Mitigation Analysis includes:

- Level of service analysis of existing conditions for the weekday AM and PM peak hours
- Trip Generation for the proposed development
- Trip Generation comparison to previously proposed development
- Level of service analysis for the opening year (2025) weekday AM and PM peak hours
- Level of service analysis for 5 years after the opening year (2030) weekday AM and PM peak hours

The following are the existing intersections included in this study:

- Scottsdale Road and Bell Road/Frank Lloyd Wright Boulevard (1)
- Scottsdale Road and Paradise Lane (2)
- Scottsdale Road and Driveway A (3)
- Scottsdale Road and Tierra Buena Lane (4)





- Scottsdale Road and Kierland Boulevard/Greenway Hayden Loop (5)
- Scottsdale Road and Greenway Parkway/Butherus Drive (6)
- Paradise Lane and Driveway C (8)
- Dial Boulevard and Paradise Lane (9)
- Dial Boulevard and Monte Cristo Avenue (11)
- Dial Boulevard and Driveway E (12)
- Tierra Buena Lane and Driveway F (13)
- Dial Boulevard and Tierra Buena Lane (14)
- Dial Boulevard/73rd Street and Greenway Hayden Loop (15)
- Frank Lloyd Wright Boulevard and 76th Street (16)
- Paradise Lane and 76th Street (17)
- Greenway Hayden Loop and Frank Lloyd Wright Boulevard (18)
- Greenway Hayden Loop and Paradise Lane (19)

Existing Capacity Analysis

The AM and PM peak hour existing conditions capacity analysis were completed for the existing study intersections. The results of the capacity analysis reveal the following location with an existing level of service (LOS) E or F:

Scottsdale Road and Bell Road/Frank Lloyd Wright Boulevard (1)

- Eastbound left PM peak hour operates at LOS F
- Westbound left AM and PM peak hours operate at LOS E
- Westbound through PM peak hour operates at LOS E
- Northbound left AM and PM peak hours operate at LOS E
- Northbound through AM and PM peak hours operate at LOS E

Scottsdale Road and Paradise Lane (2)

- Overall intersection AM and PM peak hours operate at LOS E
- Eastbound left PM peak hour operates at LOS E
- Northbound through AM and PM peak hours operate at LOS E
- Southbound through AM and PM peak hours operate at LOS E

Scottsdale Road and Tierra Buena Lane (4)

- Westbound through AM peak hour operates at LOS F



Scottsdale Road and Kierland Boulevard/Greenway Hayden Loop (5)

- Eastbound left PM peak hour operates at LOS E
- Eastbound through AM and PM peak hours operate at LOS E
- Westbound left AM and PM peak hours operate at LOS E
- Westbound through AM and PM peak hours operate at LOS E
- Westbound shared through-right AM and PM peak hours operate at LOS E

Scottsdale Road and Greenway Parkway/Butherus Drive (6)

- Eastbound left PM peak hour operates at LOS E
- Westbound left AM peak hour operates at LOS E
- Southbound left AM and PM peak hours operate at LOS E

Dial Boulevard/73rd Street and Greenway Hayden Loop (15)

- Overall intersection AM and PM peak hours operate at LOS E
- Eastbound through AM and PM peak hours operate at LOS E
- Eastbound shared through-right AM and PM peak hours operate at LOS E
- Westbound through AM peak hour operates at LOS E

Greenway Hayden Loop and Frank Lloyd Wright Boulevard (18)

- Overall intersection AM and PM peak hours operate at LOS E
- Eastbound left PM peak hour operates at LOS E
- Eastbound through PM peak hour operates at LOS E
- Northbound left AM peak hour operates at LOS E
- Northbound through AM and PM peak hours operate at LOS E
- Southbound left AM and PM peak hours operate at LOS F and E, respectively
- Southbound through AM and PM peak hours operate at LOS F and E, respectively

Greenway Hayden Loop and Paradise Lane (19)

- Eastbound shared left-through PM peak hour operates at LOS E
- Westbound shared left-through PM peak hour operates at LOS E

Trip Generation

The proposed development is anticipated to generate 10,520 new weekday trips with 860 occurring during the AM peak hour and 875 trips during the PM peak hour.

Trip Generation Comparison

A trip generation comparison was completed for the proposed developments versus the existing zoning. The Parque is anticipated to generate 12,379 fewer weekday daily trips, with 271 and 1,210 fewer trips during the AM and PM peak hours, respectively, versus the existing zoning.

Future Conditions - Year 2025 (Opening Year)





The opening of the proposed development is anticipated to occur during the year 2025. Therefore, year 2025 analyses was completed with and without the build out of the proposed development. An annual growth rate of 2.5% was applied to the existing traffic volumes.

A capacity analysis was completed for both the AM and PM peak hours for year 2025, with and without the build out of the proposed development. All movements operate at a LOS D or better or are maintained at the year 2025 no build level of service, with the exception of:

Scottsdale Road and Bell Road/Frank Lloyd Wright Boulevard (1)

- Overall intersection PM peak hour operates at LOS E

Scottsdale Road and Tierra Buena Lane (4)

- Eastbound shared through-right PM peak hour operates at LOS E

Scottsdale Road and Kierland Boulevard/Greenway Hayden Loop (5)

- Southbound through PM peak hour operates at LOS E
- Southbound right AM peak hour operates at LOS E

Greenway Hayden Loop and Paradise Lane (19)

- Eastbound shared left-through AM and PM peak hours operate at LOS F

Future Conditions - Year 2030 (5 Years After Opening Year)

A capacity analysis was completed for both the AM and PM peak hours for year 2030, with and without the build out of the proposed development. All movements operate at a LOS D or better or are maintained at the year 2030 no build level of service, with the exception of:

Scottsdale Road and Bell Road/Frank Lloyd Wright Boulevard (1)

- Eastbound right AM peak hour operates at LOS E

Scottsdale Road and Tierra Buena Lane (4)

- Eastbound shared through-right PM peak hour operates at LOS E

Greenway Hayden Loop and Frank Lloyd Wright Boulevard (18)

- Westbound left PM peak hour operates at LOS E

Greenway Hayden Loop and Paradise Lane (19)

- Westbound shared left-through AM peak hour operates at LOS F



Traffic Signal Warrant

Traffic signal warrant analysis was completed utilizing the methodology defined in the 2009 Manual on Uniform Traffic Control Devices (MUTCD) with the year 2025 build traffic volumes for the following intersections:

- Scottsdale Road and Tierra Buena Lane (4) – **Traffic Signal Warranted**
- Greenway Hayden Loop and Paradise Lane (19) – **Traffic Signal Not Warranted**

Recommendations

The following are the recommendations with the build out of the proposed development:

Scottsdale Road and Driveway A (3)

- Build out of a three-quarter access driveway, allowing right-in, left-in, and right-out movements. Improvements include installation of northbound right turn deceleration lane and a southbound left turn lane.

Scottsdale Road and Tierra Buena Lane (4)

- Installation of a traffic signal.

Paradise Lane and Driveway B (7)

- Build out of a right-in and right-out driveway.

Paradise Lane and Driveway C (8)

- Build out of a full access driveway on the south leg of the existing intersection.

Dial Boulevard and Driveway D (10)

- Build out of a full access driveway on the south leg of the existing intersection.

Dial Boulevard and Driveway E (12)

- Modification to the west leg of the existing intersection on the to accommodate the full access site driveway.

Tierra Buena Lane and Driveway F (13)

- Modification to the north leg of the existing intersection on the to accommodate the site driveway.



2. PROPOSED DEVELOPMENT

The proposed development is located on the southeast corner of Scottsdale Road and Paradise Lane in the City of Scottsdale, Arizona. The Parque development will be comprised of the following land uses:

- **Multi-Family Residential** **1,236 units**
 - *5 Star Hotel Branded Condominiums* 126 units
 - *Luxury Condominiums* 115 units
 - *Multi-Family Residencies* 897 units
 - *Work Force Residences* 98 units
- **Hotel** **223 rooms**
- **Retail** **25,250 square feet**
- **Restaurant** **35,120 square feet**
- **Office** **150,000 square feet**

The opening of the proposed development is anticipated to occur during the year 2025.

See **Figure 2** and **Appendix A** for the proposed site plan.

There will be a total of six (6) access points to serve the proposed The Parque development; with one (1) located along Scottsdale Road two (2) located along Paradise Lane, two (2) located along Dial Boulevard, and one (1) located along Tierra Buena Lane:

Scottsdale Road and Driveway A (3) is located approximately 650 feet south of Paradise Lane and will align with an existing driveway on the west side of Scottsdale Road. This proposed driveway will be limited to right-in, right-out, and left-in movements, which mirrors the movements allowed for the driveway on the west side of Scottsdale Road.

Paradise Lane and Driveway B (7) is located approximately 275 feet east of Scottsdale Road. This driveway will provide for right-in and right-out movements only.

Paradise Lane and Driveway C (8) is located approximately 555 feet east of Scottsdale Road and will align with an existing driveway on the north side of Paradise Lane. This driveway will provide full access, allowing all movements into and out of the site.

Dial Boulevard and Driveway D (10) is located approximately 410 feet south of Paradise Lane. This driveway will provide full access, allowing all movements into and out of the site.



Dial Boulevard and Driveway E (12) is located approximately 180 feet south of Monte Cristo Avenue and aligns with an existing driveway on the east side of Dial Boulevard. This driveway will provide full access, allowing all movements into and out of the site.

Tierra Buena Lane and Driveway F (13) is located approximately 600 feet east of Scottsdale Road and aligns with an existing driveway on the south side of Tierra Buena Lane. This driveway will provide full access, allowing all movements into and out of the site.

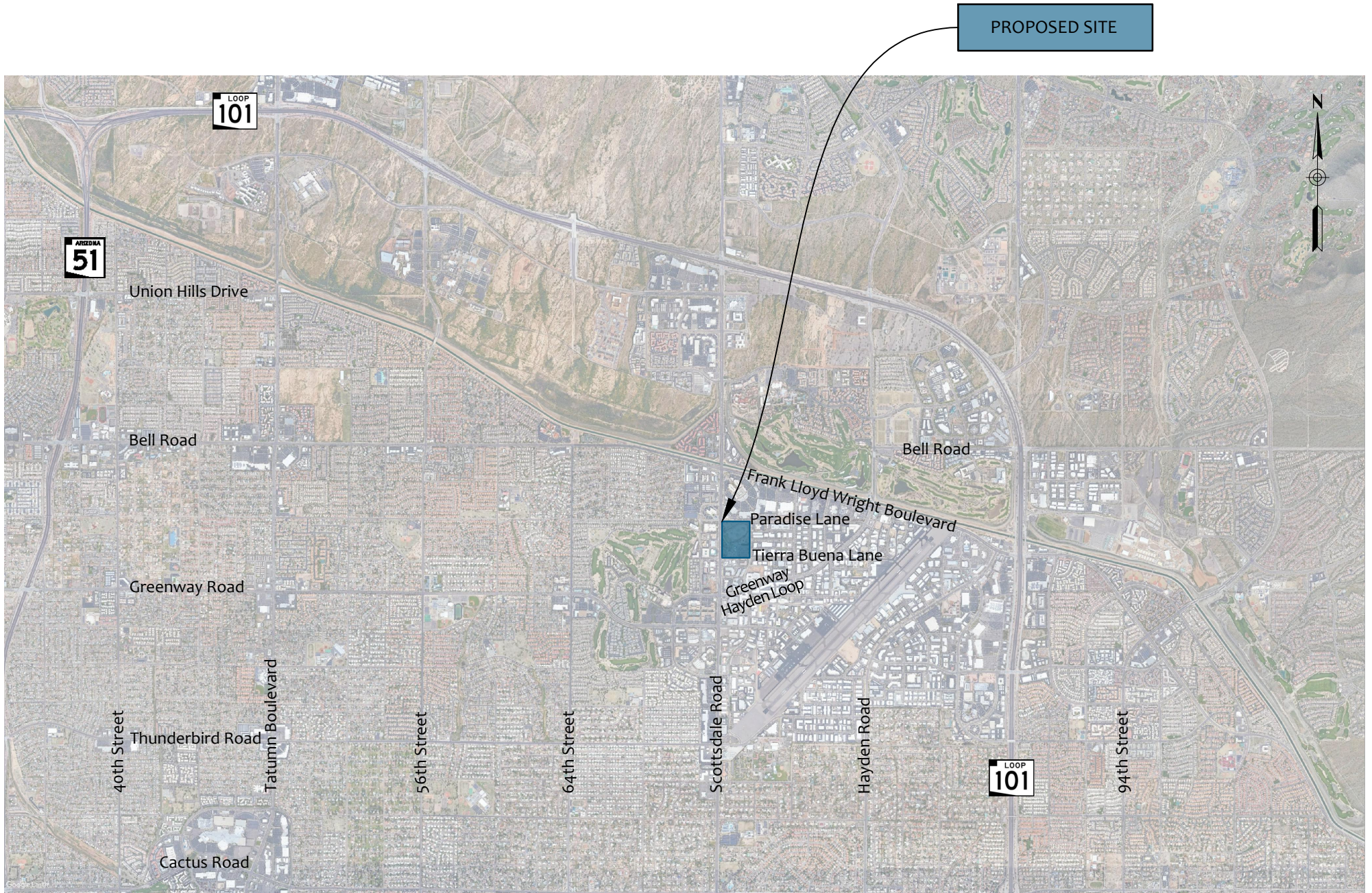


FIGURE 1 | VICINITY MAP

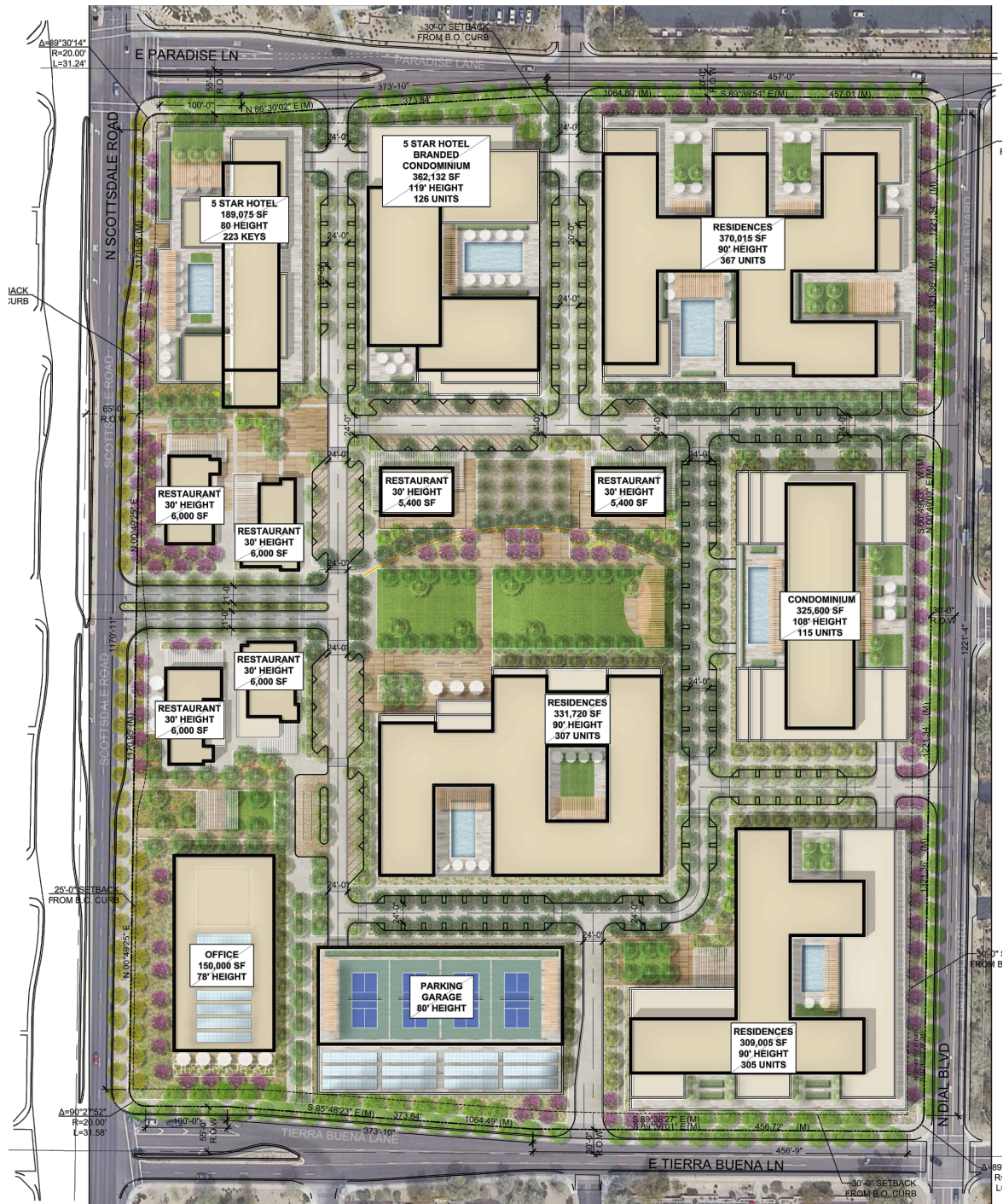


FIGURE 2 | SITE PLAN

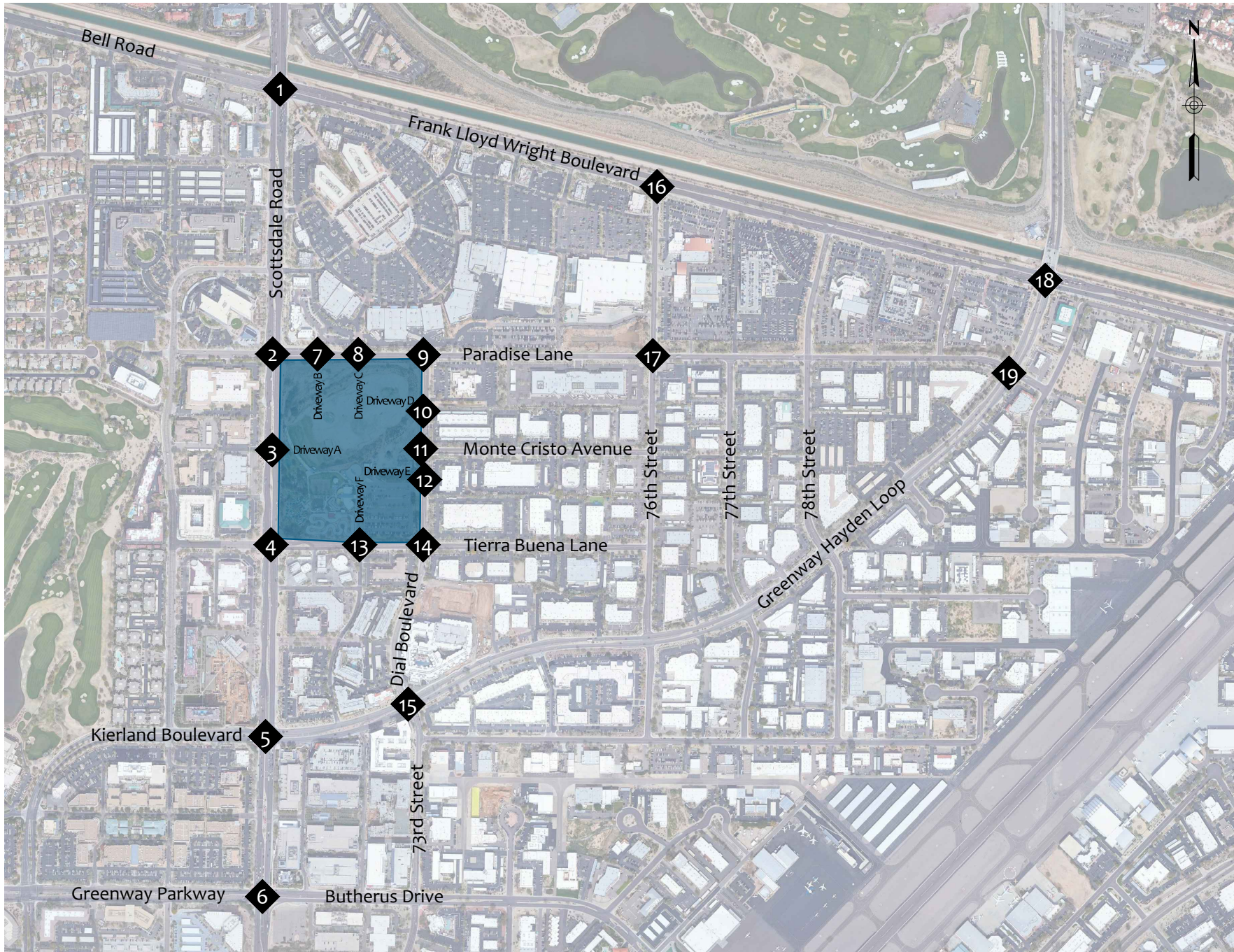


FIGURE 3 | STUDY AREA



3. AREA CONDITIONS

The study area is located in the City of Phoenix, Arizona. **Sections 3.1** and **3.2** provide detailed descriptions of the study roadway segments and intersections. See **Figure 3** for study area.

3.1. STUDY ROADWAY SEGMENTS

Scottsdale Road runs north-south adjacent to the proposed development and provides three through lanes for each direction of travel with a raised landscaped median. There is a posted speed limit of 45 miles per hour (mph). The City of Scottsdale classifies Scottsdale Road as a major arterial according to the *City of Scottsdale Master Transportation Plan*, adopted on July 5, 2016. The City of Scottsdale's 2020 *Average Daily Segment Traffic Volumes* map indicates that 33,300 vehicles per day were recorded along Scottsdale Road between Kierland Boulevard/Greenway Hayden Loop and Frank Lloyd Wright Boulevard/Bell Road.

Bell Road/Frank Lloyd Wright Boulevard, generally runs east-west in the vicinity of the proposed development, and provides three through lanes for each direction of travel with a raised landscaped median. Frank Lloyd Wright Boulevard continues west of Scottsdale Road as Bell Road. There is a posted speed limit of 45 mph. The City of Scottsdale classifies Frank Lloyd Wright Boulevard as a major arterial according to the *City of Scottsdale Master Transportation Plan*, adopted on July 5, 2016. The City of Scottsdale's 2020 *Average Daily Segment Traffic Volumes* map indicates that 33,800 vehicles per day were recorded along Frank Lloyd Wright Boulevard between Scottsdale Road and Greenway Hayden Loop.

Kierland Boulevard/Greenway Hayden Loop generally runs east-west and provides three through lanes for each direction of travel with a raised median west of Dial Boulevard, it provides two through lanes for each direction of travel east of Dial Boulevard. Greenway Hayden Loop is known as Kierland Boulevard west of Scottsdale Road. There is a posted speed limit of 40 mph. The City of Scottsdale classifies Greenway Hayden Loop as a minor arterial according to the *City of Scottsdale Master Transportation Plan*, adopted on July 5, 2016. The City of Scottsdale's 2020 *Average Daily Segment Traffic Volumes* map indicates that 16,800 vehicles per day were recorded along Greenway Hayden Loop between Scottsdale Road and Frank Lloyd Wright Boulevard.

Greenway Parkway/Butherus Drive runs east-west in the vicinity of the proposed development and provides two through lanes for each direction with a raised median east of Scottsdale Road. Butherus Drive continues west of Scottsdale Road as Greenway Parkway and provides three lanes for each direction with a raised median. There is a posted speed limit of 35 mph east and 45 mph west of Scottsdale Road, respectively. The City of Scottsdale classifies Butherus Drive as a minor arterial according to the *City of Scottsdale Master Transportation Plan*, adopted on July 5, 2016. Butherus Drive terminates at the Scottsdale Municipal Airport approximately ½ mile east of Scottsdale Road.



Paradise Lane runs east west adjacent to the proposed development and provides one through lane for each direction of travel with a two-way left turn lane. There is a posted speed limit of 35 mph. The City of Scottsdale classifies Paradise Lane as a minor collector according to the *City of Scottsdale Master Transportation Plan*, adopted on July 5, 2016. Paradise Lane terminates to the west approximately 700 feet west at 71st Street and terminates to the east approximately 300 feet east of Greenway Hayden Loop.

Tierra Buena Lane runs east-west adjacent to the proposed development and provides one through lane for each direction of travel with a center two-way left turn lane. There is a posted speed limit of 30 mph. Tierra Buena Lane is approximately two-thirds (0.66) of a mile long segment between 71st Street and 76th Street.

Dial Boulevard runs north-south adjacent to the proposed development and provides one through lane for each direction of travel with a two-way left turn lane. There is a posted speed limit of 30 mph. The City of Scottsdale classifies Dial Boulevard as a minor collector according to the *City of Scottsdale Master Transportation Plan*, adopted on July 5, 2016.

76th Street runs north-south in the vicinity of the proposed development and provides one through lane for each direction of travel with a two-way left turn lane. There is a posted speed limit of 30 mph. The City of Scottsdale classifies 76th Street as a minor collector according to the *City of Scottsdale Master Transportation Plan*, adopted on July 5, 2016. 76th Street is approximately seven-tenths (0.70) of a mile long segment between Frank Lloyd Wright Boulevard and Greenway Road within the proposed study area.

Monte Cristo Avenue runs east-west in the vicinity of the proposed development and provides one through lane for each direction of travel. There is an unposted speed limit of 25 mph. Monte Cristo Avenue is approximately one-third (0.33) of a mile long roadway between Dial Boulevard and 76th Street.

3.2. STUDY INTERSECTIONS

Scottsdale Road and Bell Road/Frank Lloyd Wright Boulevard (1) currently operates as a signalized intersection. The northbound approach provides two (2) dedicated left turn lanes, three (3) through lanes, and one (1) dedicated right turn lane. The southbound approach provides two (2) dedicated left turn lanes, two (2) through lanes, and one (1) shared through-right turn lane. The eastbound approach provides two (2) dedicated left turn lanes, three (3) through lanes, and one (1) dedicated right turn lane. The westbound approach provides two (2) dedicated left turn lanes, three (3) through lanes, and one (1) dedicated right turn lane.

Scottsdale Road and Paradise Lane (2) currently operates as a signalized intersection. The northbound approach provides one (1) dedicated left turn lane, three (3) through lanes, and one (1) dedicated right turn lane. The southbound approach provides one (1) dedicated left turn lane, three



(3) through lanes, and one (1) dedicated right turn lane. The eastbound approach provides one (1) dedicated left turn lane, (1) through lane, and one (1) dedicated right turn lane. The westbound approach provides one (1) dedicated left turn lane, one (1) through lane, and one (1) dedicated right turn lane.

Scottsdale Road and Driveway A (3) currently operates as a one-way stop controlled T-intersection with stop control on the eastbound approach. The northbound approach provides one (1) dedicated left turn lane and three (3) through lanes. The southbound approach provides three (3) through lanes and one (1) dedicated right turn lane. The eastbound approach provides one (1) dedicated right turn lane.

Scottsdale Road and Tierra Buena Lane (4) currently operates as a two-way stop controlled intersection, with stop control on the eastbound and westbound approaches. The northbound approach provides one (1) dedicated left turn lane, three (3) through lanes, and one (1) dedicated right turn lane. The southbound approach provides one (1) dedicated left turn lane, three (3) through lanes, and one (1) dedicated right turn lane. The eastbound approach currently has no pavement markings with approximately 50 feet of pavement. There is sufficient width for one (1) left lane and one (1) shared through-right turn lane, which was the assumed geometrics for the purposes of this study. The westbound approach provides one (1) dedicated left turn lane, one (1) through lane, and one (1) dedicated right turn lane.

Scottsdale Road and Kierland Boulevard/Greenway Hayden Loop (5) currently operates as a signalized intersection. The northbound approach provides two (2) dedicated left turn lanes, three (3) through lanes, and one (1) dedicated right turn lane. The southbound approach provides two (2) dedicated left turn lanes, three (3) through lanes, and one (1) dedicated right turn lane. The eastbound approach provides two (2) dedicated left turn lanes, two (2) through lanes, and one (1) dedicated-right turn lane. The westbound approach provides two (2) dedicated left turn lanes, two (2) through lanes, and one (1) shared through-right turn lane.

Scottsdale Road and Greenway Parkway/Butherus Drive (6) currently operates as a signalized intersection. The northbound approach provides two (2) dedicated left turn lanes, three (3) through lanes, and one (1) channelized right turn lane. The southbound approach provides two (2) dedicated left turn lanes, three (3) through lanes, and one (1) dedicated right turn lane. The eastbound approach provides two (2) dedicated left turn lanes, a through lane, a shared through-right turn lane, and a dedicated right turn lane. The westbound approach provides two (2) dedicated left turn lanes, two (2) through lanes, and one (1) dedicated right turn lane.

Paradise Lane and Driveway C (8) currently operates as a one-way stop controlled T-intersection with stop control on the southbound approach. The southbound approach provides one (1) left-right turn lane. The eastbound approach provides one (1) dedicated left turn lane (via a two-way



left-turn lane) and one (1) through lane. The westbound approach provides one (1) shared through-right turn lane.

Dial Boulevard and Paradise Lane (9) currently operates as a one-way stop controlled T-intersection with stop control on the northbound approach. The northbound approach provides one (1) dedicated left turn lane, and one (1) dedicated right turn lane. The eastbound approach provides one (1) shared through-right turn lane. The westbound approach provides one (1) dedicated left turn lane and one (1) through lane.

Dial Boulevard and Monte Cristo Avenue (11) currently operates as a one-way stop controlled T-intersection with stop control on the westbound approach. The northbound approach provides one (1) shared through-right turn lane. The southbound approach provides one (1) dedicated left turn lane (via a two-way left-turn lane) and one (1) through lane. The westbound approach provides one (1) dedicated left turn lane and one (1) dedicated right turn lane.

Dial Boulevard and Driveway E (12) currently operates as a one-way stop controlled T-intersection with stop control on the westbound approach. The northbound approach provides one (1) shared through-right turn lane. The southbound approach provides one (1) dedicated left turn lane (via a two-way left-turn lane) and one (1) through lane. The eastbound and westbound approaches provide one (1) shared left-through-right turn lane.

Tierra Buena Lane and Driveway F (13) currently operates as a one-way stop controlled T-intersection with stop control on the northbound approach. The northbound approach provides one (1) shared left-right turn lane. The eastbound approach provides one (1) through lane and one (1) shared through-right turn lane. The westbound approach provides one (1) dedicated left turn lane (via a two-way left-turn lane) and one (1) through lane.

Dial Boulevard and Tierra Buena Lane (14) currently operates as a four-way stop controlled intersection. All four (4) approaches provide one (1) dedicated left turn lane and one (1) shared through-right turn lane.

Dial Boulevard/73rd Street and Greenway Hayden Loop (15) currently operates as a signalized intersection. The northbound approach provides one (1) dedicated left turn lane, one (1) through lane, and one (1) dedicated right turn lane. The southbound approach provides one (1) dedicated left turn lane, one (1) through lane, and one (1) dedicated right turn lane. The eastbound approach provides one (1) dedicated left turn lane, two (2) through lanes, and one (1) shared through-right turn lane. The westbound approach provides one (1) dedicated left turn lane, two (2) through lanes, and one (1) dedicated right turn lane.

Frank Lloyd Wright Boulevard and 76th Street (16) currently operates as a signalized T-intersection. The northbound approach provides two (2) dedicated left turn lanes, and one (1) dedicated right



turn lane. The eastbound approach provides three (3) through lanes, and one (1) dedicated right turn lane. The westbound approach provides one (1) dedicated left turn lane, and three (3) through lanes.

Paradise Lane and 76th Street (17) currently operates as a four-way stop controlled intersection. All four (4) approaches provide one (1) dedicated left turn lane and one (1) shared through-right turn lane.

Greenway Hayden Loop and Frank Lloyd Wright Boulevard (18) currently operates as a signalized intersection. The northbound approach provides one (1) dedicated left turn lane, two (2) through lanes, and one (1) dedicated right turn lane. The southbound approach provides two (2) dedicated left turn lanes, two (2) through lanes, and one (1) dedicated right turn lane. The eastbound approach provides two (2) dedicated left turn lanes, three (3) through lanes, and one (1) dedicated right turn lane. The westbound approach provides two (2) dedicated left turn lanes, three (3) through lanes, and one (1) dedicated right turn lane.

Greenway Hayden Loop and Paradise Lane (19) currently operates as a two-way stop controlled intersection, with stop control on the eastbound and westbound approaches. The northbound approach provides one (1) dedicated left turn lane, two (2) through lanes, and one (1) dedicated right turn lane. The southbound approach provides one (1) dedicated left turn lane, two (2) through lanes, and one (1) dedicated right turn lane. The eastbound approach provides one (1) shared left-through lane and one (1) dedicated right turn lane. The westbound approach provides one (1) shared left-through turn lane and one (1) dedicated right turn lane.

3.3. SURROUNDING AREA LAND USE

The surrounding area includes a mix of residential, office, hotel, restaurant, retail, and airport land uses. Scottsdale Quarter and Kierland Commons mixed-use developments are located approximately one-quarter (0.25) mile to the south and includes residential, office, retail and restaurant land uses. The proposed The Parque development is located approximately one-half (0.50) mile southwest of The Westin Kierland Resort and Spa, approximately one-half (0.50) mile southeast of the Scottsdale Municipal Airport, and approximately one (1) mile northeast of TPC Scottsdale Golf Course. Retail land uses are located immediately to the west, east and north (Promenade Shopping Center) of the proposed development. A gas station with a car wash and a hotel are located immediately to the south of the proposed development.





3.4. SITE ACCESSIBILITY

Roadway System

The study area is located in the City of Scottsdale, Arizona approximately two (2) miles south and west of SR 101L. Scottsdale's street network is generally built as a one-mile grid system and within the near vicinity of the proposed site, there is a well-developed roadway network. Although the roadways within the study area somewhat deviate from the grid, north-south and east-west arterial roadway connections are maintained and provide a convenient access to SR 101L freeway interchanges.

Pedestrian Facilities

Continuous sidewalks are generally provided along the study roadway segments within the study area.

Marked crosswalks are currently provided along each crossing at the signalized intersections and four-way stop controlled intersection. Additionally, crosswalks are provided at one-way stop controlled intersections on the stop controlled approach.

Bicycle Facilities

According to the *Scottsdale Master Transportation Plan*, dated July 2016 there are no existing bicycle facilities and shared-use paths adjacent to the proposed The Parque development. There are existing bike lanes on Scottsdale Road, Greenway Hayden Loop north of Frank Lloyd Wright Boulevard, and Paradise Lane between Scottsdale Road and Greenway Hayden Loop. Paradise Lane and 73rd Street provide on-street bike lanes in both directions of travel, within the study area.

The *Scottsdale Master Transportation Plan* identifies 76th Street from Frank Lloyd Wright Boulevard to Greenway Hayden Loop, and Dial Boulevard from Paradise Lane to Thunderbird Road as a high priority future shared-use path.

Transit Facilities

The City of Phoenix operates Route 170, which runs along Bell Road/Frank Lloyd Wright Boulevard. Within the segment of Frank Lloyd Wright between Scottsdale Road and Greenway Hayden Loop Route 170 provides two sheltered bus stops in the westbound direction and three (3) stops in eastbound direction, of which two are sheltered. This transit service typically runs from 4:00 am to 1:00 am on weekdays and 5:00 am to 12:00 am on weekends.

Valley Metro operates Route 72, which runs along Scottsdale Road adjacent to the proposed development. Within the segment of Scottsdale Road between Frank Lloyd Wright Boulevard and Greenway Parkway/Butherus Drive Route 72 provides four sheltered bus stops in the southbound direction and four stops in the northbound direction, of which three are sheltered. This transit service typically runs from 5:00 am to 1:00 am on weekdays and 5:00 am to 12:30 am on weekends.





The closest to the site northbound bus stop is located on Scottsdale Road approximately 240 feet north of Tierra Buena Lane, while the closest southbound bus stop is located on Scottsdale Road approximately 175 feet south of Paradise Lane.

A Park and Ride lot is located on the southeast corner of Scottsdale Road and Thunderbird Road, which is approximately 1 ¼ mile south of the proposed development.

According to the *Scottsdale Master Transportation Plan*, dated July 2016, a future Airpark Trolley Route will be provided to serve the airpark area. Three separate routes will provide access to the neighborhoods in the immediate vicinity of the Scottsdale Municipal Airport. The Airpark Trolley will run north-south along Dial Boulevard between Paradise Lane and the existing Thunderbird Road Park and Ride facility.

3.5. COLLISION HISTORY

The most recent 3-year collision history, from July 2019 to July 2022, was obtained from the City of Scottsdale. See **Appendix B** for collision data. The data included the following intersections:

- Scottsdale Road and Bell Road/Frank Lloyd Wright Boulevard (1)
- Scottsdale Road and Paradise Lane (2)
- Scottsdale Road and Tierra Buena Lane (4)
- Scottsdale Road and Kierland Boulevard/Greenway Hayden Loop (5)
- Scottsdale Road and Greenway Parkway/Butherford Drive (6)
- Dial Boulevard and Paradise Lane (9)
- Dial Boulevard and Tierra Buena Lane (14)
- Dial Boulevard/73rd Street and Greenway Hayden Loop (15)
- Frank Lloyd Wright Boulevard and 76th Street (16)
- Paradise Lane and 76th Street (17)
- Greenway Hayden Loop and Frank Lloyd Wright Boulevard (18)
- Greenway Hayden Loop and Paradise Lane (19)

Scottsdale Road and Bell Road/Frank Lloyd Wright Boulevard (1)

During the three-year period, there were a total of 58 crashes, of which 12 were possible injuries, 2 non incapacitating injuries, and 1 incapacitating injury, with the remaining being property damage only. There was a total of 35 rear end, 9 angle, 6 sideswipe same direction, 5 left turn, 1 single vehicle, 1 head on, and 1 sideswipe opposite direction collisions.

Scottsdale Road and Paradise Lane (2)

During the three-year period, there were a total of 20 crashes, of which 2 were possible injuries, 1 non incapacitating injury, and 1 incapacitating injury, with the remaining being property damage



only. There was a total of 7 rear end, 5 angle, 4 sideswipe same direction, 2 single vehicle, 1 left turn, and 1 other collisions.

Scottsdale Road and Tierra Buena Lane (4)

During the three-year period, there were a total of 3 crashes, of which 1 was possible injury and 2 no injury was reported. There was a total of 2 left turn and 1 sideswipe same direction collisions.

Scottsdale Road and Kierland Boulevard/Greenway Hayden Loop (5)

During the three-year period, there were a total of 29 crashes, of which 7 were possible injuries, 2 non incapacitating injuries, 2 unknowns, with the remaining being property damage only. There was a total of 15 rear end, 7 angle, 3 side swipe same direction, 2 left turn, 1 head on, and 1 unknown collisions.

Scottsdale Road and Greenway Parkway/Butherus Drive (6)

During the three-year period, there were a total of 20 crashes, of which 5 were possible injuries, 1 non incapacitating injury, 1 unknown, with the remaining being property damage only. There was a total of 9 rear end, 3 angle, 3 left turn, 3 side swipe same direction, 1 single vehicle, and 1 unknown collisions.

Dial Boulevard and Paradise Lane (9)

During the three-year period, there were a total of 3 crashes, of which all 3 were property damage only. There was a total of 1 angle, 1 left turn, and 1 rear end collisions.

Dial Boulevard and Tierra Buena Lane (14)

During the three-year period, there were a total of 1 crash, of which was an angle collision and resulted in no injury.

Dial Boulevard/73rd Street and Greenway Hayden Loop (15)

During the three-year period, there were a total of 18 crashes, of which 4 were possible injuries, 3 non incapacitating injury, with the remaining being property damage only. There was a total of 5 angle, 5 left turn, 3 single vehicle, 3 sideswipe same direction, and 2 rear end collisions.

Frank Lloyd Wright Boulevard and 76th Street (16)

During the three-year period, there were a total of 22 crashes, of which 2 were possible injuries, 2 non incapacitating injury, with the remaining being property damage only. There was a total of 7 rear end, 6 angle, 5 side swipe same direction, 3 rear end, and 1 rear to side collisions.

Paradise Lane and 76th Street (17)

During the three-year period, there were a total of 3 crashes, of which all 3 were property damage only. There was a total of 3 angle collisions.



Greenway Hayden Loop and Frank Lloyd Wright Boulevard (18)

During the three-year period, there were a total of 93 crashes, of which 15 were possible injuries, 4 non-incapacitating injuries, with the remaining being property damage only. There was a total of 63 read end, 13 angle, 10 sideswipe same direction, 2 single vehicle, 2 head on, 2 sideswipe opposite direction, and 1 rear to side collisions.

Greenway Hayden Loop and Paradise Lane (19)

During the three-year period, there were a total of 10 crashes, of which 1 were possible injury, 3 non-incapacitating injuries, with the remaining being property damage only. There was a total of 5 angle, 2 left turn, 1 rear end, 1 sideswipe same direction, and 1 sideswipe opposite direction collisions.

3.6. COLLISION RATES

The City of Scottsdale’s 2020 Traffic Volume and Collision Rate Data report provides collision rate and traffic volume information on major roadway segments and at major intersections within the City. Segment collisions are collisions that occur on a major street more than 100 feet from the major intersections that define the segment, including at minor intersections within the segment. Intersection collisions are collisions that occur at or within 100 feet of a major intersection.

The collision rates and city-wide rankings for the study roadway segments are shown in **Table 1**. The collision rates and city-wide rankings for the study intersections are shown in **Table 2**.

Table 1 – Collision Rates - Study Roadway Segments

Segment	From	To	Collision Rate	Rank
Greenway Hayden Loop	Scottsdale Road	Frank Llyod Wright Boulevard	2.85	43
Scottsdale Road	Paradise Lane	Frank Llyod Wright Boulevard	1.89	78
Scottsdale Road	Butherus Drive	Greenway Hayden Loop	1.23	121
Scottsdale Road	Greenway Hayden Loop	Paradise Lane	0.74	176
Frank Llyod Wright Boulevard	Scottsdale Road	Greenway Hayden Loop	0.00	320
2020 City of Scottsdale Average Segment Collision Rate			1.36	

Table 2 – Collision Rates - Study Intersections

Intersection	Collision Rate	Rank
Greenway Hayden Loop and Frank Llyod Wright Boulevard	0.99	27
Scottsdale Road and Greenway Hayden Loop	0.65	70
Scottsdale Road and Frank Llyod Wright Boulevard	0.63	71
Scottsdale Road and Greenway Parkway/Butherus Drive	0.23	160
2020 City of Scottsdale Average Intersection Collision Rate	0.54	



4. EXISTING CONDITIONS

4.1. EXISTING LAND USE

According to the Maricopa County Assessor, the proposed site is located on two (2) parcels, Assessor Parcel Number (APN) 215-44-002D and 215-44002F and consists of approximately 32.29 gross-acres. The existing site was previously occupied by CrackerJax. The site is currently zoned for General Commercial (C-4) land uses. This zoning is intended to provide space for the heaviest type of commercial activities found in the city. See [Appendix C](#) for detailed parcel information.

4.2. EXISTING TRAFFIC COUNTS

A local data collection firm, All Traffic Data, was utilized to collect traffic counts. On Tuesday, May 10, 2022, turning movement counts were obtained from 7:00 to 9:00 am and from 4:00 to 6:00 pm at the following locations:

- Scottsdale Road and Bell Road/Frank Lloyd Wright Boulevard (1)
- Scottsdale Road and Paradise Lane (2)
- Scottsdale Road and Driveway A (3)
- Scottsdale Road and Tierra Buena Lane (4)
- Scottsdale Road and Kierland Boulevard/Greenway Hayden Loop (5)
- Scottsdale Road and Greenway Parkway/Butherford Drive (6)
- Paradise Lane and Driveway C (8)
- Dial Boulevard and Paradise Lane (9)
- Dial Boulevard and Monte Cristo Avenue (11)
- Dial Boulevard and Driveway E (12)
- Tierra Buena Lane and Driveway F (13)
- Dial Boulevard and Tierra Buena Lane (14)
- Dial Boulevard/73rd Street and Greenway Hayden Loop (15)
- Frank Lloyd Wright Boulevard and 76th Street (16)
- Paradise Lane and 76th Street (17)
- Greenway Hayden Loop and Frank Lloyd Wright Boulevard (18)
- Greenway Hayden Loop and Paradise Lane (19)

Additionally, on Tuesday, May 10, 2022, bi-directional tube counts for 24-hours in 15-minute intervals were collected along the following roadway segments:

- Scottsdale Road, north of Paradise Lane
- Scottsdale Road, south of Paradise Lane
- Scottsdale Road, south of Tierra Buena Lane
- Paradise Lane, east of Scottsdale Road
- Dial Boulevard, south of Paradise Lane



- Tierra Buena Lane, east of Scottsdale Road

Similarly, on Tuesday, May 10, 2022, approach counts for 24-hours in 15-minute intervals were collected along the following intersections:

- Scottsdale Road and Tierra Buena Lane (all four approaches)
- Greenway Hayden Loop and Paradise Lane (all four approaches)

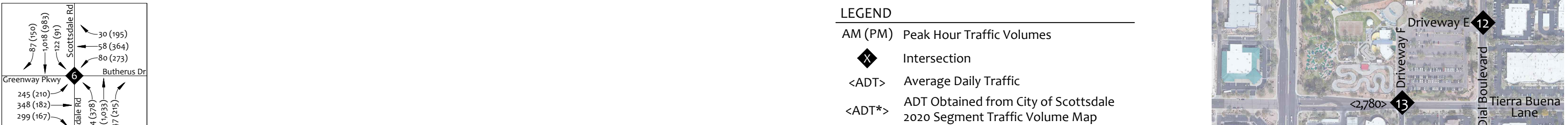
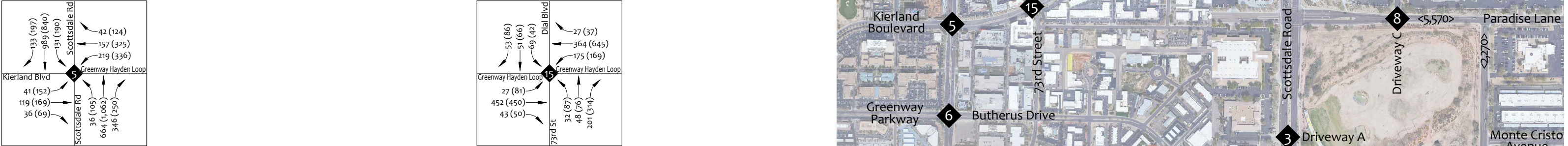
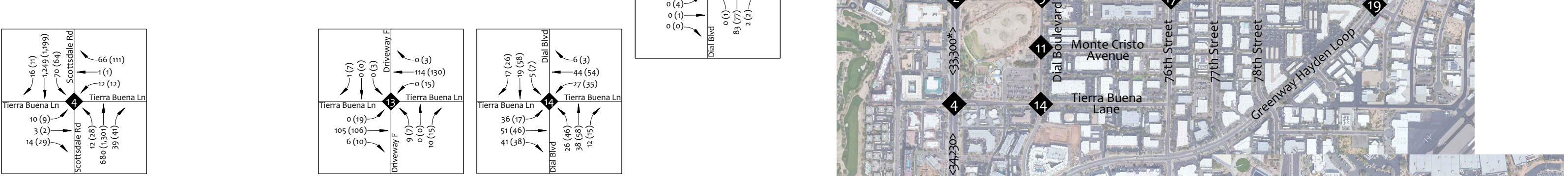
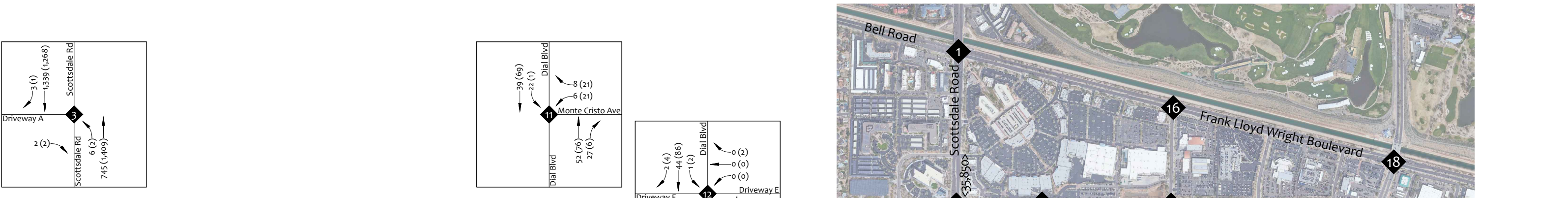
The turning movement counts were then analyzed for the highest 1-hour within each time period. The following peak hours were analyzed throughout this study.

AM Peak Hour	7:45 am – 8:45 am
PM Peak Hour	4:30 pm – 5:30 pm

The City of Scottsdale’s citywide seasonal adjustment factors were used to adjust the traffic counts. The traffic volumes were adjusted based on the month the counts were taken.

The recorded turning movement counts indicate that some u-turns movements were performed at study intersections. These u-turn volumes were added to the respective left turn movement volumes for the purposes of this study.

See [Appendix D](#) for detailed count data. See [Figure 4](#) for the existing adjusted AM and PM peak hour weekday traffic volumes.



LEGEND

- AM (PM) Peak Hour Traffic Volumes
- ◆ Intersection
- <ADT> Average Daily Traffic
- <ADT*> ADT Obtained from City of Scottsdale 2020 Segment Traffic Volume Map

FIGURE 4 | EXISTING TRAFFIC VOLUMES



4.3. EXISTING CAPACITY ANALYSIS

The existing conditions capacity analysis was completed for the existing study intersections. The capacity and level of service for the study area intersections were evaluated using the methodology presented in the 6th Edition of the Highway Capacity Manual (HCM). Traffic analysis software, Synchro Version 11, was used to perform the analyses using the signal timing provided by the City of Scottsdale. The existing peak hour factor (PHF) was used. However, if the existing PHF was greater than 0.92, the PHF was defaulted to 0.92. See **Appendix E** for the existing signal timing.

Table 3 is from the 6th Edition of the Highway Capacity Manual Exhibit 20-2, which lists the Level of Service (LOS) thresholds for signalized and unsignalized intersections.

Table 3 – Level of Service Criteria

Level of Service (LOS)	Control Delay per Vehicle (s/veh)	
	Signalized Intersection	Unsignalized Intersection
A	≤ 10	≤ 10
B	> 10-20	> 10-15
C	> 20-35	> 15-25
D	> 35-55	> 25-35
E	> 55-80	> 35-50
F	> 80	> 50

The results of the capacity analysis reveal the following locations with an existing level of service (LOS) E or F:

Scottsdale Road and Bell Road/Frank Lloyd Wright Boulevard (1)

- Eastbound left PM peak hour operates at LOS F
- Westbound left AM and PM peak hours operate at LOS E
- Westbound through PM peak hour operates at LOS E
- Northbound left AM and PM peak hours operate at LOS E
- Northbound through AM and PM peak hours operate at LOS E

Scottsdale Road and Paradise Lane (2)

- Overall intersection AM and PM peak hours operate at LOS E
- Eastbound left PM peak hour operates at LOS E
- Northbound through AM and PM peak hours operate at LOS E
- Southbound through AM and PM peak hours operate at LOS E



Scottsdale Road and Tierra Buena Lane (4)

- Westbound through AM peak hour operates at LOS F

Scottsdale Road and Kierland Boulevard/Greenway Hayden Loop (5)

- Eastbound left PM peak hour operates at LOS E
- Eastbound through AM and PM peak hours operate at LOS E
- Westbound left AM and PM peak hours operate at LOS E
- Westbound through AM and PM peak hours operate at LOS E
- Westbound shared through-right AM and PM peak hours operate at LOS E

Scottsdale Road and Greenway Parkway/Butherus Drive (6)

- Eastbound left PM peak hour operates at LOS E
- Westbound left AM peak hour operates at LOS E
- Southbound left AM and PM peak hours operate at LOS E

Dial Boulevard/73rd Street and Greenway Hayden Loop (15)

- Overall intersection AM and PM peak hours operate at LOS E
- Eastbound through AM and PM peak hours operate at LOS E
- Eastbound shared through-right AM and PM peak hours operate at LOS E
- Westbound through AM peak hour operates at LOS E

Greenway Hayden Loop and Frank Lloyd Wright Boulevard (18)

- Overall intersection AM and PM peak hours operate at LOS E
- Eastbound left PM peak hour operates at LOS E
- Eastbound through PM peak hour operates at LOS E
- Northbound left AM peak hour operates at LOS E
- Northbound through AM and PM peak hours operate at LOS E
- Southbound left AM and PM peak hours operate at LOS F and E, respectively
- Southbound through AM and PM peak hours operate at LOS F and E, respectively

Greenway Hayden Loop and Paradise Lane (19)

- Eastbound shared left-through PM peak hour operates at LOS E
- Westbound shared left-through PM peak hour operates at LOS E

The existing AM and PM peak hour level of service and delay for unsignalized intersections are shown in **Table 4** and signalized intersections are shown in **Table 5**.

See **Figure 5** for the existing AM and PM peak hour capacity analysis. The detailed capacity analysis sheets can be found in **Appendix F**.



Table 4 – Existing Level of Service and Delay – Unsignalized

Intersection	Existing Conditions			
	AM PEAK		PM PEAK	
Unsignalized Intersections	LOS	DELAY	LOS	DELAY
Scottsdale Road and Driveway A (3)				
Eastbound Right	B	10.9	B	10.7
Northbound Left	A	9.7	A	9.5
Scottsdale Road and Tierra Buena Lane (4)				
Eastbound Left	D	26.9	C	18.7
Eastbound Shared Through-Right	C	19.3	B	12.4
Westbound Left	C	15.5	C	16.7
Westbound Through	F	52.4	D	29.7
Westbound Right	B	10.2	B	12.0
Northbound Left	A	9.6	A	9.7
Southbound Left	A	9.2	B	10.5
Paradise Lane and Driveway C (8)				
Eastbound Left	A	7.5	A	7.8
Southbound Left	A	9.6	B	11.0
Dial Boulevard and Paradise Lane (9)				
Westbound Left	A	7.7	A	7.6
Northbound Left	B	10.3	B	11.2
Northbound Right	A	9.1	A	8.9
Dial Boulevard and Monte Cristo Avenue (11)				
Westbound Left	A	9.7	A	9.6
Westbound Right	A	8.7	A	8.8
Southbound Left	A	7.5	A	7.4
Dial Boulevard and Driveway E (12)				
Eastbound Shared Left-Through-Right	A	0.0	A	9.8
Westbound Shared Left-Through-Right	A	0.0	A	8.7
Northbound Left	A	0.0	A	7.4
Southbound Left	A	7.4	A	7.4
Tierra Buena Lane and Driveway F (13)				
Eastbound Left	A	0.0	A	7.5
Westbound Left	A	0.0	A	7.5
Northbound Shared Left-Through-Right	A	9.9	A	9.7
Southbound Shared Left-Through-Right	A	9.0	A	9.7
Dial Boulevard and Tierra Buena Lane (14)				
Eastbound Left	A	8.9	A	8.7
Eastbound Shared Through-Right	A	8.7	A	8.5
Westbound Left	A	8.9	A	9.0
Westbound Shared Through-Right	A	8.5	A	8.6
Northbound Left	A	9.1	A	9.0
Northbound Shared Through-Right	A	8.6	A	8.5
Southbound Left	A	8.8	A	8.6
Southbound Shared Through-Right	A	8.3	A	8.6
Paradise Lane and 76th Street (17)				
Eastbound Left	A	9.4	A	10.0
Eastbound Shared Through-Right	B	10.1	A	8.9
Westbound Left	A	9.3	A	9.0
Westbound Shared Through-Right	A	9.2	B	10.1
Northbound Left	A	9.1	A	9.1
Northbound Shared Through-Right	A	9.6	B	10.4
Southbound Left	A	9.3	A	9.1
Southbound Shared Through-Right	B	10.6	A	9.5
Greenway Hayden Loop and Paradise Lane (19)				
Eastbound Shared Left-Through	D	29.4	E	36.8
Eastbound Right	B	10.2	A	9.8
Westbound Shared Left-Through	C	22.6	E	45.6
Westbound Right	B	10.6	B	13.7
Northbound Left	A	8.4	A	8.2
Southbound Left	A	9.2	B	11.2



Table 5 – Existing Level of Service and Delay – Signalized

Intersection	Existing Conditions			
	AM PEAK		PM PEAK	
	LOS	DELAY	LOS	DELAY
Signalized Intersections				
Scottsdale Road and Bell Road/Frank Lloyd Wright Boulevard (1)				
Overall Intersection	D	42.9	D	49.6
Eastbound Left	D	43.8	F	89.8
Eastbound Through	D	48.7	D	36.7
Eastbound Right	D	47.1	D	36.3
Westbound Left	E	60.1	E	59.5
Westbound Through	D	45.8	E	55.4
Westbound Right	B	18.0	D	40.6
Northbound Left	E	69.2	E	58.9
Northbound Through	E	63.4	E	63
Northbound Right	D	38.9	C	30.8
Southbound Left	C	29.7	D	43.7
Southbound Through	C	30.6	D	35.1
Southbound Shared Through-Right	C	33.2	D	38.4
Scottsdale Road and Paradise Lane (2)				
Overall Intersection	E	57.3	E	59.1
Eastbound Left	D	52.7	E	56.0
Eastbound Through	D	53.8	D	54.4
Eastbound Right	D	53.6	D	54.1
Westbound Left	D	52.4	D	49.1
Westbound Through	D	54.2	D	47.2
Westbound Right*	A	7.6	B	19.3
Northbound Left	C	30.3	C	31.0
Northbound Through	E	66.7	E	61.0
Northbound Right	D	50.6	D	39.5
Southbound Left	C	22.4	C	34.6
Southbound Through	E	57.8	E	59.6
Southbound Right	D	39.0	D	41.2
Scottsdale Road and Kierland Boulevard /Greenway Hayden Loop (5)				
Overall Intersection	D	47.2	D	40.4
Eastbound Left	D	52.0	E	56.8
Eastbound Through	E	56.5	E	55.3
Eastbound Right	B	12.6	B	14.4
Westbound Left	E	67.6	E	69.8
Westbound Through	E	58.0	E	55.9
Westbound Shared Through-Right	E	59.4	E	57.5
Northbound Left	A	6.0	A	8.7
Northbound Through	C	34.6	D	35.1
Northbound Right	D	112.8	B	19.4
Southbound Left	A	3.2	B	13.1
Southbound Through	D	36.1	D	39.8
Southbound Right	C	27.0	D	38.6

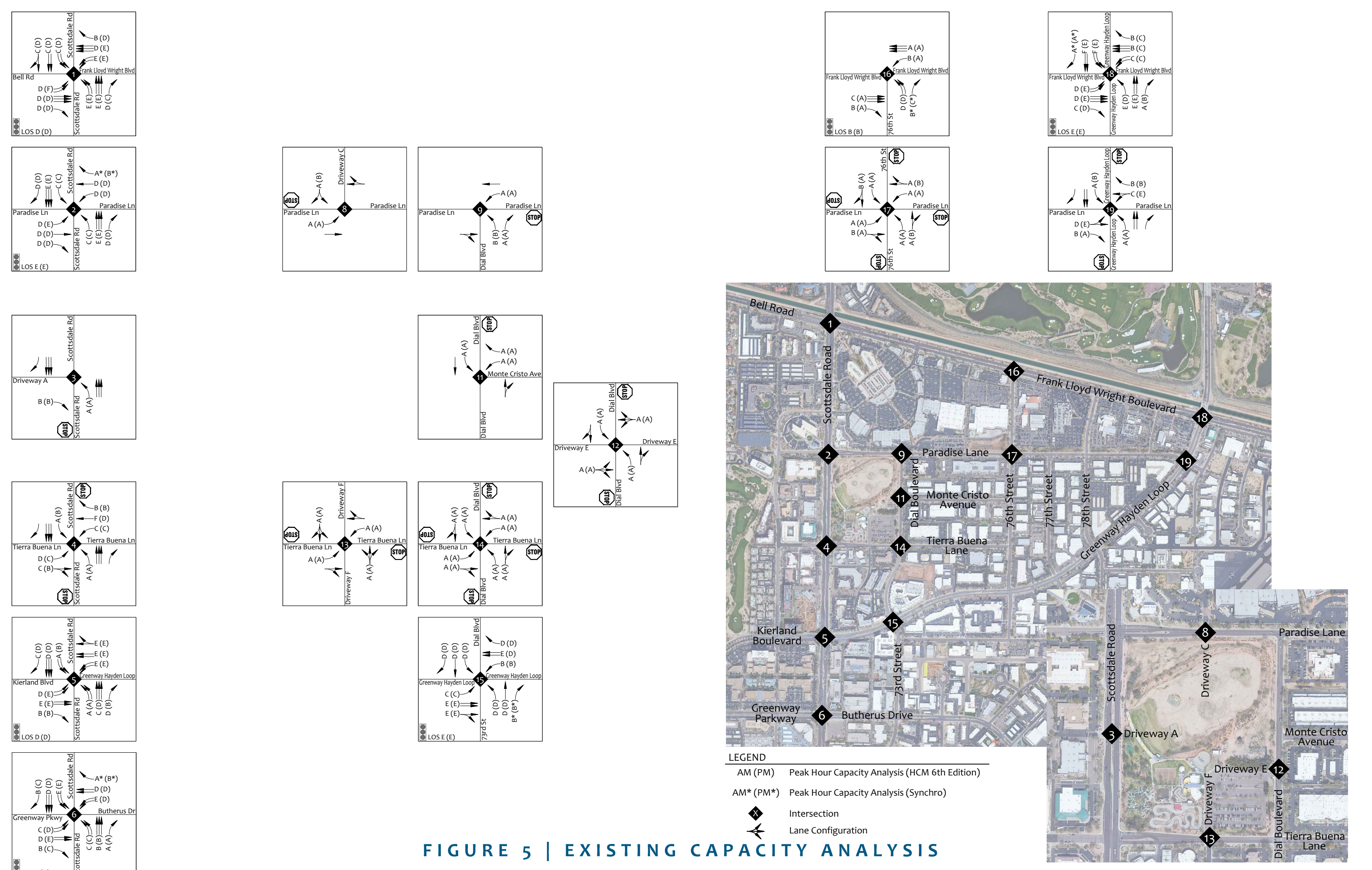
*Synchro Level of Service Reported



Table 5 – Existing Level of Service and Delay – Signalized – Continued

Intersection	Existing Conditions			
	AM PEAK		PM PEAK	
	LOS	DELAY	LOS	DELAY
Signalized Intersections				
Scottsdale Road and Greenway Parkway/Butherus Drive (6)				
Overall Intersection	C	33.9	D	36.3
Eastbound Left	D	47.7	E	62.2
Eastbound Through	D	52.9	D	54.1
Eastbound Right	B	16.6	C	20.6
Westbound Left	E	58.8	D	52.4
Westbound Through	D	54.5	D	51.0
Westbound Right*	A	0.6	B	14.0
Northbound Left	C	26.5	C	29.7
Northbound Through	B	14.8	B	17.0
Northbound Right	A	5.3	A	6.2
Southbound Left	E	69.3	E	58.5
Southbound Through	D	35.3	D	36.8
Southbound Right	B	15.3	C	21.5
Dial Boulevard/73rd St and Greenway Hayden Loop (15)				
Overall Intersection	E	55.4	E	78.5
Eastbound Left	C	20.0	C	22.9
Eastbound Through	E	63.1	E	60.0
Eastbound Shared Through-Right	E	70.8	E	67.7
Westbound Left	B	11.7	B	11.9
Westbound Through	E	61.2	D	52.3
Westbound Right	D	45.4	D	35.2
Northbound Left	D	46.2	D	50.2
Northbound Through	D	43.3	D	44.1
Northbound Right*	B	11.5	B	13.3
Southbound Left	D	48.5	D	48.9
Southbound Through	D	43.4	D	43.8
Southbound Right	D	43.8	D	45.0
Frank Lloyd Wright Boulevard and 76th Street (16)				
Overall Intersection	B	17.5	B	13.1
Eastbound Through	C	24.3	A	0.3
Eastbound Right	B	15.2	A	0.2
Westbound Left	B	13.2	A	5.7
Westbound Through	A	0.1	A	0.2
Northbound Left	D	50.1	D	43.6
Northbound Right*	B	19.8	C	33.9
Greenway Hayden Loop and Frank Lloyd Wright Boulevard (18)				
Overall Intersection	E	57.3	E	59.0
Eastbound Left	D	49.1	E	65.5
Eastbound Through	D	39.8	E	58.7
Eastbound Right	C	24.3	D	41.1
Westbound Left	C	26.4	C	33.4
Westbound Through	B	16.3	C	25.2
Westbound Right	B	15.0	C	25.5
Northbound Left	E	56.8	D	51.8
Northbound Through	E	56.1	E	57.8
Northbound Right	A	7.7	B	17.0
Southbound Left	F	193.0	E	62.2
Southbound Through	F	153.1	E	56.0
Southbound Right*	A	9.6	A	9.5

*Synchro Level of Service Reported





5. PROJECTED TRAFFIC

5.1. TRIP GENERATION

The trip generation for the proposed development was calculated utilizing the Institute of Transportation Engineers (ITE) publication entitled *Trip Generation, 11th Edition*. The ITE rates are based on studies that measured the trip generation characteristics for various types of land uses. The rates are expressed in terms of trips per unit of land use type. This publication is considered to be the standard for the transportation engineering profession.

Proposed Development

The trip generation for the proposed development was calculated utilizing the following ITE Land Uses:

- ITE Land Use 221 – Multifamily Housing (Mid-Rise)
- ITE Land Use 310 – Hotel
- ITE Land Use 710 – General Office Building
- ITE Land Use 822 – Strip Retail Plaza (<40K SF)
- ITE Land Use 931 – Quality Restaurant

Pass-By Trips

Pass-by trips are intermediate stops on the way from an origin to a primary trip destination without a route diversion. Pass-by trips are attracted from the existing traffic passing the site on an adjacent street or roadway that offers direct access to the generator. These trips are not considered new trips generated by the proposed development. Pass-by rates were applied to the trips generated by the proposed retail/restaurant space located on site. The rates are based on data provided in the *ITE Trip Generation Handbook, 3rd Edition*. See **Appendix G** for detailed pass-by rates.

Internal Capture

Given the mixed-use nature of the proposed development which includes residential, retail, restaurant, and office land uses, it is anticipated that some of the trips will be internal, i.e. beginning and ending within the development. Based on the NCHRP Report 684 – Enhancing Internal Trip Capture Estimation of Mixed-Use Developments, the internal capture rates for trip origins and trip destinations within a multi-use development were applied for weekday AM and PM hours.

Trip generation calculations are shown in **Table 6** below. Detailed trip generation calculations are provided in **Appendix G**.



Table 6 – Trip Generation – Proposed Development

Land Use	ITE Code	Qty	Unit	Weekday	AM Peak Hour			PM Peak Hour		
				Total	Total	In	Out	Total	In	Out
Multifamily Housing (Mid-Rise)	221	1,236	Dwelling Units	5,849	532	122	410	482	294	188
Hotel	310	223	Rooms	1,994	105	59	46	138	70	68
General Office Building	710	150.000	1000 SF GFA	1,651	237	209	28	232	39	193
Strip Retail Plaza (<40k)	822	25.250	1000 SF GLA	1,375	60	36	24	166	83	83
Quality Restaurant	931	35.120	1000 SF GFA	2,944	26	14	12	274	184	90
Total				13,813	960	440	520	1,292	670	622
Pass-By				1,291	-	-	-	177	109	68
Internal Capture				2,002	100	50	50	240	120	120
Total				10,520	860	390	470	875	441	434

5.2. TRIP GENERATION COMPARISON

Existing Zoning

Currently the proposed site is comprised of two (2) parcels zoned for C-4 land uses with a maximum floor area ratio (FAR) of 0.8 for commercial uses. The following mix of land uses were assumed for build out under the existing C-4 zoning:

- 27,700 square feet Automobile Sales
- 44,720 square feet Automobile Care Center
- 130,370 square feet Furniture Store
- 208,770 square feet Free-Standing Store
- 151,910 square feet Free-Standing Store
- 395,000 square feet General Light Industrial

The trip generation for the existing zoning was obtained from the La Via Traffic Impact & Mitigation Analysis, dated September 13, 2018. See [Table 7](#).



Table 7 – Trip Generation Comparison – Existing Zoning

Land Use	Weekday	AM Peak Hour			PM Peak Hour		
	Total	Total	In	Out	Total	In	Out
Existing Zoning (La Via Traffic Impact & Mitigation Analysis, Dated September 13, 2018)	22,899	1,131	746	385	2,085	908	117
Proposed Development (The Parque)	10,520	860	390	470	875	441	434
Total	-12,379	-271	-356	85	-1,210	-467	317

The Parque is anticipated to generate 12,379 fewer weekday daily trips, with 271 and 1,210 fewer trips during the AM and PM peak hours, respectively, versus the existing zoning.

5.3. TRIP DISTRIBUTION AND ASSIGNMENT

The trip distribution procedure determines the general pattern of travel for vehicles entering and leaving the proposed development. The trip distribution for the proposed development is based on the distribution of the existing traffic. This project is being developed in a primarily developed area, so it can be assumed that the existing trip distribution will remain. The trip distribution is shown in **Figure 6**.

The trip assignment was generally based on proximity of the driveways, permitted turn movements, as well as ease and probability of use. The site generated traffic volumes are shown in **Figure 7**.

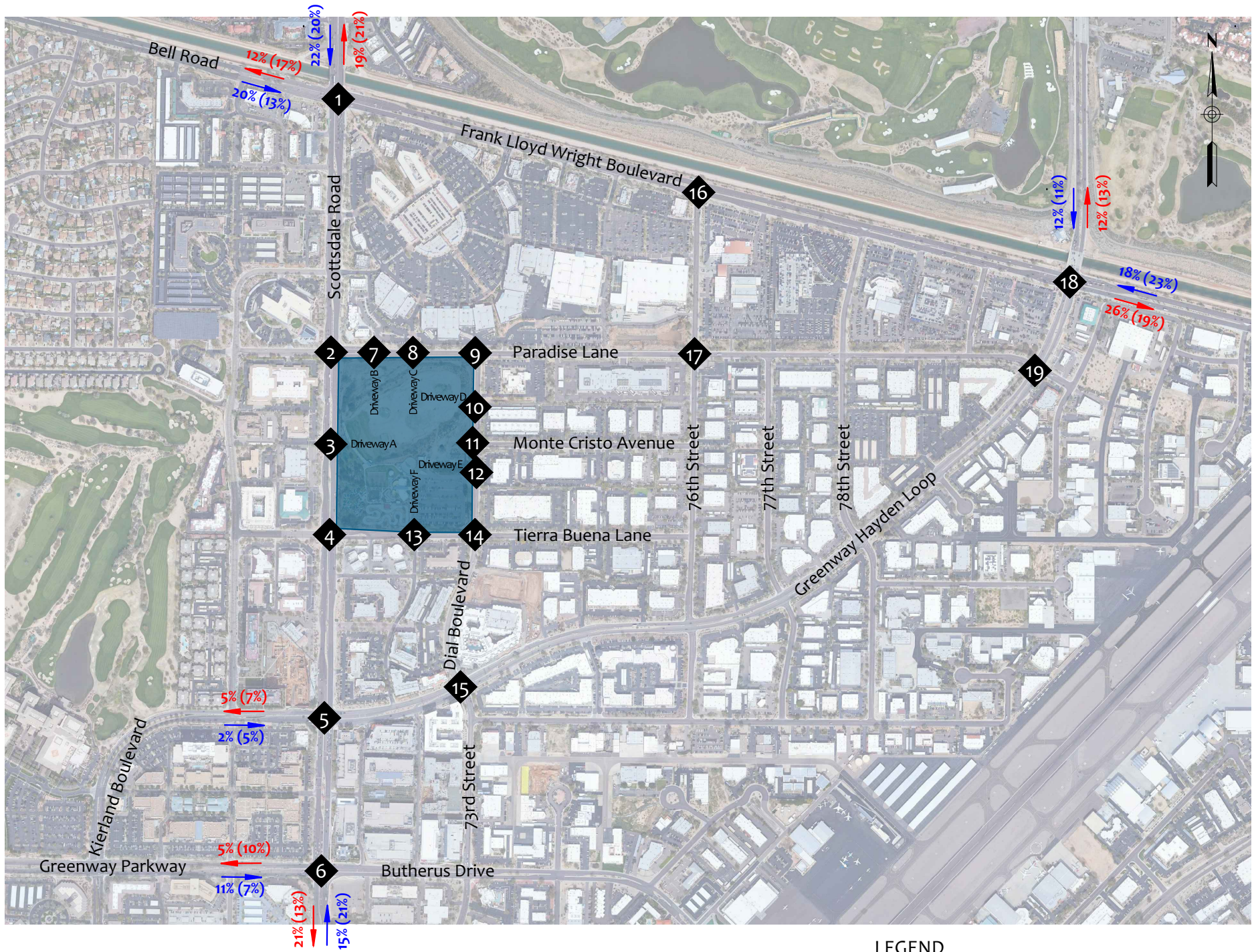
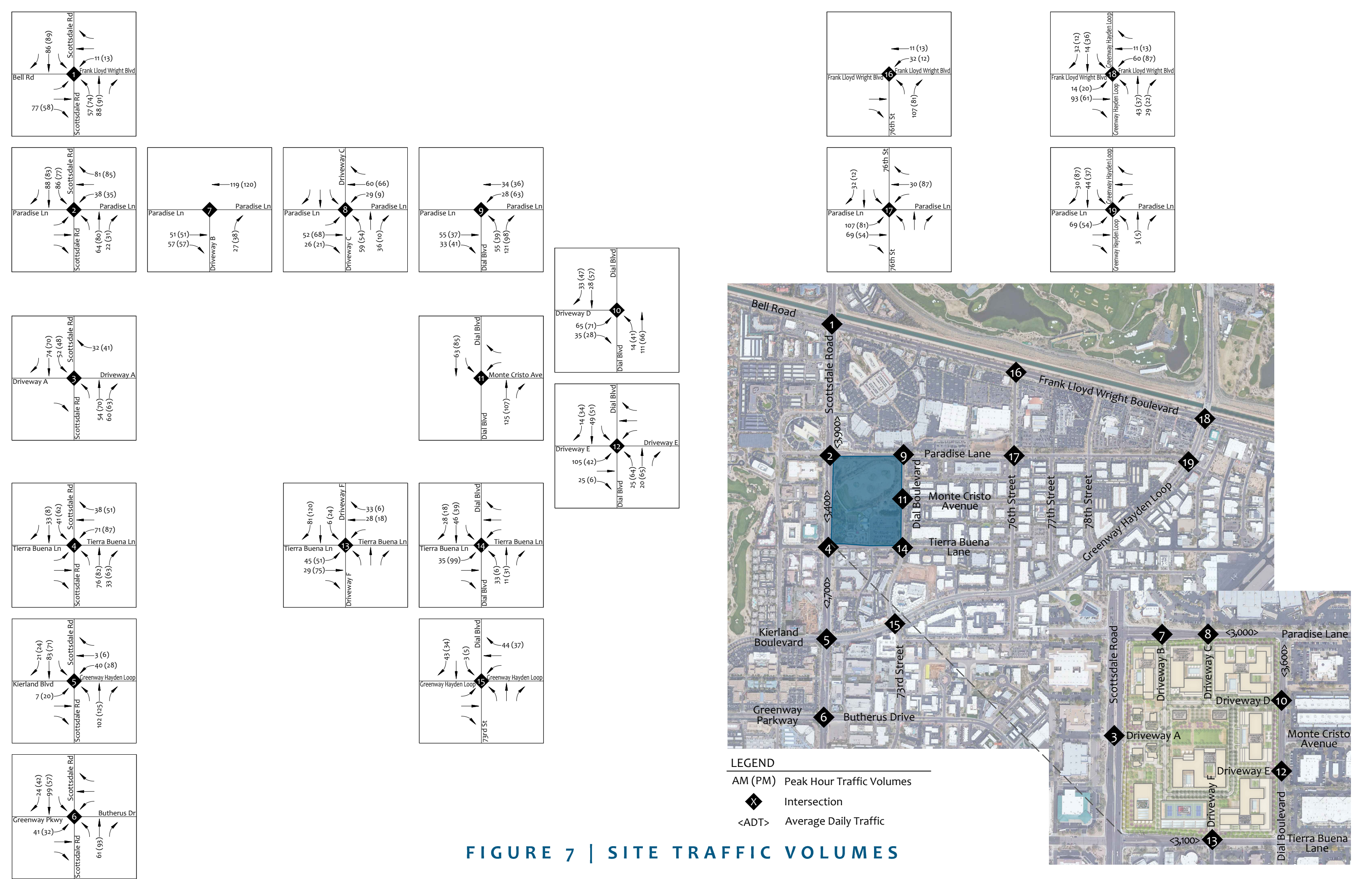
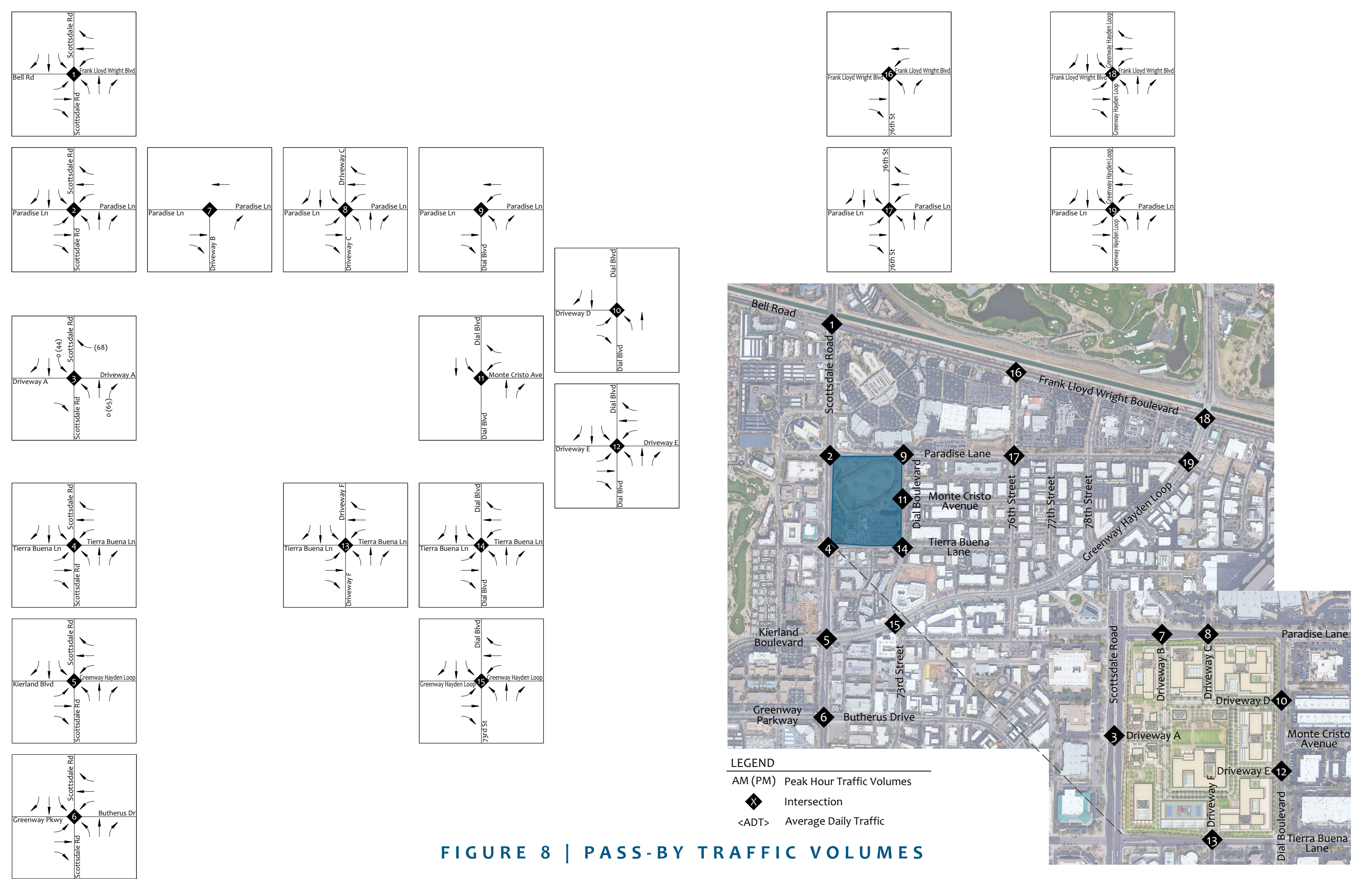


FIGURE 6 | TRIP DISTRIBUTION







6. FUTURE CONDITIONS (YEAR 2025)

The opening of the proposed development is anticipated to occur during the year 2025. Therefore, this section analyzes the effects the proposed development will have on the surrounding roadway network during the opening year of 2025.

6.1. YEAR 2025 NO BUILD TRAFFIC VOLUMES

At the direction of City of Scottsdale Transportation Staff, a 2% annual growth rate was to be utilized. However, as a conservative approach to account for surrounding developments, a 2.5% annual growth rate was utilized. See **Figure 9** for the year 2025 no build traffic volumes which includes a 2.5% annual growth rate applied to the existing traffic volumes (**Figure 4**).

At the time of this study, the existing development located at the site, CrackerJax, is closed. Therefore, the volumes entering and exiting the existing site driveways were removed as a conservative approach.

6.2. YEAR 2025 BUILD TRAFFIC VOLUMES

When the site traffic (**Figure 7**) and pass-by traffic (**Figure 8**) are added to the year 2025 no build traffic (**Figure 9**), the result is the 2025 build traffic volumes. This represents the traffic volumes with the build out of the proposed development. The year 2025 build traffic volumes are shown in **Figure 10**.

6.3. YEAR 2025 NO BUILD CAPACITY ANALYSIS

The capacity and level of service for the study area intersections were evaluated for the 2025 no build scenario. The PHF was assumed to be 0.92. Traffic signal timing was optimized and adjusted for future traffic operations.

The year 2025 no build AM and PM peak hour level of service and delay for unsignalized intersections are shown in **Table 8** and signalized intersections are shown in **Table 9**.

The results of the year 2025 no build capacity analysis are shown in **Figure 11**. The results of the capacity analysis reveal the following locations with a level of service (LOS) E or F:

Scottsdale Road and Bell Road/Frank Lloyd Wright Boulevard (1)

- Eastbound left PM peak hour operates at LOS F
- Westbound left AM and PM peak hours operate at LOS E
- Westbound through PM peak hour operates at LOS E
- Northbound left AM and PM peak hours operate at LOS E
- Northbound through AM and PM peak hours operate at LOS E



Scottsdale Road and Paradise Lane (2)

- Overall intersection AM and PM peak hours operate at LOS E
- Eastbound left PM peak hour operates at LOS E
- Northbound through AM and PM peak hours operate at LOS E
- Southbound through AM and PM peak hours operate at LOS E

Scottsdale Road and Tierra Buena Lane (4)

- Eastbound left AM peak hour operates at LOS E
- Westbound through AM peak hour operates at LOS F

Scottsdale Road and Kierland Boulevard/Greenway Hayden Loop (5)

- Eastbound left PM peak hour operates at LOS E
- Eastbound through AM and PM peak hours operate at LOS E
- Westbound left AM and PM peak hours operate at LOS E
- Westbound through AM and PM peak hours operate at LOS E
- Westbound shared through-right AM and PM peak hours operate at LOS E
- Northbound right AM peak hour operates at LOS F

Scottsdale Road and Greenway Parkway/Butherus Drive (6)

- Eastbound left PM peak hour operates at LOS E
- Westbound left AM peak hour operates at LOS E
- Southbound left PM peak hour operates at LOS E

Dial Boulevard/73rd Street and Greenway Hayden Loop (15)

- Overall intersection AM peak hour operates at LOS E
- Eastbound through AM and PM peak hours operate at LOS E
- Eastbound shared through-right AM and PM peak hours operate at LOS E
- Westbound through AM peak hour operates at LOS E

Greenway Hayden Loop and Frank Lloyd Wright Boulevard (18)

- Overall intersection PM peak hour operates at LOS E
- Eastbound left PM peak hour operates at LOS E
- Eastbound through PM peak hour operates at LOS E
- Northbound left AM peak hour operates at LOS E
- Northbound through AM and PM peak hours operate at LOS E
- Southbound left AM and PM peak hours operate at LOS E
- Southbound through PM peak hour operates at LOS E



Greenway Hayden Loop and Paradise Lane (19)

- Eastbound shared left-through AM and PM peak hours operate at LOS E
- Westbound shared left-through PM peak hour operates at LOS F

The detailed capacity analysis sheets can be found in **Appendix I**.

6.4. YEAR 2025 BUILD CAPACITY ANALYSIS

The capacity and level of service for the study area intersections were evaluated for the year 2025 **build** traffic volumes. The PHF was assumed to be 0.92. Traffic signal timing was optimized and adjusted for future traffic operations.

Additionally, as part of the proposed development, the following improvements are assumed:

Scottsdale Road and Driveway A (3)

- Build out of a three-quarter access driveway, allowing right-in, left-in, and right-out movements. Improvements include installation of northbound right turn deceleration lane and a southbound left turn lane.

Scottsdale Road and Tierra Buena Lane (4)

- Installation of a traffic signal (See **Section 9** for traffic signal warrant). A 120-second cycle length is assumed for the traffic signal timing operations.

Paradise Lane and Driveway B (7)

- Build out of a right-in and right-out driveway.

Paradise Lane and Driveway C (8)

- Build out of a full access driveway on the south leg of the existing intersection.

Dial Boulevard and Driveway E (12)

- Modification to the existing intersection on the west leg to accommodate the site driveway.

Tierra Buena Lane and Driveway F (13)

- Modification to the existing intersection on the north leg to accommodate the site driveway.

The year 2025 **build** AM and PM peak hour level of service and delay for unsignalized intersections are shown in **Table 8** and signalized intersections are shown in **Table 9**.



The results of the year 2025 build capacity analysis are shown in **Figure 12**. All movements operate at a LOS D or better or are maintained at the year 2025 no build level of service, with the exception of:

Scottsdale Road and Bell Road/Frank Lloyd Wright Boulevard (1)

- Overall intersection PM peak hour operates at LOS E

Scottsdale Road and Tierra Buena Lane (4)

- Eastbound shared through-right PM peak hour operates at LOS E

Scottsdale Road and Kierland Boulevard/Greenway Hayden Loop (5)

- Southbound through PM peak hour operates at LOS E
- Southbound right AM peak hour operates at LOS E

Greenway Hayden Loop and Paradise Lane (19)

- Eastbound shared left-through AM and PM peak hours operate at LOS F

The detailed capacity analysis sheets can be found in **Appendix J**.



Table 8 – Year 2025 Level of Service and Delay – Unsignalized

Intersection	Year 2025 No Build				Year 2025 Build			
	AM PEAK		PM PEAK		AM PEAK		PM PEAK	
Unsignalized Intersections	LOS	DELAY	LOS	DELAY	LOS	DELAY	LOS	DELAY
Scottsdale Road and Driveway A (3)								
Eastbound Right	B	11.1	B	10.9	B	11.4	B	11.1
Westbound Right	-	-	-	-	B	10.3	B	13.0
Northbound Left	A	9.9	A	9.7	B	10.1	A	9.9
Southbound Left	-	-	-	-	A	9.4	B	11.9
Scottsdale Road and Tierra Buena Lane (4)								
Overall Intersection	-	-	-	-	D	37.4	D	36.9
Eastbound Left	E	35.2	C	22.6	D	52.6	D	52.7
Eastbound Shared Through-Right	C	23.6	B	12.7	D	54.3	E	55.4
Westbound Left	C	18.5	C	19.6	D	53.4	D	50.4
Westbound Through	F	74.3	D	30.7	D	49.6	D	45.0
Westbound Right*	B	10.3	B	12.9	B	16.9	B	14.7
Northbound Left	A	9.8	A	9.9	A	6.6	B	18.2
Northbound Through	-	-	-	-	D	40.5	D	35.4
Northbound Right	-	-	-	-	C	30.8	C	22.5
Southbound Left*	A	9.6	B	10.4	A	7.4	B	15.0
Southbound Through	-	-	-	-	D	36.7	D	38.6
Southbound Right	-	-	-	-	B	16.2	B	17.9
Paradise Lane and Driveway B (7)								
Northbound Right	-	-	-	-	B	10.3	A	9.8
Paradise Lane and Driveway C (8)								
Eastbound Left	A	7.5	A	7.9	A	7.7	A	8.1
Westbound Left	-	-	-	-	A	7.8	A	7.6
Northbound Shared Left-Through-Right	-	-	-	-	B	13.4	C	19.2
Southbound Left	A	9.5	B	11.3	-	-	-	-
Southbound Shared Left-Through-Right	-	-	-	-	B	11.0	B	13.3
Dial Boulevard and Paradise Lane (9)								
Westbound Left	A	7.6	A	7.6	A	7.9	A	8.0
Northbound Left	B	10.2	B	11.3	B	11.9	B	14.6
Northbound Right	A	9.0	A	9.0	B	10.1	A	9.9
Dial Boulevard and Driveway D (10)								
Eastbound Shared Left-Right	-	-	-	-	B	10.6	B	11.7
Northbound Left	-	-	-	-	A	7.5	A	7.8
Dial Boulevard and Monte Cristo Avenue (11)								
Westbound Left	A	9.6	A	9.7	B	10.5	B	10.6
Westbound Right	A	8.7	A	8.8	A	9.4	A	9.5
Southbound Left	A	7.4	A	7.4	A	7.7	A	7.7
Dial Boulevard and Driveway E (12)								
Eastbound Shared Left-Through-Right	A	0.0	A	0.0	B	11.5	B	13.0
Westbound Shared Left-Through-Right	A	0.0	A	8.7	B	0.0	A	9.1
Northbound Left	A	0.0	A	0.0	A	7.5	A	7.7
Southbound Left	A	7.4	A	7.4	A	7.5	A	7.5
Tierra Buena Lane and Driveway G (13)								
Eastbound Left	-	-	-	-	A	7.7	A	7.7
Westbound Left	A	0.0	A	7.5	A	0.0	A	7.6
Northbound Shared Left-Through-Right	A	9.7	A	9.7	B	10.9	B	11.2
Southbound Shared Left-Through-Right	-	-	-	-	A	9.9	B	11.0
Dial Boulevard and Tierra Buena Lane (14)								
Eastbound Left	A	8.6	A	8.7	A	9.5	B	10.6
Eastbound Shared Through-Right	A	8.1	A	8.5	A	8.6	A	9.0
Westbound Left	A	8.5	A	8.9	A	9.0	A	9.5
Westbound Shared Through-Right	A	8.1	A	8.6	A	8.6	A	9.2
Northbound Left	A	8.7	A	9.0	A	9.4	A	9.6
Northbound Shared Through-Right	A	8.2	A	8.5	A	8.6	A	9.6
Southbound Left	A	8.5	A	8.6	A	8.7	A	9.0
Southbound Shared Through-Right	A	7.9	A	8.6	A	9.0	A	10.0
Paradise Lane and 76th Street (17)								
Eastbound Left	A	8.9	A	9.8	B	10.9	B	12.0
Eastbound Shared Through-Right	A	9.0	A	8.7	B	10.7	A	10.0
Westbound Left	A	8.9	A	8.9	A	9.4	A	9.3
Westbound Shared Through-Right	A	8.5	A	9.8	A	9.6	B	12.9
Northbound Left	A	8.7	A	9.0	A	9.5	A	9.9
Northbound Shared Through-Right	A	8.8	B	10.1	A	9.8	B	11.7
Southbound Left	A	8.8	A	9.0	A	9.6	A	9.9
Southbound Shared Through-Right	A	9.3	A	9.3	B	10.9	B	10.7
Greenway Hayden Loop and Paradise Lane (19)								
Eastbound Shared Left-Through	E	40.3	E	47.8	F	56.4	F	94.9
Eastbound Right	B	10.4	B	10.0	B	10.6	B	10.2
Westbound Shared Left-Through	D	29.0	F	64.1	D	30.8	F	66.1
Westbound Right	B	10.9	B	14.5	B	10.9	B	14.6
Northbound Left	A	8.7	A	8.3	A	8.9	A	8.8
Southbound Left	A	9.5	B	11.7	A	9.5	B	11.8

*Synchro Level of Service Reported



Table 9 – Year 2025 Level of Service and Delay – Signalized

Intersection	2025 No Build				2025 Build			
	AM PEAK		PM PEAK		AM PEAK		PM PEAK	
	LOS	DELAY	LOS	DELAY	LOS	DELAY	LOS	DELAY
Signalized Intersections								
Scottsdale Road and Bell Road/Frank Lloyd Wright Boulevard (1)								
Overall Intersection	D	43.4	D	53.6	D	47.1	E	56.9
Eastbound Left	D	43.4	F	110.2	D	40.1	F	110.2
Eastbound Through	D	48.8	D	36.2	D	42	D	37.3
Eastbound Right	D	47.1	D	35.8	D	54.7	D	39.7
Westbound Left	E	55.5	E	59.4	D	52.7	E	65.2
Westbound Through	D	45.3	E	56.1	D	44.9	E	57.8
Westbound Right	B	18.6	D	47.6	C	21.8	D	52.6
Northbound Left	E	59.4	E	60.1	E	64.7	E	72.1
Northbound Through	E	63.1	E	66.7	E	62.4	E	66.8
Northbound Right	D	38.3	C	30.1	D	35.3	C	28
Southbound Left	C	31.1	D	48.4	D	35.7	D	50.8
Southbound Through	C	33.2	D	40.5	D	45.7	D	47.0
Southbound Shared Through-Right	D	36.5	D	45.7	D	53.2	D	54.8
Scottsdale Road and Paradise Lane (2)								
Overall Intersection	E	56.6	E	57.6	D	50.6	D	45.5
Eastbound Left	D	52.9	E	56.4	D	53.9	E	56.5
Eastbound Through	D	53.8	D	54.5	D	53.8	D	54.5
Eastbound Right	D	53.6	D	54.2	D	53.6	D	54.2
Westbound Left	D	52.6	D	48.5	D	49.1	D	42.8
Westbound Through	D	54.3	D	46.3	D	47.9	D	40.3
Westbound Right*	A	8.5	B	19.2	B	19.4	B	18.5
Northbound Left	C	31.4	C	32.9	B	13.5	B	16.3
Northbound Through	E	66.3	E	60.3	D	51.2	C	33.9
Northbound Right	D	50.1	D	38	C	34.6	B	14.3
Southbound Left	C	23.0	D	36.8	C	28.3	D	41.8
Southbound Through	E	56.6	E	57.6	D	54.3	E	56.8
Southbound Right	D	37.9	D	39.8	D	36.5	D	38.6
Scottsdale Road and Kierland Boulevard /Greenway Hayden Loop (5)								
Overall Intersection	D	48.9	D	40.2	D	40.2	D	44.4
Eastbound Left	D	51.7	E	56.7	D	50.3	E	56.0
Eastbound Through	E	56.5	E	55.3	E	56.8	E	55.3
Eastbound Right	B	13.5	B	15.1	C	26.3	B	17.9
Westbound Left	E	69.3	E	70.9	E	58.2	E	70.9
Westbound Through	E	57.9	E	55.8	E	57.9	E	55.9
Westbound Shared Through-Right	E	59.4	E	57.4	E	59.3	E	57.4
Northbound Left	A	7.5	A	9.7	D	38.1	B	14.2
Northbound Through	C	34.6	C	34.5	D	49.4	C	28.8
Northbound Right	F	129.3	B	18.5	F	124.7	B	13.0
Southbound Left	A	3.9	B	14.3	A	5.4	D	41.9
Southbound Through	C	34.7	D	39.1	A	5.8	E	55.9
Southbound Right	C	25.4	D	37.8	A	5.3	E	55.0

*Synchro Level of Service Reported



Table 9 – Year 2025 Level of Service and Delay – Signalized – Continued

Intersection	2025 No Build				2025 No Build			
	AM PEAK		PM PEAK		AM PEAK		PM PEAK	
	LOS	DELAY	LOS	DELAY	LOS	DELAY	LOS	DELAY
Signalized Intersections								
Scottsdale Road and Greenway Parkway/Butherus Drive (6)								
Overall Intersection	C	33.2	D	36.3	C	32.5	D	36.6
Eastbound Left	D	46.6	E	63.8	D	47.8	E	60.6
Eastbound Through	D	53.7	D	53.5	D	53.7	D	53.5
Eastbound Right	B	18.2	C	22.3	B	19.7	C	23.4
Westbound Left	E	60.1	D	52.4	E	60.1	D	50.7
Westbound Through	D	54.6	D	50.0	D	54.6	D	50.1
Westbound Right*	A	0.7	B	15.3	A	0.7	B	15.3
Northbound Left	C	29.1	C	32.5	C	31	C	34.0
Northbound Through	B	16.5	B	18.6	B	16.7	C	20
Northbound Right*	A	7.6	A	7.7	A	7.7	B	11.8
Southbound Left	D	54	E	59.6	D	54	E	59.1
Southbound Through	C	33.1	D	35.5	C	30.5	D	36.4
Southbound Right	B	13.4	B	19.8	B	11.9	B	19.3
Dial Boulevard/73rd St and Greenway Hayden Loop (15)								
Overall Intersection	E	55.4	D	51	E	55.0	D	50.6
Eastbound Left	C	20.0	C	33.7	C	20.1	C	33.7
Eastbound Through	E	63.1	E	62.5	E	63.1	E	62.6
Eastbound Shared Through-Right	E	70.7	E	69.9	E	70.7	E	70.2
Westbound Left	B	11.7	B	17.2	B	11.7	B	17.2
Westbound Through	E	61.2	D	52.2	E	61.0	D	52.1
Westbound Right	D	45.4	D	35	D	49.3	D	36.6
Northbound Left	D	46.2	D	40.4	D	46.3	D	40.5
Northbound Through	D	43.3	D	35.6	D	43.3	D	35.5
Northbound Right*	B	14.4	B	13.1	B	14.2	B	13.1
Southbound Left	D	48.7	D	39.4	D	48.8	D	39.7
Southbound Through	D	43.4	D	35.3	D	43.4	D	35.3
Southbound Right	D	43.8	D	36.2	D	45.4	D	37.2
Frank Lloyd Wright Boulevard and 76th Street (16)								
Overall Intersection	B	17.5	A	6.9	C	22.5	A	8.1
Eastbound Through	C	24.3	A	0.4	C	30.2	A	0.5
Eastbound Right	B	15.3	A	0.2	C	20.4	A	0.3
Westbound Left	B	13.3	A	7.6	C	25.7	A	10.7
Westbound Through	A	0.1	A	0.3	A	0.1	A	0.4
Northbound Left	D	50.0	D	39	D	42.2	D	33.7
Northbound Right*	B	19.8	D	36.7	D	35.6	D	42.8
Greenway Hayden Loop and Frank Lloyd Wright Boulevard (18)								
Overall Intersection	D	37	E	62	D	40.4	E	52.7
Eastbound Left	D	51.8	E	67.1	D	52.3	E	70.7
Eastbound Through	D	44.9	E	57.9	D	51.6	E	57.3
Eastbound Right	C	24.7	D	39.7	C	23.5	D	38.8
Westbound Left	C	29.4	D	37.3	C	32.2	D	42.1
Westbound Through	B	19.1	C	28.5	C	20.4	C	30.3
Westbound Right	B	17.5	C	29	B	18.7	C	30.7
Northbound Left	E	62	D	51.4	E	58.9	D	51.6
Northbound Through	E	59.1	E	59.3	E	61.6	E	61.3
Northbound Right	A	8.3	C	30.4	A	9.2	D	46.5
Southbound Left	E	55.6	E	61.4	E	55.6	E	58.7
Southbound Through	D	54.1	E	57.2	D	54.3	E	56.2
Southbound Right*	A	7.2	B	10.7	A	7.0	B	13.4

*Synchro Level of Service Reported

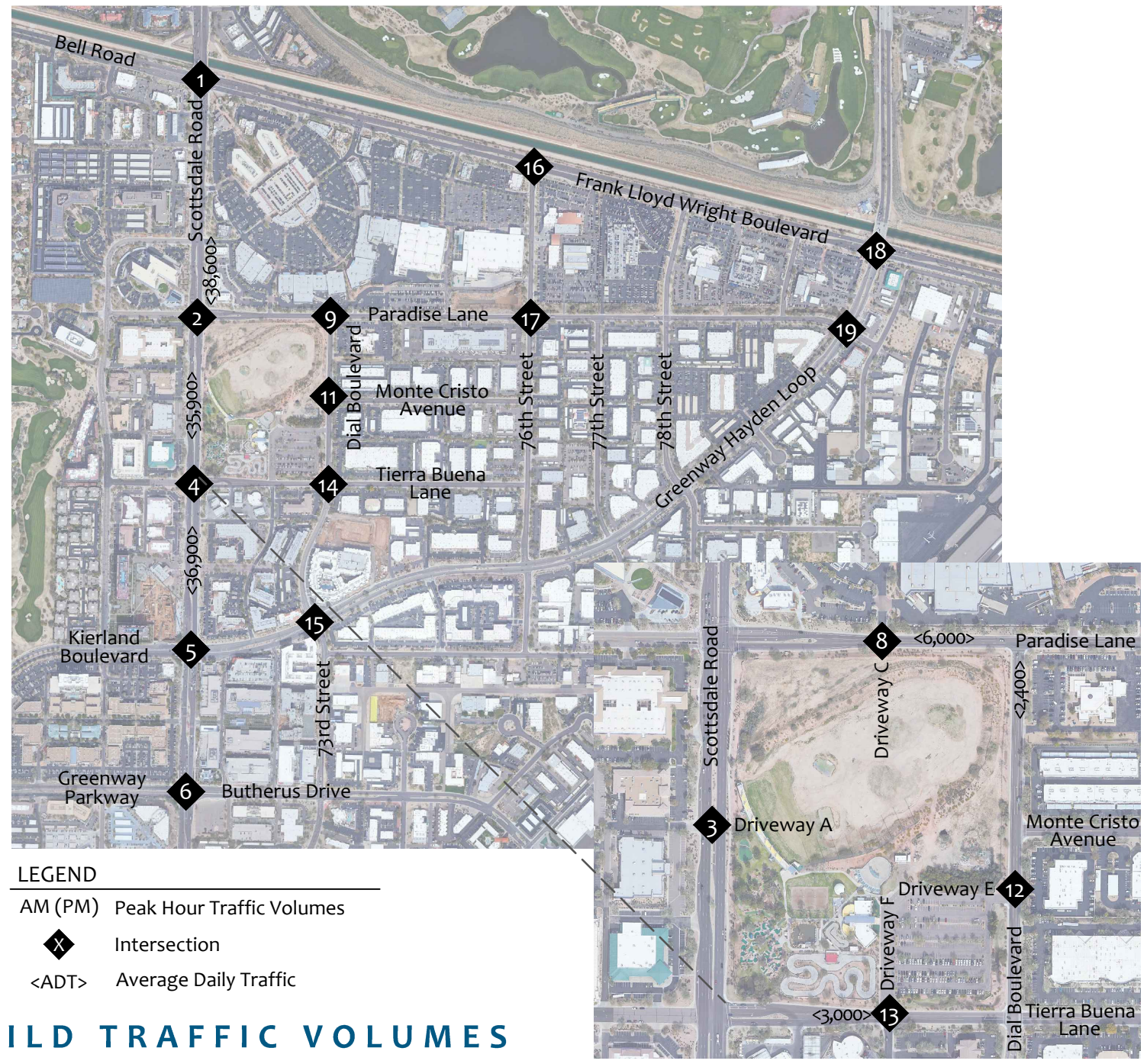
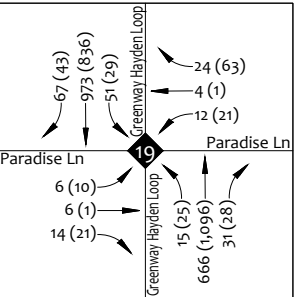
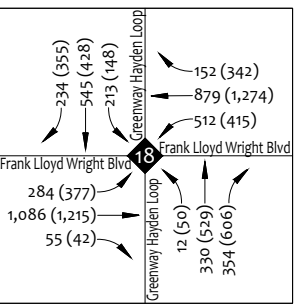
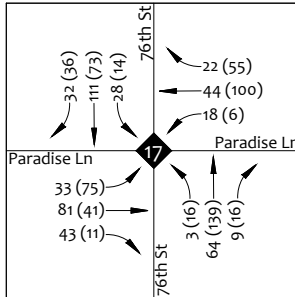
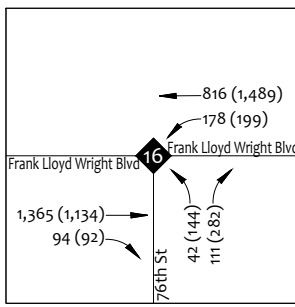
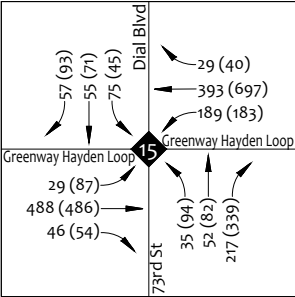
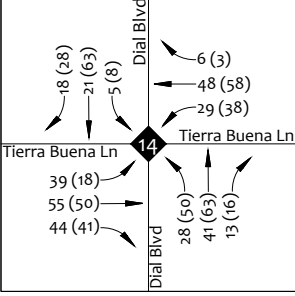
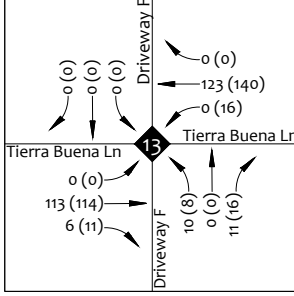
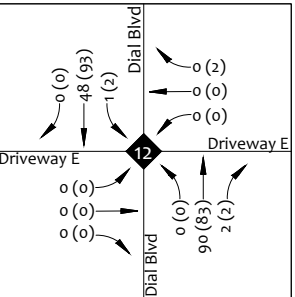
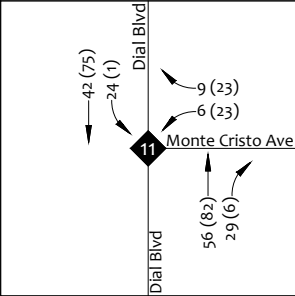
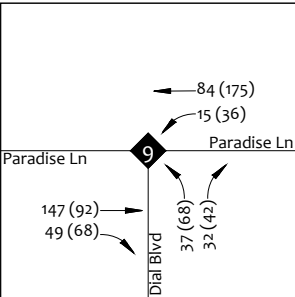
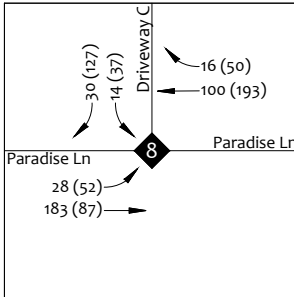
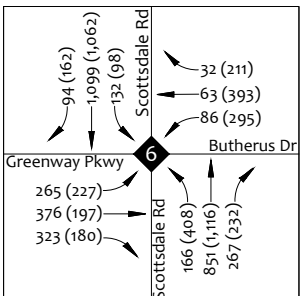
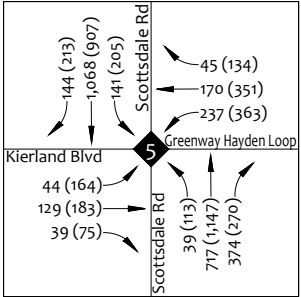
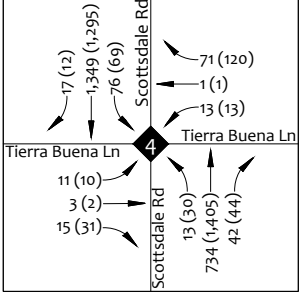
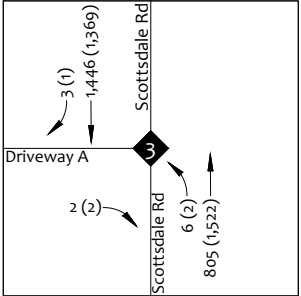
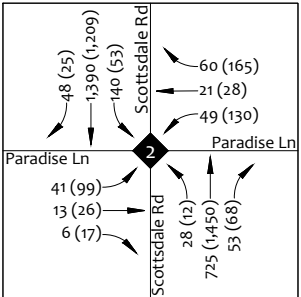
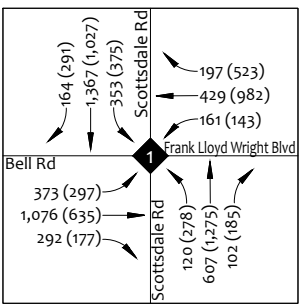
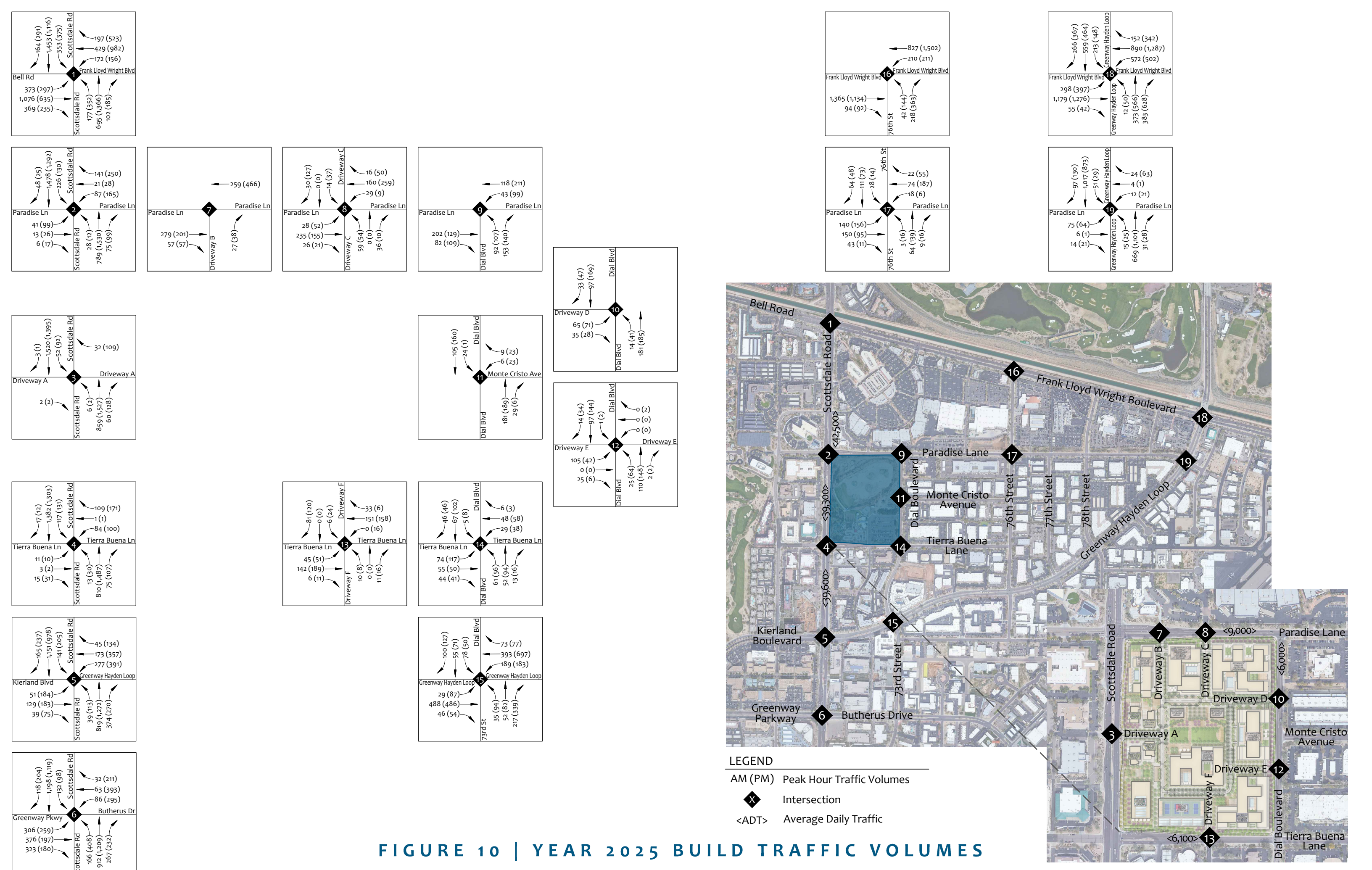
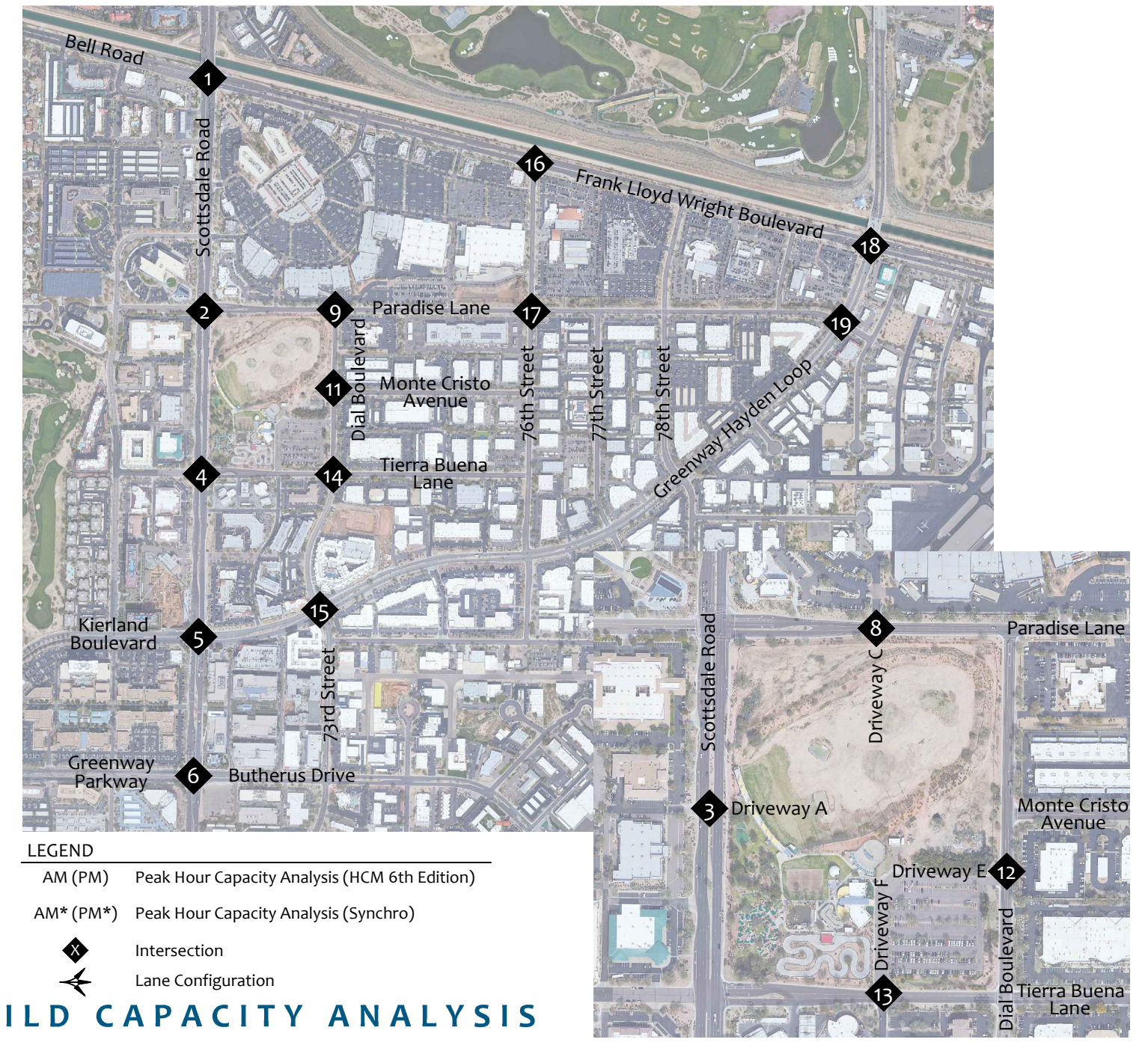
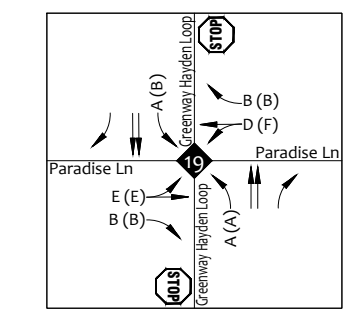
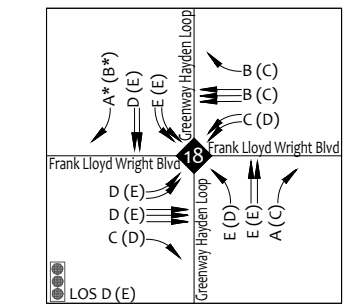
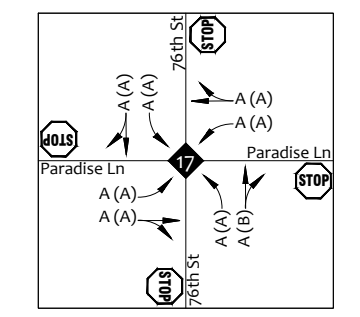
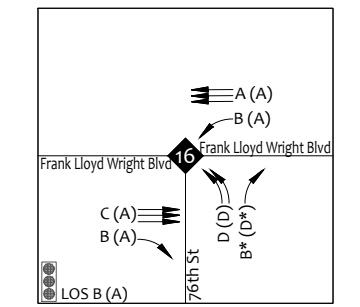
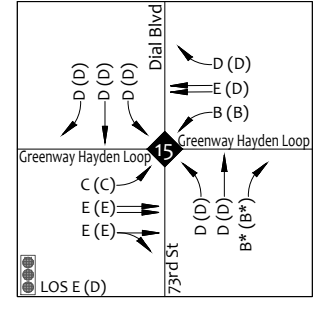
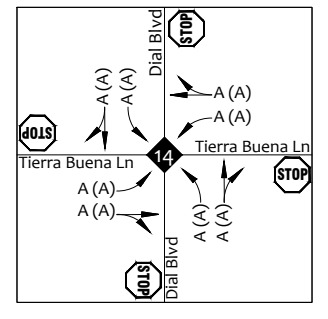
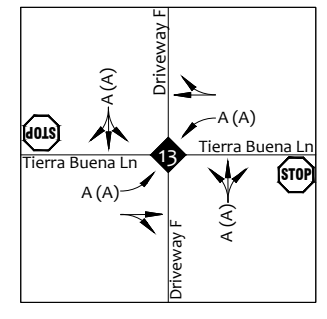
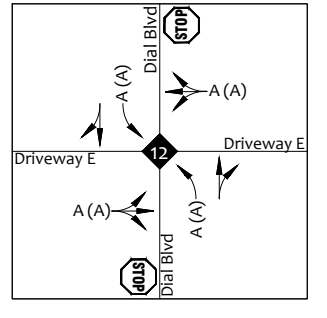
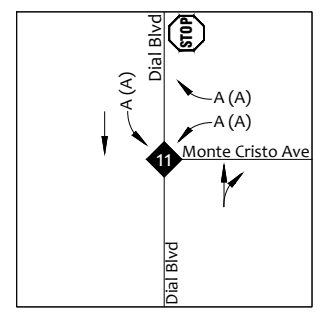
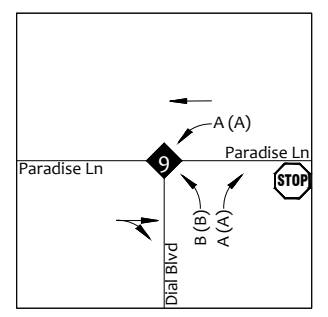
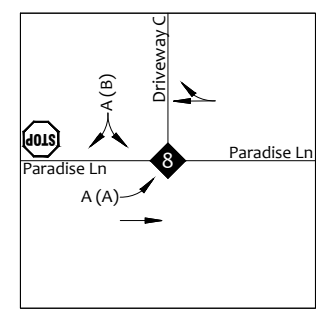
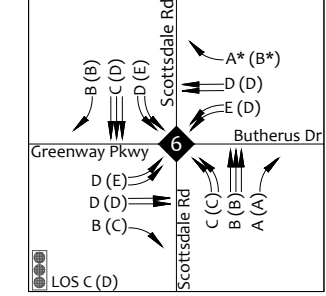
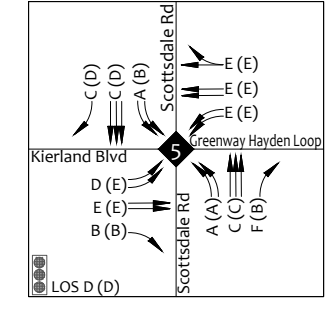
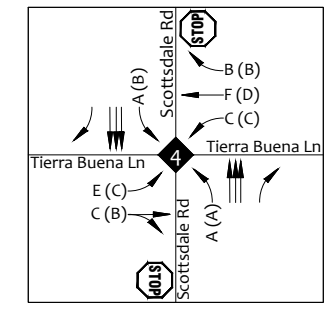
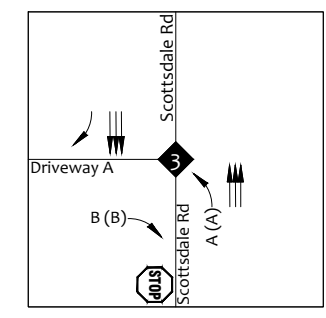
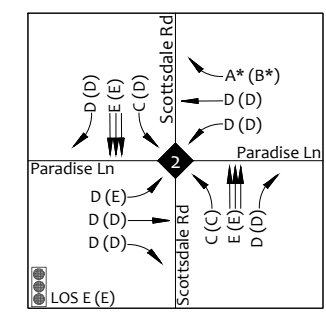
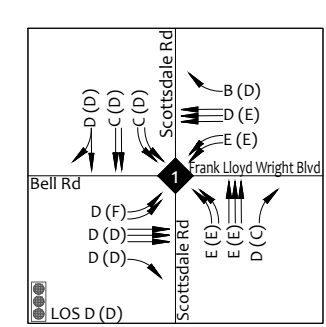
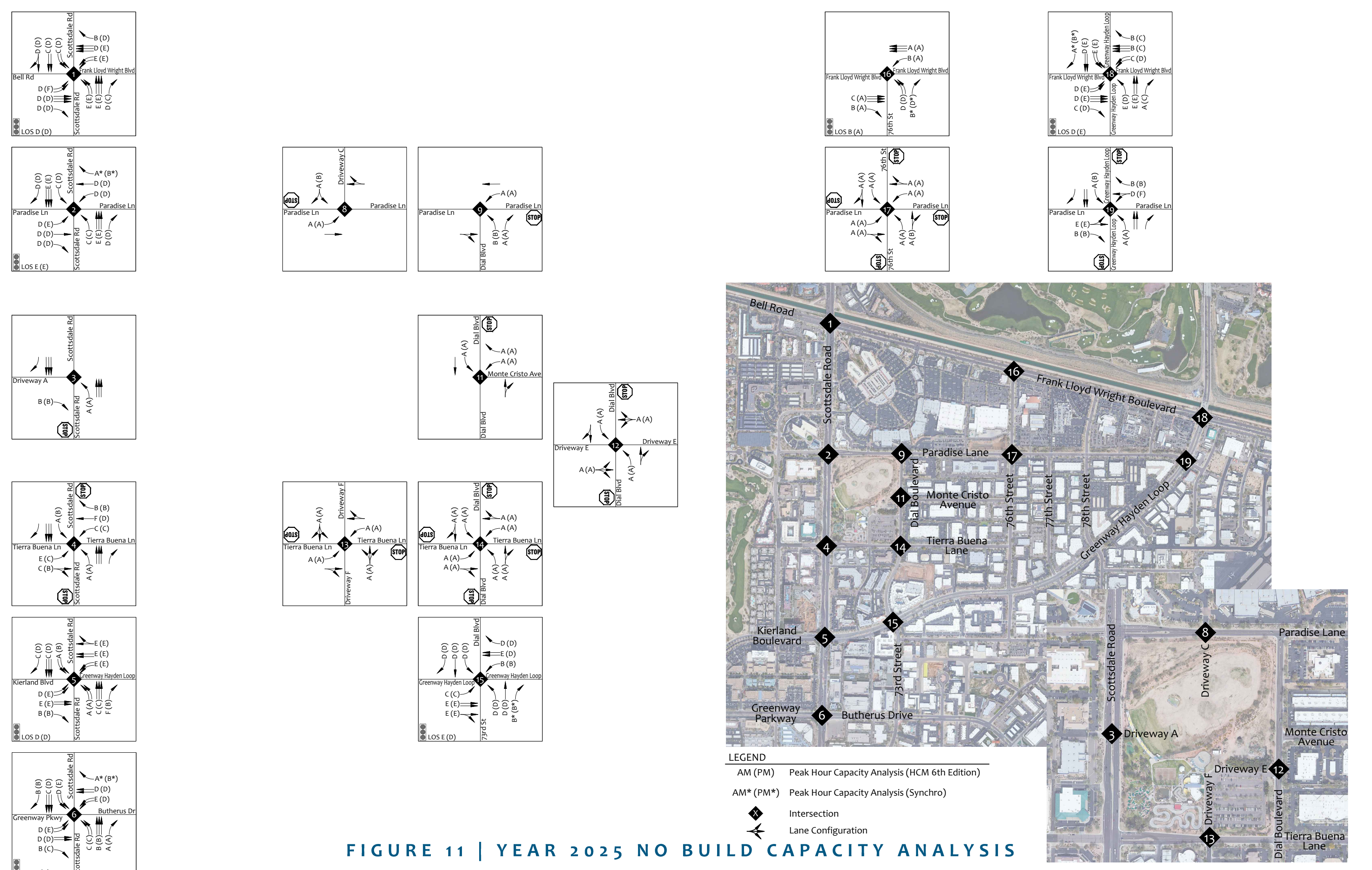
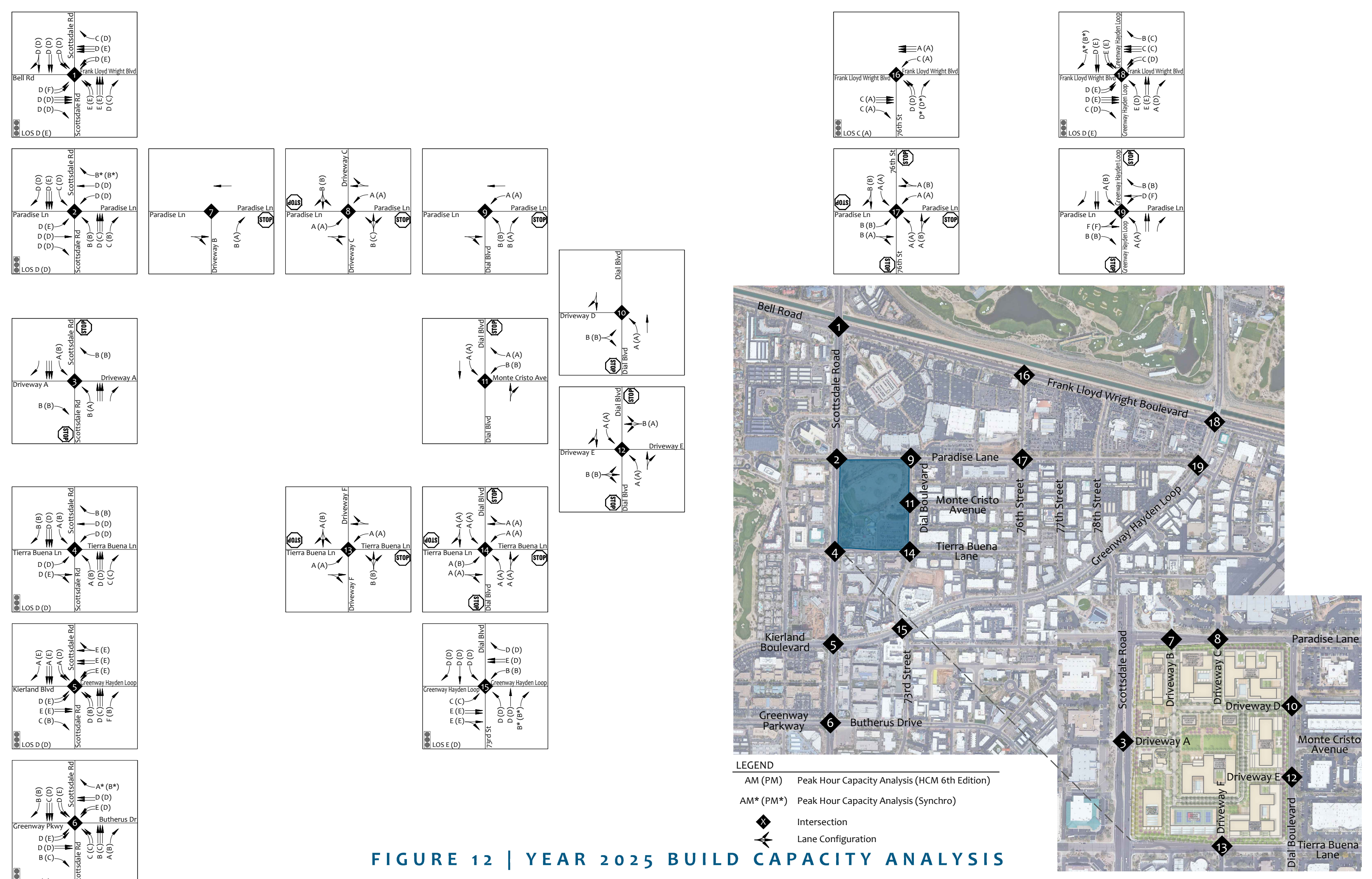


FIGURE 9 | YEAR 2025 NO BUILD TRAFFIC VOLUMES









7. FUTURE CONDITIONS (YEAR 2030)

This section analyzes the effects the proposed development will have on the surrounding roadway network during the year of 2030, 5 years after the opening year.

7.1. YEAR 2030 BACKGROUND TRAFFIC VOLUMES

Similar to the year 2025 background traffic volumes described in detail in **Section 6.1**, a 2.5% annual growth rate was applied to the existing traffic volumes through the year 2030. The year 2030 no build traffic volumes are shown in **Figure 13**.

7.2. YEAR 2030 BUILD TRAFFIC VOLUMES

When the site traffic (**Figure 7**) and pass-by traffic volumes (**Figure 8**) are added to the year 2030 no build traffic (**Figure 13**), the result is the 2030 build traffic volumes. This represents the traffic volumes with the build out of the proposed development. The year 2030 build traffic volumes are shown in **Figure 14**.

7.3. YEAR 2030 NO BUILD CAPACITY ANALYSIS

The capacity and level of service for the study area intersections were evaluated for the year 2030 no build scenario. The PHF was assumed to be 0.92. Traffic signal timing was optimized and adjusted for future traffic operations.

The year 2030 no build AM and PM peak hour level of service and delay for unsignalized intersections are shown in **Table 10** and signalized intersections are shown in **Table 11**.

The results of the year 2030 no build capacity analysis are shown in **Figure 15**. The results of the capacity analysis reveal the following locations with a level of service (LOS) E or F:

Scottsdale Road and Bell Road/Frank Lloyd Wright Boulevard (1)

- Overall intersection PM peak hour operates at LOS E
- Eastbound left PM peak hour operates at LOS F
- Westbound left AM and PM peak hours operate at LOS E
- Westbound through PM peak hour operates at LOS E
- Westbound right PM peak hour operates at LOS E
- Northbound left AM and PM peak hours operate at LOS E
- Northbound through AM and PM peak hours operate at LOS E and F, respectively
- Southbound left PM peak hour operates at LOS E

Scottsdale Road and Paradise Lane (2)

- Overall intersection PM peak hour operates at LOS E



- Eastbound left PM peak hour operates at LOS E
- Northbound through AM and PM peak hours operate at LOS E
- Southbound through PM peak hour operates at LOS E

Scottsdale Road and Tierra Buena Lane (4)

- Eastbound left AM peak hour operates at LOS F
- Westbound through AM peak hour operates at LOS E

Scottsdale Road and Kierland Boulevard/Greenway Hayden Loop (5)

- Eastbound through AM peak hour operates at LOS E
- Westbound left AM and PM peak hours operate at LOS E
- Westbound through AM and PM peak hours operate at LOS E
- Westbound shared through-right AM and PM peak hours operate at LOS E
- Northbound right AM peak hour operates at LOS F

Scottsdale Road and Greenway Parkway/Butherus Drive (6)

- Eastbound through AM peak hour operates at LOS E
- Westbound left AM peak hour operates at LOS E

Dial Boulevard/73rd Street and Greenway Hayden Loop (15)

- Eastbound through AM and PM peak hours operate at LOS E
- Eastbound shared through-right AM and PM peak hours operate at LOS E
- Westbound through AM peak hour operates at LOS E

Greenway Hayden Loop and Frank Lloyd Wright Boulevard (18)

- Overall intersection PM peak hour operates at LOS E
- Eastbound left PM peak hour operates at LOS E
- Eastbound through PM peak hour operates at LOS E
- Northbound left AM peak hour operates at LOS E
- Northbound right PM peak hour operates at LOS F
- Southbound left AM and PM peak hours operate at LOS E and F, respectively

Greenway Hayden Loop and Paradise Lane (19)

- Eastbound shared left-through AM and PM peak hours operate at LOS F
- Westbound shared left-through AM and PM peak hour operates at LOS E and F, respectively

The detailed capacity analysis sheets can be found in [Appendix K](#).



7.4. YEAR 2030 BUILD CAPACITY ANALYSIS

The year 2030 build capacity analysis was completed for the study intersections and driveways during the AM and PM peak hour. The PHF was assumed to be 0.92. Traffic signal timing was optimized and adjusted for future traffic operations.

The improvements identified in [Section 6.4](#) are assumed for the year 2030 build scenario.

The year 2030 build AM and PM peak hour level of service and delay for unsignalized intersections are shown in [Table 10](#) and signalized intersections are shown in [Table 11](#).

The results of the 2030 build capacity analysis level of service are shown in [Figure 16](#). All movements operate at a LOS D or better or are maintained at the year 2030 no build level of service, with the exception of:

Scottsdale Road and Bell Road/Frank Lloyd Wright Boulevard (1)

- Eastbound right AM peak hour operates at LOS E

Scottsdale Road and Tierra Buena Lane (4)

- Eastbound shared through-right PM peak hour operates at LOS E

Greenway Hayden Loop and Frank Lloyd Wright Boulevard (18)

- Westbound left PM peak hour operates at LOS E

Greenway Hayden Loop and Paradise Lane (19)

- Westbound shared left-through AM peak hour operates at LOS F

The detailed capacity analysis sheets can be found in [Appendix L](#).



Table 10 – Year 2030 Level of Service and Delay – Unsignalized

Intersection	Year 2030 No Build				Year 2030 Build			
	AM PEAK		PM PEAK		AM PEAK		PM PEAK	
Unsignalized Intersections	LOS	DELAY	LOS	DELAY	LOS	DELAY	LOS	DELAY
Scottsdale Road and Driveway A (3)								
Eastbound Right	B	11.6	B	11.4	B	11.9	B	11.4
Westbound Right	-	-	-	-	B	10.4	B	13.9
Northbound Left	B	10.3	B	10.1	B	10.5	B	10.1
Southbound Left	-	-	-	-	A	9.6	B	12.7
Scottsdale Road and Tierra Buena Lane (4)								
Overall Intersection	-	-	-	-	C	34.4	D	38.5
Eastbound Left	F	54.2	D	33.1	D	52.6	D	52.6
Eastbound Shared Through-Right	E	41.2	B	14.6	D	54.4	E	55.7
Westbound Left	C	24.5	D	27.4	D	52.7	D	49.3
Westbound Through	F	129.5	E	48.4	D	48.9	D	44.0
Westbound Right*	B	10.5	B	14.0	B	17.2	B	14.9
Northbound Left	B	10.2	B	10.1	B	10.4	C	26.3
Northbound Through	-	-	-	-	D	37.9	D	41.2
Northbound Right	-	-	-	-	C	27.8	C	25.0
Southbound Left*	A	9.9	B	11.0	A	1.1	B	19.6
Southbound Through	-	-	-	-	C	32.8	D	35.0
Southbound Right	-	-	-	-	B	12.6	B	14.3
Paradise Lane and Driveway B (7)								
Northbound Right	-	-	-	-	B	10.8	B	10.1
Paradise Lane and Driveway C (8)								
Eastbound Left	A	7.6	A	8.0	A	7.7	A	8.2
Westbound Left	-	-	-	-	A	7.9	A	7.6
Northbound Shared Left-Through-Right	-	-	-	-	B	14.2	C	22.2
Southbound Left	A	9.7	B	11.9	-	-	-	-
Southbound Shared Left-Through-Right	-	-	-	-	B	11.4	B	14.5
Dial Boulevard and Paradise Lane (9)								
Westbound Left	A	7.7	A	9.1	A	8.0	A	8.0
Northbound Left	B	10.4	B	11.8	B	12.3	C	15.4
Northbound Right	A	9.1	A	7.7	B	10.4	A	9.9
Dial Boulevard and Driveway D (10)								
Eastbound Shared Left-Right	-	-	-	-	B	10.9	B	12.2
Northbound Left	-	-	-	-	A	7.6	A	7.9
Dial Boulevard and Monte Cristo Avenue (11)								
Westbound Left	A	9.7	A	9.8	B	10.6	B	10.8
Westbound Right	A	8.7	A	8.9	A	9.5	A	9.6
Southbound Left	A	7.5	A	7.4	A	7.8	A	7.7
Dial Boulevard and Driveway E (12)								
Eastbound Shared Left-Through-Right	A	0.0	A	0.0	B	11.7	B	13.4
Westbound Shared Left-Through-Right	A	0.0	A	8.8	A	0.0	A	9.2
Northbound Left	A	0.0	A	0.0	A	7.5	A	7.8
Southbound Left	A	7.4	A	7.4	A	7.5	A	7.6
Tierra Buena Lane and Driveway C (13)								
Eastbound Left	-	-	-	-	A	7.8	A	7.7
Westbound Left	A	0.0	A	7.6	A	0.0	A	7.7
Northbound Shared Left-Through-Right	A	9.9	A	9.9	B	11.2	B	11.5
Southbound Shared Left-Through-Right	-	-	-	-	B	10.1	B	11.3
Dial Boulevard and Tierra Buena Lane (14)								
Eastbound Left	A	8.7	A	8.9	A	9.6	B	10.9
Eastbound Shared Through-Right	A	8.4	A	8.8	A	8.9	A	9.3
Westbound Left	A	8.7	A	9.1	A	9.2	A	9.8
Westbound Shared Through-Right	A	8.3	A	8.8	A	8.8	A	9.5
Northbound Left	A	8.8	A	9.2	A	9.6	A	9.9
Northbound Shared Through-Right	A	8.3	A	8.8	A	8.8	A	10.0
Southbound Left	A	8.6	A	8.7	A	8.9	A	9.2
Southbound Shared Through-Right	A	8.1	A	8.9	A	9.2	B	10.5
Paradise Lane and 76th Street (17)								
Eastbound Left	A	9.1	B	10.3	B	11.3	B	12.8
Eastbound Shared Through-Right	A	9.4	A	9.1	B	11.4	B	10.5
Westbound Left	A	9.1	A	9.1	A	9.6	A	9.6
Westbound Shared Through-Right	A	8.8	B	10.6	B	10.1	B	14.3
Northbound Left	A	8.9	A	9.2	A	9.7	B	10.1
Northbound Shared Through-Right	A	9.1	B	10.8	B	10.2	B	12.7
Southbound Left	A	9.0	A	9.3	A	9.8	B	10.2
Southbound Shared Through-Right	A	9.8	A	9.8	B	11.7	B	11.4
Greenway Hayden Loop and Paradise Lane (19)								
Eastbound Shared Left-Through	F	69.0	F	82.6	F	159.3	F	313.7
Eastbound Right	B	10.8	B	10.5	B	11.1	B	10.5
Westbound Shared Left-Through	E	49.0	F	134.0	F	53.7	F	157.5
Westbound Right	B	11.4	C	16.2	B	11.4	C	16.3
Northbound Left	A	9.1	A	8.6	A	9.3	A	9.2
Southbound Left	B	10.0	B	12.9	B	10.0	B	12.9

*Synchro Level of Service Reported



Table 11 – Year 2030 Level of Service and Delay – Signalized

Intersection	2030 No Build				2030 Build			
	AM PEAK		PM PEAK		AM PEAK		PM PEAK	
	LOS	DELAY	LOS	DELAY	LOS	DELAY	LOS	DELAY
Signalized Intersections								
Scottsdale Road and Bell Road/Frank Lloyd Wright Boulevard (1)								
Overall Intersection	D	49.6	E	66	D	47.6	E	66.1
Eastbound Left	D	43.1	F	152.9	D	41	F	152.9
Eastbound Through	D	53.2	D	38.4	D	49.8	D	37.5
Eastbound Right	D	50.5	D	37.8	E	78.4	D	40.8
Westbound Left	E	76.4	E	68.7	E	66.1	E	74.9
Westbound Through	D	47.8	E	71.9	D	46.8	E	65.5
Westbound Right	C	20.5	E	74.4	B	17.1	D	48.0
Northbound Left	E	61.4	E	78.5	E	70.5	E	74.0
Northbound Through	E	63.4	F	78.7	E	63.9	F	99.2
Northbound Right	D	37.2	C	28.9	D	42.8	C	34.3
Southbound Left	D	35.0	E	55.3	C	30.3	D	44.1
Southbound Through	D	45.1	D	46.2	D	35.6	D	44.1
Southbound Shared Through-Right	D	53.0	D	54.3	D	41.0	D	52.0
Scottsdale Road and Paradise Lane (2)								
Overall Intersection	D	54.9	E	57.3	D	50.4	D	45.2
Eastbound Left	D	53.9	E	57.5	D	54.1	E	57.8
Eastbound Through	D	53.9	D	54.7	D	53.9	D	54.7
Eastbound Right	D	53.6	D	54.4	D	53.6	D	54.4
Westbound Left	D	53	D	47.4	D	49	D	41.5
Westbound Through	D	53.7	D	44.8	D	47.3	D	38.9
Westbound Right*	B	10.9	B	18.9	B	19.4	C	65.6
Northbound Left	C	34.0	D	36.2	B	16.5	C	21.9
Northbound Through	E	65.5	E	61.2	D	48.9	D	36.1
Northbound Right	D	48.6	D	36	C	31.7	B	11.3
Southbound Left	C	24.7	D	40.2	C	30.5	D	45.3
Southbound Through	D	53.8	E	56.6	D	54.9	D	54.4
Southbound Right	D	35.3	D	37.6	D	35.2	D	36.5
Scottsdale Road and Kierland Boulevard /Greenway Hayden Loop (5)								
Overall Intersection	D	52.0	D	39.5	D	42	D	43.5
Eastbound Left	D	50.9	D	54.8	D	49.7	D	54.6
Eastbound Through	E	56.1	D	54.8	E	56.1	D	54.8
Eastbound Right	B	15.8	B	17.5	C	24.2	C	20.6
Westbound Left	E	66.0	E	68.3	E	69.6	E	68.3
Westbound Through	E	57.7	E	58.1	E	57.7	E	56.9
Westbound Shared Through-Right	E	59.2	E	64.2	E	59.2	E	61.4
Northbound Left	B	11.6	B	14.5	C	25.5	B	19.8
Northbound Through	C	34.9	C	33.3	D	36.5	C	26.2
Northbound Right	F	166.5	B	15.8	F	147.5	B	10.5
Southbound Left	A	5.8	B	19.9	A	7.5	D	46.0
Southbound Through	C	31.5	D	36.4	B	10.1	D	55.0
Southbound Right	C	21.8	C	34.2	A	8.5	D	53.4

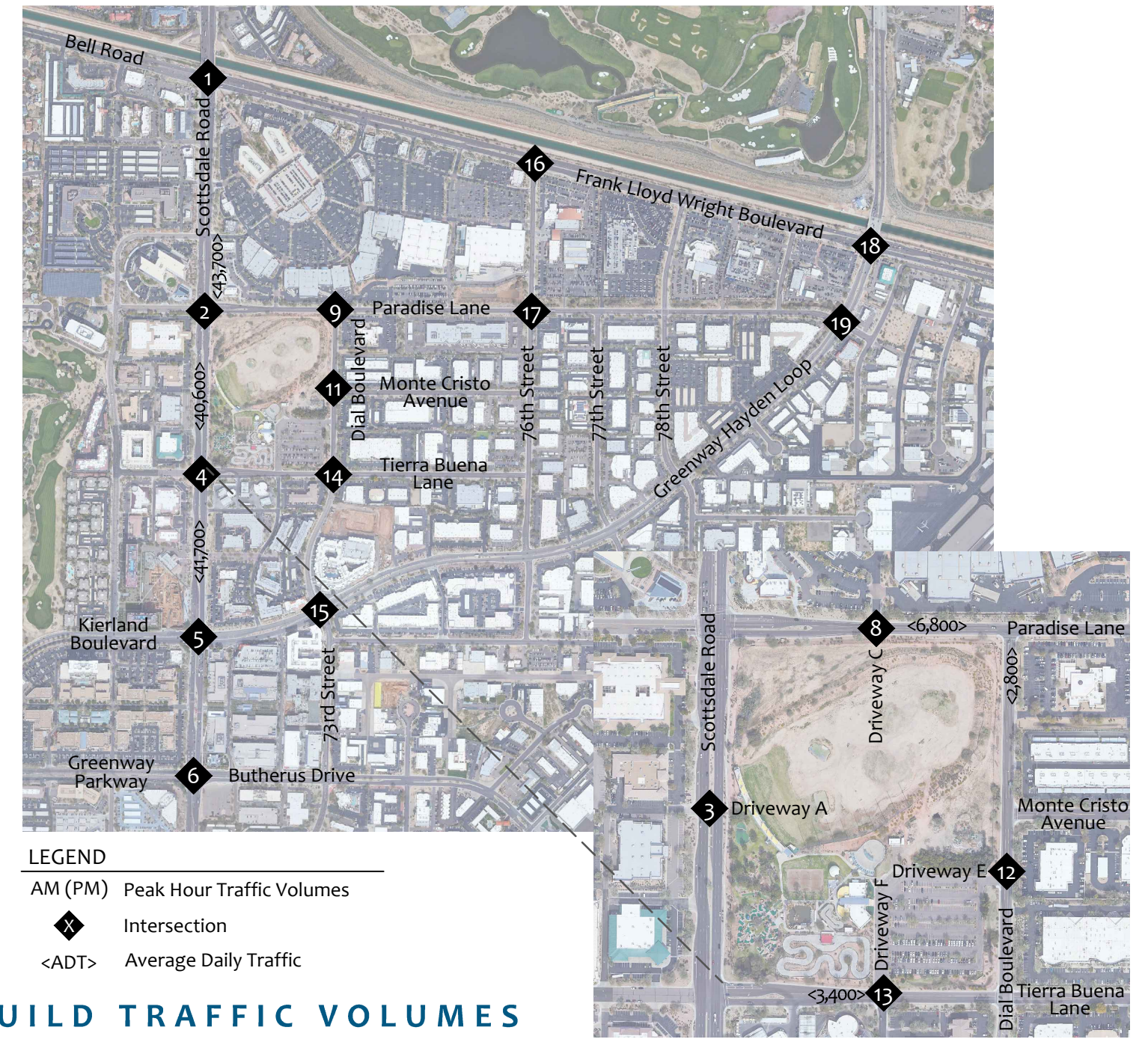
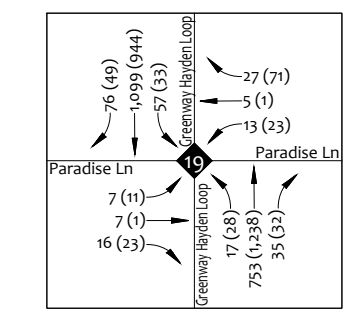
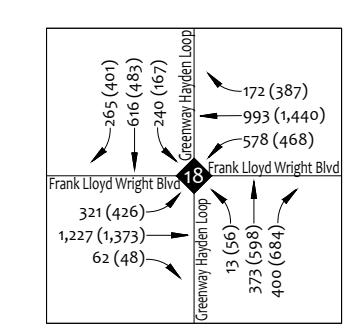
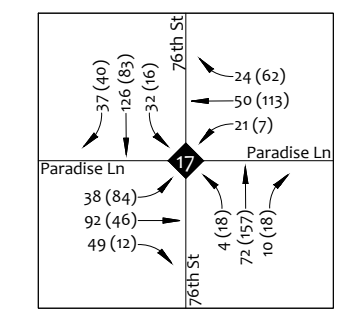
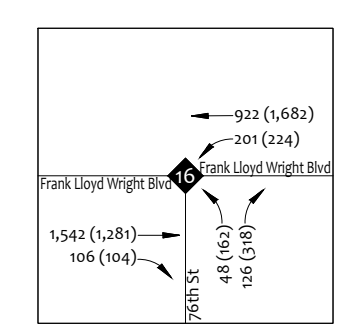
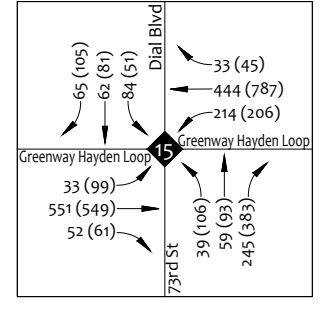
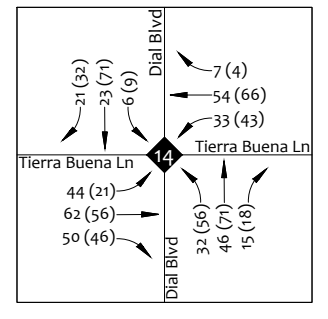
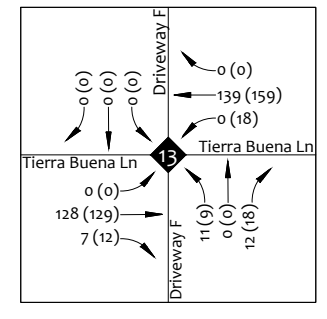
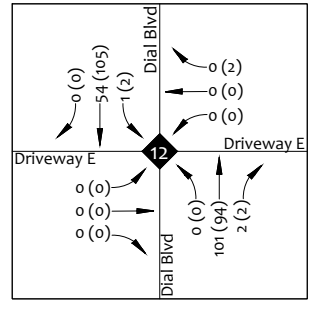
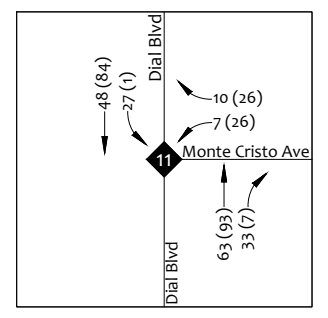
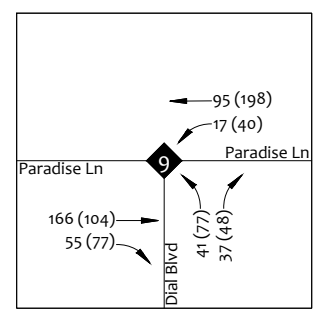
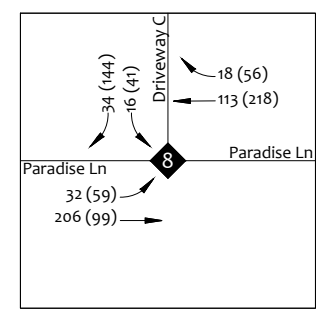
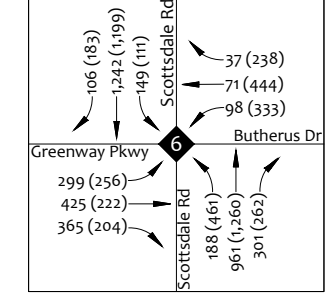
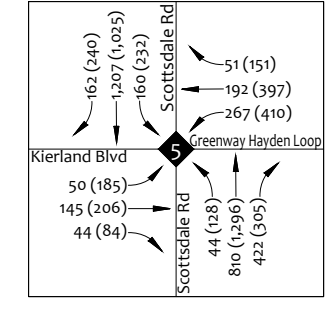
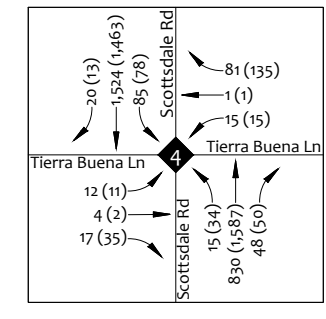
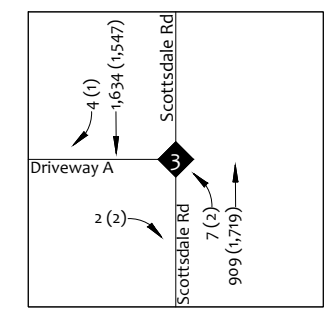
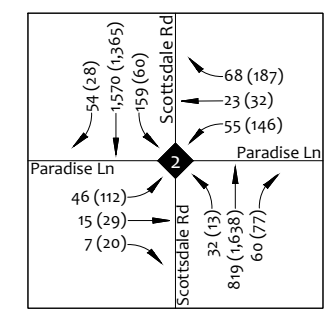
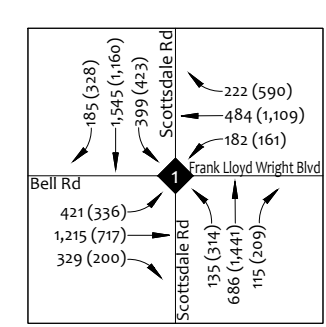
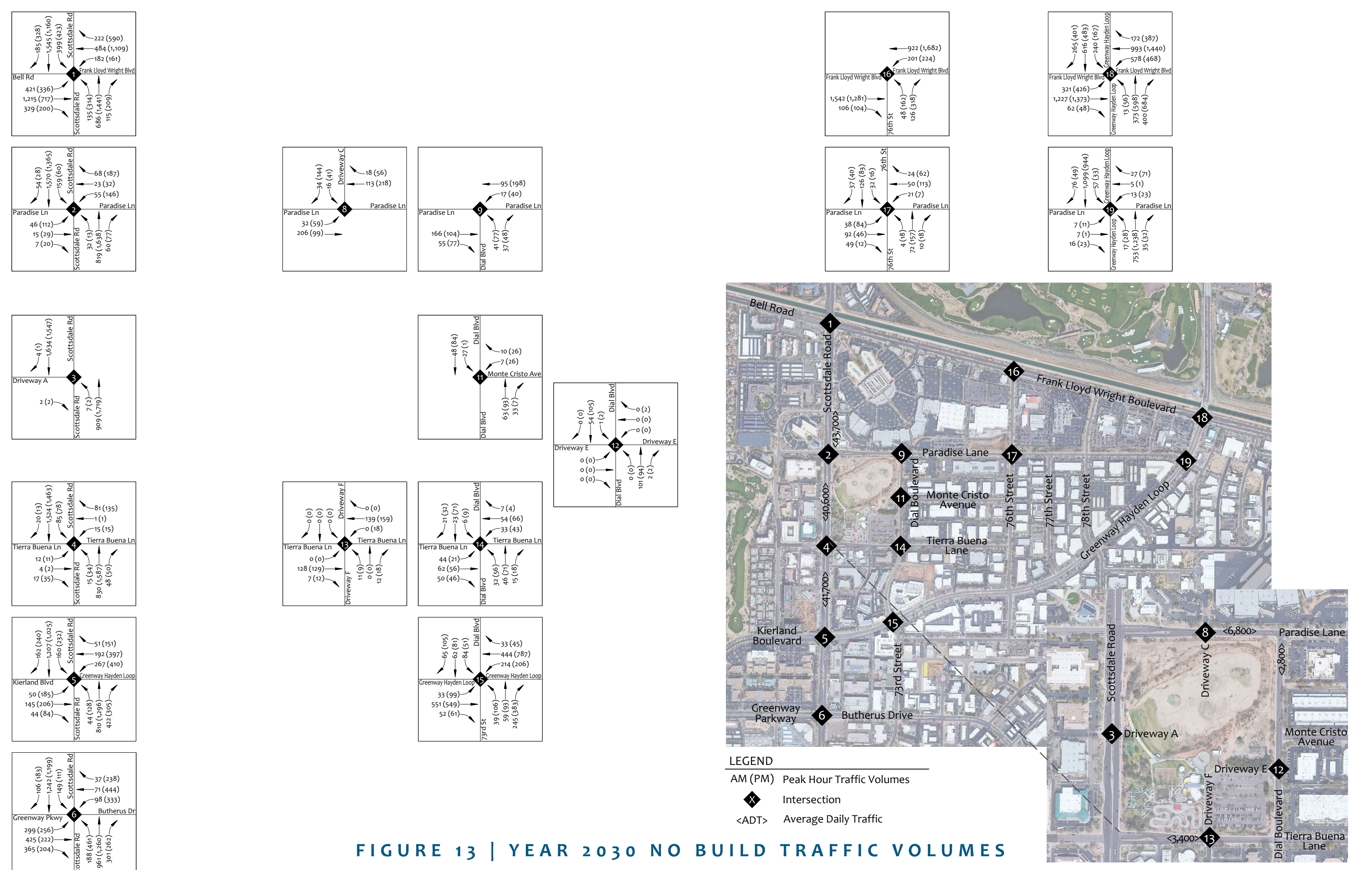
*Synchro Level of Service Reported

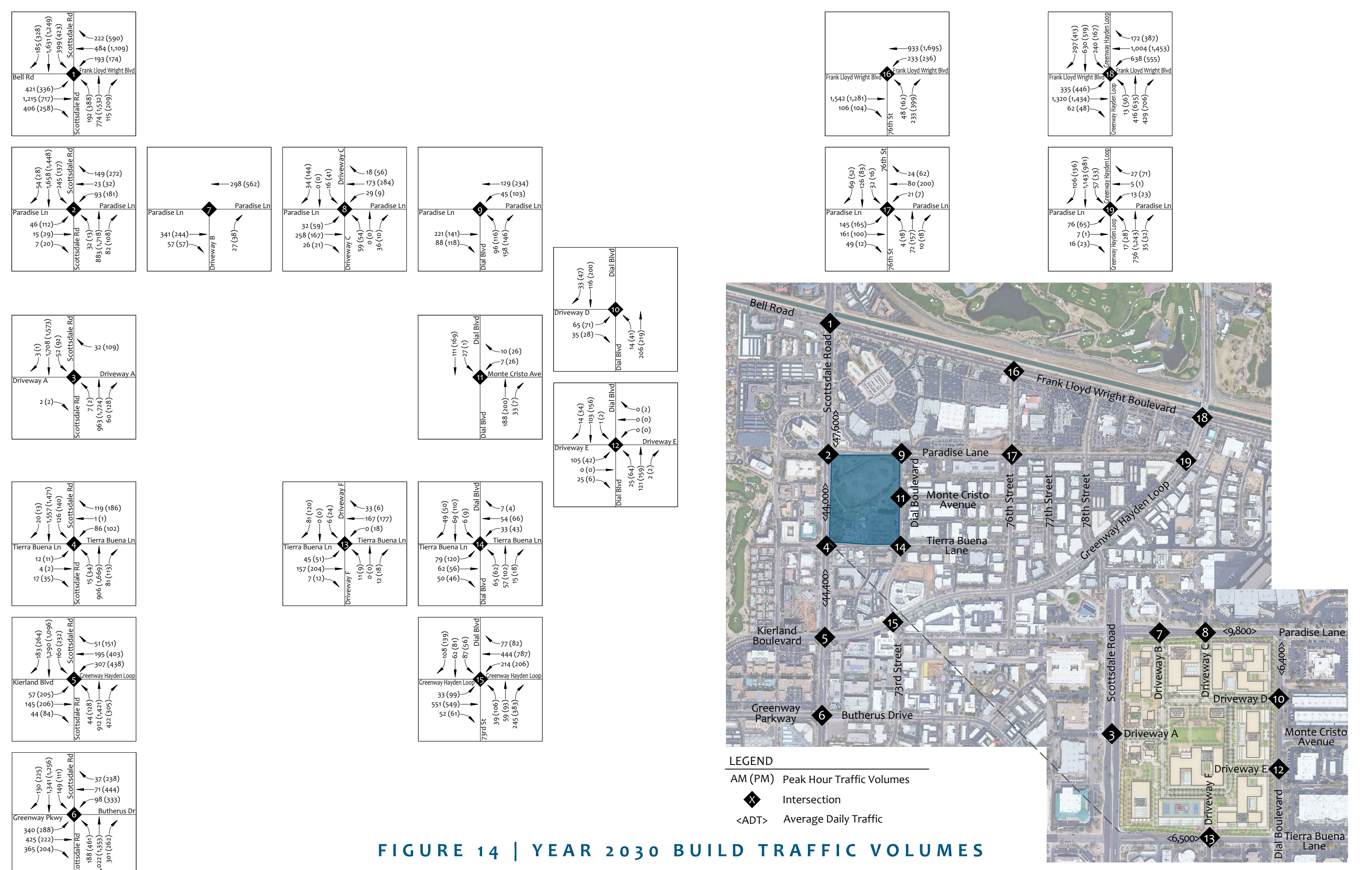


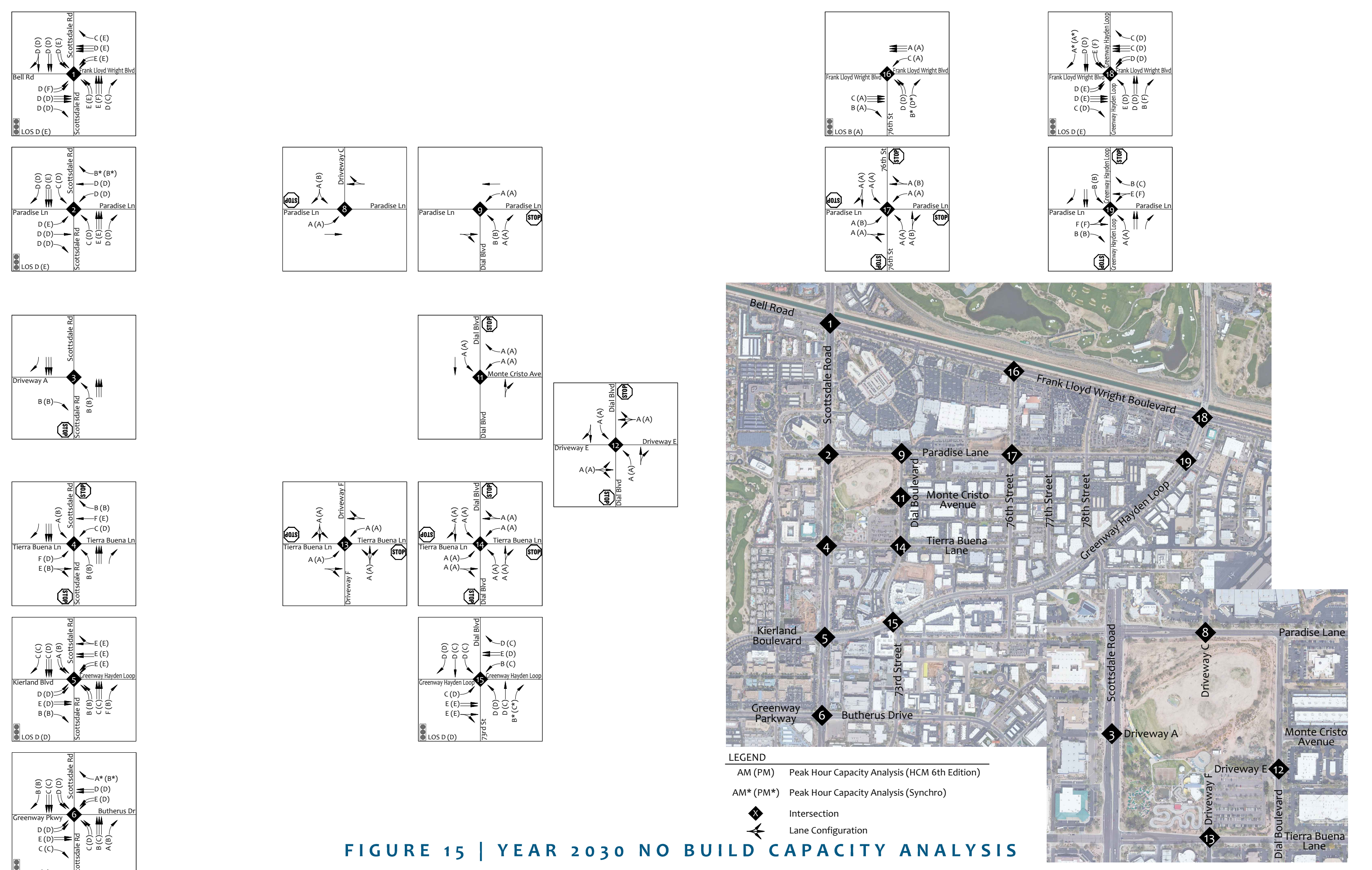
Table 11 – Year 2030 Level of Service and Delay – Signalized – Continued

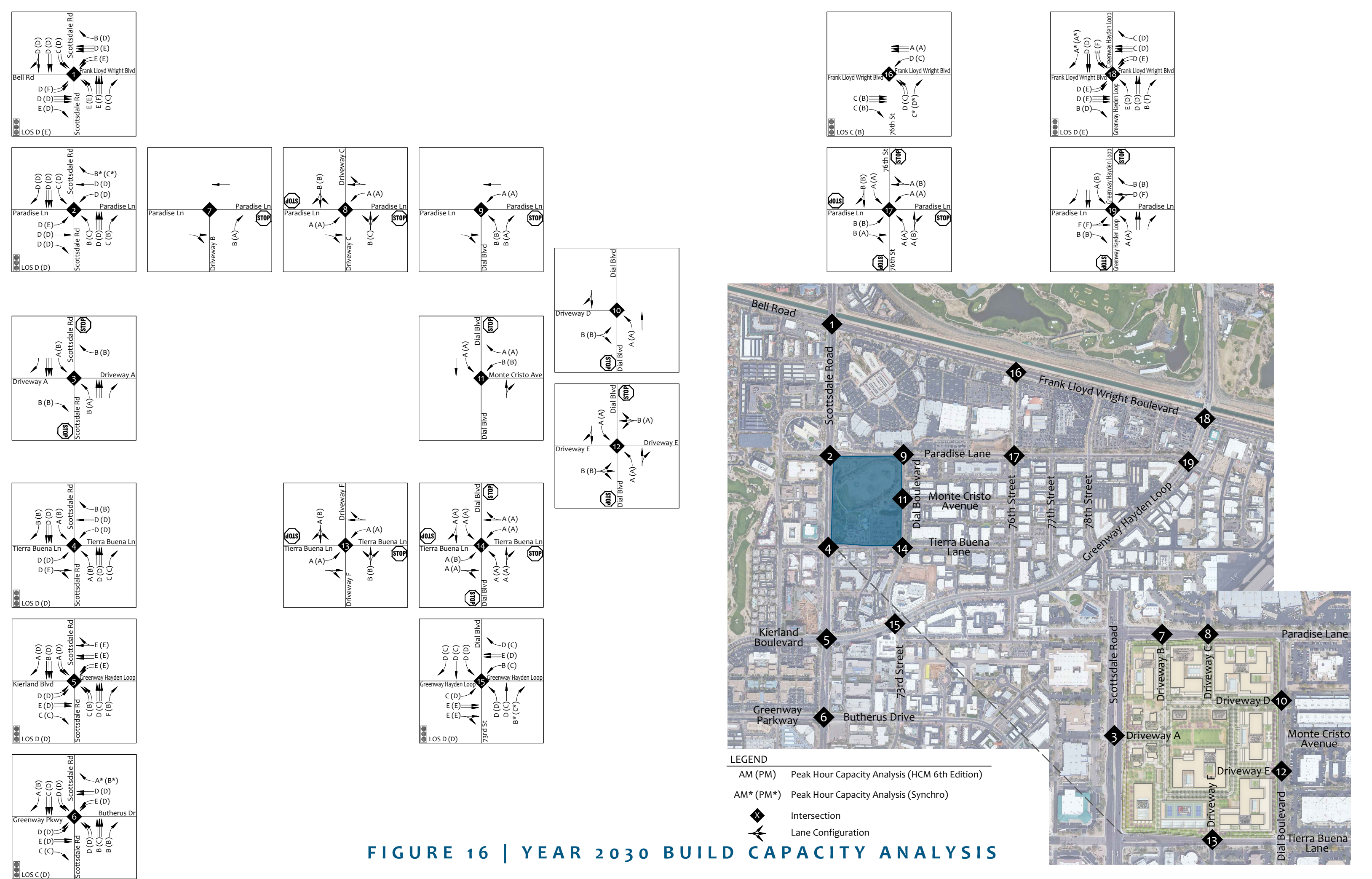
Intersection	2030 No Build				2030 No Build			
	AM PEAK		PM PEAK		AM PEAK		PM PEAK	
	LOS	DELAY	LOS	DELAY	LOS	DELAY	LOS	DELAY
Signalized Intersections								
Scottsdale Road and Greenway Parkway/Butherus Drive (6)								
Overall Intersection	C	33.3	D	38.3	C	32.5	D	39.1
Eastbound Left	D	44.7	D	54.9	D	45.9	D	54.5
Eastbound Through	E	55.4	D	52.6	E	55.4	D	52.7
Eastbound Right	C	21.3	C	25.2	C	22.9	C	26.2
Westbound Left	E	63.1	D	53.5	E	63.1	D	51.1
Westbound Through	D	54.8	D	53.9	D	54.8	D	53.9
Westbound Right*	A	0.8	B	18.7	A	0.8	B	19.4
Northbound Left	C	34.0	D	38.0	D	35.9	D	39.3
Northbound Through	B	19.1	C	21.9	B	19.4	C	23.5
Northbound Right*	A	9.5	B	14.5	B	10.0	B	15.0
Southbound Left	D	53.3	D	54.5	D	53.7	D	54.5
Southbound Through	C	29.5	C	33.7	C	27.1	D	37.3
Southbound Right	B	10.2	B	16.7	A	8.9	B	16.3
Dial Boulevard/73rd St and Greenway Hayden Loop (15)								
Overall Intersection	D	52.8	D	50.5	D	52.7	D	50.4
Eastbound Left	C	22.3	D	37.8	C	22.3	D	37.7
Eastbound Through	E	61.8	E	61.0	E	61.8	E	61.1
Eastbound Shared Through-Right	E	68.8	E	67.5	E	68.8	E	67.7
Westbound Left	B	13.9	C	20.5	B	13.9	C	20.4
Westbound Through	E	59.6	D	49.8	E	59.4	D	49.6
Westbound Right	D	43.6	C	32.4	D	47	C	33.7
Northbound Left	D	44.4	D	38.5	D	44.5	D	38.7
Northbound Through	D	41.3	C	33.2	D	41.3	C	33.3
Northbound Right*	B	13.8	C	23.1	B	13.5	C	22.4
Southbound Left	D	47.1	D	37.5	D	47.4	D	37.9
Southbound Through	D	41.4	C	33.0	D	41.4	C	33.1
Southbound Right	D	41.8	C	33.9	D	43.3	C	34.9
Frank Lloyd Wright Boulevard and 76th Street (16)								
Overall Intersection	B	19.5	A	7.2	C	25.6	B	13.9
Eastbound Through	C	27	A	0.5	C	33.4	B	14.5
Eastbound Right	B	16.5	A	0.2	C	21.9	B	11.6
Westbound Left	C	22.2	A	9.7	D	41.9	C	24.6
Westbound Through	A	0.1	A	0.3	A	0.2	A	0.4
Northbound Left	D	49.0	D	36.8	D	41.3	C	31.7
Northbound Right*	B	19.6	D	41.4	C	23.6	D	43.6
Greenway Hayden Loop and Frank Lloyd Wright Boulevard (18)								
Overall Intersection	D	38.3	E	71	D	40.2	E	74.5
Eastbound Left	D	50.9	E	69	D	49	E	62.9
Eastbound Through	D	43.9	E	56.5	D	43.1	E	56.1
Eastbound Right	C	21.5	D	37.5	B	19.4	D	36.8
Westbound Left	D	35.2	D	47.3	D	40	E	68.8
Westbound Through	C	22.5	D	35.9	C	23.7	D	39.2
Westbound Right	C	20.4	D	36.9	C	21.4	D	40.0
Northbound Left	E	62.7	D	50.7	E	60	D	50.9
Northbound Through	D	52.0	D	51.4	D	52.5	D	54.0
Northbound Right	B	10.2	F	94.3	B	12.0	F	121.9
Southbound Left	E	68.1	F	81.7	E	76.6	F	81.7
Southbound Through	D	54.6	D	54.8	D	54.8	D	54.8
Southbound Right*	A	8.6	A	8.6	A	9.1	A	8.3

*Synchro Level of Service Reported











8. QUEUE ANALYSIS

The 95th percentile queue reported by Synchro was used to calculate the required storage length for the turn lanes at the site driveways. See **Table 12** for the turn bay storage for each required turn lane for year 2030 with the build out of the proposed development.

Table 12 – Queue Analysis

Intersection	Movement	Existing Storage	95th Percentile		Recommended Storage Length
			AM Peak Hour	PM Peak Hour	
Scottsdale Road and Driveway A (3)	NB Right	-	*	*	150'
	SB Left	-	25'	25'	150'
Paradise Lane and Driveway C (8)	WB Left	TWLTL	25'	0'	Sufficient
Dial Boulevard and Driveway D (10)	NB Left	TWLTL	0'	25'	Sufficient
Dial Boulevard and Driveway E (12)	NB Left	TWLTL	25'	25'	Sufficient
Tierra Beuna Lane and Driveway F (13)	EB Left	TWLTL	25'	25'	Sufficient

*Free-flowing right turning movements area not anticipated to queue.



9. TRAFFIC SIGNAL WARRANT

A signal warrant analysis is included using the year 2025 AM and PM peak hour build traffic volumes for the intersections:

- Scottsdale Road and Tierra Buena Lane (4)
- Greenway Hayden Loop and Paradise Lane (19)

The warrant analysis is based on the signal warrants defined in the 2009 Manual on Uniform Traffic Control Devices (MUTCD).

Warrant 1, Eight Hour Volume is the predominant criteria used and is based on minimum traffic volumes that must be present on both the major and minor streets. There are two conditions established for the 8-hour signal warrant. Condition A requires large intersecting traffic volumes. Condition B requires large major street traffic volumes, which limits the ability of the side street to enter or cross the major street. To satisfy the 8-hour signal warrant, either Condition A, Condition B, or 80% of the volume requirements for BOTH Condition A and Condition B must be met for at least 8 hours of the day.

Warrant 2, Four-Hour Vehicular Volume is a 4-hour warrant requiring higher traffic volumes than the 8-hour warrant and is intended to be applied where the volume of intersection traffic is the principal reason for traffic signal installation.

Warrant 3, Peak Hour is a peak hour warrant and applies in unusual cases, such as an office complex, manufacturing plant, or industrial complex, or high-occupancy vehicle facility.

Warrant 4, Pedestrian Volume is intended for use in cases where the volume on a major street is so heavy, the pedestrians experience excessive delay in crossing the major street.

Warrant 5, School Crossing Warrant intended for use in cases where school children do not have adequate gaps to safely cross the major street. A minimum of 20 schoolchildren during the highest hour satisfies this warrant.

Warrant 6, Coordinated Signal System is associated with progressive movement to aid in platooning of vehicles.

Warrant 7, Crash Experience is a crash experience warrant and is for locations where the severity and frequency of crashes are the principal reasons to consider a traffic signal. This warrant requires five or more crashes in a 12-month period that can be corrected by a traffic signal.



Warrant 8, Roadway Network is justified to encourage concentration and organization of traffic flow in a roadway network.

Warrant 9, Intersection Near Grade Crossing is associated with intersections near a grade crossing.

The posted speed limit on Scottsdale Road is 45 mph and the posted speed limit on Greenway Hayden Loop is 40mph. Therefore, per the MUTCD, the 70 percent factor was applied to the applicable warrants.

See summary in **Table 13** below. See **Appendix M** for the detailed traffic signal warrant analysis.

Table 13 – Signal Warrant Analysis Results

Warrant	Description	Satisfied?	
		Scottsdale Road and Tierra Buena Lane (4)	Greenway Hayden Loop and Paradise Lane (19)
1	Eight-Hour Vehicular Volume	YES	NO
2	Four-Hour Vehicular Volume	YES	NO
3	Peak Hour	YES	NO
4	Pedestrian Volume	N/A	N/A
5	School Crossing	N/A	N/A
6	Coordinated Signal System	N/A	N/A
7	Crash Experience	N/A	N/A
8	Roadway Network	N/A	N/A
9	Intersection Near a Grade Crossing	N/A	N/A

A traffic signal is warranted at the intersection of Scottsdale Road and Tierra Buena Lane (4) based on the year 2025 build traffic volumes.

A traffic signal is not warranted at the intersection of Greenway Hayden Loop and Paradise Lane (19) based on the year 2025 build traffic volumes.



10. ALTERNATIVE ANALYSIS

At the request of the City of Scottsdale Transportation Staff, the intersection of Dial Boulevard and Paradise Lane (9) was evaluated as an all-way stop controlled intersection to analyze the impacts of an alternative intersection control. As previously mentioned, this T-intersection currently operates as a one-way stop-controlled intersection, with the stop control on the northbound approach.

Analysis of this intersection with all-way stop control was evaluated utilizing the year 2030 build traffic volumes. See **Table 14** below for a comparison of the 2030 build conditions with Dial Boulevard and Paradise Lane (9) operating with a one-way stop control and an all-way stop-control. See **Appendix N** for detailed capacity sheets.

Table 14 – Dial Boulevard and Paradise Lane Alternative Comparison

Intersection	Year 2030 Build				Year 2030 Build			
	AM PEAK		PM PEAK		AM PEAK		PM PEAK	
Unsignalized Intersections	LOS	DELAY	LOS	DELAY	LOS	DELAY	LOS	DELAY
Dial Boulevard and Paradise Lane (9)	One-way Stop Controlled				All-way Stop Controlled			
Eastbound Shared Through-Right	-	-	-	-	B	12.9	B	12.3
Westbound Left	A	8.0	A	8.0	A	9.5	B	10.5
Westbound Through	-	-	-	-	A	10.0	B	12.3
Northbound Left	B	12.3	C	15.4	B	10.6	B	11.5
Northbound Right	B	10.4	A	9.9	A	9.6	A	10.0



11. RECOMMENDATIONS & CONCLUSIONS

The Parque is located on the southeast corner of Scottsdale Road and Paradise Lane, in Phoenix, Arizona, will be comprised of the following land uses:

- **Multi-Family Residential** **1,236 units**
 - *5 Star Hotel Branded Condominiums* 126 units
 - *Luxury Condominiums* 115 units
 - *Multi-Family Residencies* 897 units
 - *Work Force Residences* 98 units
- **Hotel** **223 rooms**
- **Retail** **25,250 square feet**
- **Restaurant** **35,120 square feet**
- **Office** **150,000 square feet**

The following are the recommendations with the build out of the proposed development:

Scottsdale Road and Driveway A (3)

- Build out of a three-quarter access driveway, allowing right-in, left-in, and right-out movements. Improvements include installation of northbound right turn deceleration lane and a southbound left turn lane.

Scottsdale Road and Tierra Buena Lane (4)

- Installation of a traffic signal.

Paradise Lane and Driveway B (7)

- Build out of a right-in and right-out driveway.

Paradise Lane and Driveway C (8)

- Build out of a full access driveway on the south leg of the existing intersection.

Dial Boulevard and Driveway D (10)

- Build out of a full access driveway on the south leg of the existing intersection.

Dial Boulevard and Driveway E (12)

- Modification to the west leg of the existing intersection on the to accommodate the full access site driveway.

Tierra Buena Lane and Driveway F (13)

- Modification to the north leg of the existing intersection on the to accommodate the site driveway.





Appendix A – Proposed Site Plan

PRELIMINARY

NOT FOR
CONSTRUCTION
OR
RECORDING

**THE PARQUE
PCP APPLICATION**
16001 N SCOTTSDALE RD
SCOTTSDALE, AZ, 85254

DRB # 000-00-0000

ZONING # 000-00-0000

Date

08/19/2022

Drawings and written material appearing herein constitute original and unpublished work of the architect and may not be duplicated, used, or disclosed without written consent of the architect.

© 2019 NELSEN PARTNERS, INC.

Project No.
21018

A110
SITE PLAN

PROJECT INFORMATION

CURRENT ZONING:	C-4	PLANNED AIRPARK CORE DEVELOPMENT AIRPARK MIXED-USE - RESIDENTIAL WITH PLANNED SHARED DEVELOPMENT OVERLAY
PROPOSED ZONING:	PCP-AMU-R-PSD	
GROSS SITE AREA:	1,406,793	SQFT (32.29 ACRES)
NET SITE AREA:	1,207,435	SQFT (27.719 ACRES)
GFAR BASE:	0.8	965,948
GFAR PROPOSED:	1.73	2,086,417
ALLOWED MAXIMUM HEIGHT:	134 FT	(WITH BONUS)
PROPOSED MAXIMUM HEIGHT:	119 FT	(WITH ROOF APPURTENANCES)

PROJECT TABULATIONS

RETAIL	25,250	SQFT	
FLEXIBLE SPACE	42,500	SQFT	
RESTAURANT	35,120	SQFT	
OFFICE	150,000	SQFT	
5 STAR HOTEL	189,075	SQFT	223 KEYS
5 STAR HOTEL BRANDED CONDOMINIUMS	350,132	SQFT	126 RESIDENCES
LUXURY CONDOMINIUMS	319,600	SQFT	115 RESIDENCES
MULTI-FAMILY RESIDENCES	877,266	SQFT	897 RESIDENCES
WORK FORCE RESIDENCES	97,474	SQFT	98 RESIDENCES
TOTAL	2,086,417	SQFT	1,236 RESIDENCES

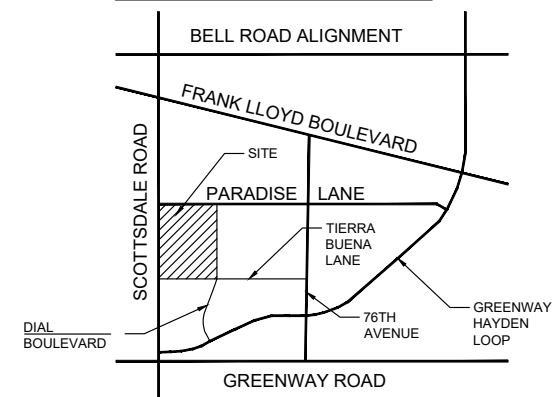
PARKING REQUIRED

5 STAR HOTEL	1 SPACE / 1 KEY	223
RETAIL	1 SPACE / 325 SQFT	78
RESTAURANT	1 SPACE / 325 SQFT	109
RESTAURANT PATIO	1 SPACE / 350 SQFT	43
OFFICE	1 SPACE / 325 SQFT	462
FLEXIBLE SPACE	1 SPACE / 325 SQFT	131
PARK	3 SPACE / ACRE	6
RESIDENCES GUESTS	1 SPACE / 6 RESIDENEC	206
RESIDENCES	1.5 SPACES / RESIDENCE AVG	1,854
TOTAL		3112

PARKING PROVIDED

3162

VICINITY MAP NTS



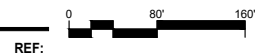
PLAN KEY:

ZONING PARCEL BOUNDARY



01 SITE PLAN

SCALE: 1"=80'



REF:



Appendix B – Collision Data

CITY OF SCOTTSDALE

COLLISION SUMMARY

REPORT #	DATE YYMMDD	TIME HHMM	NORTH / SOUTH ST.	TYPE	EAST WEST ST.	TYPE	DIR FROM	DIST FROM	INJ. SEV.	PHYS. COND. #1 #2	VIOLATION #1 #2	ACTION #1 #2	TRAV. DIR. #1 #2	MANNER OF COLLISION	COMMENTS
1905536	190312	1344	76	ST	FRANK LLOYD WRIGHT	BL	S	75	1	0 0	20 1	4 1	NB NB	2	
1911773	190601	1625	76	ST	FRANK LLOYD WRIGHT	BL	AT		1	0 0	20 1	4 1	SB EB	3	
1916586	190808	1548	76	ST	FRANK LLOYD WRIGHT	BL	AT		1	0 0	20 1	4 1	EB NB	3	
1918716	190905	1608	76	ST	FRANK LLOYD WRIGHT	BL	AT		1	0 0	12 1	8 1	WB WB	6	
1920283	190927	1436	76	ST	FRANK LLOYD WRIGHT	BL	S	150	1	0 0	20 1	4 1	NB SB	3	
1922361	191026	1137	76	ST	FRANK LLOYD WRIGHT	BL	AT		3	0 0	20 1	4 1	SB EB	3	
1922366	191026	1238	76	ST	FRANK LLOYD WRIGHT	BL	AT		1	0 0	2 1	1 1	WB WB	4	
1922743	191031	1306	76	ST	FRANK LLOYD WRIGHT	BL	AT		1	0 0	7 1	5 1	NB EB	6	
1926784	191227	1619	76	ST	FRANK LLOYD WRIGHT	BL	W	600	1	0 0	2 1	7 1	EB EB	4	
2004706	200303	1239	76	ST	FRANK LLOYD WRIGHT	BL	W	150	1	0 0	97 1	12 14	WB WB	5	
2004887	200305	1821	76	ST	FRANK LLOYD WRIGHT	BL	AT		2	0 0	5 1	1 1	EB NB	2	
2011068	200628	1605	76	ST	FRANK LLOYD WRIGHT	BL	W	110	99	99	13 0	1	WB	1	
2011877	200713	1412	76	ST	FRANK LLOYD WRIGHT	BL	AT		1	0 0	0 0	4 1	SB EB	3	
2012882	200731	1350	76	ST	FRANK LLOYD WRIGHT	BL	AT		1	99 0	20 1	4 1	SW EB	3	
2013038	200803	1554	76	ST	FRANK LLOYD WRIGHT	BL	AT		1	0 0	0 1	2 3	WB WB	4	
2018590	201030	1323	76	ST	FRANK LLOYD WRIGHT	BL	AT		3	0 0	20 1	4 1	SB EB	2	
2019741	201117	1929	76	ST	FRANK LLOYD WRIGHT	BL	AT		1	0 0	7 1	5 1	EB EB	2	
2020541	201130	1546	76	ST	FRANK LLOYD WRIGHT	BL	AT		1	0 0	12 1	8 1	WB WB	6	
2022146	201222	2001	76	ST	FRANK LLOYD WRIGHT	BL	AT		1	0 0	20 1	4 1	SB EB	3	
2022348	201227	1210	76	ST	FRANK LLOYD WRIGHT	BL	W	255	2	0 0	4 1	2 3	WB WB	4	
2101319	210120	1708	76	ST	FRANK LLOYD WRIGHT	BL	AT		1	0 0	4 1	1 3	WB WB	4	
2106457	210403	1027	76	ST	FRANK LLOYD WRIGHT	BL	S	230	1	0 0	20 97	4 1	EB NB	2	
2107790	210422	1449	76	ST	FRANK LLOYD WRIGHT	BL	E	550	1	99 0	12 1	8 1	EB EB	6	
2112893	210702	1238	76	ST	FRANK LLOYD WRIGHT	BL			1	99 0	1	10 14	99 99	8	
2113587	210712	1343	76	ST	FRANK LLOYD WRIGHT	BL			2	0 0	7 1	4 1	WB EB	3	
2113672	210713	1401	76	ST	FRANK LLOYD WRIGHT	BL			1	0 0	20 1	4 1	SB EB	2	
2115215	210804	1629	76	ST	FRANK LLOYD WRIGHT	BL			1	99 99	99 99	5 1	EB EB	2	
2119902	211011	1708	76	ST	FRANK LLOYD WRIGHT	BL	E	50	1	0 0	12 1	8 1	WB WB	6	
2120884	211026	1002	76	ST	FRANK LLOYD WRIGHT	BL			1	0 0		5 6	NW EB	6	
1919410	190915	1228	78	ST	FRANK LLOYD WRIGHT	BL	AT		1	99 0	12 1	8 1	EB EB	6	
2103158	210215	1526	78	ST	FRANK LLOYD WRIGHT	BL	S	100	1	0 0	15 1	1 1	NB NB	6	
2120109	211014	1824	78	ST	FRANK LLOYD WRIGHT	BL	W	385	1	0 0	20 1	1 1	EB EB	6	
2124611	211216	1204	78	ST	FRANK LLOYD WRIGHT	BL			2	0 0	20 1	5 1	NE EB	2	
1920753	191004	1103	79	ST	FRANK LLOYD WRIGHT	BL	AT		3	0 0	2 1	1 3	EB EB	4	
1901839	190125	1309	79	ST	FRANK LLOYD WRIGHT	BL	AT		1	0 0	2 1	1 3	EB EB	4	
1907112	190402	1248	79	ST	FRANK LLOYD WRIGHT	BL	AT		1	0 0	20 1	5 3	NB EB	6	

REPORT #	DATE YYMMDD	TIME HHMM	NORTH / SOUTH ST.	TYPE	EAST WEST ST.	TYPE	DIR FROM	DIST FROM	INJ. SEV.	PHYS. COND. #1 #2	VIOLATION #1 #2	ACTION #1 #2	TRAV. DIR. #1 #2	MANNER OF COLLISION	COMMENTS
1908068	190414	1227	79	ST	FRANK LLOYD WRIGHT	BL	W	200	1	99 0	12 1	8 1	WB WB	6	
1915901	190729	1524	79	ST	FRANK LLOYD WRIGHT	BL	AT		1	0 0	2 97	1 2	EB EB	4	
2112621	210628	1219	79	ST	FRANK LLOYD WRIGHT	BL			1	0 0	2 1	1 3	EB EB	4	
2113454	210710	1715	79	ST	FRANK LLOYD WRIGHT	BL			1	0 0	4 1	1 1	EB EB	4	
2117925	210913	1441	79	ST	FRANK LLOYD WRIGHT	BL			1	0 0	2 1	1 1	EB EB	4	
1900240	190104	1847	GREENWAY HAYDEN	LO	FRANK LLOYD WRIGHT	BL	AT		1	0 99	2 1	2 3	WB WB	4	HIT AND RUN
1900957	190113	2114	GREENWAY HAYDEN	LP	FRANK LLOYD WRIGHT	BL	E	800	1	4 0	8 1	6 1	EB WB	7	
1901026	190114	1833	GREENWAY HAYDEN	LP	FRANK LLOYD WRIGHT	BL	AT		1	0 0	1 1	1 1	WB WB	6	
1901258	190117	2204	GREENWAY HAYDEN	LP	FRANK LLOYD WRIGHT	BL	AT		1	0 0	99 1	5 1	WB WB	2	
1901308	190118	1451	GREENWAY HAYDEN	LP	FRANK LLOYD WRIGHT	BL	W	200	1	0 0	12 1	8 1	EB EB	6	
1901762	190124	1426	GREENWAY HAYDEN	LP	FRANK LLOYD WRIGHT	BL	AT		1	0 0	12 1	8 1	SB SB	6	
1903550	190215	0745	GREENWAY HAYDEN	LP	FRANK LLOYD WRIGHT	BL	AT		1	0 0	12 1	8 1	EB EB	6	
1903839	190218	1304	GREENWAY HAYDEN	LP	FRANK LLOYD WRIGHT	BL	E	600	1	0 0	2 1	1 3	WB WB	4	
1903889	190219	0920	GREENWAY HAYDEN	LP	FRANK LLOYD WRIGHT	BL	W	100	1	99 0	97 1	1 4	EB EB	4	
1904061	190221	1241	GREENWAY HAYDEN	LP	FRANK LLOYD WRIGHT	BL	E	785	1	0	2 0	1	EB	1	
1904509	190227	0755	GREENWAY HAYDEN	LP	FRANK LLOYD WRIGHT	BL	W	500	1	0 0	2 1	1 3	EB EB	4	
1904935	190304	1748	GREENWAY HAYDEN	LP	FRANK LLOYD WRIGHT	BL	AT		1	0 0	2 1	1 5	WB WB	4	
1905667	190314	1330	GREENWAY HAYDEN	LP	FRANK LLOYD WRIGHT	BL	S	1100	1	0 0	0 99	1 1	NB NB	6	
1906315	190322	1510	GREENWAY HAYDEN	LP	FRANK LLOYD WRIGHT	BL	E	552	2	0 0	2 1	1 3	WB WB	4	
1907097	190402	1218	GREENWAY HAYDEN	LP	FRANK LLOYD WRIGHT	BL	E	245	1	0 0	97 1	10 1	WB WB	8	
1908894	190424	1546	GREENWAY HAYDEN	LP	FRANK LLOYD WRIGHT	BL	AT		1	0 0	2 1	8 3	WB WB	4	
1909404	190501	1605	GREENWAY HAYDEN	LP	FRANK LLOYD WRIGHT	BL	AT		1	0 0	2 1	1 1	SB SB	4	
1910107	190510	1615	GREENWAY HAYDEN	LP	FRANK LLOYD WRIGHT	BL	AT		1	0 0	2 1	2 3	WB WB	4	
1913665	190627	1021	GREENWAY HAYDEN	LP	FRANK LLOYD WRIGHT	BL	E	200	2	0 0	2 1	1 3	WB WB	4	
1913975	190701	1419	GREENWAY HAYDEN	LP	FRANK LLOYD WRIGHT	BL	AT		1	0 0	2 1	2 3	EB EB	4	
1914709	190712	1318	GREENWAY HAYDEN	LP	FRANK LLOYD WRIGHT	BL	E	500	1	99 0	97 1	1 3	NB NB	4	
1914967	190716	1332	GREENWAY HAYDEN	LP	FRANK LLOYD WRIGHT	BL	W	1000	1	0 0	2 1	2 3	EB EB	4	
1915593	190725	1219	GREENWAY HAYDEN	LP	FRANK LLOYD WRIGHT	BL	W	313	2	0 0	0 1	1 3	EB EB	4	
1916110	190801	1537	GREENWAY HAYDEN	LP	FRANK LLOYD WRIGHT	BL	E	60	1	0 0	97 1	1 3	EB EB	4	
1916391	190805	1248	GREENWAY HAYDEN	LP	FRANK LLOYD WRIGHT	BL	AT		1	0 0	2 1	1 3	EB EB	4	
1917008	190814	0702	GREENWAY HAYDEN	LP	FRANK LLOYD WRIGHT	BL	W	1000	1	0 0	12 1	8 1	WB WB	6	
1918298	190831	1141	GREENWAY HAYDEN	LP	FRANK LLOYD WRIGHT	BL	AT		1	0 0	4 4	1 1	WB WB	4	
1919187	190912	1803	GREENWAY HAYDEN	LP	FRANK LLOYD WRIGHT	BL	AT		1	0	1 0	1	WB	5	
1919637	190918	1642	GREENWAY HAYDEN	LP	FRANK LLOYD WRIGHT	BL	AT		1	0 0	2 1	1 3	EB EB	4	
1919750	190920	1224	GREENWAY HAYDEN	LP	FRANK LLOYD WRIGHT	BL	W	645	2	0 0	2 1	2 2	WB WB	4	
1919814	190921	1242	GREENWAY HAYDEN	LP	FRANK LLOYD WRIGHT	BL	AT		1	0 0	97 1	1 1	WB WB	4	
1920492	190930	1508	GREENWAY HAYDEN	LP	FRANK LLOYD WRIGHT	BL	AT		2	0 0	4 1	2 3	WB WB	4	
1921257	191011	1156	GREENWAY HAYDEN	LP	FRANK LLOYD WRIGHT	BL	E	500	1	0 0	2 1	1 3	WB WB	4	

REPORT #	DATE YYMMDD	TIME HHMM	NORTH / SOUTH ST.	TYPE	EAST WEST ST.	TYPE	DIR FROM	DIST FROM	INJ. SEV.	PHYS. COND. #1 #2	VIOLATION #1 #2	ACTION #1 #2	TRAV. DIR. #1 #2	MANNER OF COLLISION	COMMENTS
1921931	191020	1543	GREENWAY HAYDEN	LP	FRANK LLOYD WRIGHT	BL	AT		1	0 0	13 13	1 1	EB EB	6	
1922171	191023	1833	GREENWAY HAYDEN	LP	FRANK LLOYD WRIGHT	BL	AT		1	0 0	13 1	1 1	EB EB	6	
1923127	191105	1036	GREENWAY HAYDEN	LP	FRANK LLOYD WRIGHT	BL	AT		1	0 0	1 1	1 1	EB EB	6	
1923832	191114	1721	GREENWAY HAYDEN	LP	FRANK LLOYD WRIGHT	BL	AT		1	0 0	4 1	1 2	SB SB	4	
1925003	191202	0808	GREENWAY HAYDEN	LP	FRANK LLOYD WRIGHT	BL	E	300	2	0 0	4 1	1 3	WB WB	4	
1925005	191202	0858	GREENWAY HAYDEN	LP	FRANK LLOYD WRIGHT	BL	E	300	1	0 0	4 1	1 3	WB WB	4	
1925021	191202	1123	GREENWAY HAYDEN	LP	FRANK LLOYD WRIGHT	BL	E	20	2	0 0	2 1	1 3	WB WB	4	
1925612	191210	0527	GREENWAY HAYDEN	LP	FRANK LLOYD WRIGHT	BL	AT		2	0 0	6 1	1 1	WB SB	2	
1926959	191229	2124	GREENWAY HAYDEN	LP	FRANK LLOYD WRIGHT	BL	AT		1	99 0	7 1	6 4	EB EB	2	
2001177	200116	1745	GREENWAY HAYDEN	LP	FRANK LLOYD WRIGHT	BL	W	320	1	0 0	0 1	1 3	EB EB	4	
2001730	200124	1217	GREENWAY HAYDEN	LP	FRANK LLOYD WRIGHT	BL	AT		1	0 0	2 1	1 1	EB EB	4	
2002050	200128	1158	GREENWAY HAYDEN	LP	FRANK LLOYD WRIGHT	BL	N	300	1	0 0	2 1	1 3	NB NB	4	
2002297	200131	1416	GREENWAY HAYDEN	LP	FRANK LLOYD WRIGHT	BL	AT		1	99 0	2 1	4 4	WB WB	4	
2002646	200204	1911	GREENWAY HAYDEN	LP	FRANK LLOYD WRIGHT	BL	AT		1	0 0	7 1	5 1	NB EB	2	
2004704	200303	1252	GREENWAY HAYDEN	LP	FRANK LLOYD WRIGHT	BL	E	600	1	0 0	2 1	1 3	WB WB	4	
2005329	200311	1503	GREENWAY HAYDEN	LP	FRANK LLOYD WRIGHT	BL	AT		1	0 0	2 1	2 3	WB WB	4	
2010050	200611	1656	GREENWAY HAYDEN	LP	FRANK LLOYD WRIGHT	BL	E	100	1	0 0	4 1	1 3	WB WB	4	
2010093	200612	0818	GREENWAY HAYDEN	LP	FRANK LLOYD WRIGHT	BL	W	20	1	0 0	13 1	5 1	WB WB	2	
2012425	200723	1156	GREENWAY HAYDEN	LP	FRANK LLOYD WRIGHT	BL	AT		1	0 0	2 1	1 3	WB WB	4	
2014030	200820	1249	GREENWAY HAYDEN	LP	FRANK LLOYD WRIGHT	BL	AT		1	0 0	2 1	1 2	WB WB	4	
2014444	200827	1338	GREENWAY HAYDEN	LP	FRANK LLOYD WRIGHT	BL	AT		1	0 0	2 1	2 3	EB EB	4	
2014532	200828	1730	GREENWAY HAYDEN	LP	FRANK LLOYD WRIGHT	BL	E	200	1	99 0	12 1	8 3	WB WB	6	
2014982	200904	1825	GREENWAY HAYDEN	LP	FRANK LLOYD WRIGHT	BL	E	515	1	0 0	0 1	1 3	WB WB	4	
2015329	200910	1447	GREENWAY HAYDEN	LP	FRANK LLOYD WRIGHT	BL	AT		1	0 0	2 1	1 4	EB EB	4	
2018794	201102	1406	GREENWAY HAYDEN	LP	FRANK LLOYD WRIGHT	BL	AT		3	0 0	2 1	1 3	EB EB	4	
2018972	201105	1435	GREENWAY HAYDEN	LP	FRANK LLOYD WRIGHT	BL	W	10	1	0 0	0 1	8 3	EB EB	4	
2020596	201201	1502	GREENWAY HAYDEN	LP	FRANK LLOYD WRIGHT	BL	AT		1	0 0	7 1	1 8	WB WB	7	
2021004	201207	0757	GREENWAY HAYDEN	LP	FRANK LLOYD WRIGHT	BL	AT		1	0	7 0	5	EB	1	
2002318	200131	1912	GREENWAY-HAYDEN	LP	FRANK LLOYD WRIGHT	BL	AT		1	0 0	20 1	5 6	NB NB	2	
2003348	200214	1257	GREENWAY-HAYDEN	LP	FRANK LLOYD WRIGHT	BL	AT		1	0 0	2 1	1 3	EB EB	4	
2004648	200302	1520	GREENWAY-HAYDEN	LP	FRANK LLOYD WRIGHT	BL	W	739	2	0 0	4 1	1 3	WB WB	4	
2005188	200309	1256	GREENWAY-HAYDEN	LP	FRANK LLOYD WRIGHT	BL	AT		1	0 0	7 1	5 6	WB WB	2	
2005307	200311	1134	GREENWAY-HAYDEN	LP	FRANK LLOYD WRIGHT	BL	W	200	1	0 0	0 1	1 3	WB WB	4	
2012109	200717	1431	GREENWAY-HAYDEN	LP	FRANK LLOYD WRIGHT	BL	E	40	2	0 0	2 1	1 3	WB WB	4	
2013442	200810	0905	GREENWAY-HAYDEN	LP	FRANK LLOYD WRIGHT	BL	AT		2	0 0	6 1	1 4	WB NB	2	
2015462	200912	1259	GREENWAY-HAYDEN	LP	FRANK LLOYD WRIGHT	BL	AT		2	0 0	2 1	1 3	SB SB	4	
2100034	210101	1640	GREENWAY-HAYDEN	LP	FRANK LLOYD WRIGHT	BL	AT		1	0 0	20 1	5 1	SB EB	2	
2101926	210129	1636	GREENWAY-HAYDEN	LP	FRANK LLOYD WRIGHT	BL	W	250	1	0 0	4 1	1 3	EB EB	4	

REPORT #	DATE YYMMDD	TIME HHMM	NORTH / SOUTH ST.	TYPE	EAST WEST ST.	TYPE	DIR FROM	DIST FROM	INJ. SEV.	PHYS. COND. #1 #2	VIOLATION #1 #2	ACTION #1 #2	TRAV. DIR. #1 #2	MANNER OF COLLISION	COMMENTS
2102680	210208	1700	GREENWAY-HAYDEN	LP	FRANK LLOYD WRIGHT	BL	AT		1	0 0	2 1	1 1	WB WB	4	
2104125	210301	1647	GREENWAY-HAYDEN	LP	FRANK LLOYD WRIGHT	BL	AT		1	0 0	2 1	1 1	WB WB	4	
2104298	210304	0957	GREENWAY-HAYDEN	LP	FRANK LLOYD WRIGHT	BL	AT		2	0 0	7 1	5 1	EB EB	2	
2104672	210309	1122	GREENWAY-HAYDEN	LP	FRANK LLOYD WRIGHT	BL	W	500	1	0 0	2 1	1 3	EB EB	4	
2106474	210403	1640	GREENWAY-HAYDEN	LP	FRANK LLOYD WRIGHT	BL	AT		1	0 0	2 1	2 3	EB EB	4	
2107473	210418	0539	GREENWAY-HAYDEN	LP	FRANK LLOYD WRIGHT	BL	AT		1	0 0	6 1	1 1	EB NB	5	
2110899	210602	1707	GREENWAY-HAYDEN	LP	FRANK LLOYD WRIGHT	BL	S	15	1	0 0	4 1	1 3	NB NB	4	
2111272	210608	1335	GREENWAY-HAYDEN	LP	FRANK LLOYD WRIGHT	BL	E	200	3	0 0	2 1	1 1	WB WB	4	
2111726	210615	0926	GREENWAY-HAYDEN	LP	FRANK LLOYD WRIGHT	BL	E	256	1	3 0	2 1	1 1	EB EB	4	
2112307	210623	1423	GREENWAY-HAYDEN	LP	FRANK LLOYD WRIGHT	BL			1	0 0	13 1	4 3	SB NB	2	
2113757	210714	1604	GREENWAY-HAYDEN	LP	FRANK LLOYD WRIGHT	BL			1	0 0	97 1	1 3	WB WB	4	
2116245	210819	1557	GREENWAY-HAYDEN	LP	FRANK LLOYD WRIGHT	BL	W	200	2	0 0	4 1	1 3	EB EB	4	
2117083	210901	0836	GREENWAY-HAYDEN	LP	FRANK LLOYD WRIGHT	BL			1	0 0	4 1	1 4	SB SB	4	
2117170	210902	1426	GREENWAY-HAYDEN	LP	FRANK LLOYD WRIGHT	BL	N	0	2	0 0	2 1	1 2	SB SB	4	
2117864	210912	1521	GREENWAY-HAYDEN	LP	FRANK LLOYD WRIGHT	BL			1	0 0	6 1	1 4	SB EB	2	
2118268	210918	1033	GREENWAY-HAYDEN	LP	FRANK LLOYD WRIGHT	BL	W	15	1	99 0	4 1	99 2	WB WB	4	
2119097	210930	1158	GREENWAY-HAYDEN		FRANK LLOYD WRIGHT	BL	E	979	1	0 0	2 1	1 1	WB WB	4	
2121609	211104	1324	GREENWAY-HAYDEN	LP	FRANK LLOYD WRIGHT	BL			1	0 0	2 1	1 3	EB EB	4	
2122491	211116	1456	GREENWAY-HAYDEN	LP	FRANK LLOYD WRIGHT	BL	W	1479	3	0 0	97 1	17 5	WB NB	2	BIKE
2122538	211117	1216	GREENWAY-HAYDEN	LP	FRANK LLOYD WRIGHT	BL	W	200	3	4 0	2 1	1 1	WB WB	4	
2123705	211204	1244	GREENWAY-HAYDEN	LP	FRANK LLOYD WRIGHT	BL			1	0 0	2 1	1 1	WB WB	4	
2125456	211228	1514	GREENWAY-HAYDEN	LP	FRANK LLOYD WRIGHT	BL	W	600	1	0 0	2 1	1 3	WB WB	4	
1923834	191114	1745	HAYDEN	RD	FRANK LLOYD WRIGHT	BL	AT		1	0 0	99 99	1 1	EB EB	6	
1900564	190109	0634	HAYDEN	RD	FRANK LLOYD WRIGHT	BL	AT		1	99 0	20 1	5 1	NB EB	2	
1901090	190115	1632	HAYDEN	RD	FRANK LLOYD WRIGHT	BL	W	419	2	0 0	2 1	2 3	EB EB	4	
1903001	190207	1250	HAYDEN	RD	FRANK LLOYD WRIGHT	BL	AT		1	0 0	20 1	4 1	WB NB	3	
1903439	190213	1520	HAYDEN	RD	FRANK LLOYD WRIGHT	BL	AT		1	0 0	2 1	8 3	EB EB	4	
1903524	190214	1915	HAYDEN	RD	FRANK LLOYD WRIGHT	BL	AT		1	0 0	12 1	8 1	EB EB	2	
1906403	190323	2246	HAYDEN	RD	FRANK LLOYD WRIGHT	BL	AT		1	0 0	1 1	1 1	WB WB	6	
1906898	190330	1130	HAYDEN	RD	FRANK LLOYD WRIGHT	BL	AT		1	0 0	4 1	1 3	EB EB	4	
1907141	190402	2052	HAYDEN	RD	FRANK LLOYD WRIGHT	BL	E	25	3	0 0	2 1	1 3	EB EB	4	
1908817	190423	1633	HAYDEN	RD	FRANK LLOYD WRIGHT	BL	AT		3	0 0	2 1	1 3	EB EB	4	
1911146	190524	1620	HAYDEN	RD	FRANK LLOYD WRIGHT	BL	AT		1	0 0	2 1	1 3	WB WB	4	
1913037	190619	1223	HAYDEN	RD	FRANK LLOYD WRIGHT	BL	W	500	1	0 0	2 1	1 3	EB EB	4	
1913242	190621	1855	HAYDEN	RD	FRANK LLOYD WRIGHT	BL	AT		1	0 0	2 1	1 2	EB EB	4	
1913983	190701	1632	HAYDEN	RD	FRANK LLOYD WRIGHT	BL	E	150	2	0 0	2 1	1 3	EB EB	4	
1915844	190728	1640	HAYDEN	RD	FRANK LLOYD WRIGHT	BL	AT		2	0 0	2 1	1 2	EB EB	4	
1916656	190809	1452	HAYDEN	RD	FRANK LLOYD WRIGHT	BL	E	849	1	0 0	99 99	1 1	EB EB	6	

REPORT #	DATE YYMMDD	TIME HHMM	NORTH / SOUTH ST.	TYPE	EAST WEST ST.	TYPE	DIR FROM	DIST FROM	INJ. SEV.	PHYS. COND. #1 #2	VIOLATION #1 #2	ACTION #1 #2	TRAV. DIR. #1 #2	MANNER OF COLLISION	COMMENTS
1917462	190820	1444	HAYDEN	RD	FRANK LLOYD WRIGHT	BL	AT		1	1 1	4 1	1 3	EB EB	4	
1917595	190822	1705	HAYDEN	RD	FRANK LLOYD WRIGHT	BL	W	600	1	99 0	0 1	1 1	EB EB	4	
1917959	190827	0831	HAYDEN	RD	FRANK LLOYD WRIGHT	BL	AT		2	99 0	99 1	99 3	EB EB	4	
1918727	190905	1936	HAYDEN	RD	FRANK LLOYD WRIGHT	BL	AT		1	0 0	1 1	1 1	EB EB	6	
1919598	190918	0804	HAYDEN	RD	FRANK LLOYD WRIGHT	BL	AT		1	0 0	0 1	5 3	WB WB	4	
1922126	191023	0812	HAYDEN	RD	FRANK LLOYD WRIGHT	BL	AT		1	0 0	4 1	2 2	EB EB	4	
1923315	191107	1718	HAYDEN	RD	FRANK LLOYD WRIGHT	BL	E	500	1	0 0	2 1	1 3	EB EB	4	
1923459	191109	1050	HAYDEN	RD	FRANK LLOYD WRIGHT	BL	AT		1	0 0	2 1	1 3	EB EB	4	
1923544	191110	1154	HAYDEN	RD	FRANK LLOYD WRIGHT	BL	AT		1	0 0	12 2	4 1	WB WB	4	
1923926	191115	2106	HAYDEN	RD	FRANK LLOYD WRIGHT	BL	AT		4	0 0	6 1	17 5	EB NB	2	
1926385	191220	1455	HAYDEN	RD	FRANK LLOYD WRIGHT	BL	W	200	1	0 0	2 1	1 2	EB EB	4	
1926776	191227	1345	HAYDEN	RD	FRANK LLOYD WRIGHT	BL	E	500	2	0 0	2 1	1 3	WB WB	4	
1926779	191227	1517	HAYDEN	RD	FRANK LLOYD WRIGHT	BL	AT		1	0 0	2 1	1 3	WB WB	4	
2000617	200109	1817	HAYDEN	RD	FRANK LLOYD WRIGHT	BL	W	830	1	0 0	12 1	8 1	EB EB	6	
2001978	200127	1319	HAYDEN	RD	FRANK LLOYD WRIGHT	BL	AT		1	0 0	7 1	5 4	NB SB	6	
2003268	200213	1159	HAYDEN	RD	FRANK LLOYD WRIGHT	BL	W	300	1	0 0	12 1	8 1	EB EB	6	
2003442	200215	1353	HAYDEN	RD	FRANK LLOYD WRIGHT	BL	S	100	1	99 0	0 1	10 10	99 99	9	
2003861	200221	1350	HAYDEN	RD	FRANK LLOYD WRIGHT	BL	S	655	1	0 0	20 1	5 1	NB NB	2	
2005384	200312	1319	HAYDEN	RD	FRANK LLOYD WRIGHT	BL	EB	500	1	0 0	2 1	1 1	EB EB	4	
2007900	200505	2206	HAYDEN	RD	FRANK LLOYD WRIGHT	BL	W	300	1	0 0	12 1	8 1	WB WB	6	
2008653	200519	1135	HAYDEN	RD	FRANK LLOYD WRIGHT	BL	AT		3	0 0	2 1	2 3	WB WB	4	
2009840	200608	1013	HAYDEN	RD	FRANK LLOYD WRIGHT	BL	S	685	2	0 0	0 17	4 17	SB EB	3	
2010474	200618	1111	HAYDEN	RD	FRANK LLOYD WRIGHT	BL	W	200	1	0 0	2 1	1 3	EB EB	4	
2010995	200627	1113	HAYDEN	RD	FRANK LLOYD WRIGHT	BL	W	88	1	0 0	2 1	1 3	EB EB	4	
2011213	200701	1536	HAYDEN	RD	FRANK LLOYD WRIGHT	BL	AT		1	0 0	12 1	8 1	WB WB	6	
2013974	200819	1206	HAYDEN	RD	FRANK LLOYD WRIGHT	BL	AT		1	0 0	6 1	1 4	EB SW	5	
2014153	200822	1000	HAYDEN	RD	FRANK LLOYD WRIGHT	BL	S	20	3	0	2 0	5	SE	1	
2014393	200826	1342	HAYDEN	RD	FRANK LLOYD WRIGHT	BL	AT		1	0 0	1 1	4 4	WB WB	4	
2015684	200916	1410	HAYDEN	RD	FRANK LLOYD WRIGHT	BL	AT		1	0 0	4 1	2 2	EB EB	4	
2016433	200928	1011	HAYDEN	RD	FRANK LLOYD WRIGHT	BL	AT		1	0 0	99 99	4 1	NE WB	3	
2016581	200930	1146	HAYDEN	RD	FRANK LLOYD WRIGHT	BL	E	140	1	99 0	97 1	1 4	WB WB	4	
2017627	201016	1252	HAYDEN	RD	FRANK LLOYD WRIGHT	BL	N	300	1	0 0	7 1	5 1	NB NB	2	
2017708	201017	1901	HAYDEN	RD	FRANK LLOYD WRIGHT	BL	N	717	1	0 0	0 1	1 3	SB SB	4	
2018361	201027	0950	HAYDEN	RD	FRANK LLOYD WRIGHT	BL	W	400	99	0 0	2 1	1 3	WB WB	4	
2019333	201111	1457	HAYDEN	RD	FRANK LLOYD WRIGHT	BL	AT		1	0 0	20 1	5 1	EB EB	6	
2020682	201202	1340	HAYDEN	RD	FRANK LLOYD WRIGHT	BL	W	300	1	0 0	2 1	2 3	WB WB	4	
2100656	210110	1249	HAYDEN	RD	FRANK LLOYD WRIGHT	BL	AT		1	0 0	97 1	1 3	EB EB	4	
2101218	210119	0658	HAYDEN	RD	FRANK LLOYD WRIGHT	BL	AT		1	99 0	99 1	4 4	wb wb	4	

REPORT #	DATE YYMMDD	TIME HHMM	NORTH / SOUTH ST.	TYPE	EAST WEST ST.	TYPE	DIR FROM	DIST FROM	INJ. SEV.	PHYS. COND. #1 #2	VIOLATION #1 #2	ACTION #1 #2	TRAV. DIR. #1 #2	MANNER OF COLLISION	COMMENTS
2101517	210123	1353	HAYDEN	RD	FRANK LLOYD WRIGHT	BL	N	200	1	0 0	7 1	8 2	NB NB	6	
2102038	210131	0553	HAYDEN	RD	FRANK LLOYD WRIGHT	BL	E	114	3	99 0	1 1	97 1	WB WB	6	
2102058	210131	1153	HAYDEN	RD	FRANK LLOYD WRIGHT	BL	AT		1	0 0	1 1	1 1	EB EB	6	
2102444	210205	1338	HAYDEN	RD	FRANK LLOYD WRIGHT	BL	AT		99	99 0	13 12	4 4	SB SB	3	
2102813	210210	1614	HAYDEN	RD	FRANK LLOYD WRIGHT	BL	W		1	0 0	0 1	1 3	EB EB	4	
2103160	210215	1549	HAYDEN	RD	FRANK LLOYD WRIGHT	BL	AT		1	0 0	7 1	4 1	WB NB	2	
2103371	210218	1509	HAYDEN	RD	FRANK LLOYD WRIGHT	BL	S	500	99	0 0	97 1	1 1	NB NB	6	
2104299	210304	1001	HAYDEN	RD	FRANK LLOYD WRIGHT	BL	AT		1	0 0	2 1	2 3	EB EB	4	
2104333	210304	1942	HAYDEN	RD	FRANK LLOYD WRIGHT	BL	S		1	0 0	12 1	8 1	SB SB	6	
2105001	210314	1254	HAYDEN	RD	FRANK LLOYD WRIGHT	BL	S	66	2	0	1 0	4	WB	1	
2105557	210321	1906	HAYDEN	RD	FRANK LLOYD WRIGHT	BL	AT		1	4 0	12 1	8 1	EB EB	6	
2107296	210415	1859	HAYDEN	RD	FRANK LLOYD WRIGHT	BL	AT		99	99 0	6 1	6 1	EB WB	3	
2107349	210416	1639	HAYDEN	RD	FRANK LLOYD WRIGHT	BL	E	130	3	4 0	2 1	1 2	EB EB	6	
2107652	210420	1439	HAYDEN	RD	FRANK LLOYD WRIGHT	BL	W	300	1	0 0	99 99	8 99	WB WB	6	
2107736	210421	2015	HAYDEN	RD	FRANK LLOYD WRIGHT	BL	AT		1	0 0	4 1	5 5	NB NB	4	
2108209	210428	1028	Hayden	RD	FRANK LLOYD WRIGHT	BL	AT		1	99 0	12 1	8 1	EB EB	6	
2109313	210512	1126	HAYDEN	RD	FRANK LLOYD WRIGHT	BL	S	575	2	0 0	20 1	1 1	WB NB	2	
2110812	210601	1150	HAYDEN	RD	FRANK LLOYD WRIGHT	BL	E	500	1	0 0	2 1	1 3	EB EB	4	
2110840	210601	1649	HAYDEN	RD	FRANK LLOYD WRIGHT	BL	S	227	1	99 0	97 1	1 3	WB NB	7	
2110843	210601	1658	HAYDEN	RD	FRANK LLOYD WRIGHT	BL			1	0 0	1 1	1 5	NB NB	2	
2112656	210628	1842	HAYDEN	RD	FRANK LLOYD WRIGHT	BL	W	600	1	0 0	12 1	8 1	WB WB	6	
2115181	210804	0947	HAYDEN	RD	FRANK LLOYD WRIGHT	BL	W	500	1	0 0	2 1	1 3	EB EB	4	
2115436	210807	0916	HAYDEN	RD	FRANK LLOYD WRIGHT	BL	W	100	1	0 0	2 1	1 2	EB EB	4	
2117497	210907	0656	HAYDEN	RD	FRANK LLOYD WRIGHT	BL			2	0 0	6 1	1 4	EB NW	2	
2118585	210923	0648	HAYDEN	RD	FRANK LLOYD WRIGHT	BL			1	0 0	97 1	6 5	WB NB	6	
2119496	211006	1158	HAYDEN	RD	FRANK LLOYD WRIGHT	BL	S	440	1	0 0	4 1	1 3	NB NB	4	
2120775	211024	1434	HAYDEN	RD	FRANK LLOYD WRIGHT	BL			1	0 99	1 7	1 5	NB NB	2	
2121081	211028	1634	HAYDEN	RD	FRANK LLOYD WRIGHT	BL			1	0 0	97 1	1 3	EB EB	4	
2122110	211111	1235	HAYDEN	RD	FRANK LLOYD WRIGHT	BL	E	75	1	0 0	1 1	1 1	EB EB	6	
2122552	211117	1440	HAYDEN	RD	FRANK LLOYD WRIGHT	BL	W	500	1	0 0	99 99	8 1	SE EB	6	
2122675	211119	1237	HAYDEN	RD	FRANK LLOYD WRIGHT	BL			3	99 0	6 1	1 3	WB EB	7	
2124249	211211	1345	HAYDEN	RD	FRANK LLOYD WRIGHT	BL	S	600	1	0 0	1	4 1	SB NB	3	
2124619	211216	1353	HAYDEN	RD	FRANK LLOYD WRIGHT	BL	W	450	1	0 0	12 1	8 1	EB EB	6	
2125104	211222	1425	HAYDEN	RD	FRANK LLOYD WRIGHT	BL			1	0 0	20 1	5 1	WB NB	7	
1900490	190108	1131	NORTHSIGHT	BL	FRANK LLOYD WRIGHT	BL	W	600	99	0 0	2 1	1 3	EB EB	4	
1901311	190118	1514	NORTHSIGHT	BL	FRANK LLOYD WRIGHT	BL	AT		1	0 0	1	4 1	SB EB	2	
1905049	190306	1140	NORTHSIGHT	BL	FRANK LLOYD WRIGHT	BL	E	440	1	0 0	97 1	1 3	EB EB	4	
1905485	190311	1735	NORTHSIGHT	BL	FRANK LLOYD WRIGHT	BL	AT		1	99 0	2 1	1 3	NB NB	4	

REPORT #	DATE YYMMDD	TIME HHMM	NORTH / SOUTH ST.	TYPE	EAST WEST ST.	TYPE	DIR FROM	DIST FROM	INJ. SEV.	PHYS. COND. #1 #2	VIOLATION #1 #2	ACTION #1 #2	TRAV. DIR. #1 #2	MANNER OF COLLISION	COMMENTS
1906816	190329	1524	NORTHSIGHT	BL	FRANK LLOYD WRIGHT	BL	W	360	3	0 0	2 1	1 3	EB EB	4	
1907380	190405	1411	NORTHSIGHT	BL	FRANK LLOYD WRIGHT	BL	E	200	2	0 0	2 1	1 3	EB EB	4	
1908486	190419	1716	NORTHSIGHT	BL	FRANK LLOYD WRIGHT	BL	AT		1	0 0	20 1	4 4	NB WB	2	
1915468	190723	1358	NORTHSIGHT	BL	FRANK LLOYD WRIGHT	BL	AT		1	0 0	97 1	10 3	SB NB	4	
1915838	190728	1509	NORTHSIGHT	BL	FRANK LLOYD WRIGHT	BL	E	500	1	0	2 0	4	NB	1	
1917697	190823	1602	NORTHSIGHT	BL	FRANK LLOYD WRIGHT	BL	AT		1	99 0	7 1	5 1	EB EB	4	
1920068	190924	1722	NORTHSIGHT	BL	FRANK LLOYD WRIGHT	BL	AT		1	4 0	97 1	1 1	EB EB	4	
1920375	190928	1732	NORTHSIGHT	BL	FRANK LLOYD WRIGHT	BL	W	656	1	0 0	2 1	1 2	EB EB	4	
1920752	191004	1052	NORTHSIGHT	BL	FRANK LLOYD WRIGHT	BL	E	300	1	99 0	2 1	1 3	EB EB	4	
1921131	191009	1714	NORTHSIGHT	BL	FRANK LLOYD WRIGHT	BL	AT		2	99 0	20 1	4 1	SB EB	3	
1922138	191023	1020	NORTHSIGHT	BL	FRANK LLOYD WRIGHT	BL	AT		1	99 0	12 1	8 1	WB WB	6	
1922211	191024	1229	NORTHSIGHT	BL	FRANK LLOYD WRIGHT	BL	W	880	1	0 0	2 1	1 3	EB EB	4	
1923213	191106	1347	NORTHSIGHT	BL	FRANK LLOYD WRIGHT	BL	AT		1	0 0	2 1	1 1	EB EB	4	
1927057	191231	1301	NORTHSIGHT	BL	FRANK LLOYD WRIGHT	BL	W	900	1	0 0	2 1	2 2	EB EB	4	
2000313	200105	1108	NORTHSIGHT	BL	FRANK LLOYD WRIGHT	BL	AT		1	0 0	12 1	8 99	WB WB	99	
2005313	200311	1201	NORTHSIGHT	BL	FRANK LLOYD WRIGHT	BL	W	255	1	0 0	12 1	8 1	WB WB	6	
2005379	200312	1241	NORTHSIGHT	BL	FRANK LLOYD WRIGHT	BL	SB	400	1	0 0	20 1	5 1	EB SB	2	
2005732	200317	1359	NORTHSIGHT	BL	FRANK LLOYD WRIGHT	BL	S	325	1	0 0	0 1	4 10	EB NB	6	
2011716	200710	1208	NORTHSIGHT	BL	FRANK LLOYD WRIGHT	BL	AT		1	0 0	2 1	1 2	EB EB	4	
2012386	200722	1705	NORTHSIGHT	BL	FRANK LLOYD WRIGHT	BL	AT		2	0 0	99 1	1 1	WB WB	4	
2014452	200827	1631	NORTHSIGHT	BL	FRANK LLOYD WRIGHT	BL	AT		1	0 0	20 1	4 1	WB EB	3	
2016759	201002	1857	NORTHSIGHT	BL	FRANK LLOYD WRIGHT	BL	E	200	1	0 0	12 1	8 1	WB WB	6	
2022285	201226	0429	NORTHSIGHT	BL	FRANK LLOYD WRIGHT	BL	AT		99	99	99 0	1	WB	1	
2102010	210130	1817	NORTHSIGHT	BL	FRANK LLOYD WRIGHT	BL	W	750	1	0 0	0 1	1 2	EB EB	4	
2102062	210131	1307	NORTHSIGHT	BL	FRANK LLOYD WRIGHT	BL	AT		1	0 0	20 1	4 1	SB EB	3	
2105032	210315	0026	NORTHSIGHT	BL	FRANK LLOYD WRIGHT	BL	W		1	3	99	1	WB	1	
2105904	210326	1225	NORTHSIGHT	BL	FRANK LLOYD WRIGHT	BL	W	200	1	0 0	2 1	1 3	EB EB	4	
2106220	210331	0830	NORTHSIGHT	BL	FRANK LLOYD WRIGHT	BL	AT		1	0 0	2 1	2 3	WB WB	4	
2106940	210410	1131	NORTHSIGHT	BL	FRANK LLOYD WRIGHT	BL	AT		1	0 0	97 1	6 1	WB WB	4	
2106959	210410	1644	NORTHSIGHT	BL	FRANK LLOYD WRIGHT	BL	W	931	2	0 0	8 1	1 2	EB EB	4	
2107650	210420	1417	NORTHSIGHT	BL	FRANK LLOYD WRIGHT	BL	AT		1	0	1 0		EB	1	
2113667	210713	1339	NORTHSIGHT	BL	FRANK LLOYD WRIGHT	BL	W	1000	1	0 0	2 1	1 3	EB EB	4	
2117226	210903	1141	NORTHSIGHT	BL	FRANK LLOYD WRIGHT	BL			1	0 0	97 1	1 3	EB EB	4	
2117765	210911	0111	NORTHSIGHT	BL	FRANK LLOYD WRIGHT	BL			1	5	13	1	EB	5	
2119606	211007	1433	NORTHSIGHT	BL	FRANK LLOYD WRIGHT	BL			1	0 0	2 1	1 3	EB EB	4	
2120634	211021	1258	NORTHSIGHT	BL	FRANK LLOYD WRIGHT	BL			1	99 0	2 1	1 3	EB EB	4	
2122501	211116	1556	NORTHSIGHT	BL	FRANK LLOYD WRIGHT	BL			1	0 0	12 1	8 1	EB EB	6	
2123343	211129	1457	NORTHSIGHT	BL	FRANK LLOYD WRIGHT	BL	W	0	1	0 0	2 1	2 3	EB EB	4	

REPORT #	DATE YYMMDD	TIME HHMM	NORTH / SOUTH ST.	TYPE	EAST WEST ST.	TYPE	DIR FROM	DIST FROM	INJ. SEV.	PHYS. COND. #1 #2	VIOLATION #1 #2	ACTION #1 #2	TRAV. DIR. #1 #2	MANNER OF COLLISION	COMMENTS
2123940	211207	1618	NORTHSIGHT	BL	FRANK LLOYD WRIGHT	BL			99	0 0	2 1	3 1	EB EB	4	
1909040	190426	1434	PROMENADE		FRANK LLOYD WRIGHT	BL	AT		3	0 0	0 1	1 3	EB EB	4	
1926771	191227	1254	PROMENADE		FRANK LLOYD WRIGHT	BL	AT		1	0 0	2 1	4 4	NB NB	5	
2002080	200128	1710	PROMENADE		FRANK LLOYD WRIGHT	BL	AT		1	0 0	2 1	1 1	EB EB	4	
2008686	200519	1808	PROMENADE		FRANK LLOYD WRIGHT	BL	E	559	1	0 0	2 1	1 14	EB EB	4	
2016752	201002	1750	PROMENADE		FRANK LLOYD WRIGHT	BL	E	500	1	0 0	2 1	4 4	WB WB	4	
2020411	201128	1744	PROMENADE		FRANK LLOYD WRIGHT	BL	AT		3	0 0	20 1	4 1	WB EB	3	
2105837	210325	1437	PROMENADE		FRANK LLOYD WRIGHT	BL	AT		1	0 0	7 1	5 1	NB WB	6	
2109053	210508	1810	PROMENADE		FRANK LLOYD WRIGHT	BL	W	80	2	0 0	4 1	1 2	WB WB	4	
2117999	210914	1542	PROMENADE		FRANK LLOYD WRIGHT	BL	W	200	1	0	1	1	EB	1	
1904168	190222	1608	SCOTTSDALE	RD	BELL	RD	N	1000	1	0 0	2 1	1 3	SB SB	4	
1904173	190222	1708	SCOTTSDALE	RD	BELL	RD	N	1200	2	0 0	2 99	1 1	SB SB	4	
1915967	190730	1616	SCOTTSDALE	RD	BELL	RD	N	300	1	99 0	4 1	1 3	SB SB	4	
1927077	191231	1812	SCOTTSDALE	RD	BELL	RD	AT		1	3 0	4 1	5 5	EB EB	4	
2000185	200103	1550	SCOTTSDALE	RD	BELL	RD	N	120	2	99 0	2 1	1 3	NB NB	4	
2020830	201204	1604	SCOTTSDALE	RD	BELL	RD	S	120	1	0 0	0 1	1 3	NB NB	4	
2115092	210802	1520	SCOTTSDALE	RD	BELL	RD			2	4 0	20 1	4 1	NB SB	3	
1901664	190123	0825	SCOTTSDALE	RD	FRANK LLOYD WRIGHT	BL	N	1230	4	0	97 0	5	EB	1	
1901763	190124	1444	SCOTTSDALE	RD	FRANK LLOYD WRIGHT	BL	AT		1	0 0	2 1	1 3	WB WB	4	
1902784	190204	1901	SCOTTSDALE	RD	FRANK LLOYD WRIGHT	BL	W	82	1	0 0	4 1	1 1	WB WB	4	
1903286	190211	1222	SCOTTSDALE	RD	FRANK LLOYD WRIGHT	BL	AT		1	0 0	3 1	1 3	EB EB	4	
1904047	190221	0736	SCOTTSDALE	RD	FRANK LLOYD WRIGHT	BL	N	1200	1	0 0	97 1	1 2	NB NB	4	
1904143	190222	1200	SCOTTSDALE	RD	FRANK LLOYD WRIGHT	BL	AT		1	0 0	2 1	2 3	SB SB	4	
1904608	190228	1508	SCOTTSDALE	RD	FRANK LLOYD WRIGHT	BL	AT		1	0 0	13 1	4 4	SB SB	7	
1905664	190314	1308	SCOTTSDALE	RD	FRANK LLOYD WRIGHT	BL	N	450	3	0 0	2 1	1 2	NB NB	4	
1909187	190428	1526	SCOTTSDALE	RD	FRANK LLOYD WRIGHT	BL	AT		1	0 0	97 1	2 3	NB NB	4	
1910181	190511	1556	SCOTTSDALE	RD	FRANK LLOYD WRIGHT	BL	N	50	1	0 0	2 1	1 3	SB SB	4	
1910443	190515	1211	SCOTTSDALE	RD	FRANK LLOYD WRIGHT	BL	AT		1	0 0	12 1	4 4	SB SB	6	
1911659	190531	1124	SCOTTSDALE	RD	FRANK LLOYD WRIGHT	BL	AT		1	0 0	2 1	1 3	NB NB	4	
1912001	190604	2040	SCOTTSDALE	RD	FRANK LLOYD WRIGHT	BL	S	100	2	0 0	2 1	1 3	NB NB	4	
1912100	190606	1229	SCOTTSDALE	RD	FRANK LLOYD WRIGHT	BL	S	450	1	0 0	4 1	1 3	NB NB	4	
1913669	190627	1130	SCOTTSDALE	RD	FRANK LLOYD WRIGHT	BL	AT		1	0 0	4 1	4 4	SB SB	4	
1914462	190708	1800	SCOTTSDALE	RD	FRANK LLOYD WRIGHT	BL	S	300	1	99 0	2 1	1 2	NB NB	4	
1914487	190709	0911	SCOTTSDALE	RD	FRANK LLOYD WRIGHT	BL	E	204	1	0	9 0	1	EB	97	
1914523	190709	1741	SCOTTSDALE	RD	FRANK LLOYD WRIGHT	BL	AT		1	0 0	4 1	1 99	WB WB	4	
1916324	190804	0926	SCOTTSDALE	RD	FRANK LLOYD WRIGHT	BL	AT		1	0 0	6 1	1 1	SB EB	2	
1916469	190806	1259	SCOTTSDALE	RD	FRANK LLOYD WRIGHT	BL	S	500	4	0 0	20 1	4 1	SB NB	3	
1916472	190806	1348	SCOTTSDALE	RD	FRANK LLOYD WRIGHT	BL	S	900	1	0 0	2 1	1 3	NB NB	4	

REPORT #	DATE YYMMDD	TIME HHMM	NORTH / SOUTH ST.	TYPE	EAST WEST ST.	TYPE	DIR FROM	DIST FROM	INJ. SEV.	PHYS. COND. #1 #2	VIOLATION #1 #2	ACTION #1 #2	TRAV. DIR. #1 #2	MANNER OF COLLISION	COMMENTS
1916575	190808	1357	SCOTTSDALE	RD	FRANK LLOYD WRIGHT	BL	S	1100	1	0 0	20 1	4 1	SB NB	3	
1916663	190809	1618	SCOTTSDALE	RD	FRANK LLOYD WRIGHT	BL	AT		1	0 0	2 1	1 3	WB WB	4	
1918002	190827	1807	SCOTTSDALE	RD	FRANK LLOYD WRIGHT	BL	S	200	1	99 0	12 1	8 2	NB NB	6	
1918627	190904	1434	SCOTTSDALE	RD	FRANK LLOYD WRIGHT	BL	S	200	2	0 0	2 1	1 3	NB NB	4	
1921804	191019	0024	SCOTTSDALE	RD	FRANK LLOYD WRIGHT	BL	AT		2	0 0	7 1	4 4	SB NB	2	
1922362	191026	1143	SCOTTSDALE	RD	FRANK LLOYD WRIGHT	BL	AT		1	0 0	2 1	1 1	NB NB	4	
1923631	191112	1835	SCOTTSDALE	RD	FRANK LLOYD WRIGHT	BL	E	15	1	0 0	2 1	1 1	WB WB	4	
1924675	191126	1657	SCOTTSDALE	RD	FRANK LLOYD WRIGHT	BL	N	100	1	0 0	2 1	1 3	SB SB	4	
1924734	191127	1612	SCOTTSDALE	RD	FRANK LLOYD WRIGHT	BL	N	675	2	0 0	0 7	4 1	EB NB	3	
1925113	191203	1753	SCOTTSDALE	RD	FRANK LLOYD WRIGHT	BL	AT		2	0 0	2 1	1 1	SB SB	4	
1925759	191212	1256	SCOTTSDALE	RD	FRANK LLOYD WRIGHT	BL	N	500	1	0 0	2 1	1 1	SB SB	4	
1925788	191212	1915	SCOTTSDALE	RD	FRANK LLOYD WRIGHT	BL	E	100	1	99 0	7 1	5 4	NB SB	6	
1926714	191226	1245	SCOTTSDALE	RD	FRANK LLOYD WRIGHT	BL	N	100	1	0 0	2 1	1 3	SB SB	4	
2000095	200102	1125	SCOTTSDALE	RD	FRANK LLOYD WRIGHT	BL	N	1000	1	0 0	99 99	4 4	SB SB	6	
2000692	200110	1653	SCOTTSDALE	RD	FRANK LLOYD WRIGHT	BL	AT		1	99 0	2 1	1 3	SB SB	4	
2001516	200121	1422	SCOTTSDALE	RD	FRANK LLOYD WRIGHT	BL	AT		1	0 0	7 1	5 4	NB NB	2	
2002644	200204	1822	SCOTTSDALE	RD	FRANK LLOYD WRIGHT	BL	N	800	1	0 0	97 1	1 3	SB SB	4	
2002856	200207	1612	SCOTTSDALE	RD	FRANK LLOYD WRIGHT	BL	AT		1	0 0	2 1	1 3	WB WB	4	
2003063	200210	1257	SCOTTSDALE	RD	FRANK LLOYD WRIGHT	BL	S	885	2	0 0	4 1	8 2	NB NB	4	
2003803	200220	1715	SCOTTSDALE	RD	FRANK LLOYD WRIGHT	BL	N	780	4	0 0	17 1	17 1	EB SB	97	
2004063	200224	0753	SCOTTSDALE	RD	FRANK LLOYD WRIGHT	BL	AT		1	99 0	12 1	8 1	EB EB	6	
2004639	200302	1413	SCOTTSDALE	RD	FRANK LLOYD WRIGHT	BL	AT		1	0 0	2 1	4 4	NB NB	4	
2005791	200318	1240	SCOTTSDALE	RD	FRANK LLOYD WRIGHT	BL	AT		1	0 0	1 1	5 4	NB NB	6	
2005999	200323	1619	SCOTTSDALE	RD	FRANK LLOYD WRIGHT	BL	AT		1	0	3 0	5	EB	1	
2008917	200523	1654	SCOTTSDALE	RD	FRANK LLOYD WRIGHT	BL	AT		1	0 0	7 1	5 4	NW NE	6	
2009118	200526	1727	SCOTTSDALE	RD	FRANK LLOYD WRIGHT	BL	AT		1	99 0	2 1	1 3	NB NB	4	
2009153	200527	0724	SCOTTSDALE	RD	FRANK LLOYD WRIGHT	BL	AT		1	0 0	12 1	97 1	SB SB	6	
2009295	200529	0723	SCOTTSDALE	RD	FRANK LLOYD WRIGHT	BL	AT		1	0 0	1 1	10 14	99 99	2	
2016104	200923	1241	SCOTTSDALE	RD	FRANK LLOYD WRIGHT	BL	AT		2	0 0	2 1	1 3	SW SW	4	
2018282	201026	0651	SCOTTSDALE	RD	FRANK LLOYD WRIGHT	BL	AT		3	0 0	2 1	1 3	SB NB	4	
2020408	201128	1757	SCOTTSDALE	RD	FRANK LLOYD WRIGHT	BL	AT		1	0 0	4 1	4 6	WB WB	3	
2021568	201214	1711	SCOTTSDALE	RD	FRANK LLOYD WRIGHT	BL	W	60	1	0 0	4 1	1 2	WB WB	4	
2100056	210101	2348	SCOTTSDALE	RD	FRANK LLOYD WRIGHT	BL	N	600	1	0	13 0	1	SB	1	
2101590	210124	1443	SCOTTSDALE	RD	FRANK LLOYD WRIGHT	BL	AT		2	0 0	2 1	5 3	NW SB	2	
2103660	210222	1611	SCOTTSDALE	RD	FRANK LLOYD WRIGHT	BL	S	653	2	0 0	2 1	1 3	NB NB	4	
2103720	210223	1426	SCOTTSDALE	RD	FRANK LLOYD WRIGHT	BL	N	560	2	0 0	97 1	1 1	SB SB	4	
2106253	210331	1602	SCOTTSDALE	RD	FRANK LLOYD WRIGHT	BL	E	500	1	0 0	2 1	1 1	EB EB	4	
2107134	210413	1047	SCOTTSDALE	RD	FRANK LLOYD WRIGHT	BL	AT		2	0 0	2 1	8 3	WB WB	4	

REPORT #	DATE YYMMDD	TIME HHMM	NORTH / SOUTH ST.	TYPE	EAST WEST ST.	TYPE	DIR FROM	DIST FROM	INJ. SEV.	PHYS. COND. #1 #2	VIOLATION #1 #2	ACTION #1 #2	TRAV. DIR. #1 #2	MANNER OF COLLISION	COMMENTS
2108168	210427	1326	SCOTTSDALE	RD	FRANK LLOYD WRIGHT	BL	AT		1	0 0	20 7	5 4	NB NB	3	
2108907	210506	1944	SCOTTSDALE	RD	FRANK LLOYD WRIGHT	BL	N	150	2	4 0	2	1 3	SB SB	4	
2109807	210519	1340	SCOTTSDALE	RD	FRANK LLOYD WRIGHT	BL			2	0 0	2 1	1 3	SB SB	4	
2111845	210616	2346	SCOTTSDALE	RD	FRANK LLOYD WRIGHT	BL			4	4 0	6 1	1 1	NB EB	2	
2111871	210617	1208	SCOTTSDALE	RD	FRANK LLOYD WRIGHT	BL	S	500	3	0 0	2 1	1 3	NB NB	4	
2112983	210703	2132	SCOTTSDALE	RD	FRANK LLOYD WRIGHT	BL			1	0 0	2 1	2 1	SB SB	4	
2113526	210711	1715	SCOTTSDALE	RD	FRANK LLOYD WRIGHT	BL	S	500	1	0 0	4 1	8 1	SB SB	2	
2113932	210716	2059	SCOTTSDALE	RD	FRANK LLOYD WRIGHT	BL	E	75	2	99 0	1	1 3	WB WB	4	
2114270	210721	1907	SCOTTSDALE	RD	FRANK LLOYD WRIGHT	BL			1	99 0	99 1	1 3	SB SB	4	
2115738	210812	0840	SCOTTSDALE	RD	FRANK LLOYD WRIGHT	BL			2	0 0	2 1	1 3	NB NB	4	
2115969	210815	1536	SCOTTSDALE	RD	FRANK LLOYD WRIGHT	BL			1	0 0	97 1	1 1	NB NB	4	
211661	210825	2149	SCOTTSDALE	RD	FRANK LLOYD WRIGHT	BL			2	4 0	2 1	1 3	WB WB	4	
2117169	210902	1400	SCOTTSDALE	RD	FRANK LLOYD WRIGHT	BL			3	0 0	6 1	1 4	EB NW	2	
2117594	210908	1439	SCOTTSDALE	RD	FRANK LLOYD WRIGHT	BL			1	0 0	4 1	4 4	NW NB	4	
2119106	210930	1348	SCOTTSDALE	RD	FRANK LLOYD WRIGHT	BL			1	0 0	6 1	1 4	WB NB	3	
2120136	211015	0946	SCOTTSDALE	RD	FRANK LLOYD WRIGHT	AV			1	0 0	20 1	5 1	EB SB	2	
2120776	211024	1441	SCOTTSDALE	RD	FRANK LLOYD WRIGHT	BL			1	0 0	2 1	1 1	NB NB	4	
2120982	211027	1308	SCOTTSDALE	RD	FRANK LLOYD WRIGHT	BL			1	0 0	2 1	1 3	WB WB	4	
2122317	211114	1128	SCOTTSDALE	RD	FRANK LLOYD WRIGHT	BL			1	0 0	6 1	1 1	EB NB	5	
2122970	211123	1515	SCOTTSDALE	RD	FRANK LLOYD WRIGHT	BL			2	0 0	6 1	1 1	SB WB	2	
1918850	190907	1058	SCOTTSDALE	RD	FRANK LLOYD WRIGHT	BL	AT		1	0 0	6 1	1 1	SB WB	3	

KEY

INJURY SEVERITY:

1=NO INJURY, 2=POSSIBLE INJURY, 3=NON-INCAPACITATING INJURY, 4=INCAPACITATING INJURY, 5=FATAL INJURY, 99=NOT REPORTED / UNKNOWN

PHYSICAL CONDITION:

0=NO APPARENT INFLUENCE, 1=ILLNESS, 2=PHYSICAL IMPAIRMENT, 3=FELL ASLEEP / FATIGUED 4=ALCOHOL, 5=DRUGS, 6=MEDICATIONS, A=NO TEST GIVEN, B=TEST GIVEN, C=TEST REFUSED, D=TESTING UNKNOWN, 97=OTHER, 99=UNKNOWN

VIOLATION:

1=NO IMPROPER ACTION, 2=SPEED TOO FAST FOR CONDITIONS, 3=EXCEEDED LAWFUL SPEED 4=FOLLOWED TOO CLOSELY. 5=RAN STOP SIGN, 6=DISREGARDED TRAFFIC SIGNAL 7=MADE IMPROPER TURN, 8=DROVE/RODE IN OPPOSING TRAFFIC LANE, 9=KNOWINGLY OPERATED WITH FAULTY / MISSING EQUIPMENT, 10=REQUIRED MOTORCYCLE SAFETY EQUIPMENT NOT USED, 11=PASSED IN NO PASSING ZONE, 12=UNSAFE LANE CHANGE, 13=FAILED TO KEEP IN PROPER LANE, 14=DISREGARDED PAVEMENT MARKINGS, 15=OTHER UNSAFE PASSING, 16=INATTENTION/DISTRACTION, 17=DID NOT USE CROSSWALK, 18=WALKED ON WRONG SIDE OF ROAD, 19=ELECTRONIC COMMUNICATIONS DEVICE, 20=FAILED TO YIELD RIGHT OF WAY (added August 2014), 97=OTHER, 99 UNKNOWN

ACTION:

1=GOING STRAIGHT AHEAD, 2=SLOWING IN TRAFFICWAY, 3=STOPPED IN TRAFFICWAY, 4=MAKING LEFT TURN, 5=MAKING RIGHT TURN, 6=MAKING U-TURN, 7=OVERTAKING/PASSING, 8=CHANGING LANES, 9=NEGOTIATING A CURVE, 10=BACKING, 11=AVOIDING VEH/OBJ/PED/CYCLIST/ANIMAL, 12=ENTERING PARKING POSITION, 13=LEAVING PARKING POSITION, 14=PROPERLY PARKED, 15=IMPROPERLY PARKED, 16=DRIVERLESS MOVING VEHICLE, 17=CROSSING ROAD, 18=WALKING WITH TRAFFIC, 19=WALKING AGAINST TRAFFIC, 20=STANDING, 21=LYING, 22=GETTING ON OR OFF VEHICLE, 23=WORKING ON/PUSHING VEHICLE, 24=WORKING ON ROAD, 97=OTHER, 99=UNKNOWN

MANNER OF COLLISION:

1=SINGLE VEHICLE, 2=ANGLE (front to side, other than left turn), 3=LEFT TURN, 4=REAR END (front to rear), 5=HEAD-ON (front to front, other than left turn), 6=SIDESWIPE (same direction), 7=SIDESWIPE (opposite direction), 8=REAR-TO-SIDE, 9=REAR TO REAR, 97=OTHER, 99=UNKNOWN

TOTAL 361

CITY OF SCOTTSDALE

COLLISION SUMMARY

REPORT #	DATE YYMMDD	TIME HHMM	NORTH / SOUTH ST.	TYPE	EAST WEST ST.	TYPE	DIR FROM	DIST FROM	INJ. SEV.	PHYS. COND. #1 #2	VIOLATION #1 #2	ACTION #1 #2	TRAV. DIR. #1 #2	MANNER OF COLLISION	COMMENTS
1900496	190108	1158	73	ST	GREENWAY HAYDEN	LP	AT		3	0 0	6 1	1 1	EB SB	2	
1905666	190314	1330	73	ST	GREENWAY HAYDEN	LP	AT		1	99 0	6 1	1 4	EB NB	3	
1908013	190413	1748	73	ST	GREENWAY HAYDEN	LP	AT		1	0 0	20 1	4 1	WB EB	3	
1911155	190524	1825	73	ST	GREENWAY HAYDEN	LP	AT		3	0 0	20 1	4 17	WB SB	1	
1919478	190916	1200	73	ST	GREENWAY HAYDEN	LP	AT		2	0 0	20 1	4 18	NB SB	1	
1919565	190917	1606	73	ST	GREENWAY HAYDEN	LP	AT		1	0 0	6 1	1 1	EB EB	4	
1924569	191125	1131	73	ST	GREENWAY HAYDEN	LP	W	503	1	0 0	7 1	8 1	EB EB	6	
2010335	200616	0700	73	ST	GREENWAY HAYDEN	LP	AT		2	0 0	6 1	1 1	SB EB	2	
2011246	200702	0730	73	ST	GREENWAY HAYDEN	LP	E	1000	1	0 0	2 1	1 2	WB WB	4	
2015871	200919	1843	73	ST	GREENWAY HAYDEN	LP	E	688	1	99	13 0	99	EB	1	
2017231	201010	1316	73	ST	GREENWAY HAYDEN	LP	AT		2	0 0	20 1	4 1	SW EB	3	
2018456	201028	1700	73	ST	GREENWAY HAYDEN	LP	AT		1	99 0	7 1	4 1	WB SB	3	
2015428	200911	2032	73	ST	GREENWAY-HAYDEN	LP	AT		1	0 0	20 1	4 1	WB EB	3	
2108885	210506	1410	73	ST	GREENWAY-HAYDEN				2	0 0	7 1	4 1	SW EB	2	
2124165	211210	1259	73	ST	GREENWAY-HAYDEN	LP	S	700	3	0 0	20 1	4 1	EB SB	2	
1909922	190508	1257	76	ST	GREENWAY HAYDEN	LP	AT		1	0 0	99 99	1 1	EB EB	4	
1922074	191022	1259	76	ST	GREENWAY HAYDEN	LP	AT		1	0 0	20 1	1 1	SB EB	2	
1924232	191120	1224	76	ST	GREENWAY HAYDEN	LP	AT		3	0 0	5 1	1 1	NB EB	2	
2002123	200129	1220	76	ST	GREENWAY HAYDEN	LP	AT		1	0 0	7 1	5 5	SB SB	6	
2010106	200612	1236	76	ST	GREENWAY HAYDEN	LP	AT		1	0 0	20 1	4 1	SB NB	2	
2010749	200623	0726	76	ST	GREENWAY HAYDEN	LP	W	45	1	0	99 0	1	WB	1	
2004073	200224	0941	76	ST	GREENWAY-HAYDEN	LP	AT		1	0 0	99 99	3 5	SB SB	6	
2103659	210222	1530	76	ST	GREENWAY-HAYDEN	LP	AT		1	0 0	6 1	4 1	SB WB	3	
2110399	210527	1413	76	ST	GREENWAY-HAYDEN				1	0 0	20 1	1 1	SB SB	2	
1905852	190316	2020	77	ST	GREENWAY HAYDEN	LP	AT		1	4	0 0	1	NB	1	
1921653	191017	0825	78	ST	GREENWAY HAYDEN	LP	AT		3	0 0	20 1	1 1	NB NB	2	
2013291	200807	1412	78	ST	GREENWAY HAYDEN	LP	AT		3	0 0	1 1	1 3	NE NB	2	
2124620	211216	1346	78	ST	GREENWAY-HAYDEN	LP			2	0 0	4 1	1 2	WB WB	4	
1907241	190404	0758	79	ST	GREENWAY HAYDEN	LP	AT		1	0 0	20 1	4 8	SB SB	2	
1921202	191010	1719	79	ST	GREENWAY HAYDEN	LP	AT		3	0 0	7 1	6 1	NB NB	3	
1913790	190628	1955	DIAL	BL	GREENWAY HAYDEN	LP	AT		1	99	0 99	6 1	WB SB	2	
2106801	210408	1228	DIAL	BL	GREENWAY-HAYDEN	LP	AT		1	0 0	12 1	8 1	NB NB	6	
2021622	201215	1616	GREENWAY HAYDEN	LP	DIAL	BL	AT		1	99 0	2 1	1 3	SB SB	6	
1900240	190104	1847	GREENWAY HAYDEN	LO	FRANK LLOYD WRIGHT	BL	AT		1	0 99	2 1	2 3	WB WB	4	HIT AND RUN
1900957	190113	2114	GREENWAY HAYDEN	LP	FRANK LLOYD WRIGHT	BL	E	800	1	4 0	8 1	6 1	EB WB	7	
1901026	190114	1833	GREENWAY HAYDEN	LP	FRANK LLOYD WRIGHT	BL	AT		1	0 0	1 1	1 1	WB WB	6	

REPORT #	DATE YYMMDD	TIME HHMM	NORTH / SOUTH ST.	TYPE	EAST WEST ST.	TYPE	DIR FROM	DIST FROM	INJ. SEV.	PHYS. COND. #1 #2	VIOLATION #1 #2	ACTION #1 #2	TRAV. DIR. #1 #2	MANNER OF COLLISION	COMMENTS
1901258	190117	2204	GREENWAY HAYDEN	LP	FRANK LLOYD WRIGHT	BL	AT		1	0 0	99 1	5 1	WB WB	2	
1901308	190118	1451	GREENWAY HAYDEN	LP	FRANK LLOYD WRIGHT	BL	W	200	1	0 0	12 1	8 1	EB EB	6	
1901762	190124	1426	GREENWAY HAYDEN	LP	FRANK LLOYD WRIGHT	BL	AT		1	0 0	12 1	8 1	SB SB	6	
1903550	190215	0745	GREENWAY HAYDEN	LP	FRANK LLOYD WRIGHT	BL	AT		1	0 0	12 1	8 1	EB EB	6	
1903839	190218	1304	GREENWAY HAYDEN	LP	FRANK LLOYD WRIGHT	BL	E	600	1	0 0	2 1	1 3	WB WB	4	
1903889	190219	0920	GREENWAY HAYDEN	LP	FRANK LLOYD WRIGHT	BL	W	100	1	99 0	97 1	1 4	EB EB	4	
1904061	190221	1241	GREENWAY HAYDEN	LP	FRANK LLOYD WRIGHT	BL	E	785	1	0	2 0	1	EB	1	
1904509	190227	0755	GREENWAY HAYDEN	LP	FRANK LLOYD WRIGHT	BL	W	500	1	0 0	2 1	1 3	EB EB	4	
1904935	190304	1748	GREENWAY HAYDEN	LP	FRANK LLOYD WRIGHT	BL	AT		1	0 0	2 1	1 5	WB WB	4	
1905667	190314	1330	GREENWAY HAYDEN	LP	FRANK LLOYD WRIGHT	BL	S	1100	1	0 0	0 99	1 1	NB NB	6	
1906315	190322	1510	GREENWAY HAYDEN	LP	FRANK LLOYD WRIGHT	BL	E	552	2	0 0	2 1	1 3	WB WB	4	
1907097	190402	1218	GREENWAY HAYDEN	LP	FRANK LLOYD WRIGHT	BL	E	245	1	0 0	97 1	10 1	WB WB	8	
1908894	190424	1546	GREENWAY HAYDEN	LP	FRANK LLOYD WRIGHT	BL	AT		1	0 0	2 1	8 3	WB WB	4	
1909404	190501	1605	GREENWAY HAYDEN	LP	FRANK LLOYD WRIGHT	BL	AT		1	0 0	2 1	1 1	SB SB	4	
1910107	190510	1615	GREENWAY HAYDEN	LP	FRANK LLOYD WRIGHT	BL	AT		1	0 0	2 1	2 3	WB WB	4	
1913665	190627	1021	GREENWAY HAYDEN	LP	FRANK LLOYD WRIGHT	BL	E	200	2	0 0	2 1	1 3	WB WB	4	
1913975	190701	1419	GREENWAY HAYDEN	LP	FRANK LLOYD WRIGHT	BL	AT		1	0 0	2 1	2 3	EB EB	4	
1914709	190712	1318	GREENWAY HAYDEN	LP	FRANK LLOYD WRIGHT	BL	E	500	1	99 0	97 1	1 3	NB NB	4	
1914967	190716	1332	GREENWAY HAYDEN	LP	FRANK LLOYD WRIGHT	BL	W	1000	1	0 0	2 1	2 3	EB EB	4	
1915593	190725	1219	GREENWAY HAYDEN	LP	FRANK LLOYD WRIGHT	BL	W	313	2	0 0	0 1	1 3	EB EB	4	
1916110	190801	1537	GREENWAY HAYDEN	LP	FRANK LLOYD WRIGHT	BL	E	60	1	0 0	97 1	1 3	EB EB	4	
1916391	190805	1248	GREENWAY HAYDEN	LP	FRANK LLOYD WRIGHT	BL	AT		1	0 0	2 1	1 3	EB EB	4	
1917008	190814	0702	GREENWAY HAYDEN	LP	FRANK LLOYD WRIGHT	BL	W	1000	1	0 0	12 1	8 1	WB WB	6	
1918298	190831	1141	GREENWAY HAYDEN	LP	FRANK LLOYD WRIGHT	BL	AT		1	0 0	4 4	1 1	WB WB	4	
1919187	190912	1803	GREENWAY HAYDEN	LP	FRANK LLOYD WRIGHT	BL	AT		1	0	1 0	1	WB	5	
1919637	190918	1642	GREENWAY HAYDEN	LP	FRANK LLOYD WRIGHT	BL	AT		1	0 0	2 1	1 3	EB EB	4	
1919750	190920	1224	GREENWAY HAYDEN	LP	FRANK LLOYD WRIGHT	BL	W	645	2	0 0	2 1	2 2	WB WB	4	
1919814	190921	1242	GREENWAY HAYDEN	LP	FRANK LLOYD WRIGHT	BL	AT		1	0 0	97 1	1 1	WB WB	4	
1920492	190930	1508	GREENWAY HAYDEN	LP	FRANK LLOYD WRIGHT	BL	AT		2	0 0	4 1	2 3	WB WB	4	
1921257	191011	1156	GREENWAY HAYDEN	LP	FRANK LLOYD WRIGHT	BL	E	500	1	0 0	2 1	1 3	WB WB	4	
1921931	191020	1543	GREENWAY HAYDEN	LP	FRANK LLOYD WRIGHT	BL	AT		1	0 0	13 13	1 1	EB EB	6	
1922171	191023	1833	GREENWAY HAYDEN	LP	FRANK LLOYD WRIGHT	BL	AT		1	0 0	13 1	1 1	EB EB	6	
1923127	191105	1036	GREENWAY HAYDEN	LP	FRANK LLOYD WRIGHT	BL	AT		1	0 0	1 1	1 1	EB EB	6	
1923832	191114	1721	GREENWAY HAYDEN	LP	FRANK LLOYD WRIGHT	BL	AT		1	0 0	4 1	1 2	SB SB	4	
1925003	191202	0808	GREENWAY HAYDEN	LP	FRANK LLOYD WRIGHT	BL	E	300	2	0 0	4 1	1 3	WB WB	4	
1925005	191202	0858	GREENWAY HAYDEN	LP	FRANK LLOYD WRIGHT	BL	E	300	1	0 0	4 1	1 3	WB WB	4	
1925021	191202	1123	GREENWAY HAYDEN	LP	FRANK LLOYD WRIGHT	BL	E	20	2	0 0	2 1	1 3	WB WB	4	
1925612	191210	0527	GREENWAY HAYDEN	LP	FRANK LLOYD WRIGHT	BL	AT		2	0 0	6 1	1 1	WB SB	2	

REPORT #	DATE YYMMDD	TIME HHMM	NORTH / SOUTH ST.	TYPE	EAST WEST ST.	TYPE	DIR FROM	DIST FROM	INJ. SEV.	PHYS. COND. #1 #2	VIOLATION #1 #2	ACTION #1 #2	TRAV. DIR. #1 #2	MANNER OF COLLISION	COMMENTS
1926959	191229	2124	GREENWAY HAYDEN	LP	FRANK LLOYD WRIGHT	BL	AT		1	99 0	7 1	6 4	EB EB	2	
2001177	200116	1745	GREENWAY HAYDEN	LP	FRANK LLOYD WRIGHT	BL	W	320	1	0 0	0 1	1 3	EB EB	4	
2001730	200124	1217	GREENWAY HAYDEN	LP	FRANK LLOYD WRIGHT	BL	AT		1	0 0	2 1	1 1	EB EB	4	
2002050	200128	1158	GREENWAY HAYDEN	LP	FRANK LLOYD WRIGHT	BL	N	300	1	0 0	2 1	1 3	NB NB	4	
2002297	200131	1416	GREENWAY HAYDEN	LP	FRANK LLOYD WRIGHT	BL	AT		1	99 0	2 1	4 4	WB WB	4	
2002646	200204	1911	GREENWAY HAYDEN	LP	FRANK LLOYD WRIGHT	BL	AT		1	0 0	7 1	5 1	NB EB	2	
2004704	200303	1252	GREENWAY HAYDEN	LP	FRANK LLOYD WRIGHT	BL	E	600	1	0 0	2 1	1 3	WB WB	4	
2005329	200311	1503	GREENWAY HAYDEN	LP	FRANK LLOYD WRIGHT	BL	AT		1	0 0	2 1	2 3	WB WB	4	
2010050	200611	1656	GREENWAY HAYDEN	LP	FRANK LLOYD WRIGHT	BL	E	100	1	0 0	4 1	1 3	WB WB	4	
2010093	200612	0818	GREENWAY HAYDEN	LP	FRANK LLOYD WRIGHT	BL	W	20	1	0 0	13 1	5 1	WB WB	2	
2012425	200723	1156	GREENWAY HAYDEN	LP	FRANK LLOYD WRIGHT	BL	AT		1	0 0	2 1	1 3	WB WB	4	
2014030	200820	1249	GREENWAY HAYDEN	LP	FRANK LLOYD WRIGHT	BL	AT		1	0 0	2 1	1 2	WB WB	4	
2014444	200827	1338	GREENWAY HAYDEN	LP	FRANK LLOYD WRIGHT	BL	AT		1	0 0	2 1	2 3	EB EB	4	
2014532	200828	1730	GREENWAY HAYDEN	LP	FRANK LLOYD WRIGHT	BL	E	200	1	99 0	12 1	8 3	WB WB	6	
2014982	200904	1825	GREENWAY HAYDEN	LP	FRANK LLOYD WRIGHT	BL	E	515	1	0 0	0 1	1 3	WB WB	4	
2015329	200910	1447	GREENWAY HAYDEN	LP	FRANK LLOYD WRIGHT	BL	AT		1	0 0	2 1	1 4	EB EB	4	
2018794	201102	1406	GREENWAY HAYDEN	LP	FRANK LLOYD WRIGHT	BL	AT		3	0 0	2 1	1 3	EB EB	4	
2018972	201105	1435	GREENWAY HAYDEN	LP	FRANK LLOYD WRIGHT	BL	W	10	1	0 0	0 1	8 3	EB EB	4	
2020596	201201	1502	GREENWAY HAYDEN	LP	FRANK LLOYD WRIGHT	BL	AT		1	0 0	7 1	1 8	WB WB	7	
2021004	201207	0757	GREENWAY HAYDEN	LP	FRANK LLOYD WRIGHT	BL	AT		1	0	7 0	5	EB	1	
1902248	190130	1206	GREENWAY HAYDEN	LP	PARADISE	LN	AT		1	0 0	20 1	4 1	WB NB	3	
1915560	190724	2025	GREENWAY HAYDEN	LP	PARADISE	LN	AT		3	0 0	2 1	4 4	EB EB	4	
1918207	190830	1146	GREENWAY HAYDEN	LP	PARADISE	LN	AT		3	0 0	10 1	4 1	WB NB	2	
1925855	191213	1517	GREENWAY HAYDEN	LP	PARADISE	LN	AT		2	0 0	20 1	1 1	EB NB	2	
2000404	200106	1632	GREENWAY HAYDEN	LP	PARADISE	LN	AT		1	0 0	2 1	5 3	WB EB	2	
2002318	200131	1912	GREENWAY-HAYDEN	LP	FRANK LLOYD WRIGHT	BL	AT		1	0 0	20 1	5 6	NB NB	2	
2003348	200214	1257	GREENWAY-HAYDEN	LP	FRANK LLOYD WRIGHT	BL	AT		1	0 0	2 1	1 3	EB EB	4	
2004648	200302	1520	GREENWAY-HAYDEN	LP	FRANK LLOYD WRIGHT	BL	W	739	2	0 0	4 1	1 3	WB WB	4	
2005188	200309	1256	GREENWAY-HAYDEN	LP	FRANK LLOYD WRIGHT	BL	AT		1	0 0	7 1	5 6	WB WB	2	
2005307	200311	1134	GREENWAY-HAYDEN	LP	FRANK LLOYD WRIGHT	BL	W	200	1	0 0	0 1	1 3	WB WB	4	
2012109	200717	1431	GREENWAY-HAYDEN	LP	FRANK LLOYD WRIGHT	BL	E	40	2	0 0	2 1	1 3	WB WB	4	
2013442	200810	0905	GREENWAY-HAYDEN	LP	FRANK LLOYD WRIGHT	BL	AT		2	0 0	6 1	1 4	WB NB	2	
2015462	200912	1259	GREENWAY-HAYDEN	LP	FRANK LLOYD WRIGHT	BL	AT		2	0 0	2 1	1 3	SB SB	4	
2100034	210101	1640	GREENWAY-HAYDEN	LP	FRANK LLOYD WRIGHT	BL	AT		1	0 0	20 1	5 1	SB EB	2	
2101926	210129	1636	GREENWAY-HAYDEN	LP	FRANK LLOYD WRIGHT	BL	W	250	1	0 0	4 1	1 3	EB EB	4	
2102680	210208	1700	GREENWAY-HAYDEN	LP	FRANK LLOYD WRIGHT	BL	AT		1	0 0	2 1	1 1	WB WB	4	
2104125	210301	1647	GREENWAY-HAYDEN	LP	FRANK LLOYD WRIGHT	BL	AT		1	0 0	2 1	1 1	WB WB	4	
2104298	210304	0957	GREENWAY-HAYDEN	LP	FRANK LLOYD WRIGHT	BL	AT		2	0 0	7 1	5 1	EB EB	2	

REPORT #	DATE YYMMDD	TIME HHMM	NORTH / SOUTH ST.	TYPE	EAST WEST ST.	TYPE	DIR FROM	DIST FROM	INJ. SEV.	PHYS. COND. #1 #2	VIOLATION #1 #2	ACTION #1 #2	TRAV. DIR. #1 #2	MANNER OF COLLISION	COMMENTS
2104672	210309	1122	GREENWAY-HAYDEN	LP	FRANK LLOYD WRIGHT	BL	W	500	1	0 0	2 1	1 3	EB EB	4	
2106474	210403	1640	GREENWAY-HAYDEN	LP	FRANK LLOYD WRIGHT	BL	AT		1	0 0	2 1	2 3	EB EB	4	
2107473	210418	0539	GREENWAY-HAYDEN	LP	FRANK LLOYD WRIGHT	BL	AT		1	0 0	6 1	1 1	EB NB	5	
2110899	210602	1707	GREENWAY-HAYDEN	LP	FRANK LLOYD WRIGHT	BL	S	15	1	0 0	4 1	1 3	NB NB	4	
2111272	210608	1335	GREENWAY-HAYDEN	LP	FRANK LLOYD WRIGHT	BL	E	200	3	0 0	2 1	1 1	WB WB	4	
2111726	210615	0926	GREENWAY-HAYDEN	LP	FRANK LLOYD WRIGHT	BL	E	256	1	3 0	2 1	1 1	EB EB	4	
2112307	210623	1423	GREENWAY-HAYDEN	LP	FRANK LLOYD WRIGHT	BL			1	0 0	13 1	4 3	SB NB	2	
2113757	210714	1604	GREENWAY-HAYDEN	LP	FRANK LLOYD WRIGHT	BL			1	0 0	97 1	1 3	WB WB	4	
2116245	210819	1557	GREENWAY-HAYDEN	LP	FRANK LLOYD WRIGHT	BL	W	200	2	0 0	4 1	1 3	EB EB	4	
2117083	210901	0836	GREENWAY-HAYDEN	LP	FRANK LLOYD WRIGHT	BL			1	0 0	4 1	1 4	SB SB	4	
2117170	210902	1426	GREENWAY-HAYDEN	LP	FRANK LLOYD WRIGHT	BL	N	0	2	0 0	2 1	1 2	SB SB	4	
2117864	210912	1521	GREENWAY-HAYDEN	LP	FRANK LLOYD WRIGHT	BL			1	0 0	6 1	1 4	SB EB	2	
2118268	210918	1033	GREENWAY-HAYDEN	LP	FRANK LLOYD WRIGHT	BL	W	15	1	99 0	4 1	99 2	WB WB	4	
2119097	210930	1158	GREENWAY-HAYDEN		FRANK LLOYD WRIGHT	BL	E	979	1	0 0	2 1	1 1	WB WB	4	
2121609	211104	1324	GREENWAY-HAYDEN	LP	FRANK LLOYD WRIGHT	BL			1	0 0	2 1	1 3	EB EB	4	
2122491	211116	1456	GREENWAY-HAYDEN	LP	FRANK LLOYD WRIGHT	BL	W	1479	3	0 0	97 1	17 5	WB NB	2	BIKE
2122538	211117	1216	GREENWAY-HAYDEN	LP	FRANK LLOYD WRIGHT	BL	W	200	3	4 0	2 1	1 1	WB WB	4	
2123705	211204	1244	GREENWAY-HAYDEN	LP	FRANK LLOYD WRIGHT	BL			1	0 0	2 1	1 1	WB WB	4	
2125456	211228	1514	GREENWAY-HAYDEN	LP	FRANK LLOYD WRIGHT	BL	W	600	1	0 0	2 1	1 3	WB WB	4	
2100446	210107	1515	GREENWAY-HAYDEN	LP	PARADISE	LN	AT		1	0 0	20 1	1 1	WB SB	2	
2100452	210107	1656	GREENWAY-HAYDEN	LP	PARADISE	LN	AT		1	0 0	7 1	4 1	EB NB	3	
2107724	210421	1653	GREENWAY-HAYDEN	LP	PARADISE	LN	S	150	1	0 0	7 1	4 1	SB SB	6	
2117172	210902	1509	GREENWAY-HAYDEN	LP	PARADISE	LN	N	150	2	0 0	2 1	1 2	SB SB	4	
2117174	210902	1548	GREENWAY-HAYDEN	LP	PARADISE	LN			3	0 0	20 1	1 1	WB SB	7	
2122938	211123	1151	GREENWAY-HAYDEN	LP	PARADISE	LN			1	99 0	20 1	1 1	WB NB	2	
2123920	211207	1328	GREENWAY-HAYDEN	LP	PARADISE	LN			1	0 0	7 1	5 1	SE SB	6	
1900358	190106	1920	SCOTTSDALE	RD	GREENWAY HAYDEN	LP	S	90	2	5 0	2 1	1 3	NB NB	4	MULTI VEH 3, DUI
1902331	190131	1040	SCOTTSDALE	RD	GREENWAY HAYDEN	LP	S	25	1	0 0	7 1	5 1	SB SB	2	
1905317	190309	1801	SCOTTSDALE	RD	GREENWAY HAYDEN	LP	AT		1	0 0	6 1	1 1	WB SB	2	
1905591	190313	1153	SCOTTSDALE	RD	GREENWAY HAYDEN	LP	N	240	1	0 0	1 1	1 3	SB SB	4	
1906913	190330	1428	SCOTTSDALE	RD	GREENWAY HAYDEN	LP	S	100	1	0 0	2 1	1 3	SB SB	4	
1907754	190410	1227	SCOTTSDALE	RD	GREENWAY HAYDEN	LP	N	150	1	0 0	2 1	1 3	SB SB	4	
1908144	190415	1401	SCOTTSDALE	RD	GREENWAY HAYDEN	LP	AT		1	0 0	2 1	1 3	SB SB	4	
1911398	190527	2227	SCOTTSDALE	RD	GREENWAY HAYDEN	LP	AT			99 0	99 1	99 14	99 SB	99	
1913045	190619	1240	SCOTTSDALE	RD	GREENWAY HAYDEN	LP	AT		1	99 0	2 1	1 3	SB SB	4	
1918564	190903	1609	SCOTTSDALE	RD	GREENWAY HAYDEN	LP	AT		1	0 0	4 4	1 1	SB SB	4	
1919437	190915	1938	SCOTTSDALE	RD	GREENWAY HAYDEN	LP	AT		1	0 0	6 1	1 4	NB SB	5	
1922868	191101	1937	SCOTTSDALE	RD	GREENWAY HAYDEN	LP	AT		2	99 0	0 1	1 2	NB NB	4	

REPORT #	DATE YYMMDD	TIME HHMM	NORTH / SOUTH ST.	TYPE	EAST WEST ST.	TYPE	DIR FROM	DIST FROM	INJ. SEV.	PHYS. COND. #1 #2	VIOLATION #1 #2	ACTION #1 #2	TRAV. DIR. #1 #2	MANNER OF COLLISION	COMMENTS
1924830	191129	2118	SCOTTSDALE	RD	GREENWAY HAYDEN	LP	AT		1	99 0	99 1	99 3	WB WB	4	
1926316	191219	1421	SCOTTSDALE	D	GREENWAY HAYDEN	LP	S	70	1	0 0	2 1	1 1	SB SB	4	
2001227	200117	1323	SCOTTSDALE	RD	GREENWAY HAYDEN	LP	S	200	1	0 0	2 1	1 1	NB NB	4	
2003151	200211	1629	SCOTTSDALE	RD	GREENWAY HAYDEN	LP	S	100	1	0 0	2 1	1 3	NB NB	4	
2006635	200408	1314	SCOTTSDALE	RD	GREENWAY HAYDEN	LP	N	405	1	0 0	12 1	8 1	NB NB	6	
2008550	200517	1421	SCOTTSDALE	RD	GREENWAY HAYDEN	LP	AT		1	0 0	2 1	1 3	SB SB	4	
2009921	200609	1206	SCOTTSDALE	RD	GREENWAY HAYDEN	LP	N	481	1	0 0	2 1	1 2	NB NB	4	
2013223	200806	1617	SCOTTSDALE	RD	GREENWAY HAYDEN	LP	AT		1	0 0	99 99	4 4	WB WB	3	
2016583	200930	1153	SCOTTSDALE	RD	GREENWAY HAYDEN	LP	AT		3	99 0	2 1	1 3	SB SB	4	
2017264	201010	2043	SCOTTSDALE	RD	GREENWAY HAYDEN	LP	AT		1	99 1	99 1	13 14	EB 99	6	
2017916	201020	2200	SCOTTSDALE	RD	GREENWAY HAYDEN	LP	AT		2	99 0	6 1	1 1	SB WB	2	
2018968	201105	1340	SCOTTSDALE	RD	GREENWAY HAYDEN	LP	AT		2	0 0	12 1	1 1	EB EB	6	
2022276	201225	1616	SCOTTSDALE	RD	GREENWAY HAYDEN	LP	AT		2	0 0	6 1	1 1	EB SB	2	
2003887	200221	1913	SCOTTSDALE	RD	GREENWAY-HAYDEN	LP	AT		1	0 0	4 1	1 1	SB SB	4	
2100229	210104	1227	SCOTTSDALE	RD	GREENWAY-HAYDEN	LP	N	1320	2	0 0	97 1	1 1	WB NB	2	
2101323	210120	2001	SCOTTSDALE	RD	GREENWAY-HAYDEN	LP	N	88	2	0 0	4 1	1 1	SB SB	4	
2104698	210309	1421	SCOTTSDALE	RD	GREENWAY-HAYDEN	LP	AT		1	0 0	6 1	1 1	NB WB	2	
2106314	210401	1452	SCOTTSDALE	RD	GREENWAY-HAYDEN	LP	S	277	1	0 0	12 1	6 1	SB SB	6	
2106477	210403	1751	SCOTTSDALE	RD	GREENWAY-HAYDEN	LP	AT		99	99 0	4 1	1 4	NB SB	3	
2113988	210717	1334	SCOTTSDALE	RD	GREENWAY-HAYDEN	LP			1	99 0	6 1	1 4	NB SB	2	
2115105	210802	1741	SCOTTSDALE	RD	GREENWAY-HAYDEN	LP		0	2	99 0	2 1	1 3	NB NB	4	
2120925	211026	1557	SCOTTSDALE	RD	GREENWAY-HAYDEN	LP			1	0 0	12 1	8 1	SB SB	6	
2121357	211101	1100	SCOTTSDALE	RD	GREENWAY-HAYDEN	LP	S	75	3	0 0	2 1	1 3	SB SB	4	
2125491	211229	1024	SCOTTSDALE	RD	GREENWAY-HAYDEN	LP			1	0 0	20 1	5 1	NB NB	2	

REPORT #	DATE	TIME	NORTH / SOUTH ST.	TYPE	EAST WEST ST.	TYPE	DIR	DIST	INJ. SEV.	PHYS. COND.	VIOLATION	ACTION	TRAV. DIR.	MANNER OF	COMMENTS
	YYMMDD	HHMM					FROM	FROM	#1	#2	#1	#2	#1	#2	COLLISION

KEY

INJURY SEVERITY:

1=NO INJURY, 2=POSSIBLE INJURY, 3=NON-INCAPACITATING INJURY, 4=INCAPACITATING INJURY, 5=FATAL INJURY, 99=NOT REPORTED / UNKNOWN

PHYSICAL CONDITION:

0=NO APPARENT INFLUENCE, 1=ILLNESS, 2=PHYSICAL IMPAIRMENT, 3=FELL ASLEEP / FATIGUED 4=ALCOHOL, 5=DRUGS, 6=MEDICATIONS, A=NO TEST GIVEN, B=TEST GIVEN, C=TEST REFUSED, D=TESTING UNKNOWN, 97=OTHER, 99=UNKNOWN

VIOLATION:

1=NO IMPROPER ACTION, 2=SPEED TOO FAST FOR CONDITIONS, 3=EXCEEDED LAWFUL SPEED 4=FOLLOWED TOO CLOSELY. 5=RAN STOP SIGN, 6=DISREGARDED TRAFFIC SIGNAL 7=MADE IMPROPER TURN, 8=DROVE/RODE IN OPPOSING TRAFFIC LANE, 9=KNOWINGLY OPERATED WITH FAULTY / MISSING EQUIPMENT, 10=REQUIRED MOTORCYCLE SAFETY EQUIPMENT NOT USED, 11=PASSED IN NO PASSING ZONE, 12=UNSAFE LANE CHANGE, 13=FAILED TO KEEP IN PROPER LANE, 14=DISREGARDED PAVEMENT MARKINGS, 15=OTHER UNSAFE PASSING, 16=INATTENTION/DISTRACTION, 17=DID NOT USE CROSSWALK, 18=WALKED ON WRONG SIDE OF ROAD, 19=ELECTRONIC COMMUNICATIONS DEVICE, 20=FAILED TO YIELD RIGHT OF WAY (added August 2014), 97=OTHER, 99 UNKNOWN

ACTION:

1=GOING STRAIGHT AHEAD, 2=SLOWING IN TRAFFICWAY, 3=STOPPED IN TRAFFICWAY, 4=MAKING LEFT TURN, 5=MAKING RIGHT TURN, 6=MAKING U-TURN, 7=OVERTAKING/PASSING, 8=CHANGING LANES, 9=NEGOTIATING A CURVE, 10=BACKING, 11=AVOIDING VEH/OBJ/PED/CYCLIST/ANIMAL, 12=ENTERING PARKING POSITION, 13=LEAVING PARKING POSITION, 14=PROPERLY PARKED, 15=IMPROPERLY PARKED, 16=DRIVERLESS MOVING VEHICLE, 17=CROSING ROAD, 18=WALKING WITH TRAFFIC, 19=WALKING AGAINST TRAFFIC, 20=STANDING, 21=LYING, 22=GETTING ON OR OFF VEHICLE, 23=WORKING ON/PUSHING VEHICLE, 24=WORKING ON ROAD, 97=OTHER, 99=UNKNOWN

MANNER OF COLLISION:

1=SINGLE VEHICLE, 2=ANGLE (front to side, other than left turn), 3=LEFT TURN, 4=REAR END (front to rear), 5=HEAD-ON (front to front, other than left turn), 6=SIDESWIPE (same direction), 7=SIDESWIPE (opposite direction), 8=REAR-TO-SIDE, 9=REAR TO REAR, 97=OTHER, 99=UNKNOWN

TOTAL 174

CITY OF SCOTTSDALE

COLLISION SUMMARY

REPORT #	DATE YYMMDD	TIME HHMM	NORTH / SOUTH ST.	TYPE	EAST WEST ST.	TYPE	DIR FROM	DIST FROM	INJ. SEV.	PHYS. COND. #1 #2	VIOLATION #1 #2	ACTION #1 #2	TRAV. DIR. #1 #2	MANNER OF COLLISION	COMMENTS
1914321	190706	1014	76	ST	PARADISE	LN	AT		1	0 0	97 99	1 4	SB EB	2	
2011203	200701	1340	76	ST	PARADISE	LN	AT		1	0 0	5 1	1 1	NB WB	2	
2017353	201012	1125	76	ST	PARADISE	LN	AT		1	0 0	5 1	1 1	WB SB	2	
2010111	200612	1336	77	ST	PARADISE	LN	E	50	1	0 0	20 1	4 1	NB EB	2	
2017988	201022	0658	77	ST	PARADISE	LN	AT		1	0 0	20 1	10 1	SB EB	97	
2018201	201024	2356	77	ST	PARADISE	DR	S	150	1	0	2 0	4	SB	1	
1915592	190725	1205	78	ST	PARADISE	LN	AT		2	0 0	99 99	1 1	WB SB	2	
2007882	200505	1521	78	ST	PARADISE	LN	S		1	0 0	0 1	1 1	SB WB	2	
1910841	190520	1122	DIAL	BL	PARADISE	LN	AT		1	0 0	97 1	10 1	EB EB	4	
1920958	191007	0709	DIAL	BL	PARADISE	LN	E	370	1	0 0	7 1	5 1	EB EB	2	
2021248	201210	1435	DIAL	BL	PARADISE	LN	AT		1	0	2 0	4	WB	3	
1902248	190130	1206	GREENWAY HAYDEN	LP	PARADISE	LN	AT		1	0 0	20 1	4 1	WB NB	3	
1915560	190724	2025	GREENWAY HAYDEN	LP	PARADISE	LN	AT		3	0 0	2 1	4 4	EB EB	4	
1918207	190830	1146	GREENWAY HAYDEN	LP	PARADISE	LN	AT		3	0 0	10 1	4 1	WB NB	2	
1925855	191213	1517	GREENWAY HAYDEN	LP	PARADISE	LN	AT		2	0 0	20 1	1 1	EB NB	2	
2000404	200106	1632	GREENWAY HAYDEN	LP	PARADISE	LN	AT		1	0 0	2 1	5 3	WB EB	2	
2100446	210107	1515	GREENWAY-HAYDEN	LP	PARADISE	LN	AT		1	0 0	20 1	1 1	WB SB	2	
2100452	210107	1656	GREENWAY-HAYDEN	LP	PARADISE	LN	AT		1	0 0	7 1	4 1	EB NB	3	
2107724	210421	1653	GREENWAY-HAYDEN	LP	PARADISE	LN	S	150	1	0 0	7 1	4 1	SB SB	6	
2117172	210902	1509	GREENWAY-HAYDEN	LP	PARADISE	LN	N	150	2	0 0	2 1	1 2	SB SB	4	
2117174	210902	1548	GREENWAY-HAYDEN	LP	PARADISE	LN			3	0 0	20 1	1 1	WB SB	7	
2122938	211123	1151	GREENWAY-HAYDEN	LP	PARADISE	LN			1	99 0	20 1	1 1	WB NB	2	
2123920	211207	1328	GREENWAY-HAYDEN	LP	PARADISE	LN			1	0 0	7 1	5 1	SE SB	6	
1902191	190129	1544	SCOTTSDALE	RD	PARADISE	LN	AT		1	0 0	0 1	1 3	NB NB	4	
1906972	190331	1223	SCOTTSDALE	RD	PARADISE	LN	S	2000	1	0 0	2 1	1 1	SB SB	4	
1909114	190427	1420	SCOTTSDALE	RD	PARADISE	LN	AT		4	0 0	2 1	1 1	SB EB	2	
1912711	190614	1513	SCOTTSDALE	RD	PARADISE	LN	AT		1	99 0	4 1	1 1	NB NB	4	
1913005	190618	2217	SCOTTSDALE	RD	PARADISE	LN	S	150	2	99 0	15 1	1 17	SB SB	6	
1918063	190828	1645	SCOTTSDALE	RD	PARADISE	LN	AT		1	0 0	99 99	1 1	SB SB	6	
1918481	190902	1711	SCOTTSDALE	RD	PARADISE	LN	AT		1	0 0	6 1	1 1	NB WB	2	
1919742	190920	0758	SCOTTSDALE	RD	PARADISE	LN	E	100	1	0 0	2 1	1 14	EB EB	4	
1923091	191104	1639	SCOTTSDALE	RD	PARADISE	LN	AT		1	0 99	7 1	4 1	SB NB	2	
1923594	191111	0826	SCOTTSDALE	RD	PARADISE	LN	AT		3	0 0	1 20	1 4	NB EB	3	
1925254	191205	1630	SCOTTSDALE	RD	PARADISE	LN	AT		1	0 0	12 12	4 5	NB NB	6	
2001024	200114	2032	SCOTTSDALE	RD	PARADISE	DR	AT		2	4	2 0	1	NB	1	
2004642	200302	1444	SCOTTSDALE	RD	PARADISE	LN	AT		1	0 0	97 1	10 3	WB WB	4	

REPORT #	DATE YYMMDD	TIME HHMM	NORTH / SOUTH ST.	TYPE	EAST WEST ST.	TYPE	DIR FROM	DIST FROM	INJ. SEV.	PHYS. COND. #1 #2	VIOLATION #1 #2	ACTION #1 #2	TRAV. DIR. #1 #2	MANNER OF COLLISION	COMMENTS
2005406	200312	2037	SCOTTSDALE	RD	PARADISE	LN	AT		1	0 0	12 1	8 1	SB SB	6	
2007432	200426	0328	SCOTTSDALE	RD	PARADISE	LN	AT		1	99	12 0	1	NB	1	
2010485	200618	1436	SCOTTSDALE	RD	PARADISE	LN	N	151	2	4 0	7 1	8 1	NB NB	6	
2104802	210311	1127	SCOTTSDALE	RD	PARADISE	LN	AT		1	0 0	2 1	1 3	SB SB	4	
2107786	210422	1433	SCOTTSDALE	RD	PARADISE	LN	N	530	2	0 0	20 1	1 1	EB SB	2	
2108973	210507	1540	SCOTTSDALE	RD	PARADISE	LN	N	50	1	0 0	20 1	5 8	WB NB	97	
2111652	210614	0836	SCOTTSDALE	RD	PARADISE	LN			2	0 0	6 1	1 1	NB EB	2	
2112224	210622	1230	SCOTTSDALE	RD	PARADISE	LN	S	460	1	0 0	2 1	1 3	NB NB	4	
2114397	210723	1348	SCOTTSDALE	RD	PARADISE	LN			1	0 0	12 1	5 1	NB NB	6	
2114677	210727	1243	SCOTTSDALE	RD	PARADISE	LN			1	0 0	13 1	5 1	SB SB	2	
2119610	211007	1508	SCOTTSDALE	RD	PARADISE	LN			1	0 0	2 1	1 3	NB NB	4	
2121684	211105	1545	SCOTTSDALE	RD	PARADISE	DR			1	99 0	2 1	1 3	B NB	4	

KEY

INJURY SEVERITY:

1=NO INJURY, 2=POSSIBLE INJURY, 3=NON-INCAPACITATING INJURY, 4=INCAPACITATING INJURY, 5=FATAL INJURY, 99=NOT REPORTED / UNKNOWN

PHYSICAL CONDITION:

0=NO APPARENT INFLUENCE, 1=ILLNESS, 2=PHYSICAL IMPAIRMENT, 3=FELL ASLEEP / FATIGUED 4=ALCOHOL, 5=DRUGS, 6=MEDICATIONS, A=NO TEST GIVEN, B=TEST GIVEN, C=TEST REFUSED, D=TESTING UNKNOWN, 97=OTHER, 99=UNKNOWN

VIOLATION:

1=NO IMPROPER ACTION, 2=SPEED TOO FAST FOR CONDITIONS, 3=EXCEEDED LAWFUL SPEED 4=FOLLOWED TOO CLOSELY. 5=RAN STOP SIGN, 6=DISREGARDED TRAFFIC SIGNAL 7=MADE IMPROPER TURN, 8=DROVE/RODE IN OPPOSING TRAFFIC LANE, 9=KNOWINGLY OPERATED WITH FAULTY / MISSING EQUIPMENT, 10=REQUIRED MOTORCYCLE SAFETY EQUIPMENT NOT USED, 11=PASSED IN NO PASSING ZONE, 12=UNSAFE LANE CHANGE, 13=FAILED TO KEEP IN PROPER LANE, 14=DISREGARDED PAVEMENT MARKINGS, 15=OTHER UNSAFE PASSING, 16=INATTENTION/DISTRACTION, 17=DID NOT USE CROSSWALK, 18=WALKED ON WRONG SIDE OF ROAD, 19=ELECTRONIC COMMUNICATIONS DEVICE, 20=FAILED TO YIELD RIGHT OF WAY (added August 2014), 97=OTHER, 99 UNKNOWN

ACTION:

1=GOING STRAIGHT AHEAD, 2=SLOWING IN TRAFFICWAY, 3=STOPPED IN TRAFFICWAY, 4=MAKING LEFT TURN, 5=MAKING RIGHT TURN, 6=MAKING U-TURN, 7=OVERTAKING/PASSING, 8=CHANGING LANES, 9=NEGOTIATING A CURVE, 10=BACKING, 11=AVOIDING VEH/OBJ/PED/CYCLIST/ANIMAL, 12=ENTERING PARKING POSITION, 13=LEAVING PARKING POSITION, 14=PROPERLY PARKED, 15=IMPROPERLY PARKED, 16=DRIVERLESS MOVING VEHICLE, 17=CROSSING ROAD, 18=WALKING WITH TRAFFIC, 19=WALKING AGAINST TRAFFIC, 20=STANDING, 21=LYING, 22=GETTING ON OR OFF VEHICLE, 23=WORKING ON/PUSHING VEHICLE, 24=WORKING ON ROAD, 97=OTHER, 99=UNKNOWN

MANNER OF COLLISION:

1=SINGLE VEHICLE, 2=ANGLE (front to side, other than left turn), 3=LEFT TURN, 4=REAR END (front to rear), 5=HEAD-ON (front to front, other than left turn), 6=SIDESWIPE (same direction), 7=SIDESWIPE (opposite direction), 8=REAR-TO-SIDE, 9=REAR TO REAR, 97=OTHER, 99=UNKNOWN

TOTAL 48

CITY OF SCOTTSDALE

COLLISION SUMMARY

REPORT #	DATE YYMMDD	TIME HHMM	NORTH / SOUTH ST.	TYPE	EAST WEST ST.	TYPE	DIR FROM	DIST FROM	INJ. SEV.	PHYS. COND. #1 #2	VIOLATION #1 #2	ACTION #1 #2	TRAV. DIR. #1 #2	MANNER OF COLLISION	COMMENTS
1904168	190222	1608	SCOTTSDALE	RD	BELL	RD	N	1000	1	0 0	2 1	1 3	SB SB	4	
1904173	190222	1708	SCOTTSDALE	RD	BELL	RD	N	1200	2	0 0	2 99	1 1	SB SB	4	
1915967	190730	1616	SCOTTSDALE	RD	BELL	RD	N	300	1	99 0	4 1	1 3	SB SB	4	
1927077	191231	1812	SCOTTSDALE	RD	BELL	RD	AT		1	3 0	4 1	5 5	EB EB	4	
2000185	200103	1550	SCOTTSDALE	RD	BELL	RD	N	120	2	99 0	2 1	1 3	NB NB	4	
2020830	201204	1604	SCOTTSDALE	RD	BELL	RD	S	120	1	0 0	0 1	1 3	NB NB	4	
2115092	210802	1520	SCOTTSDALE	RD	BELL	RD			2	4 0	20 1	4 1	NB SB	3	
1907528	190407	1131	SCOTTSDALE	RD	BUTHERUS	DR	N	493	2	5 0	2 1	1 3	NB NB	4	
1909523	190503	0708	SCOTTSDALE	RD	BUTHERUS	DR	AT		1	0 0	2 1	5 5	EB EB	4	
1910830	190520	0856	SCOTTSDALE	RD	BUTHERUS	DR	AT		1	99 0	2 1	5 3	NB NB	4	
1910856	190520	1436	SCOTTSDALE	RD	BUTHERUS	DR	S	75	1	0 0	2 1	1 3	NB NB	4	
1914481	190709	0712	SCOTTSDALE	RD	BUTHERUS	DR	AT		2	0 0	7 1	5 1	SB SB	2	
1917204	190816	1610	SCOTTSDALE	RD	BUTHERUS	DR	AT		99	99 0	99 1	99 14	NB NB	99	
1919959	190923	1330	SCOTTSDALE	RD	BUTHERUS	DR	N	50	1	0 0	12 1	8 1	NB NB	6	
1922827	191101	1235	SCOTTSDALE	RD	BUTHERUS	DR	N	100	1	0 0	1 1	2 3	SB SB	4	
1925486	191208	1339	SCOTTSDALE	RD	BUTHERUS	DR	S	320	1	0 0	12 1	8 1	NB NB	6	
2014420	200826	2030	SCOTTSDALE	RD	BUTHERUS		N	200	99	99 0	99 1	99 14	99 WB	99	
2016073	200922	2005	SCOTTSDALE	RD	BUTHERUS		N	220		99 0	97 1	10 14	EB WB	7	
2021490	201213	1552	SCOTTSDALE	RD	BUTHERUS	DR	AT		1	0 0	20 1	5 1	EB EB	2	
2103715	210223	1431	SCOTTSDALE	RD	BUTHERUS	DR	AT		2	0 0	2 1	1 3	SB SB	4	
2104838	210311	2135	SCOTTSDALE	RD	BUTHERUS	DR	AT		1	99 0	6 1	4 1	WB SB	3	
2108405	210430	1610	SCOTTSDALE	RD	BUTHERUS	DR	AT		1	99 0	3 1	1 3	SB SB	4	
2108739	210504	1843	SCOTTSDALE	RD	BUTHERUS	DR	N	450	1	0 0	97 1	1 3	NB NB	4	
2111887	210617	1633	SCOTTSDALE	RD	BUTHERUS	DR	N	110	2	4	13	99	SB	1	
2112913	210702	1715	SCOTTSDALE	RD	BUTHERUS	RD	N	200	1	0 0	12 1	8 1	SB SB	6	
2113426	210710	1055	SCOTTSDALE	RD	BUTHERUS	DR			1	0 0	12 1	8 1	NB NB	6	
2124745	211218	0234	SCOTTSDALE	RD	BUTHERUS	DR	E	20	1	4	2	1	EB EB	1	
2125595	211230	1900	SCOTTSDALE	RD	BUTHERUS	DR			3	0 0	6 1	1 4	EB WB	3	
1901664	190123	0825	SCOTTSDALE	RD	FRANK LLOYD WRIGHT	BL	N	1230	4	0	97 0	5	EB	1	
1901763	190124	1444	SCOTTSDALE	RD	FRANK LLOYD WRIGHT	BL	AT		1	0 0	2 1	1 3	WB WB	4	
1902784	190204	1901	SCOTTSDALE	RD	FRANK LLOYD WRIGHT	BL	W	82	1	0 0	4 1	1 1	WB WB	4	
1903286	190211	1222	SCOTTSDALE	RD	FRANK LLOYD WRIGHT	BL	AT		1	0 0	3 1	1 3	EB EB	4	
1904047	190221	0736	SCOTTSDALE	RD	FRANK LLOYD WRIGHT	BL	N	1200	1	0 0	97 1	1 2	NB NB	4	
1904143	190222	1200	SCOTTSDALE	RD	FRANK LLOYD WRIGHT	BL	AT		1	0 0	2 1	2 3	SB SB	4	
1904608	190228	1508	SCOTTSDALE	RD	FRANK LLOYD WRIGHT	BL	AT		1	0 0	13 1	4 4	SB SB	7	
1905664	190314	1308	SCOTTSDALE	RD	FRANK LLOYD WRIGHT	BL	N	450	3	0 0	2 1	1 2	NB NB	4	

REPORT #	DATE YYMMDD	TIME HHMM	NORTH / SOUTH ST.	TYPE	EAST WEST ST.	TYPE	DIR FROM	DIST FROM	INJ. SEV.	PHYS. COND. #1 #2	VIOLATION #1 #2	ACTION #1 #2	TRAV. DIR. #1 #2	MANNER OF COLLISION	COMMENTS
1909187	190428	1526	SCOTTSDALE	RD	FRANK LLOYD WRIGHT	BL	AT		1	0 0	97 1	2 3	NB NB	4	
1910181	190511	1556	SCOTTSDALE	RD	FRANK LLOYD WRIGHT	BL	N	50	1	0 0	2 1	1 3	SB SB	4	
1910443	190515	1211	SCOTTSDALE	RD	FRANK LLOYD WRIGHT	BL	AT		1	0 0	12 1	4 4	SB SB	6	
1911659	190531	1124	SCOTTSDALE	RD	FRANK LLOYD WRIGHT	BL	AT		1	0 0	2 1	1 3	NB NB	4	
1912001	190604	2040	SCOTTSDALE	RD	FRANK LLOYD WRIGHT	BL	S	100	2	0 0	2 1	1 3	NB NB	4	
1912100	190606	1229	SCOTTSDALE	RD	FRANK LLOYD WRIGHT	BL	S	450	1	0 0	4 1	1 3	NB NB	4	
1913669	190627	1130	SCOTTSDALE	RD	FRANK LLOYD WRIGHT	BL	AT		1	0 0	4 1	4 4	SB SB	4	
1914462	190708	1800	SCOTTSDALE	RD	FRANK LLOYD WRIGHT	BL	S	300	1	99 0	2 1	1 2	NB NB	4	
1914487	190709	0911	SCOTTSDALE	RD	FRANK LLOYD WRIGHT	BL	E	204	1	0	9 0	1	EB	97	
1914523	190709	1741	SCOTTSDALE	RD	FRANK LLOYD WRIGHT	BL	AT		1	0 0	4 1	1 99	WB WB	4	
1916324	190804	0926	SCOTTSDALE	RD	FRANK LLOYD WRIGHT	BL	AT		1	0 0	6 1	1 1	SB EB	2	
1916469	190806	1259	SCOTTSDALE	RD	FRANK LLOYD WRIGHT	BL	S	500	4	0 0	20 1	4 1	SB NB	3	
1916472	190806	1348	SCOTTSDALE	RD	FRANK LLOYD WRIGHT	BL	S	900	1	0 0	2 1	1 3	NB NB	4	
1916575	190808	1357	SCOTTSDALE	RD	FRANK LLOYD WRIGHT	BL	S	1100	1	0 0	20 1	4 1	SB NB	3	
1916663	190809	1618	SCOTTSDALE	RD	FRANK LLOYD WRIGHT	BL	AT		1	0 0	2 1	1 3	WB WB	4	
1918002	190827	1807	SCOTTSDALE	RD	FRANK LLOYD WRIGHT	BL	S	200	1	99 0	12 1	8 2	NB NB	6	
1918627	190904	1434	SCOTTSDALE	RD	FRANK LLOYD WRIGHT	BL	S	200	2	0 0	2 1	1 3	NB NB	4	
1921804	191019	0024	SCOTTSDALE	RD	FRANK LLOYD WRIGHT	BL	AT		2	0 0	7 1	4 4	SB NB	2	
1922362	191026	1143	SCOTTSDALE	RD	FRANK LLOYD WRIGHT	BL	AT		1	0 0	2 1	1 1	NB NB	4	
1923631	191112	1835	SCOTTSDALE	RD	FRANK LLOYD WRIGHT	BL	E	15	1	0 0	2 1	1 1	WB WB	4	
1924675	191126	1657	SCOTTSDALE	RD	FRANK LLOYD WRIGHT	BL	N	100	1	0 0	2 1	1 3	SB SB	4	
1924734	191127	1612	SCOTTSDALE	RD	FRANK LLOYD WRIGHT	BL	N	675	2	0 0	0 7	4 1	EB NB	3	
1925113	191203	1753	SCOTTSDALE	RD	FRANK LLOYD WRIGHT	BL	AT		2	0 0	2 1	1 1	SB SB	4	
1925759	191212	1256	SCOTTSDALE	RD	FRANK LLOYD WRIGHT	BL	N	500	1	0 0	2 1	1 1	SB SB	4	
1925788	191212	1915	SCOTTSDALE	RD	FRANK LLOYD WRIGHT	BL	E	100	1	99 0	7 1	5 4	NB SB	6	
1926714	191226	1245	SCOTTSDALE	RD	FRANK LLOYD WRIGHT	BL	N	100	1	0 0	2 1	1 3	SB SB	4	
2000095	200102	1125	SCOTTSDALE	RD	FRANK LLOYD WRIGHT	BL	N	1000	1	0 0	99 99	4 4	SB SB	6	
2000692	200110	1653	SCOTTSDALE	RD	FRANK LLOYD WRIGHT	BL	AT		1	99 0	2 1	1 3	SB SB	4	
2001516	200121	1422	SCOTTSDALE	RD	FRANK LLOYD WRIGHT	BL	AT		1	0 0	7 1	5 4	NB NB	2	
2002644	200204	1822	SCOTTSDALE	RD	FRANK LLOYD WRIGHT	BL	N	800	1	0 0	97 1	1 3	SB SB	4	
2002856	200207	1612	SCOTTSDALE	RD	FRANK LLOYD WRIGHT	BL	AT		1	0 0	2 1	1 3	WB WB	4	
2003063	200210	1257	SCOTTSDALE	RD	FRANK LLOYD WRIGHT	BL	S	885	2	0 0	4 1	8 2	NB NB	4	
2003803	200220	1715	SCOTTSDALE	RD	FRANK LLOYD WRIGHT	BL	N	780	4	0 0	17 1	17 1	EB SB	97	
2004063	200224	0753	SCOTTSDALE	RD	FRANK LLOYD WRIGHT	BL	AT		1	99 0	12 1	8 1	EB EB	6	
2004639	200302	1413	SCOTTSDALE	RD	FRANK LLOYD WRIGHT	BL	AT		1	0 0	2 1	4 4	NB NB	4	
2005791	200318	1240	SCOTTSDALE	RD	FRANK LLOYD WRIGHT	BL	AT		1	0 0	1 1	5 4	NB NB	6	
2005999	200323	1619	SCOTTSDALE	RD	FRANK LLOYD WRIGHT	BL	AT		1	0	3 0	5	EB	1	
2008917	200523	1654	SCOTTSDALE	RD	FRANK LLOYD WRIGHT	BL	AT		1	0 0	7 1	5 4	NW NE	6	

REPORT #	DATE YYMMDD	TIME HHMM	NORTH / SOUTH ST.	TYPE	EAST WEST ST.	TYPE	DIR FROM	DIST FROM	INJ. SEV.	PHYS. COND. #1 #2	VIOLATION #1 #2	ACTION #1 #2	TRAV. DIR. #1 #2	MANNER OF COLLISION	COMMENTS
2009118	200526	1727	SCOTTSDALE	RD	FRANK LLOYD WRIGHT	BL	AT		1	99 0	2 1	1 3	NB NB	4	
2009153	200527	0724	SCOTTSDALE	RD	FRANK LLOYD WRIGHT	BL	AT		1	0 0	12 1	97 1	SB SB	6	
2009295	200529	0723	SCOTTSDALE	RD	FRANK LLOYD WRIGHT	BL	AT		1	0 0	1 1	10 14	99 99	2	
2016104	200923	1241	SCOTTSDALE	RD	FRANK LLOYD WRIGHT	BL	AT		2	0 0	2 1	1 3	SW SW	4	
2018282	201026	0651	SCOTTSDALE	RD	FRANK LLOYD WRIGHT	BL	AT		3	0 0	2 1	1 3	SB NB	4	
2020408	201128	1757	SCOTTSDALE	RD	FRANK LLOYD WRIGHT	BL	AT		1	0 0	4 1	4 6	WB WB	3	
2021568	201214	1711	SCOTTSDALE	RD	FRANK LLOYD WRIGHT	BL	W	60	1	0 0	4 1	1 2	WB WB	4	
2100056	210101	2348	SCOTTSDALE	RD	FRANK LLOYD WRIGHT	BL	N	600	1	0	13 0	1	SB	1	
2101590	210124	1443	SCOTTSDALE	RD	FRANK LLOYD WRIGHT	BL	AT		2	0 0	2 1	5 3	NW SB	2	
2103660	210222	1611	SCOTTSDALE	RD	FRANK LLOYD WRIGHT	BL	S	653	2	0 0	2 1	1 3	NB NB	4	
2103720	210223	1426	SCOTTSDALE	RD	FRANK LLOYD WRIGHT	BL	N	560	2	0 0	97 1	1 1	SB SB	4	
2106253	210331	1602	SCOTTSDALE	RD	FRANK LLOYD WRIGHT	BL	E	500	1	0 0	2 1	1 1	EB EB	4	
2107134	210413	1047	SCOTTSDALE	RD	FRANK LLOYD WRIGHT	BL	AT		2	0 0	2 1	8 3	WB WB	4	
2108168	210427	1326	SCOTTSDALE	RD	FRANK LLOYD WRIGHT	BL	AT		1	0 0	20 7	5 4	NB NB	3	
2108907	210506	1944	SCOTTSDALE	RD	FRANK LLOYD WRIGHT	BL	N	150	2	4 0	2	1 3	SB SB	4	
2109807	210519	1340	SCOTTSDALE	RD	FRANK LLOYD WRIGHT	BL			2	0 0	2 1	1 3	SB SB	4	
2111845	210616	2346	SCOTTSDALE	RD	FRANK LLOYD WRIGHT	BL			4	4 0	6 1	1 1	NB EB	2	
2111871	210617	1208	SCOTTSDALE	RD	FRANK LLOYD WRIGHT	BL	S	500	3	0 0	2 1	1 3	NB NB	4	
2112983	210703	2132	SCOTTSDALE	RD	FRANK LLOYD WRIGHT	BL			1	0 0	2 1	2 1	SB SB	4	
2113526	210711	1715	SCOTTSDALE	RD	FRANK LLOYD WRIGHT	BL	S	500	1	0 0	4 1	8 1	SB SB	2	
2113932	210716	2059	SCOTTSDALE	RD	FRANK LLOYD WRIGHT	BL	E	75	2	99 0	1	1 3	WB WB	4	
2114270	210721	1907	SCOTTSDALE	RD	FRANK LLOYD WRIGHT	BL			1	99 0	99 1	1 3	SB SB	4	
2115738	210812	0840	SCOTTSDALE	RD	FRANK LLOYD WRIGHT	BL			2	0 0	2 1	1 3	NB NB	4	
2115969	210815	1536	SCOTTSDALE	RD	FRANK LLOYD WRIGHT	BL			1	0 0	97 1	1 1	NB NB	4	
211661	210825	2149	SCOTTSDALE	RD	FRANK LLOYD WRIGHT	BL			2	4 0	2 1	1 3	WB WB	4	
2117169	210902	1400	SCOTTSDALE	RD	FRANK LLOYD WRIGHT	BL			3	0 0	6 1	1 4	EB NW	2	
2117594	210908	1439	SCOTTSDALE	RD	FRANK LLOYD WRIGHT	BL			1	0 0	4 1	4 4	NW NB	4	
2119106	210930	1348	SCOTTSDALE	RD	FRANK LLOYD WRIGHT	BL			1	0 0	6 1	1 4	WB NB	3	
2120136	211015	0946	SCOTTSDALE	RD	FRANK LLOYD WRIGHT	AV			1	0 0	20 1	5 1	EB SB	2	
2120776	211024	1441	SCOTTSDALE	RD	FRANK LLOYD WRIGHT	BL			1	0 0	2 1	1 1	NB NB	4	
2120982	211027	1308	SCOTTSDALE	RD	FRANK LLOYD WRIGHT	BL			1	0 0	2 1	1 3	WB WB	4	
2122317	211114	1128	SCOTTSDALE	RD	FRANK LLOYD WRIGHT	BL			1	0 0	6 1	1 1	EB NB	5	
2122970	211123	1515	SCOTTSDALE	RD	FRANK LLOYD WRIGHT	BL			2	0 0	6 1	1 1	SB WB	2	
1918850	190907	1058	SCOTTSDALE	RD	FRANK LLOYD WRIGHT	BL	AT		1	0 0	6 1	1 1	SB WB	3	
1901849	190125	1501	SCOTTSDALE	RD	GREENWAY	PY	AT		1	0 0	20 1	8 1	WB WB	6	
2117096	210901	1158	SCOTTSDALE	RD	GREENWAY				1	0 0	1 1	1 1	NB NB	4	
2117388	210905	1550	SCOTTSDALE	RD	GREENWAY	RD			1	99 0	12 1	99 1	SB SB	4	
2122203	211112	2209	SCOTTSDALE	RD	GREENWAY	PY			2	0 0	99 99	4 1	NB SB	3	

REPORT #	DATE YYMMDD	TIME HHMM	NORTH / SOUTH ST.	TYPE	EAST WEST ST.	TYPE	DIR FROM	DIST FROM	INJ. SEV.	PHYS. COND. #1 #2	VIOLATION #1 #2	ACTION #1 #2	TRAV. DIR. #1 #2	MANNER OF COLLISION	COMMENTS
2124134	211209	2256	SCOTTSDALE	RD	GREENWAY	PY			2	0 0	99 99	1 1	SB WB	2	
1900358	190106	1920	SCOTTSDALE	RD	GREENWAY HAYDEN	LP	S	90	2	5 0	2 1	1 3	NB NB	4	MULTI VEH 3, DUI
1902331	190131	1040	SCOTTSDALE	RD	GREENWAY HAYDEN	LP	S	25	1	0 0	7 1	5 1	SB SB	2	
1905317	190309	1801	SCOTTSDALE	RD	GREENWAY HAYDEN	LP	AT		1	0 0	6 1	1 1	WB SB	2	
1905591	190313	1153	SCOTTSDALE	RD	GREENWAY HAYDEN	LP	N	240	1	0 0	1 1	1 3	SB SB	4	
1906913	190330	1428	SCOTTSDALE	RD	GREENWAY HAYDEN	LP	S	100	1	0 0	2 1	1 3	SB SB	4	
1907754	190410	1227	SCOTTSDALE	RD	GREENWAY HAYDEN	LP	N	150	1	0 0	2 1	1 3	SB SB	4	
1908144	190415	1401	SCOTTSDALE	RD	GREENWAY HAYDEN	LP	AT		1	0 0	2 1	1 3	SB SB	4	
1911398	190527	2227	SCOTTSDALE	RD	GREENWAY HAYDEN	LP	AT			99 0	99 1	99 14	99 SB	99	
1913045	190619	1240	SCOTTSDALE	RD	GREENWAY HAYDEN	LP	AT		1	99 0	2 1	1 3	SB SB	4	
1918564	190903	1609	SCOTTSDALE	RD	GREENWAY HAYDEN	LP	AT		1	0 0	4 4	1 1	SB SB	4	
1919437	190915	1938	SCOTTSDALE	RD	GREENWAY HAYDEN	LP	AT		1	0 0	6 1	1 4	NB SB	5	
1922868	191101	1937	SCOTTSDALE	RD	GREENWAY HAYDEN	LP	AT		2	99 0	0 1	1 2	NB NB	4	
1924830	191129	2118	SCOTTSDALE	RD	GREENWAY HAYDEN	LP	AT		1	99 0	99 1	99 3	WB WB	4	
1926316	191219	1421	SCOTTSDALE	D	GREENWAY HAYDEN	LP	S	70	1	0 0	2 1	1 1	SB SB	4	
2001227	200117	1323	SCOTTSDALE	RD	GREENWAY HAYDEN	LP	S	200	1	0 0	2 1	1 1	NB NB	4	
2003151	200211	1629	SCOTTSDALE	RD	GREENWAY HAYDEN	LP	S	100	1	0 0	2 1	1 3	NB NB	4	
2006635	200408	1314	SCOTTSDALE	RD	GREENWAY HAYDEN	LP	N	405	1	0 0	12 1	8 1	NB NB	6	
2008550	200517	1421	SCOTTSDALE	RD	GREENWAY HAYDEN	LP	AT		1	0 0	2 1	1 3	SB SB	4	
2009921	200609	1206	SCOTTSDALE	RD	GREENWAY HAYDEN	LP	N	481	1	0 0	2 1	1 2	NB NB	4	
2013223	200806	1617	SCOTTSDALE	RD	GREENWAY HAYDEN	LP	AT		1	0 0	99 99	4 4	WB WB	3	
2016583	200930	1153	SCOTTSDALE	RD	GREENWAY HAYDEN	LP	AT		3	99 0	2 1	1 3	SB SB	4	
2017264	201010	2043	SCOTTSDALE	RD	GREENWAY HAYDEN	LP	AT		1	99 1	99 1	13 14	EB 99	6	
2017916	201020	2200	SCOTTSDALE	RD	GREENWAY HAYDEN	LP	AT		2	99 0	6 1	1 1	SB WB	2	
2018968	201105	1340	SCOTTSDALE	RD	GREENWAY HAYDEN	LP	AT		2	0 0	12 1	1 1	EB EB	6	
2022276	201225	1616	SCOTTSDALE	RD	GREENWAY HAYDEN	LP	AT		2	0 0	6 1	1 1	EB SB	2	
2003887	200221	1913	SCOTTSDALE	RD	GREENWAY-HAYDEN	LP	AT		1	0 0	4 1	1 1	SB SB	4	
2100229	210104	1227	SCOTTSDALE	RD	GREENWAY-HAYDEN	LP	N	1320	2	0 0	97 1	1 1	WB NB	2	
2101323	210120	2001	SCOTTSDALE	RD	GREENWAY-HAYDEN	LP	N	88	2	0 0	4 1	1 1	SB SB	4	
2104698	210309	1421	SCOTTSDALE	RD	GREENWAY-HAYDEN	LP	AT		1	0 0	6 1	1 1	NB WB	2	
2106314	210401	1452	SCOTTSDALE	RD	GREENWAY-HAYDEN	LP	S	277	1	0 0	12 1	6 1	SB SB	6	
2106477	210403	1751	SCOTTSDALE	RD	GREENWAY-HAYDEN	LP	AT		99	99 0	4 1	1 4	NB SB	3	
2113988	210717	1334	SCOTTSDALE	RD	GREENWAY-HAYDEN	LP			1	99 0	6 1	1 4	NB SB	2	
2115105	210802	1741	SCOTTSDALE	RD	GREENWAY-HAYDEN	LP		0	2	99 0	2 1	1 3	NB NB	4	
2120925	211026	1557	SCOTTSDALE	RD	GREENWAY-HAYDEN	LP			1	0 0	12 1	8 1	SB SB	6	
2121357	211101	1100	SCOTTSDALE	RD	GREENWAY-HAYDEN	LP	S	75	3	0 0	2 1	1 3	SB SB	4	
2125491	211229	1024	SCOTTSDALE	RD	GREENWAY-HAYDEN	LP			1	0 0	20 1	5 1	NB NB	2	
2017400	201012	1911	SCOTTSDALE	RD	KIERLAND	BL	AT		1	0 0	6 1	1 6	NB SB	3	

REPORT #	DATE YYMMDD	TIME HHMM	NORTH / SOUTH ST.	TYPE	EAST WEST ST.	TYPE	DIR FROM	DIST FROM	INJ. SEV.	PHYS. COND. #1 #2	VIOLATION #1 #2	ACTION #1 #2	TRAV. DIR. #1 #2	MANNER OF COLLISION	COMMENTS
2017447	201013	1353	SCOTTSDALE	RD	KIERLAND	BL	AT		3	0	2 0	4	SB	1	
1902191	190129	1544	SCOTTSDALE	RD	PARADISE	LN	AT		1	0 0	0 1	1 3	NB NB	4	
1906972	190331	1223	SCOTTSDALE	RD	PARADISE	LN	S	2000	1	0 0	2 1	1 1	SB SB	4	
1909114	190427	1420	SCOTTSDALE	RD	PARADISE	LN	AT		4	0 0	2 1	1 1	SB EB	2	
1912711	190614	1513	SCOTTSDALE	RD	PARADISE	LN	AT		1	99 0	4 1	1 1	NB NB	4	
1913005	190618	2217	SCOTTSDALE	RD	PARADISE	LN	S	150	2	99 0	15 1	1 17	SB SB	6	
1918063	190828	1645	SCOTTSDALE	RD	PARADISE	LN	AT		1	0 0	99 99	1 1	SB SB	6	
1918481	190902	1711	SCOTTSDALE	RD	PARADISE	LN	AT		1	0 0	6 1	1 1	NB WB	2	
1919742	190920	0758	SCOTTSDALE	RD	PARADISE	LN	E	100	1	0 0	2 1	1 14	EB EB	4	
1923091	191104	1639	SCOTTSDALE	RD	PARADISE	LN	AT		1	0 99	7 1	4 1	SB NB	2	
1923594	191111	0826	SCOTTSDALE	RD	PARADISE	LN	AT		3	0 0	1 20	1 4	NB EB	3	
1925254	191205	1630	SCOTTSDALE	RD	PARADISE	LN	AT		1	0 0	12 12	4 5	NB NB	6	
2001024	200114	2032	SCOTTSDALE	RD	PARADISE	DR	AT		2	4	2 0	1	NB	1	
2004642	200302	1444	SCOTTSDALE	RD	PARADISE	LN	AT		1	0 0	97 1	10 3	WB WB	4	
2005406	200312	2037	SCOTTSDALE	RD	PARADISE	LN	AT		1	0 0	12 1	8 1	SB SB	6	
2007432	200426	0328	SCOTTSDALE	RD	PARADISE	LN	AT		1	99	12 0	1	NB	1	
2010485	200618	1436	SCOTTSDALE	RD	PARADISE	LN	N	151	2	4 0	7 1	8 1	NB NB	6	
2104802	210311	1127	SCOTTSDALE	RD	PARADISE	LN	AT		1	0 0	2 1	1 3	SB SB	4	
2107786	210422	1433	SCOTTSDALE	RD	PARADISE	LN	N	530	2	0 0	20 1	1 1	EB SB	2	
2108973	210507	1540	SCOTTSDALE	RD	PARADISE	LN	N	50	1	0 0	20 1	5 8	WB NB	97	
2111652	210614	0836	SCOTTSDALE	RD	PARADISE	LN			2	0 0	6 1	1 1	NB EB	2	
2112224	210622	1230	SCOTTSDALE	RD	PARADISE	LN	S	460	1	0 0	2 1	1 3	NB NB	4	
2114397	210723	1348	SCOTTSDALE	RD	PARADISE	LN			1	0 0	12 1	5 1	NB NB	6	
2114677	210727	1243	SCOTTSDALE	RD	PARADISE	LN			1	0 0	13 1	5 1	SB SB	2	
2119610	211007	1508	SCOTTSDALE	RD	PARADISE	LN			1	0 0	2 1	1 3	NB NB	4	
2121684	211105	1545	SCOTTSDALE	RD	PARADISE	DR			1	99 0	2 1	1 3	B NB	4	
1903476	190214	0625	SCOTTSDALE	RD	SANDRA	TE	E	106	1	0	7 0	4	SB	3	
1904111	190222	0045	SCOTTSDALE	RD	SANDRA	TE	S	50	2	4 0	2 1	1 14	SB SB	4	
1908899	190424	1745	SCOTTSDALE	RD	SANDRA	TE	AT		1	0 0	20 1	4 1	EB NB	3	
1915196	190719	1531	SCOTTSDALE	RD	SANDRA	TE	AT		1	0 0	97 1	1 3	NB WB	2	
2100222	210104	0952	SCOTTSDALE	RD	SANDRA	TE	AT		2	0 0	20 1	1 1	EB SB	2	
2100969	210115	1306	SCOTTSDALE	RD	SANDRA	TE	AT		1	0 0	20 1	4 1	EB SB	3	
2102273	210203	1442	SCOTTSDALE	RD	SANDRA	TE	AT		99	0 0	5 1	1 1	WB SB	2	
2113464	210710	1916	SCOTTSDALE	RD	SANDRA	TE			99	0 0	7 1	5 1	SB SB	6	
1924723	191127	1344	SCOTTSDALE	RD	SANDRA TERRACE		AT		1	0 0	2 1	1 1	NB NB	4	
2119526	211006	1551	SCOTTSDALE	RD	SANDRA TERRACE				1	99 99	99 99	8 1	NB NB	2	
1907523	190407	1038	SCOTTSDALE	RD	TIERRA BUENA	LN	S	50	2	0 0	12 1	8 1	SB SB	6	
1918756	190906	0637	SCOTTSDALE	RD	TIERRA BUENA	RD	S	230	1	0	2 0	5	NB	1	

REPORT #	DATE YYMMDD	TIME HHMM	NORTH / SOUTH ST.	TYPE	EAST WEST ST.	TYPE	DIR FROM	DIST FROM	INJ. SEV.	PHYS. COND. #1 #2	VIOLATION #1 #2	ACTION #1 #2	TRAV. DIR. #1 #2	MANNER OF COLLISION	COMMENTS
1926094	191216	1550	SCOTTSDALE	RD	TIERRA BUENA	LN	AT		1	0 0	20 1	4 1	SB NB	3	
2014330	200825	1114	SCOTTSDALE	RD	TIERRA BUENA	LN	AT		1	0 0	7 1	4 1	SB SB	3	

KEY

INJURY SEVERITY:

1=NO INJURY, 2=POSSIBLE INJURY, 3=NON-INCAPACITATING INJURY, 4=INCAPACITATING INJURY, 5=FATAL INJURY, 99=NOT REPORTED / UNKNOWN

PHYSICAL CONDITION:

0=NO APPARENT INFLUENCE, 1=ILLNESS, 2=PHYSICAL IMPAIRMENT, 3=FELL ASLEEP / FATIGUED 4=ALCOHOL, 5=DRUGS, 6=MEDICATIONS, A=NO TEST GIVEN, B=TEST GIVEN, C=TEST REFUSED, D=TESTING UNKNOWN, 97=OTHER, 99=UNKNOWN

VIOLATION:

1=NO IMPROPER ACTION, 2=SPEED TOO FAST FOR CONDITIONS, 3=EXCEEDED LAWFUL SPEED 4=FOLLOWED TOO CLOSELY. 5=RAN STOP SIGN, 6=DISREGARDED TRAFFIC SIGNAL 7=MADE IMPROPER TURN, 8=DROVE/RODE IN OPPOSING TRAFFIC LANE, 9=KNOWINGLY OPERATED WITH FAULTY / MISSING EQUIPMENT, 10=REQUIRED MOTORCYCLE SAFETY EQUIPMENT NOT USED, 11=PASSED IN NO PASSING ZONE, 12=UNSAFE LANE CHANGE, 13=FAILED TO KEEP IN PROPER LANE, 14=DISREGARDED PAVEMENT MARKINGS, 15=OTHER UNSAFE PASSING, 16=INATTENTION/DISTRACTION, 17=DID NOT USE CROSSWALK, 18=WALKED ON WRONG SIDE OF ROAD, 19=ELECTRONIC COMMUNICATIONS DEVICE, 20=FAILED TO YIELD RIGHT OF WAY (added August 2014), 97=OTHER, 99 UNKNOWN

ACTION:

1=GOING STRAIGHT AHEAD, 2=SLOWING IN TRAFFICWAY, 3=STOPPED IN TRAFFICWAY, 4=MAKING LEFT TURN, 5=MAKING RIGHT TURN, 6=MAKING U-TURN, 7=OVERTAKING/PASSING, 8=CHANGING LANES, 9=NEGOTIATING A CURVE, 10=BACKING, 11=AVOIDING VEH/OBJ/PED/CYCLIST/ANIMAL, 12=ENTERING PARKING POSITION, 13=LEAVING PARKING POSITION, 14=PROPERLY PARKED, 15=IMPROPERLY PARKED, 16=DRIVERLESS MOVING VEHICLE, 17=CROSING ROAD, 18=WALKING WITH TRAFFIC, 19=WALKING AGAINST TRAFFIC, 20=STANDING, 21=LYING, 22=GETTING ON OR OFF VEHICLE, 23=WORKING ON/PUSHING VEHICLE, 24=WORKING ON ROAD, 97=OTHER, 99=UNKNOWN

MANNER OF COLLISION:

1=SINGLE VEHICLE, 2=ANGLE (front to side, other than left turn), 3=LEFT TURN, 4=REAR END (front to rear), 5=HEAD-ON (front to front, other than left turn), 6=SIDESWIPE (same direction), 7=SIDESWIPE (opposite direction), 8=REAR-TO-SIDE, 9=REAR TO REAR, 97=OTHER, 99=UNKNOWN

TOTAL 190

CITY OF SCOTTSDALE

COLLISION SUMMARY

REPORT #	DATE YYMMDD	TIME HHMM	NORTH / SOUTH ST.	TYPE	EAST WEST ST.	TYPE	DIR FROM	DIST FROM	INJ. SEV.	PHYS. COND. #1 #2	VIOLATION #1 #2	ACTION #1 #2	TRAV. DIR. #1 #2	MANNER OF COLLISION	COMMENTS
1901322	190118	1705	DIAL	BL	TIERRA BUENA	LN	AT		1	0 0	99 99	1 1	WB NB	2	
1907523	190407	1038	SCOTTSDALE	RD	TIERRA BUENA	LN	S	50	2	0 0	12 1	8 1	SB SB	6	
1918756	190906	0637	SCOTTSDALE	RD	TIERRA BUENA	RD	S	230	1	0	2 0	5	NB	1	
1926094	191216	1550	SCOTTSDALE	RD	TIERRA BUENA	LN	AT		1	0 0	20 1	4 1	SB NB	3	
2014330	200825	1114	SCOTTSDALE	RD	TIERRA BUENA	LN	AT		1	0 0	7 1	4 1	SB SB	3	

KEY

INJURY SEVERITY:

1=NO INJURY, 2=POSSIBLE INJURY, 3=NON-INCAPACITATING INJURY, 4=INCAPACITATING INJURY, 5=FATAL INJURY, 99=NOT REPORTED / UNKNOWN

PHYSICAL CONDITION:

0=NO APPARENT INFLUENCE, 1=ILLNESS, 2=PHYSICAL IMPAIRMENT, 3=FELL ASLEEP / FATIGUED 4=ALCOHOL, 5=DRUGS, 6=MEDICATIONS, A=NO TEST GIVEN, B=TEST GIVEN, C=TEST REFUSED, D=TESTING UNKNOWN, 97=OTHER, 99=UNKNOWN

VIOLATION:

1=NO IMPROPER ACTION, 2=SPEED TOO FAST FOR CONDITIONS, 3=EXCEEDED LAWFUL SPEED 4=FOLLOWED TOO CLOSELY. 5=RAN STOP SIGN, 6=DISREGARDED TRAFFIC SIGNAL7=MADE IMPROPER TURN, 8=DROVE/RODE IN OPPOSING TRAFFIC LANE, 9=KNOWINGLY OPERATED WITH FAULTY / MISSING EQUIPMENT, 10=REQUIRED MOTORCYCLE SAFETY EQUIPMENT NOT USED, 11=PASSED IN NO PASSING ZONE, 12=UNSAFE LANE CHANGE, 13=FAILED TO KEEP IN PROPER LANE, 14=DISREGARDED PAVEMENT MARKINGS, 15=OTHER UNSAFE PASSING, 16=INATTENTION/DISTRACTION, 17=DID NOT USE CROSSWALK, 18=WALKED ON WRONG SIDE OF ROAD, 19=ELECTRONIC COMMUNICATIONS DEVICE, 20=FAILED TO YIELD RIGHT OF WAY (added August 2014), 97=OTHER, 99 UNKNOWN

ACTION:

1=GOING STRAIGHT AHEAD, 2=SLOWING IN TRAFFICWAY, 3=STOPPED IN TRAFFICWAY, 4=MAKING LEFT TURN, 5=MAKING RIGHT TURN, 6=MAKING U-TURN, 7=OVERTAKING/PASSING, 8=CHANGING LANES, 9=NEGOTIATING A CURVE, 10=BACKING, 11=AVOIDING VEH/OBJ/PED/CYCLIST/ANIMAL, 12=ENTERING PARKING POSITION, 13=LEAVING PARKING POSITION, 14=PROPERLY PARKED, 15=IMPROPERLY PARKED, 16=DRIVERLESS MOVING VEHICLE, 17=CROSING ROAD, 18=WALKING WITH TRAFFIC, 19=WALKING AGAINST TRAFFIC, 20=STANDING, 21=LYING, 22=GETTING ON OR OFF VEHICLE, 23=WORKING ON/PUSHING VEHICLE, 24=WORKING ON ROAD, 97=OTHER, 99=UNKNOWN

MANNER OF COLLISION:

1=SINGLE VEHICLE, 2=ANGLE (front to side, other than left turn), 3=LEFT TURN, 4=REAR END (front to rear), 5=HEAD-ON (front to front, other than left turn), 6=SIDESWIPE (same direction), 7=SIDESWIPE (opposite direction), 8=REAR-TO-SIDE, 9=REAR TO REAR, 97=OTHER, 99=UNKNOWN

TOTAL 5



Appendix C – Parcel Information

215-44-002F

Commercial Parcel

This is a Commercial parcel located at [16001 N SCOTTSDALE RD SCOTTSDALE 85254](#). The current owner is CRACKERJAX LAND COMPANY LLC. Its current year full cash value is \$15,576,700.

This parcel's appeal deadline date is: April 26th, 2022

MAPS	PICTOMETRY	VIEW/PAY TAX BILL	DEED
OWNER	VALUATIONS	ADDITIONAL INFO	MAP FERRET
SIMILAR PARCELS		REGISTER RENTAL	PRINT DETAILS

PROPERTY INFORMATION



[16001 N SCOTTSDALE RD SCOTTSDALE 85254](#)

MCR #

Description

TH PT N2 N2 SW4 SEC 2 LY W OF 73RD ST AS SHOWN ON MCR 259/38 EX W 65F & EX N 30F RD & EX RD PER MCR 259/38

Lat/Long

|

Lot Size

608,577 sq ft.

Zoning

C-4

Lot #

High School District

PARADISE VALLEY UNIFIED #69

Elementary School District

PARADISE VALLEY UNIFIED SCHOOL DISTRICT

Local Jurisdiction

SCOTTSDALE

S/T/R ?

2 3N 4E

Market

00/

Area/Neighborhood

Subdivision (0 Parcels)

OWNER INFORMATION



[CRACKERJAX LAND COMPANY LLC](#)

Mailing Address	4501 N SCOTTSDALE RD STE 201, SCOTTSDALE, AZ 85251 USA
In Care Of	STOCKDALE MANAGEMENT LLC
Deed Number	220347805
Last Deed Date	04/20/2022
Sale Date	n/a
Sale Price	n/a

VALUATION INFORMATION



We provide valuation information for the past 5 years. For mobile display, we only show 1 year of valuation information. Should you need more data, please look at our [data sales](#).

The Valuation Information displayed below may not reflect the taxable value used on the tax bill due to any special valuation relief program. [CLICK HERE TO PAY YOUR TAXES OR VIEW YOUR TAX BILL](#)

Tax Year	2023	2022	2021	2020	2019
Full Cash Value ⓘ	\$15,576,700	\$16,867,700	\$16,862,600	\$14,921,200	\$13,851,500
Limited Value ⓘ	\$7,360,092	\$7,009,611	\$6,675,820	\$6,357,924	\$6,055,166
Legal Class	M	M	M	M	M
Description	MIXED LEGAL CLASS	MIXED LEGAL CLASS	MIXED LEGAL CLASS	MIXED LEGAL CLASS	MIXED LEGAL CLASS
Assessment Ratio	16.2%	16.5%	16.8%	16.9%	16.9%
Assessed LPV	\$1,192,335	\$1,156,586	\$1,121,538	\$1,074,489	\$1,023,323
Property Use Code	2440	2440	2440	2440	2440
PU Description	Golf Driving Range	Golf Driving Range	Golf Driving Range	Golf Driving Range	Golf Driving Range
Tax Area Code	691400	691400	691400	691400	691400
Valuation Source	Notice	Notice	Notice	Notice	Notice

ADDITIONAL PROPERTY INFORMATION



Additional property data.

Description	Imp #	Occupancy	Rank	CCI	Age	Sq Ft.
Storage Warehouse	000101	406	2	B	29	6,600
Lt. Commercial Utility Build.	000201	471	2	C	29	504
Site Improvements	000301	163	2	D	29	1

MAP FERRET MAPS



Mapferret maps, also known as Mapld maps, pdf maps, or output maps are now available here without having to search.

▶ [Parcel Maps \(1\)](#)

▶ [Book/Map Maps \(1\)](#)

CAUTION! USERS SHOULD INDEPENDENTLY RESEARCH AND VERIFY INFORMATION ON THIS WEBSITE BEFORE RELYING ON IT.

The Assessor's Office has compiled information on this website that it uses to identify, classify, and value real and personal property. Please contact the Maricopa County S.T.A.R. Center at (602) 506-3406 if you believe any information is incomplete, out of date, or incorrect so that appropriate corrections can be addressed. Please note that a statutory process is also available to correct errors pursuant to Arizona Revised Statutes 42-16254.

The Assessor does not guarantee that any information provided on this website is accurate, complete, or current. In many instances, the Assessor has gathered information from independent sources and made it available on this site, and the original information may have contained errors and omissions. Errors and omissions may also have occurred in the process of gathering, interpreting, and reporting the information. Information on the website is not updated in "real time". In addition, users are cautioned that the process used on this site to illustrate the boundaries of the adjacent parcels is not always consistent with the recorded documents for such parcels. The parcel boundaries depicted on this site are for illustrative purposes only, and the exact relationship of adjacent parcels should be independently researched and verified. The information provided on this site is not the equivalent of a title report or a real estate survey. Users should independently research, investigate and verify all information before relying on it or in the preparation of legal documents.

By using this website, you acknowledge having read the above and waive any right you may have to claim against Maricopa County, its officers, employees, and contractors arising out of my reliance on or the use of the information provided on this website.

215-44-002D

Commercial Parcel

This is a Commercial parcel located at [16001 N SCOTTSDALE RD SCOTTSDALE 85254](#). The current owner is CRACKERJAX LAND COMPANY LLC. Its current year full cash value is \$17,267,300.

This parcel's appeal deadline date is: April 26th, 2022

- MAPS
- PICTOMETRY
- VIEW/PAY TAX BILL
- DEED
- OWNER
- VALUATIONS
- ADDITIONAL INFO
- SKETCHES
- MAP FERRET
- SIMILAR PARCELS
- REGISTER RENTAL
- PRINT DETAILS

PROPERTY INFORMATION



[16001 N SCOTTSDALE RD SCOTTSDALE 85254](#)

MCR

Description

TH PT S2 N2 SW4 SEC 2 LY W OF W R/W LN 73RD ST PER MCR 259/38 EX RDS PER MCR 259-38

Lat/Long

|

Lot Size

608,620 sq ft.

Zoning

C-4

Lot

High School District

PARADISE VALLEY UNIFIED #69

Elementary School District

PARADISE VALLEY UNIFIED SCHOOL DISTRICT

Local Jurisdiction

SCOTTSDALE

S/T/R ?

2 3N 4E

Market

00/

Area/Neighborhood

Subdivision (0 Parcels)

OWNER INFORMATION



[CRACKERJAX LAND COMPANY LLC](#)

Mailing Address	4501 N SCOTTSDALE RD STE 201, SCOTTSDALE, AZ 85251 USA
In Care Of	STOCKDALE MANAGEMENT LLC
Deed Number	220347806
Last Deed Date	04/20/2022
Sale Date	n/a
Sale Price	n/a

VALUATION INFORMATION



We provide valuation information for the past 5 years. For mobile display, we only show 1 year of valuation information. Should you need more data, please look at our [data sales](#).

The Valuation Information displayed below may not reflect the taxable value used on the tax bill due to any special valuation relief program. [CLICK HERE TO PAY YOUR TAXES OR VIEW YOUR TAX BILL](#)

Tax Year	2023	2022	2021	2020	2019
Full Cash Value ⓘ	\$17,267,300	\$18,407,100	\$18,417,800	\$16,484,100	\$15,399,700
Limited Value ⓘ	\$9,831,966	\$9,363,777	\$8,917,883	\$8,493,222	\$8,088,783
Legal Class	M	M	M	M	M
Description	MIXED LEGAL CLASS	MIXED LEGAL CLASS	MIXED LEGAL CLASS	MIXED LEGAL CLASS	MIXED LEGAL CLASS
Assessment Ratio	16.3%	16.6%	16.9%	17.0%	17.0%
Assessed LPV	\$1,602,610	\$1,554,387	\$1,507,122	\$1,443,848	\$1,375,093
Property Use Code	2570	2570	2570	2570	2570
PU Description	Amusement Facility	Amusement Facility	Amusement Facility	Amusement Facility	Amusement Facility
Tax Area Code	691400	691400	691400	691400	691400
Valuation Source	Notice	Notice	Notice	Notice	Notice

ADDITIONAL PROPERTY INFORMATION



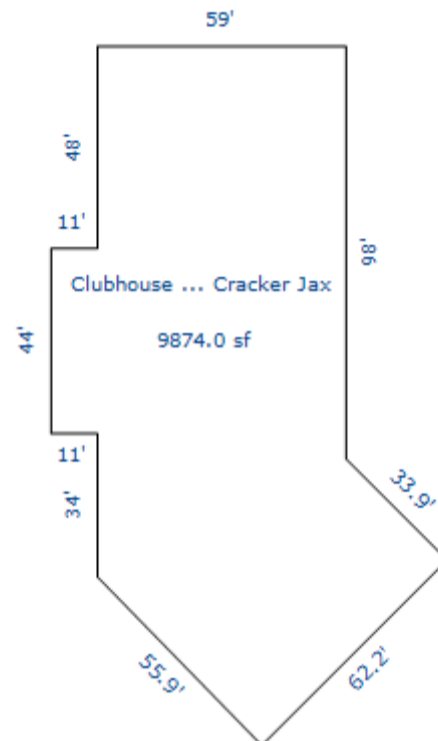
Additional property data.

Description	Imp #	Occupancy	Rank	CCI	Age	Sq Ft.
Clubhouse	000101	311	2	C	29	9,837
Lt. Commercial Utility Build.	000201	471	2	C	29	800
Lt. Commercial Utility Build.	000301	471	2	C	29	448
Lt. Commercial Utility Build.	000401	471	2	C	29	244
Site Improvements	000601	163	2	D	29	1

BUILDING SKETCHES



Sketches that illustrate the external dimensions of a property.



MAP FERRET MAPS



Mapferret maps, also known as Mapld maps, pdf maps, or output maps are now available here without having to search.

▶ [Parcel Maps \(1\)](#)

▶ [Book/Map Maps \(1\)](#)

CAUTION! USERS SHOULD INDEPENDENTLY RESEARCH AND VERIFY INFORMATION ON THIS WEBSITE BEFORE RELYING ON IT.

The Assessor's Office has compiled information on this website that it uses to identify, classify, and value real and personal property. Please contact the Maricopa County S.T.A.R. Center at (602) 506-3406 if you believe any information is incomplete, out of date, or incorrect so that appropriate corrections can be addressed. Please note that a statutory process is also available to correct errors pursuant to Arizona Revised Statutes 42-16254.

The Assessor does not guarantee that any information provided on this website is accurate, complete, or current. In many instances, the Assessor has gathered information from independent sources and made it available on this site, and the original information may have contained errors and omissions. Errors and omissions may also have occurred in the process of gathering, interpreting, and reporting the information. Information on the website is not updated in "real time". In addition, users are cautioned that the process used on this site to illustrate the boundaries of the adjacent parcels is not always consistent with the

recorded documents for such parcels. The parcel boundaries depicted on this site are for illustrative purposes only, and the exact relationship of adjacent parcels should be independently researched and verified. The information provided on this site is not the equivalent of a title report or a real estate survey. Users should independently research, investigate and verify all information before relying on it or in the preparation of legal documents.

By using this website, you acknowledge having read the above and waive any right you may have to claim against Maricopa County, its officers, employees, and contractors arising out of my reliance on or the use of the information provided on this website.



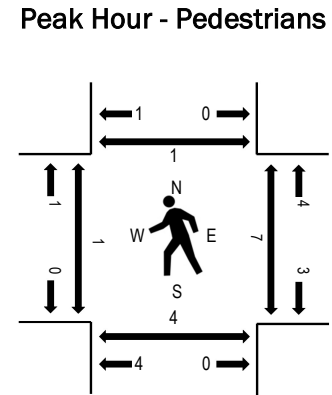
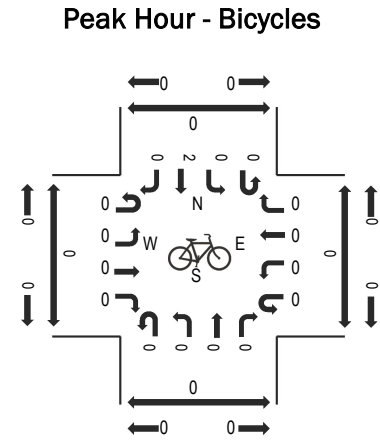
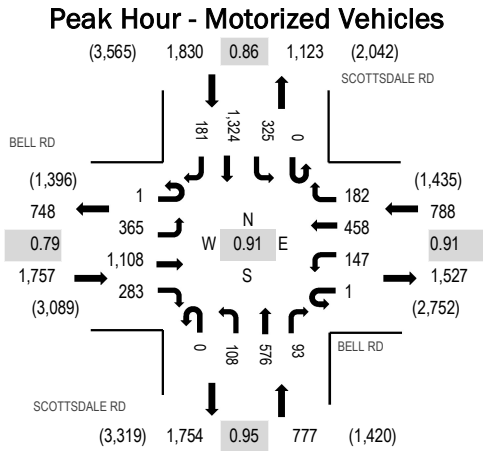
Appendix D – Traffic Count Data

Location: 1 SCOTTSDALE RD & BELL RD AM

Date: Tuesday, May 10, 2022

Peak Hour: 07:30 AM - 08:30 AM

Peak 15-Minutes: 07:45 AM - 08:00 AM

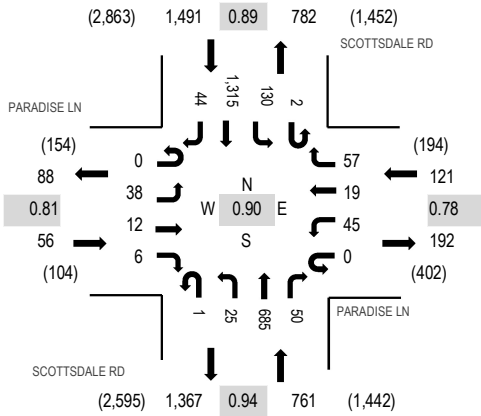


Note: Total study counts contained in parentheses.

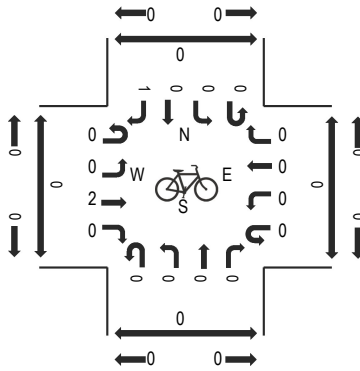
Traffic Counts - Motorized Vehicles

Interval Start Time	BELL RD Eastbound				BELL RD Westbound				SCOTTSDALE RD Northbound				SCOTTSDALE RD Southbound				Total	Rolling Hour	Pedestrian Crossings			
	U-Turn	Left	Thru	Right	U-Turn	Left	Thru	Right	U-Turn	Left	Thru	Right	U-Turn	Left	Thru	Right			West	East	South	North
7:00 AM	0	50	193	37	1	22	64	29	0	16	97	9	0	68	230	56	872	4,762	1	0	0	1
7:15 AM	0	63	237	68	0	22	113	28	1	25	108	16	0	69	277	71	1,098	5,141	0	1	1	0
7:30 AM	0	90	283	68	0	31	138	43	0	14	150	23	0	84	390	65	1,379	5,152	1	2	3	0
7:45 AM	0	110	357	88	1	40	131	45	0	43	141	23	0	81	318	35	1,413	4,952	0	1	0	1
8:00 AM	1	73	249	69	0	41	101	49	0	28	151	22	0	91	341	35	1,251	4,747	0	3	1	0
8:15 AM	0	92	219	58	0	35	88	45	0	23	134	25	0	69	275	46	1,109		0	1	0	0
8:30 AM	0	76	192	60	0	35	85	47	0	19	148	26	0	93	359	39	1,179		0	4	0	0
8:45 AM	0	88	204	64	0	45	88	68	0	29	117	32	0	85	345	43	1,208		0	1	1	0
Count Total	1	642	1,934	512	2	271	808	354	1	197	1,046	176	0	640	2,535	390	9,509		2	13	6	2
Peak Hour	1	365	1,108	283	1	147	458	182	0	108	576	93	0	325	1,324	181	5,152		1	7	4	1

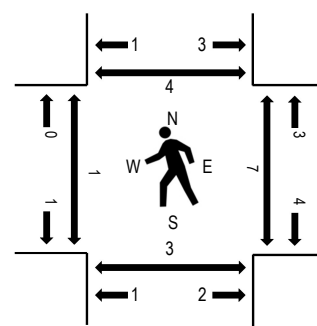
Peak Hour - Motorized Vehicles



Peak Hour - Bicycles



Peak Hour - Pedestrians

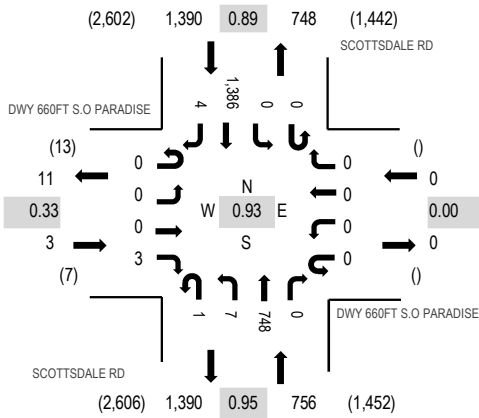


Note: Total study counts contained in parentheses.

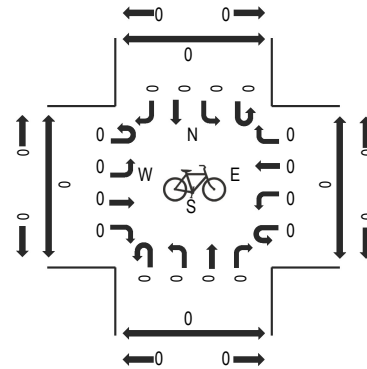
Traffic Counts - Motorized Vehicles

Interval Start Time	PARADISE LN Eastbound				PARADISE LN Westbound				SCOTTSDALE RD Northbound				SCOTTSDALE RD Southbound				Total	Rolling Hour	Pedestrian Crossings			
	U-Turn	Left	Thru	Right	U-Turn	Left	Thru	Right	U-Turn	Left	Thru	Right	U-Turn	Left	Thru	Right			West	East	South	North
7:00 AM	0	8	1	0	0	0	2	7	0	4	108	14	0	21	192	9	366	2,212	0	0	2	0
7:15 AM	0	4	2	1	0	10	0	6	0	4	158	12	1	53	303	5	559	2,427	1	1	1	0
7:30 AM	0	15	2	1	0	6	2	10	0	7	169	17	0	44	331	11	615	2,426	0	1	0	0
7:45 AM	0	8	3	1	0	13	4	16	0	8	183	12	2	53	354	15	672	2,429	0	2	0	1
8:00 AM	0	15	3	0	0	12	5	14	1	6	164	16	0	28	305	12	581	2,391	1	1	3	2
8:15 AM	0	5	2	1	0	6	1	11	0	3	168	12	0	23	316	10	558		0	3	0	1
8:30 AM	0	10	4	4	0	14	9	16	0	8	170	10	0	26	340	7	618		0	1	0	0
8:45 AM	0	9	2	3	0	14	3	13	0	8	162	18	0	24	367	11	634		0	1	0	1
Count Total	0	74	19	11	0	75	26	93	1	48	1,282	111	3	272	2,508	80	4,603		2	10	6	5
Peak Hour	0	38	12	6	0	45	19	57	1	25	685	50	2	130	1,315	44	2,429		1	7	3	4

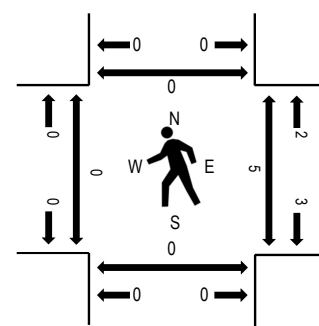
Peak Hour - Motorized Vehicles



Peak Hour - Bicycles



Peak Hour - Pedestrians

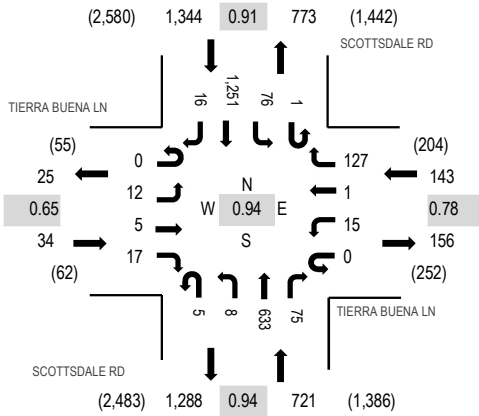


Note: Total study counts contained in parentheses.

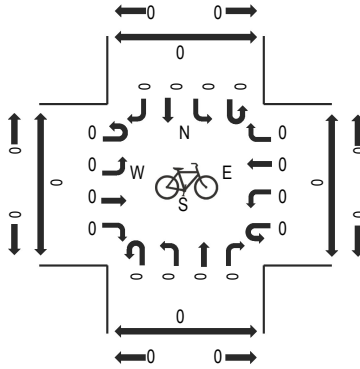
Traffic Counts - Motorized Vehicles

Interval Start Time	DWY 660FT S.O PARADISE Eastbound				DWY 660FT S.O PARADISE Westbound				SCOTTSDALE RD Northbound				SCOTTSDALE RD Southbound				Total	Rolling Hour	Pedestrian Crossings			
	U-Turn	Left	Thru	Right	U-Turn	Left	Thru	Right	U-Turn	Left	Thru	Right	U-Turn	Left	Thru	Right			West	East	South	North
	7:00 AM	0	0	0	1	0	0	0	0	0	1	123	0	0	0	185			0	310	1,912	0
7:15 AM	0	0	0	3	0	0	0	0	0	0	173	0	0	0	317	0	493	2,126	0	1	0	0
7:30 AM	0	0	0	0	0	0	0	0	0	1	197	0	0	0	340	0	538	2,118	0	1	0	0
7:45 AM	0	0	0	0	0	0	0	0	0	0	201	0	0	0	370	0	571	2,140	1	2	0	0
8:00 AM	0	0	0	0	0	0	0	0	1	1	201	0	0	0	321	0	524	2,149	0	0	0	0
8:15 AM	0	0	0	0	0	0	0	0	0	1	169	0	0	0	314	1	485		0	3	0	0
8:30 AM	0	0	0	2	0	0	0	0	0	3	190	0	0	0	363	2	560		0	2	0	0
8:45 AM	0	0	0	1	0	0	0	0	0	2	188	0	0	0	388	1	580		0	0	0	0
Count Total	0	0	0	7	0	0	0	0	1	9	1,442	0	0	0	2,598	4	4,061		1	10	0	0
Peak Hour	0	0	0	3	0	0	0	0	1	7	748	0	0	0	1,386	4	2,149		0	5	0	0

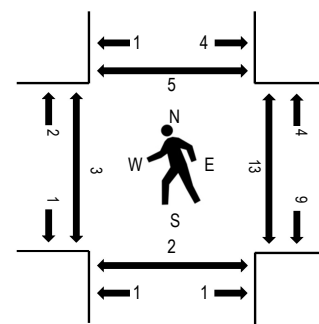
Peak Hour - Motorized Vehicles



Peak Hour - Bicycles



Peak Hour - Pedestrians

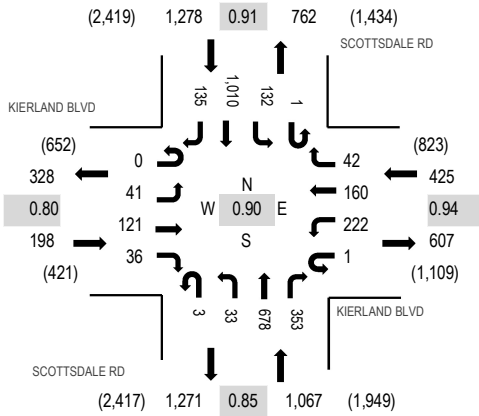


Note: Total study counts contained in parentheses.

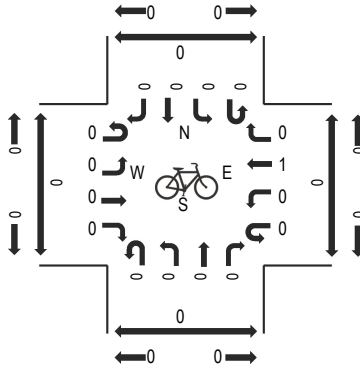
Traffic Counts - Motorized Vehicles

Interval Start Time	TIERRA BUENA LN Eastbound				TIERRA BUENA LN Westbound				SCOTTSDALE RD Northbound				SCOTTSDALE RD Southbound				Total	Rolling Hour	Pedestrian Crossings			
	U-Turn	Left	Thru	Right	U-Turn	Left	Thru	Right	U-Turn	Left	Thru	Right	U-Turn	Left	Thru	Right			West	East	South	North
7:00 AM	0	3	1	3	0	5	0	19	1	4	97	16	0	9	172	3	333	2,027	0	1	0	0
7:15 AM	0	3	4	6	0	3	0	37	1	3	128	28	1	12	303	4	533	2,242	1	0	0	1
7:30 AM	0	3	0	1	0	5	0	42	1	1	152	19	0	17	317	4	562	2,194	0	1	0	0
7:45 AM	0	2	1	7	0	4	1	30	2	2	172	13	0	23	339	3	599	2,215	2	4	0	1
8:00 AM	0	4	0	3	0	3	0	18	1	2	181	15	0	24	292	5	548	2,205	0	8	2	3
8:15 AM	0	0	1	2	0	4	0	11	0	0	162	4	0	12	285	4	485		0	1	0	0
8:30 AM	0	4	1	2	0	1	0	8	3	2	179	7	0	12	360	4	583		2	3	0	0
8:45 AM	0	3	0	8	0	4	1	8	2	3	175	10	0	23	343	9	589		0	1	0	0
Count Total	0	22	8	32	0	29	2	173	11	17	1,246	112	1	132	2,411	36	4,232		5	19	2	5
Peak Hour	0	12	5	17	0	15	1	127	5	8	633	75	1	76	1,251	16	2,242		3	13	2	5

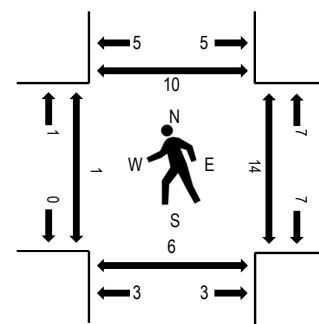
Peak Hour - Motorized Vehicles



Peak Hour - Bicycles



Peak Hour - Pedestrians

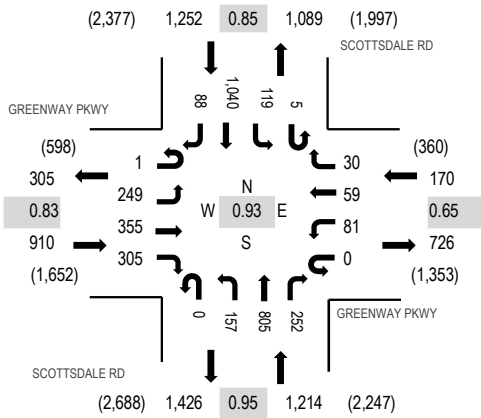


Note: Total study counts contained in parentheses.

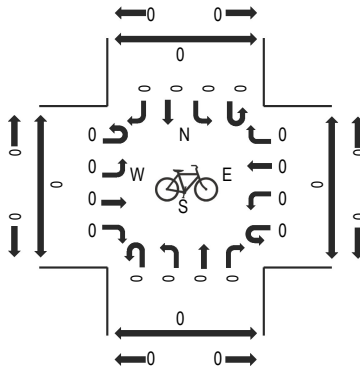
Traffic Counts - Motorized Vehicles

Interval Start Time	KIERLAND BLVD Eastbound				KIERLAND BLVD Westbound				SCOTTSDALE RD Northbound				SCOTTSDALE RD Southbound				Total	Rolling Hour	Pedestrian Crossings			
	U-Turn	Left	Thru	Right	U-Turn	Left	Thru	Right	U-Turn	Left	Thru	Right	U-Turn	Left	Thru	Right			West	East	South	North
7:00 AM	1	11	17	10	0	28	22	8	1	6	90	62	0	9	144	20	429	2,687	0	2	3	1
7:15 AM	1	15	20	14	0	51	46	10	0	11	145	63	1	31	256	26	690	2,924	4	0	1	2
7:30 AM	0	16	40	12	0	51	54	15	3	11	155	75	0	33	256	26	747	2,956	0	5	1	0
7:45 AM	0	6	36	7	1	64	39	5	0	8	181	124	0	36	279	35	821	2,968	0	4	3	2
8:00 AM	0	15	21	8	0	56	39	19	0	8	147	67	0	28	215	43	666	2,925	0	4	0	5
8:15 AM	0	10	36	11	0	46	41	8	1	8	168	96	1	35	243	18	722		1	2	1	0
8:30 AM	0	10	28	10	0	56	41	10	2	9	182	66	0	33	273	39	759		0	4	2	3
8:45 AM	0	22	33	11	0	53	48	12	1	13	172	74	0	45	255	39	778		1	4	3	2
Count Total	2	105	231	83	1	405	330	87	8	74	1,240	627	2	250	1,921	246	5,612		6	25	14	15
Peak Hour	0	41	121	36	1	222	160	42	3	33	678	353	1	132	1,010	135	2,968		1	14	6	10

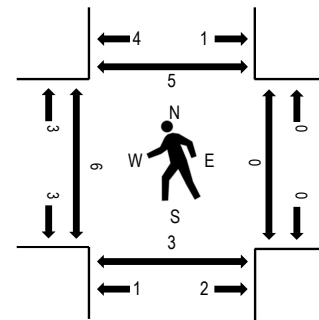
Peak Hour - Motorized Vehicles



Peak Hour - Bicycles



Peak Hour - Pedestrians

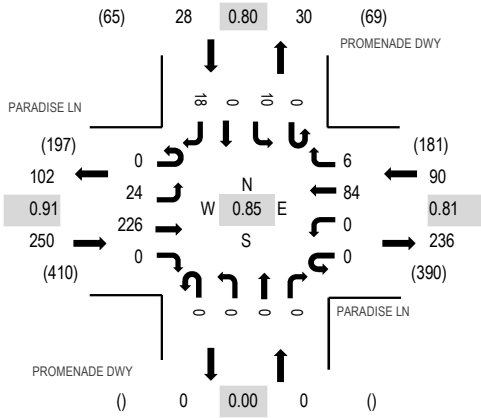


Note: Total study counts contained in parentheses.

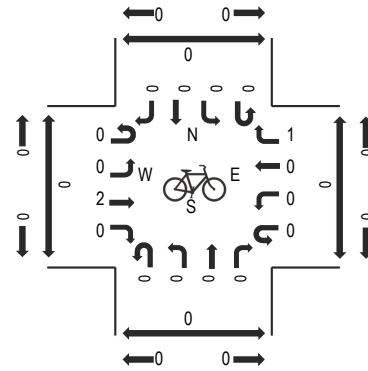
Traffic Counts - Motorized Vehicles

Interval Start Time	GREENWAY PKWY Eastbound				GREENWAY PKWY Westbound				SCOTTSDALE RD Northbound			SCOTTSDALE RD Southbound				Total	Rolling Hour	Pedestrian Crossings				
	U-Turn	Left	Thru	Right	U-Turn	Left	Thru	Right	U-Turn	Left	Thru	Right	U-Turn	Left	Thru			Right	West	East	South	North
7:00 AM	0	44	57	40	0	12	15	5	0	30	135	59	1	21	158	10	587	3,166	0	0	0	0
7:15 AM	0	54	58	55	0	19	9	5	0	40	149	44	1	30	223	23	710	3,432	0	1	0	0
7:30 AM	0	66	89	80	0	19	11	10	0	47	179	67	0	29	304	18	919	3,533	3	0	1	2
7:45 AM	1	81	119	82	0	11	17	7	0	40	205	74	2	24	260	27	950	3,546	1	0	1	1
8:00 AM	0	51	84	81	0	20	14	5	0	36	192	63	0	32	257	18	853	3,470	1	0	0	3
8:15 AM	0	61	82	67	0	22	18	11	0	40	198	48	2	31	211	20	811		4	0	1	0
8:30 AM	0	56	70	75	0	28	10	7	0	41	210	67	1	32	312	23	932		0	0	1	1
8:45 AM	0	56	85	58	0	35	30	20	0	48	181	54	2	34	259	12	874		0	0	0	1
Count Total	1	469	644	538	0	166	124	70	0	322	1,449	476	9	233	1,984	151	6,636		9	1	4	8
Peak Hour	1	249	355	305	0	81	59	30	0	157	805	252	5	119	1,040	88	3,546		6	0	3	5

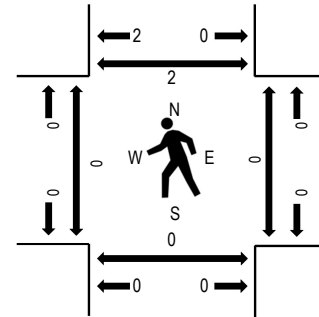
Peak Hour - Motorized Vehicles



Peak Hour - Bicycles



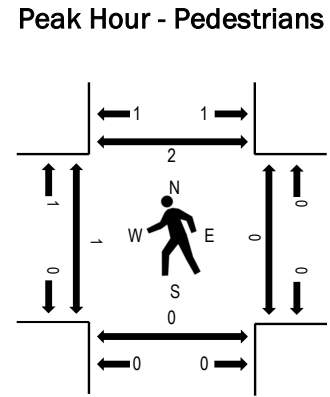
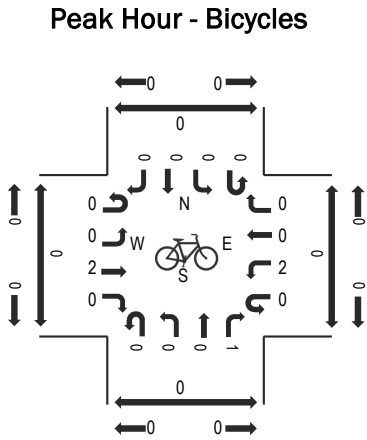
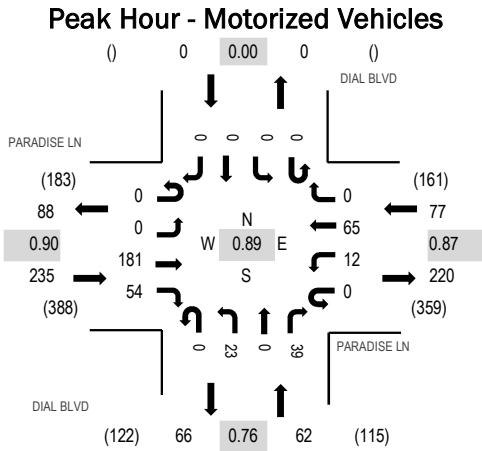
Peak Hour - Pedestrians



Note: Total study counts contained in parentheses.

Traffic Counts - Motorized Vehicles

Interval Start Time	PARADISE LN Eastbound				PARADISE LN Westbound				PROMENADE DWY Northbound				PROMENADE DWY Southbound				Total	Rolling Hour	Pedestrian Crossings			
	U-Turn	Left	Thru	Right	U-Turn	Left	Thru	Right	U-Turn	Left	Thru	Right	U-Turn	Left	Thru	Right			West	East	South	North
7:00 AM	0	1	35	0	0	0	8	2	0	0	0	0	0	3	0	0	49	326	0	0	3	0
7:15 AM	0	5	58	0	0	0	16	0	0	0	0	0	0	3	0	2	84	368	0	0	0	1
7:30 AM	0	4	63	0	0	0	15	1	0	0	0	0	0	0	0	2	85	344	0	0	0	0
7:45 AM	0	6	63	0	0	0	28	1	0	0	0	0	0	2	0	8	108	349	0	0	0	1
8:00 AM	0	9	42	0	0	0	25	4	0	0	0	0	0	5	0	6	91	330	0	0	0	0
8:15 AM	0	4	32	0	0	0	15	3	0	0	0	0	0	2	0	4	60		0	0	1	1
8:30 AM	0	7	35	0	0	0	27	7	0	0	0	0	0	4	0	10	90		0	0	0	0
8:45 AM	0	8	38	0	0	0	22	7	0	0	0	0	0	5	0	9	89		0	1	0	1
Count Total	0	44	366	0	0	0	156	25	0	0	0	0	0	24	0	41	656		0	1	4	4
Peak Hour	0	24	226	0	0	0	84	6	0	0	0	0	0	10	0	18	368		0	0	0	2



Note: Total study counts contained in parentheses.

Traffic Counts - Motorized Vehicles

Interval Start Time	PARADISE LN Eastbound				PARADISE LN Westbound				DIAL BLVD Northbound				DIAL BLVD Southbound				Total	Rolling Hour	Pedestrian Crossings			
	U-Turn	Left	Thru	Right	U-Turn	Left	Thru	Right	U-Turn	Left	Thru	Right	U-Turn	Left	Thru	Right			West	East	South	North
7:00 AM	0	0	34	5	0	2	10	0	0	2	0	8	0	0	0	0	61	349	0	0	1	0
7:15 AM	0	0	50	15	0	3	13	0	0	4	0	9	0	0	0	0	94	374	1	0	0	2
7:30 AM	0	0	43	16	0	3	11	0	0	2	0	14	0	0	0	0	89	341	0	0	0	0
7:45 AM	0	0	50	13	0	1	21	0	0	10	0	10	0	0	0	0	105	340	0	0	0	0
8:00 AM	0	0	38	10	0	5	20	0	0	7	0	6	0	0	0	0	86	315	0	0	0	0
8:15 AM	0	0	24	9	0	4	14	0	0	5	0	5	0	0	0	0	61		0	0	0	1
8:30 AM	0	0	26	13	0	4	24	0	0	12	0	9	0	0	0	0	88		0	0	0	0
8:45 AM	0	0	28	14	0	5	21	0	0	7	0	5	0	0	0	0	80		0	0	0	1
Count Total	0	0	293	95	0	27	134	0	0	49	0	66	0	0	0	0	664		1	0	1	4
Peak Hour	0	0	181	54	0	12	65	0	0	23	0	39	0	0	0	0	374		1	0	0	2



ALL TRAFFIC DATA SERVICES

(303) 216-2439

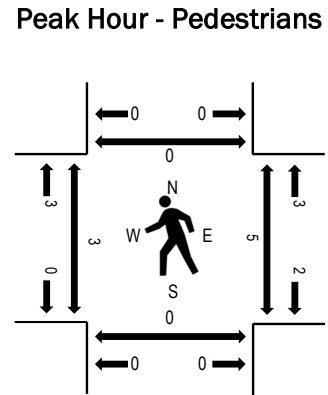
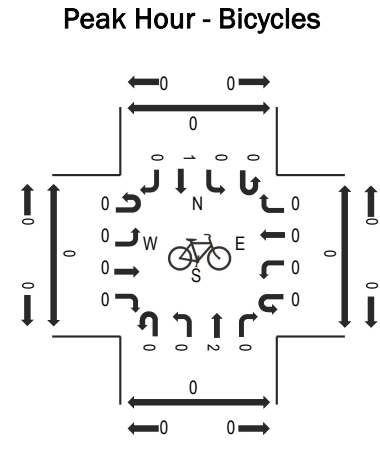
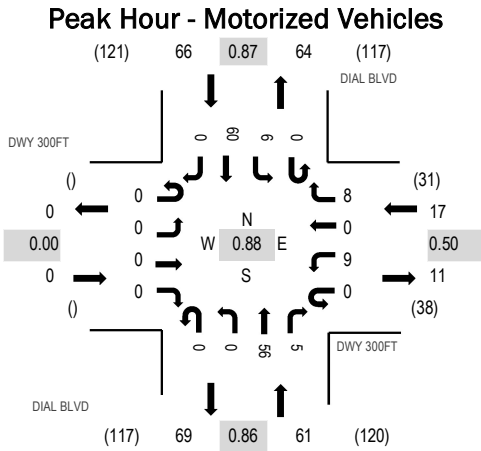
www.alltrafficdata.net

Location: 9 DIAL BLVD & DWY 300FT AM

Date: Tuesday, May 10, 2022

Peak Hour: 07:15 AM - 08:15 AM

Peak 15-Minutes: 07:30 AM - 07:45 AM

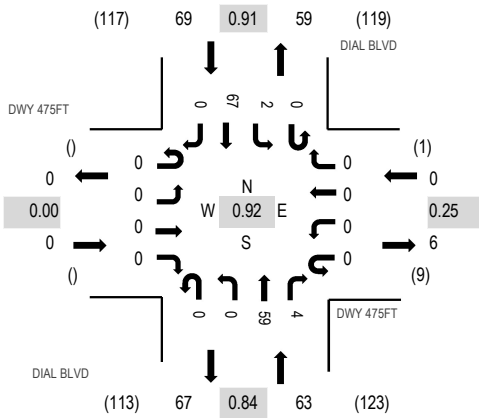


Note: Total study counts contained in parentheses.

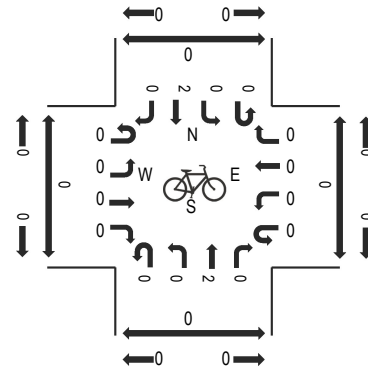
Traffic Counts - Motorized Vehicles

Interval Start Time	DWY 300FT Eastbound				DWY 300FT Westbound				DIAL BLVD Northbound				DIAL BLVD Southbound				Total	Rolling Hour	Pedestrian Crossings			
	U-Turn	Left	Thru	Right	U-Turn	Left	Thru	Right	U-Turn	Left	Thru	Right	U-Turn	Left	Thru	Right			West	East	South	North
7:00 AM	0	0	0	0	0	0	0	0	0	0	9	5	0	1	6	0	21	135	0	0	0	0
7:15 AM	0	0	0	0	0	0	0	0	0	0	13	2	0	0	17	0	32	144	1	2	0	0
7:30 AM	0	0	0	0	0	3	0	1	0	0	16	2	0	5	14	0	41	138	0	1	0	0
7:45 AM	0	0	0	0	0	5	0	6	0	0	15	0	0	1	14	0	41	139	2	1	0	0
8:00 AM	0	0	0	0	0	1	0	1	0	0	12	1	0	0	15	0	30	137	0	1	0	0
8:15 AM	0	0	0	0	0	2	0	3	0	0	7	1	0	3	10	0	26		1	0	0	0
8:30 AM	0	0	0	0	0	1	0	2	0	0	19	3	0	4	13	0	42		1	1	0	0
8:45 AM	0	0	0	0	0	3	0	3	0	0	10	5	0	5	13	0	39		1	1	0	0
Count Total	0	0	0	0	0	15	0	16	0	0	101	19	0	19	102	0	272		6	7	0	0
Peak Hour	0	0	0	0	0	9	0	8	0	0	56	5	0	6	60	0	144		3	5	0	0

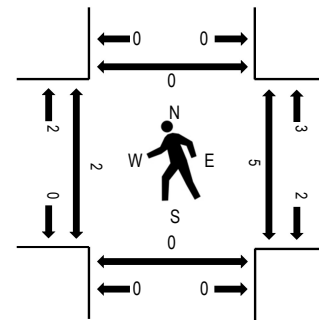
Peak Hour - Motorized Vehicles



Peak Hour - Bicycles



Peak Hour - Pedestrians

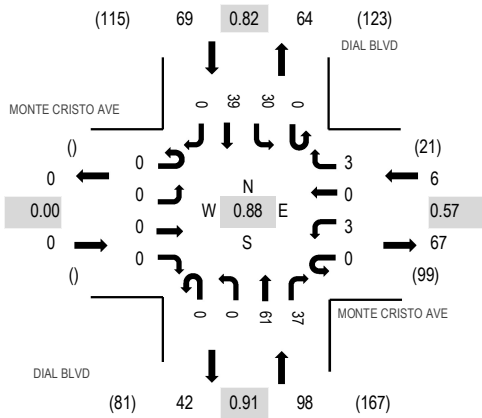


Note: Total study counts contained in parentheses.

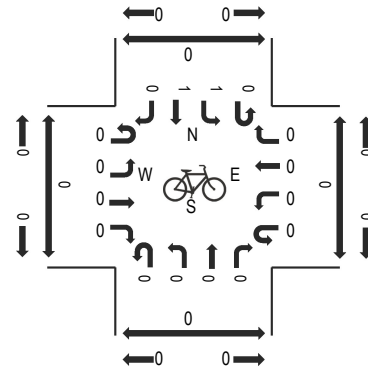
Traffic Counts - Motorized Vehicles

Interval Start Time	DWY 475FT Eastbound				DWY 475FT Westbound				DIAL BLVD Northbound				DIAL BLVD Southbound				Total	Rolling Hour	Pedestrian Crossings				
	U-Turn	Left	Thru	Right	U-Turn	Left	Thru	Right	U-Turn	Left	Thru	Right	U-Turn	Left	Thru	Right			West	East	South	North	
7:00 AM	0	0	0	0	0	0	0	0	0	0	15	0	0	0	1	5	0	21	123	0	0	0	0
7:15 AM	0	0	0	0	0	0	0	0	0	0	15	1	0	0	0	17	0	33	132	1	2	0	0
7:30 AM	0	0	0	0	0	0	0	0	0	0	19	0	0	0	1	16	0	36	120	0	1	0	0
7:45 AM	0	0	0	0	0	0	0	0	0	0	13	1	0	0	0	19	0	33	120	1	1	0	0
8:00 AM	0	0	0	0	0	0	0	0	0	0	12	2	0	1	15	0	0	30	118	0	1	0	0
8:15 AM	0	0	0	0	0	1	0	0	0	0	8	0	0	1	11	0	0	21		1	0	0	0
8:30 AM	0	0	0	0	0	0	0	0	0	0	22	0	0	0	14	0	0	36		1	0	0	0
8:45 AM	0	0	0	0	0	0	0	0	0	0	15	0	0	1	15	0	0	31		1	1	1	0
Count Total	0	0	0	0	0	1	0	0	0	0	119	4	0	5	112	0	0	241		5	6	1	0
Peak Hour	0	0	0	0	0	0	0	0	0	0	59	4	0	2	67	0	0	132		2	5	0	0

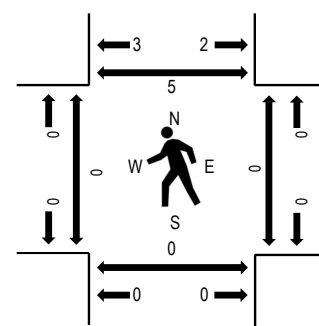
Peak Hour - Motorized Vehicles



Peak Hour - Bicycles



Peak Hour - Pedestrians



Note: Total study counts contained in parentheses.

Traffic Counts - Motorized Vehicles

Interval Start Time	MONTE CRISTO AVE Eastbound				MONTE CRISTO AVE Westbound				DIAL BLVD Northbound				DIAL BLVD Southbound				Total	Rolling Hour	Pedestrian Crossings			
	U-Turn	Left	Thru	Right	U-Turn	Left	Thru	Right	U-Turn	Left	Thru	Right	U-Turn	Left	Thru	Right			West	East	South	North
7:00 AM	0	0	0	0	0	0	0	2	0	0	12	2	0	0	5	0	21	160	0	0	0	0
7:15 AM	0	0	0	0	0	0	0	1	0	0	14	13	0	10	8	0	46	173	0	0	0	1
7:30 AM	0	0	0	0	0	1	0	0	0	0	19	8	0	7	9	0	44	156	0	0	0	1
7:45 AM	0	0	0	0	0	0	0	1	0	0	16	11	0	8	13	0	49	155	0	0	0	1
8:00 AM	0	0	0	0	0	2	0	1	0	0	12	5	0	5	9	0	34	143	0	0	0	2
8:15 AM	0	0	0	0	0	2	0	1	0	0	6	8	0	4	8	0	29		2	0	0	0
8:30 AM	0	0	0	0	0	2	0	5	0	0	19	3	0	5	9	0	43		0	0	0	0
8:45 AM	0	0	0	0	0	2	0	1	0	0	13	6	0	4	11	0	37		0	0	0	1
Count Total	0	0	0	0	0	9	0	12	0	0	111	56	0	43	72	0	303		2	0	0	6
Peak Hour	0	0	0	0	0	3	0	3	0	0	61	37	0	30	39	0	173		0	0	0	5



ALL TRAFFIC DATA SERVICES

(303) 216-2439

www.alltrafficdata.net

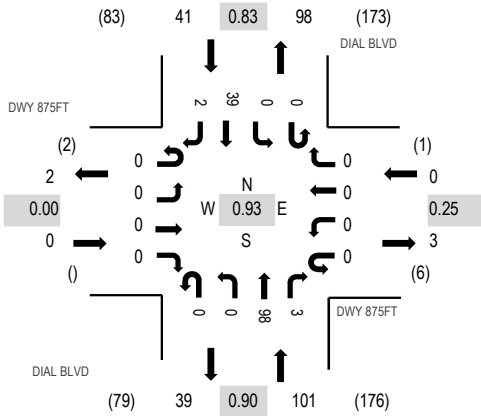
Location: 12 DIAL BLVD & DWY 875FT AM

Date: Tuesday, May 10, 2022

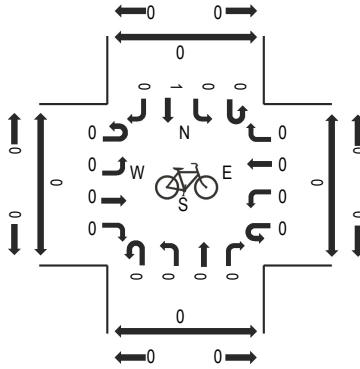
Peak Hour: 07:15 AM - 08:15 AM

Peak 15-Minutes: 07:30 AM - 07:45 AM

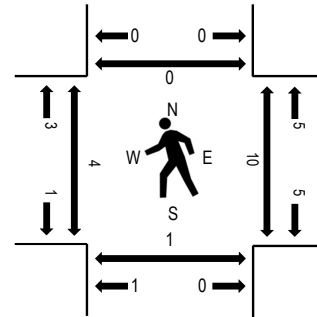
Peak Hour - Motorized Vehicles



Peak Hour - Bicycles



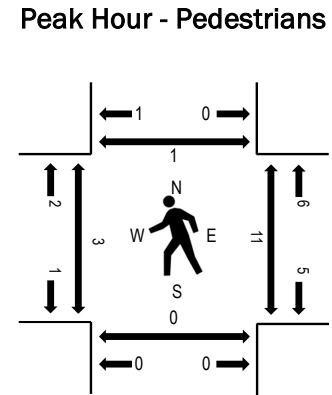
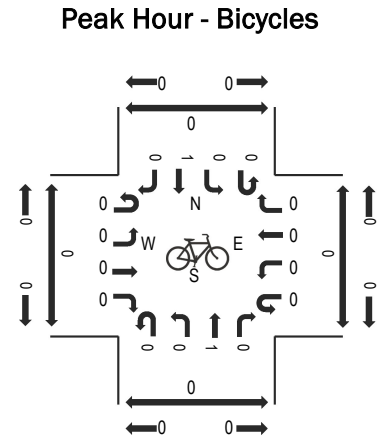
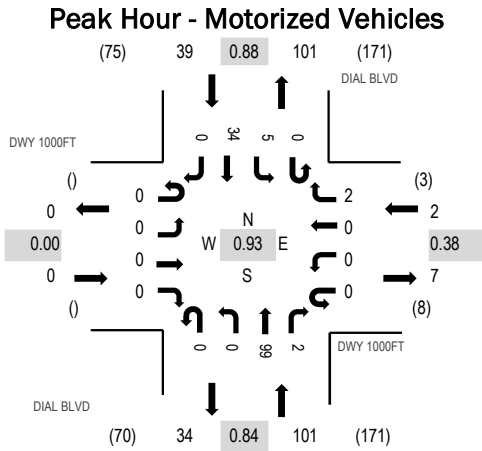
Peak Hour - Pedestrians



Note: Total study counts contained in parentheses.

Traffic Counts - Motorized Vehicles

Interval Start Time	DWY 875FT Eastbound				DWY 875FT Westbound				DIAL BLVD Northbound				DIAL BLVD Southbound				Total	Rolling Hour	Pedestrian Crossings			
	U-Turn	Left	Thru	Right	U-Turn	Left	Thru	Right	U-Turn	Left	Thru	Right	U-Turn	Left	Thru	Right			West	East	South	North
7:00 AM	0	0	0	0	0	0	0	0	0	0	15	0	0	0	5	0	20	129	0	0	0	0
7:15 AM	0	0	0	0	0	0	0	0	0	0	27	1	0	0	7	0	35	142	1	2	0	0
7:30 AM	0	0	0	0	0	0	0	0	0	0	27	0	0	0	11	0	38	130	0	2	1	0
7:45 AM	0	0	0	0	0	0	0	0	0	0	25	1	0	0	10	0	36	133	1	5	0	0
8:00 AM	0	0	0	0	0	0	0	0	0	0	19	1	0	0	11	2	33	131	2	1	0	0
8:15 AM	0	0	0	0	0	0	0	0	0	0	14	0	0	0	9	0	23		1	3	0	0
8:30 AM	0	0	0	0	0	0	0	0	0	0	26	0	0	1	14	0	41		1	0	0	0
8:45 AM	0	0	0	0	0	1	0	0	0	0	20	0	0	2	11	0	34		2	1	0	0
Count Total	0	0	0	0	0	1	0	0	0	0	173	3	0	3	78	2	260		8	14	1	0
Peak Hour	0	0	0	0	0	0	0	0	0	0	98	3	0	0	39	2	142		4	10	1	0

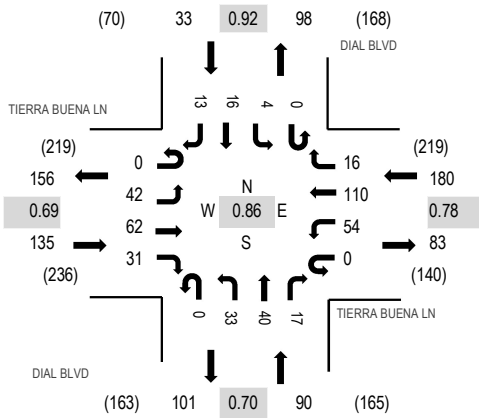


Note: Total study counts contained in parentheses.

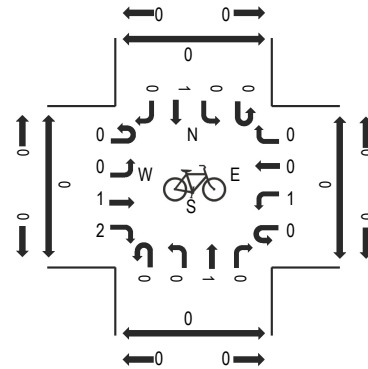
Traffic Counts - Motorized Vehicles

Interval Start Time	DWY 1000FT Eastbound				DWY 1000FT Westbound				DIAL BLVD Northbound				DIAL BLVD Southbound				Total	Rolling Hour	Pedestrian Crossings				
	U-Turn	Left	Thru	Right	U-Turn	Left	Thru	Right	U-Turn	Left	Thru	Right	U-Turn	Left	Thru	Right			West	East	South	North	
7:00 AM	0	0	0	0	0	0	0	0	1	0	0	14	1	0	0	4	0	20	132	0	0	0	0
7:15 AM	0	0	0	0	0	0	0	0	0	0	0	30	0	0	2	6	0	38	142	1	2	0	0
7:30 AM	0	0	0	0	0	0	0	0	0	0	0	25	0	0	2	9	0	36	128	2	3	0	1
7:45 AM	0	0	0	0	0	0	0	0	2	0	0	26	0	0	1	9	0	38	124	0	5	0	0
8:00 AM	0	0	0	0	0	0	0	0	0	0	0	18	2	0	0	10	0	30	117	0	1	0	0
8:15 AM	0	0	0	0	0	0	0	0	0	0	0	14	0	0	0	10	0	24		1	0	0	0
8:30 AM	0	0	0	0	0	0	0	0	0	0	0	22	0	0	0	10	0	32		1	0	0	0
8:45 AM	0	0	0	0	0	0	0	0	0	0	0	19	0	0	0	12	0	31		1	1	0	0
Count Total	0	0	0	0	0	0	0	0	3	0	0	168	3	0	5	70	0	249		6	12	0	1
Peak Hour	0	0	0	0	0	0	0	0	2	0	0	99	2	0	5	34	0	142		3	11	0	1

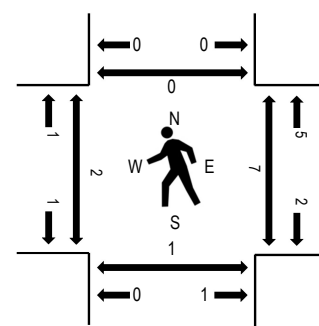
Peak Hour - Motorized Vehicles



Peak Hour - Bicycles



Peak Hour - Pedestrians



Note: Total study counts contained in parentheses.

Traffic Counts - Motorized Vehicles

Interval Start Time	TIERRA BUENA LN Eastbound				TIERRA BUENA LN Westbound				DIAL BLVD Northbound				DIAL BLVD Southbound				Total	Rolling Hour	Pedestrian Crossings			
	U-Turn	Left	Thru	Right	U-Turn	Left	Thru	Right	U-Turn	Left	Thru	Right	U-Turn	Left	Thru	Right			West	East	South	North
7:00 AM	0	6	12	8	0	5	17	3	0	5	6	3	0	2	1	1	69	427	0	0	0	0
7:15 AM	0	9	13	4	0	12	35	3	0	11	10	5	0	1	2	2	107	438	1	1	1	0
7:30 AM	0	8	12	3	0	19	34	8	0	10	16	6	0	2	3	3	124	388	1	5	0	0
7:45 AM	0	15	22	12	0	16	34	4	0	5	7	3	0	1	5	3	127	323	0	1	0	0
8:00 AM	0	10	15	12	0	7	7	1	0	7	7	3	0	0	6	5	80	263	0	0	0	0
8:15 AM	0	5	10	8	0	2	2	0	0	8	9	3	0	2	4	4	57		1	1	1	0
8:30 AM	0	6	5	9	0	2	1	1	0	6	15	3	0	2	4	5	59		0	0	0	0
8:45 AM	0	9	11	12	0	1	5	0	0	4	10	3	0	1	6	5	67		0	0	0	0
Count Total	0	68	100	68	0	64	135	20	0	56	80	29	0	11	31	28	690		3	8	2	0
Peak Hour	0	42	62	31	0	54	110	16	0	33	40	17	0	4	16	13	438		2	7	1	0

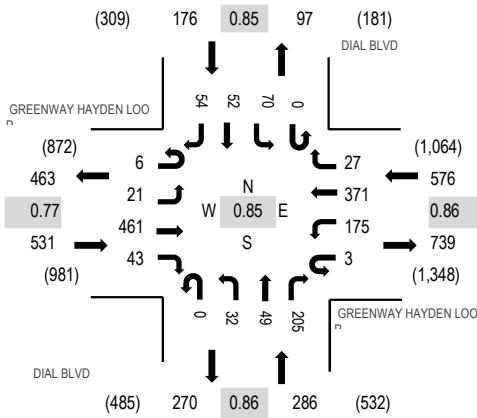
Location: 15 DIAL BLVD & GREENWAY HAYDEN LOOP AM

Date: Tuesday, May 10, 2022

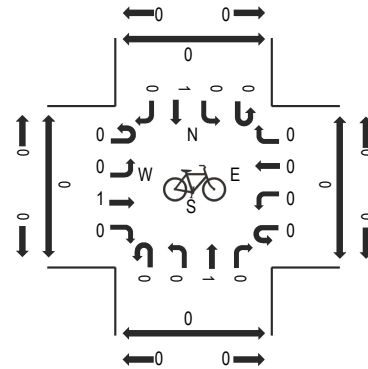
Peak Hour: 07:45 AM - 08:45 AM

Peak 15-Minutes: 07:45 AM - 08:00 AM

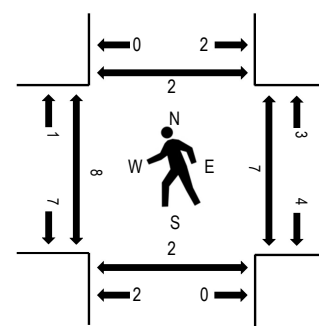
Peak Hour - Motorized Vehicles



Peak Hour - Bicycles



Peak Hour - Pedestrians

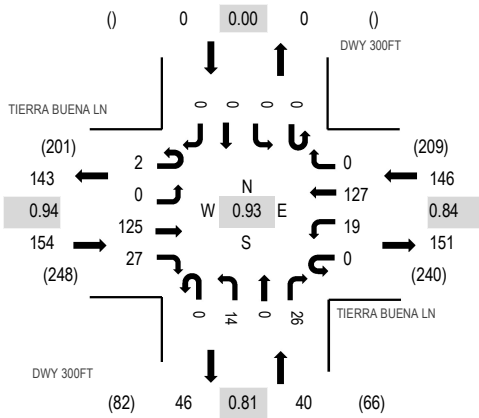


Note: Total study counts contained in parentheses.

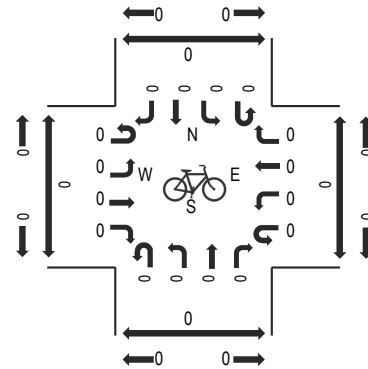
Traffic Counts - Motorized Vehicles

Interval Start Time	GREENWAY HAYDEN Eastbound				GREENWAY HAYDEN Westbound				DIAL BLVD Northbound				DIAL BLVD Southbound				Total	Rolling Hour	Pedestrian Crossings			
	U-Turn	Left	Thru	Right	U-Turn	Left	Thru	Right	U-Turn	Left	Thru	Right	U-Turn	Left	Thru	Right			West	East	South	North
7:00 AM	1	7	71	4	1	17	39	5	0	1	8	31	0	8	6	14	213	1,357	2	1	3	2
7:15 AM	1	5	91	8	1	35	89	8	0	6	9	42	0	5	6	19	325	1,514	0	1	1	0
7:30 AM	2	3	109	9	1	45	76	4	0	8	6	55	0	10	7	23	358	1,557	0	1	0	0
7:45 AM	2	4	159	12	1	55	105	7	0	3	8	53	0	15	17	20	461	1,569	0	4	2	1
8:00 AM	1	7	84	10	0	55	92	6	0	9	15	47	0	16	15	13	370	1,529	6	2	0	0
8:15 AM	0	3	132	9	1	29	87	6	0	10	10	43	0	21	10	7	368		0	1	0	0
8:30 AM	3	7	86	12	1	36	87	8	0	10	16	62	0	18	10	14	370		2	0	0	1
8:45 AM	0	9	115	15	1	47	111	8	0	7	12	61	0	7	16	12	421		3	0	3	2
Count Total	10	45	847	79	7	319	686	52	0	54	84	394	0	100	87	122	2,886		13	10	9	6
Peak Hour	6	21	461	43	3	175	371	27	0	32	49	205	0	70	52	54	1,569		8	7	2	2

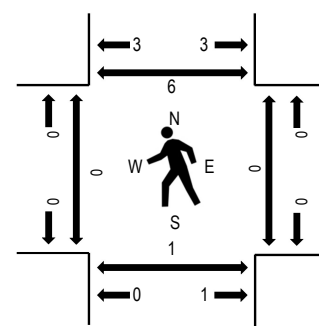
Peak Hour - Motorized Vehicles



Peak Hour - Bicycles



Peak Hour - Pedestrians

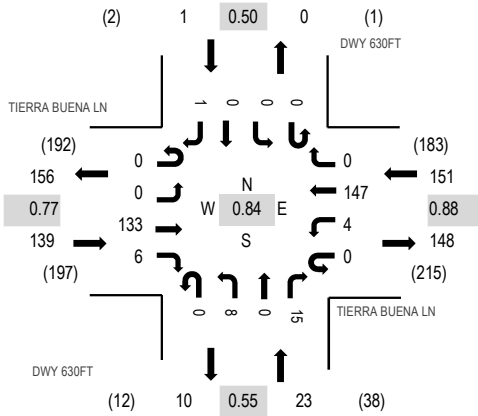


Note: Total study counts contained in parentheses.

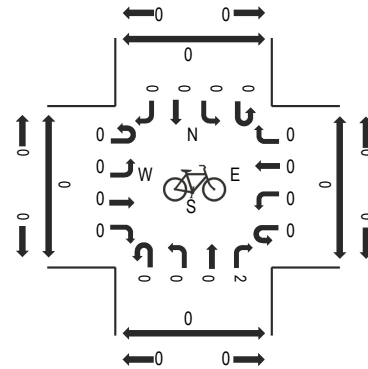
Traffic Counts - Motorized Vehicles

Interval Start Time	TIERRA BUENA LN Eastbound				TIERRA BUENA LN Westbound				DWY 300FT Northbound			DWY 300FT Southbound				Total	Rolling Hour	Pedestrian Crossings				
	U-Turn	Left	Thru	Right	U-Turn	Left	Thru	Right	U-Turn	Left	Thru	Right	U-Turn	Left	Thru			Right	West	East	South	North
7:00 AM	1	0	24	2	0	4	22	0	0	1	0	1	0	0	0	0	55	326	0	0	1	1
7:15 AM	1	0	32	8	0	5	39	0	0	2	0	4	0	0	0	0	91	340	0	0	1	4
7:30 AM	0	0	27	8	0	4	42	0	0	3	0	7	0	0	0	0	91	286	0	0	0	2
7:45 AM	0	0	33	6	0	5	34	0	0	1	0	10	0	0	0	0	89	230	0	0	0	0
8:00 AM	1	0	33	5	0	5	12	0	0	8	0	5	0	0	0	0	69	197	0	0	0	0
8:15 AM	0	0	15	2	0	4	8	0	0	5	0	3	0	0	0	0	37		0	0	0	0
8:30 AM	1	0	15	3	0	5	7	0	0	1	0	3	0	0	0	0	35		0	0	1	0
8:45 AM	0	0	22	9	0	7	6	0	0	6	0	6	0	0	0	0	56		0	0	0	0
Count Total	4	0	201	43	0	39	170	0	0	27	0	39	0	0	0	0	523		0	0	3	7
Peak Hour	2	0	125	27	0	19	127	0	0	14	0	26	0	0	0	0	340		0	0	1	6

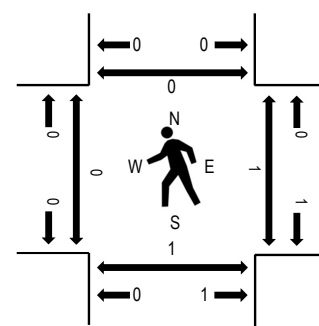
Peak Hour - Motorized Vehicles



Peak Hour - Bicycles



Peak Hour - Pedestrians

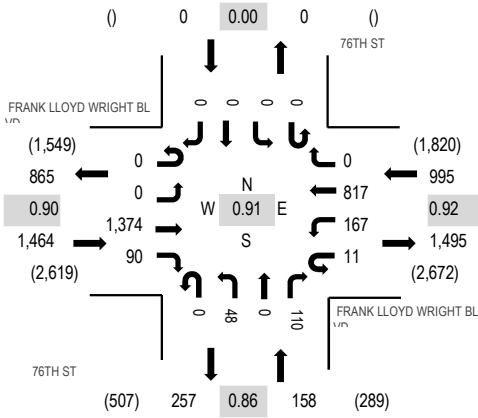


Note: Total study counts contained in parentheses.

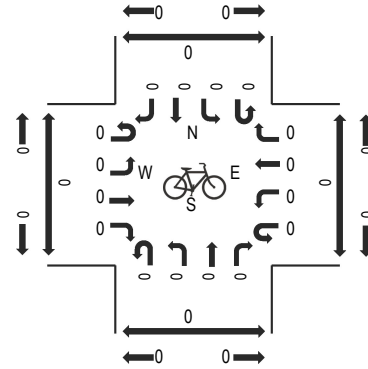
Traffic Counts - Motorized Vehicles

Interval Start Time	TIERRA BUENA LN Eastbound				TIERRA BUENA LN Westbound				DWY 630FT Northbound				DWY 630FT Southbound				Total	Rolling Hour	Pedestrian Crossings			
	U-Turn	Left	Thru	Right	U-Turn	Left	Thru	Right	U-Turn	Left	Thru	Right	U-Turn	Left	Thru	Right			West	East	South	North
7:00 AM	0	0	10	0	0	0	7	0	0	0	0	1	0	0	0	0	18	106	0	0	0	0
7:15 AM	0	0	12	1	0	1	6	0	0	1	0	0	0	0	0	0	21	144	0	0	0	0
7:30 AM	0	0	16	0	0	0	9	1	0	4	0	7	0	1	0	0	38	203	0	2	0	0
7:45 AM	0	0	19	0	0	0	8	0	0	1	0	1	0	0	0	0	29	249	0	0	2	0
8:00 AM	0	0	23	2	0	0	23	0	0	4	0	4	0	0	0	0	56	314	0	0	0	0
8:15 AM	0	0	32	2	0	0	42	0	0	2	0	1	0	0	0	1	80		0	1	1	0
8:30 AM	0	0	33	2	0	0	43	0	0	2	0	4	0	0	0	0	84		0	0	0	0
8:45 AM	0	0	45	0	0	4	39	0	0	0	0	6	0	0	0	0	94		0	0	0	0
Count Total	0	0	190	7	0	5	177	1	0	14	0	24	0	1	0	1	420		0	3	3	0
Peak Hour	0	0	133	6	0	4	147	0	0	8	0	15	0	0	0	1	314		0	1	1	0

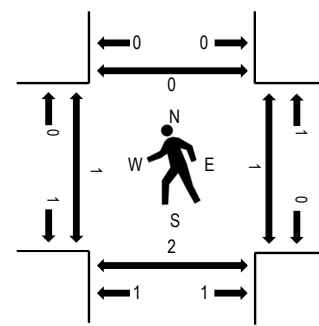
Peak Hour - Motorized Vehicles



Peak Hour - Bicycles



Peak Hour - Pedestrians

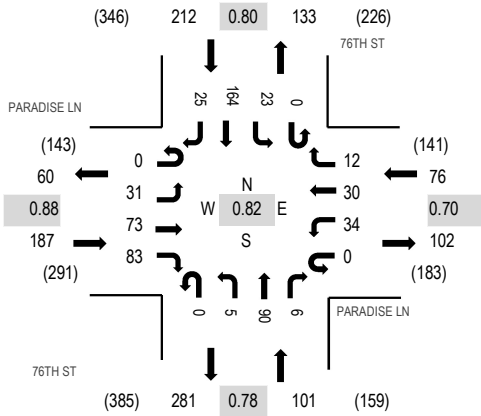


Note: Total study counts contained in parentheses.

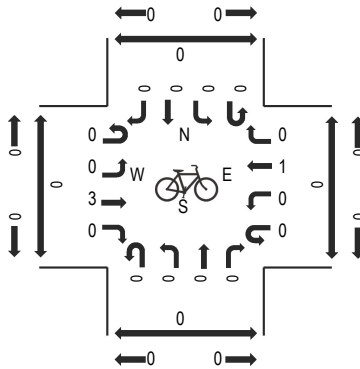
Traffic Counts - Motorized Vehicles

Interval Start Time	FRANK LLOYD WRIGHT Blvd Eastbound				FRANK LLOYD WRIGHT Blvd Westbound				76TH ST Northbound				76TH ST Southbound				Total	Rolling Hour	Pedestrian Crossings			
	U-Turn	Left	Thru	Right	U-Turn	Left	Thru	Right	U-Turn	Left	Thru	Right	U-Turn	Left	Thru	Right			West	East	South	North
7:00 AM	0	0	262	23	1	23	122	0	0	3	0	21	0	0	0	0	455	2,394	0	0	0	0
7:15 AM	0	0	234	37	1	42	156	0	0	7	0	26	0	0	0	0	503	2,591	0	0	0	0
7:30 AM	0	0	383	24	1	39	223	0	0	11	0	33	0	0	0	0	714	2,617	0	0	0	0
7:45 AM	0	0	372	33	4	46	221	0	0	10	0	36	0	0	0	0	722	2,463	0	1	0	0
8:00 AM	0	0	349	19	5	45	205	0	0	13	0	16	0	0	0	0	652	2,334	1	0	2	0
8:15 AM	0	0	270	14	1	37	168	0	0	14	0	25	0	0	0	0	529		0	0	0	0
8:30 AM	0	0	300	22	1	29	178	0	0	2	0	28	0	0	0	0	560		0	0	0	0
8:45 AM	0	0	263	14	4	60	208	0	0	8	0	36	0	0	0	0	593		0	0	2	1
Count Total	0	0	2,433	186	18	321	1,481	0	0	68	0	221	0	0	0	0	4,728		1	1	4	1
Peak Hour	0	0	1,374	90	11	167	817	0	0	48	0	110	0	0	0	0	2,617		1	1	2	0

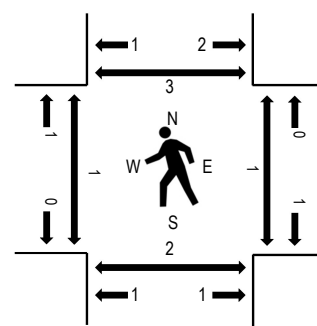
Peak Hour - Motorized Vehicles



Peak Hour - Bicycles



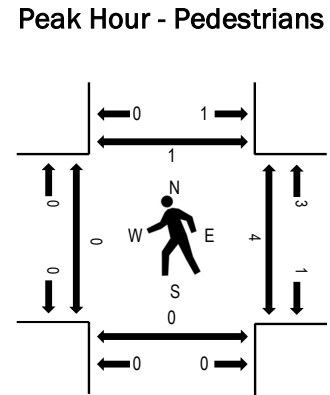
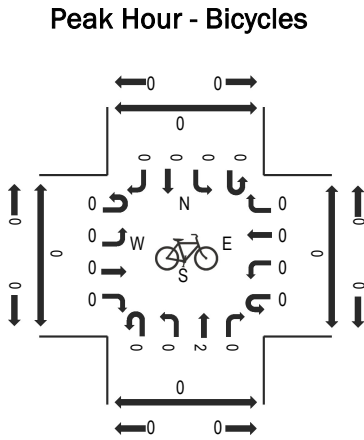
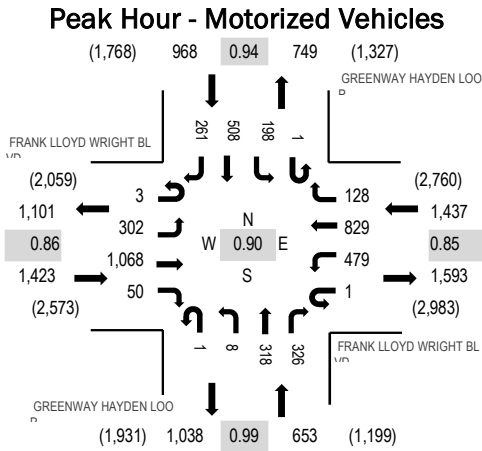
Peak Hour - Pedestrians



Note: Total study counts contained in parentheses.

Traffic Counts - Motorized Vehicles

Interval Start Time	PARADISE LN Eastbound				PARADISE LN Westbound				76TH ST Northbound				76TH ST Southbound				Total	Rolling Hour	Pedestrian Crossings			
	U-Turn	Left	Thru	Right	U-Turn	Left	Thru	Right	U-Turn	Left	Thru	Right	U-Turn	Left	Thru	Right			West	East	South	North
7:00 AM	0	8	10	7	0	3	7	0	0	1	11	3	0	2	26	3	81	564	0	2	0	0
7:15 AM	0	6	14	23	0	12	9	1	0	2	27	3	0	6	56	4	163	576	0	0	2	1
7:30 AM	0	11	13	26	0	8	5	1	0	2	24	1	0	5	41	7	144	501	0	0	0	0
7:45 AM	0	5	21	27	0	12	11	5	0	1	33	1	0	5	51	4	176	457	0	0	0	1
8:00 AM	0	9	25	7	0	2	5	5	0	0	6	1	0	7	16	10	93	373	1	1	0	1
8:15 AM	0	6	14	1	0	2	9	6	0	1	11	1	0	8	22	7	88		0	0	0	0
8:30 AM	0	11	16	5	0	1	16	4	0	1	10	5	0	6	16	9	100		0	0	0	0
8:45 AM	0	10	13	3	0	2	13	2	0	0	14	0	0	3	16	16	92		1	0	1	0
Count Total	0	66	126	99	0	42	75	24	0	8	136	15	0	42	244	60	937		2	3	3	3
Peak Hour	0	31	73	83	0	34	30	12	0	5	90	6	0	23	164	25	576		1	1	2	3

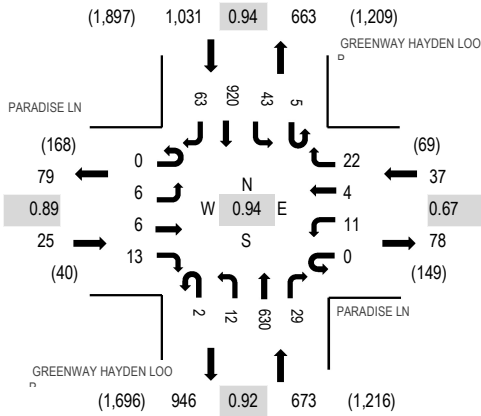


Note: Total study counts contained in parentheses.

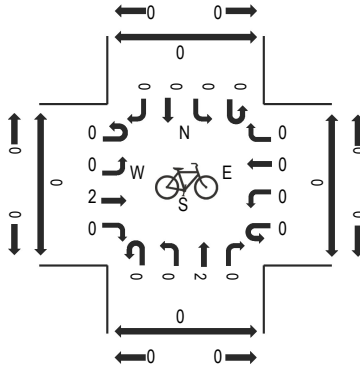
Traffic Counts - Motorized Vehicles

Interval Start Time	FRANK LLOYD WRIGHT Blvd Eastbound				FRANK LLOYD WRIGHT Blvd Westbound				GREENWAY HAYDEN LOOP Northbound				GREENWAY HAYDEN LOOP Southbound				Total	Rolling Hour	Pedestrian Crossings			
	U-Turn	Left	Thru	Right	U-Turn	Left	Thru	Right	U-Turn	Left	Thru	Right	U-Turn	Left	Thru	Right			West	East	South	North
7:00 AM	1	35	211	8	0	59	132	30	0	4	39	60	0	30	79	44	732	3,996	0	0	0	0
7:15 AM	0	59	213	1	0	111	178	27	0	4	45	79	2	33	92	67	911	4,349	1	1	1	0
7:30 AM	0	80	269	12	0	112	185	28	1	1	80	80	0	57	121	78	1,104	4,481	0	2	0	0
7:45 AM	1	95	306	14	0	137	246	26	0	2	86	78	0	45	140	73	1,249	4,403	0	0	0	0
8:00 AM	1	75	242	11	0	117	188	33	0	3	76	88	1	48	133	69	1,085	4,304	0	1	0	1
8:15 AM	1	52	251	13	1	113	210	41	0	2	76	80	0	48	114	41	1,043		0	1	0	0
8:30 AM	2	41	229	14	0	116	187	44	0	4	74	89	1	58	129	38	1,026		1	0	0	1
8:45 AM	2	70	252	12	0	148	237	54	0	9	57	82	0	54	124	49	1,150		1	0	1	1
Count Total	8	507	1,973	85	1	913	1,563	283	1	29	533	636	4	373	932	459	8,300		3	5	2	3
Peak Hour	3	302	1,068	50	1	479	829	128	1	8	318	326	1	198	508	261	4,481		0	4	0	1

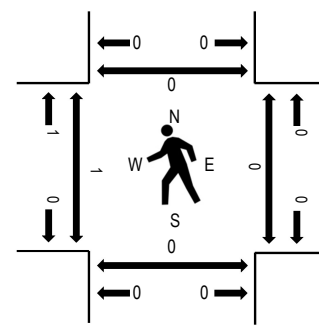
Peak Hour - Motorized Vehicles



Peak Hour - Bicycles



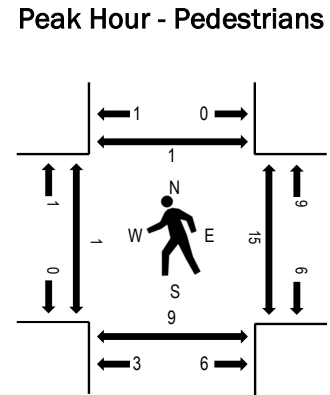
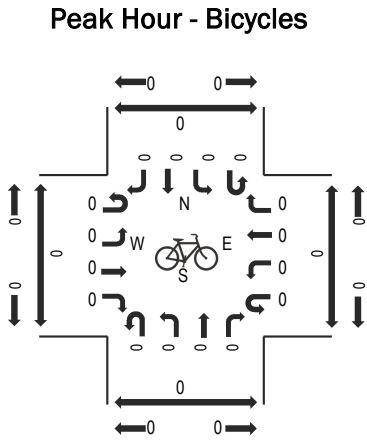
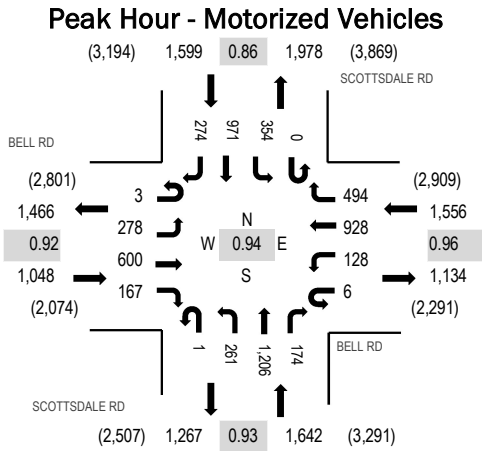
Peak Hour - Pedestrians



Note: Total study counts contained in parentheses.

Traffic Counts - Motorized Vehicles

Interval Start Time	PARADISE LN Eastbound				PARADISE LN Westbound				GREENWAY HAYDEN LOOP Northbound				GREENWAY HAYDEN LOOP Southbound				Total	Rolling Hour	Pedestrian Crossings			
	U-Turn	Left	Thru	Right	U-Turn	Left	Thru	Right	U-Turn	Left	Thru	Right	U-Turn	Left	Thru	Right			West	East	South	North
7:00 AM	0	2	0	1	0	3	0	2	0	2	99	4	1	12	119	17	262	1,467	0	2	0	0
7:15 AM	0	3	0	0	0	4	1	3	0	0	123	3	2	7	161	24	331	1,638	0	2	0	0
7:30 AM	0	1	1	0	0	2	0	2	1	2	139	6	2	14	212	20	402	1,722	0	1	0	0
7:45 AM	0	3	1	3	0	3	0	9	1	6	163	12	0	11	237	23	472	1,766	0	0	0	0
8:00 AM	0	1	1	3	0	4	1	2	0	2	149	5	3	10	240	12	433	1,755	1	0	0	0
8:15 AM	0	0	4	2	0	4	1	6	0	2	162	5	1	9	204	15	415		0	0	0	0
8:30 AM	0	2	0	5	0	0	2	5	1	2	156	7	1	13	239	13	446		0	0	0	0
8:45 AM	0	1	1	5	0	4	0	11	3	5	150	6	5	17	235	18	461		0	0	0	0
Count Total	0	13	8	19	0	24	5	40	6	21	1,141	48	15	93	1,647	142	3,222		1	5	0	0
Peak Hour	0	6	6	13	0	11	4	22	2	12	630	29	5	43	920	63	1,766		1	0	0	0



Note: Total study counts contained in parentheses.

Traffic Counts - Motorized Vehicles

Interval Start Time	BELL RD Eastbound				BELL RD Westbound				SCOTTSDALE RD Northbound				SCOTTSDALE RD Southbound				Total	Rolling Hour	Pedestrian Crossings			
	U-Turn	Left	Thru	Right	U-Turn	Left	Thru	Right	U-Turn	Left	Thru	Right	U-Turn	Left	Thru	Right			West	East	South	North
4:00 PM	0	79	163	44	1	31	233	104	1	73	314	53	0	79	202	80	1,457	5,810	1	1	3	2
4:15 PM	1	62	149	43	2	42	217	115	0	45	331	57	0	111	279	76	1,530	5,820	0	1	1	0
4:30 PM	2	73	156	32	0	34	237	110	0	77	282	36	0	72	211	56	1,378	5,845	0	4	2	0
4:45 PM	0	70	122	52	2	34	221	119	0	63	266	58	0	97	261	80	1,445	5,813	1	1	0	1
5:00 PM	0	65	173	37	2	34	234	122	1	68	343	38	0	80	217	53	1,467	5,658	0	5	5	0
5:15 PM	1	70	149	46	2	26	236	143	0	53	315	42	0	105	282	85	1,555		0	5	2	0
5:30 PM	0	65	134	47	3	26	192	100	0	58	314	47	0	75	213	72	1,346		0	3	0	0
5:45 PM	0	63	133	43	1	31	174	81	1	41	263	51	0	98	237	73	1,290		0	2	1	0
Count Total	4	547	1,179	344	13	258	1,744	894	3	478	2,428	382	0	717	1,902	575	11,468		2	22	14	3
Peak Hour	3	278	600	167	6	128	928	494	1	261	1,206	174	0	354	971	274	5,845		1	15	9	1

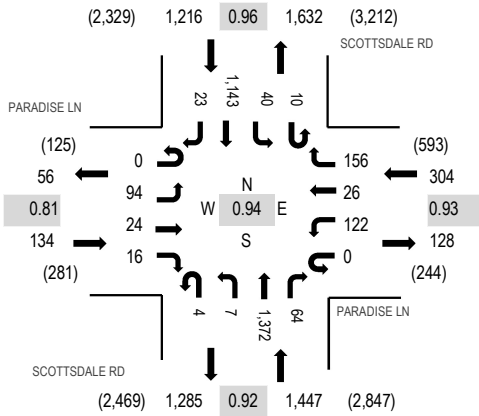
Location: 2 SCOTTSDALE RD & PARADISE LN PM

Date: Tuesday, May 10, 2022

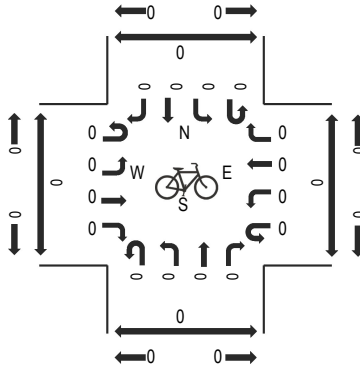
Peak Hour: 04:30 PM - 05:30 PM

Peak 15-Minutes: 05:00 PM - 05:15 PM

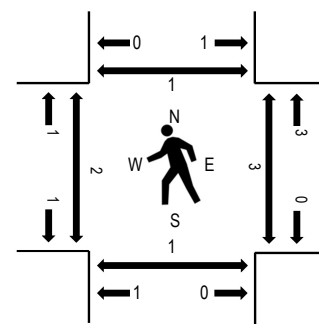
Peak Hour - Motorized Vehicles



Peak Hour - Bicycles



Peak Hour - Pedestrians

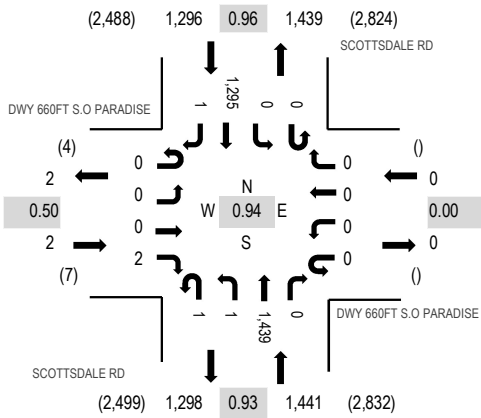


Note: Total study counts contained in parentheses.

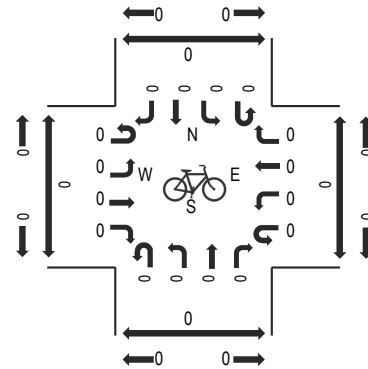
Traffic Counts - Motorized Vehicles

Interval Start Time	PARADISE LN Eastbound				PARADISE LN Westbound				SCOTTSDALE RD Northbound				SCOTTSDALE RD Southbound				Total	Rolling Hour	Pedestrian Crossings			
	U-Turn	Left	Thru	Right	U-Turn	Left	Thru	Right	U-Turn	Left	Thru	Right	U-Turn	Left	Thru	Right			West	East	South	North
4:00 PM	0	33	9	9	0	28	5	51	0	3	366	16	3	16	268	13	820	3,072	0	0	0	0
4:15 PM	0	29	12	7	0	40	10	28	0	2	344	10	1	5	281	6	775	3,080	1	0	0	1
4:30 PM	0	22	6	6	0	29	7	35	1	3	320	21	3	10	285	2	750	3,101	0	1	0	1
4:45 PM	0	25	3	4	0	32	6	40	1	1	311	17	1	11	267	8	727	3,053	0	0	0	0
5:00 PM	0	28	8	4	0	35	7	41	1	2	374	16	2	9	295	6	828	2,978	1	1	1	0
5:15 PM	0	19	7	2	0	26	6	40	1	1	367	10	4	10	296	7	796		1	1	0	0
5:30 PM	0	15	3	8	0	24	9	36	0	1	331	14	1	9	246	5	702		1	2	0	0
5:45 PM	0	16	3	3	0	29	8	21	0	1	304	8	1	11	241	6	652		2	0	0	2
Count Total	0	187	51	43	0	243	58	292	4	14	2,717	112	16	81	2,179	53	6,050		6	5	1	4
Peak Hour	0	94	24	16	0	122	26	156	4	7	1,372	64	10	40	1,143	23	3,101		2	3	1	1

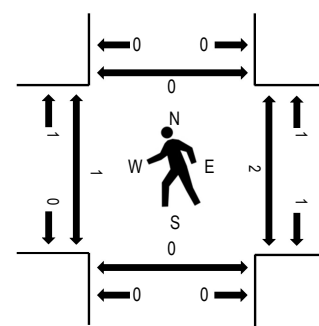
Peak Hour - Motorized Vehicles



Peak Hour - Bicycles



Peak Hour - Pedestrians

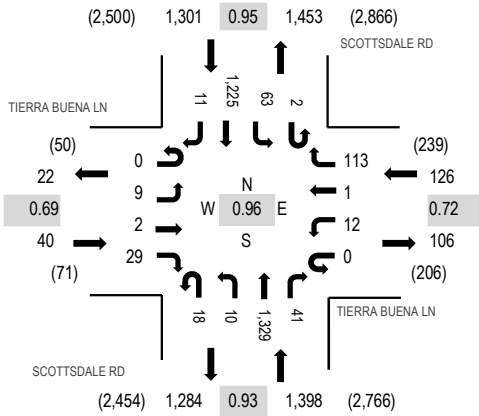


Note: Total study counts contained in parentheses.

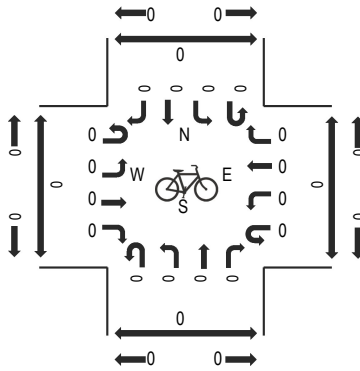
Traffic Counts - Motorized Vehicles

Interval Start Time	DWY 660FT S.O PARADISE Eastbound				DWY 660FT S.O PARADISE Westbound				SCOTTSDALE RD Northbound				SCOTTSDALE RD Southbound				Total	Rolling Hour	Pedestrian Crossings				
	U-Turn	Left	Thru	Right	U-Turn	Left	Thru	Right	U-Turn	Left	Thru	Right	U-Turn	Left	Thru	Right			West	East	South	North	
	4:00 PM	0	0	0	2	0	0	0	0	1	1	369	0	0	0	0			311	0	684	2,675	1
4:15 PM	0	0	0	1	0	0	0	0	1	1	360	0	0	0	0	328	0	691	2,716	0	1	0	0
4:30 PM	0	0	0	1	0	0	0	0	0	1	333	0	0	0	0	327	0	662	2,739	0	0	0	0
4:45 PM	0	0	0	0	0	0	0	0	0	0	335	0	0	0	0	303	0	638	2,698	0	0	0	0
5:00 PM	0	0	0	0	0	0	0	0	1	0	387	0	0	0	0	336	1	725	2,652	0	2	0	0
5:15 PM	0	0	0	1	0	0	0	0	0	0	384	0	0	0	0	329	0	714		1	0	0	0
5:30 PM	0	0	0	2	0	0	0	0	1	0	336	0	0	0	0	282	0	621		1	1	0	0
5:45 PM	0	0	0	0	0	0	0	0	1	0	320	0	0	0	0	271	0	592		1	0	0	0
Count Total	0	0	0	7	0	0	0	0	5	3	2,824	0	0	0	0	2,487	1	5,327		4	4	0	0
Peak Hour	0	0	0	2	0	0	0	0	1	1	1,439	0	0	0	0	1,295	1	2,739		1	2	0	0

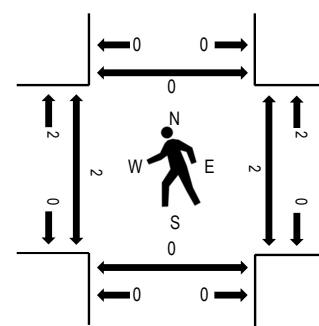
Peak Hour - Motorized Vehicles



Peak Hour - Bicycles



Peak Hour - Pedestrians



Note: Total study counts contained in parentheses.

Traffic Counts - Motorized Vehicles

Interval Start Time	TIERRA BUENA LN Eastbound				TIERRA BUENA LN Westbound				SCOTTSDALE RD Northbound				SCOTTSDALE RD Southbound				Total	Rolling Hour	Pedestrian Crossings			
	U-Turn	Left	Thru	Right	U-Turn	Left	Thru	Right	U-Turn	Left	Thru	Right	U-Turn	Left	Thru	Right			West	East	South	North
4:00 PM	0	2	0	8	0	4	2	36	5	4	325	16	1	22	293	4	722	2,826	1	0	0	0
4:15 PM	0	2	0	9	2	3	0	19	3	4	358	7	0	16	311	3	737	2,854	0	1	0	0
4:30 PM	0	4	1	13	0	3	0	28	3	4	296	11	0	19	309	3	694	2,865	0	0	0	0
4:45 PM	0	3	0	8	0	1	0	25	4	2	321	16	0	19	272	2	673	2,811	0	0	0	0
5:00 PM	0	1	0	4	0	4	1	39	6	1	347	6	2	14	321	4	750	2,750	1	1	0	0
5:15 PM	0	1	1	4	0	4	0	21	5	3	365	8	0	11	323	2	748		1	1	0	0
5:30 PM	0	0	1	3	1	3	2	22	5	1	321	3	0	11	263	4	640		0	2	0	0
5:45 PM	0	3	1	2	0	1	0	18	4	3	304	5	2	15	253	1	612		0	0	0	0
Count Total	0	16	4	51	3	23	5	208	35	22	2,637	72	5	127	2,345	23	5,576		3	5	0	0
Peak Hour	0	9	2	29	0	12	1	113	18	10	1,329	41	2	63	1,225	11	2,865		2	2	0	0

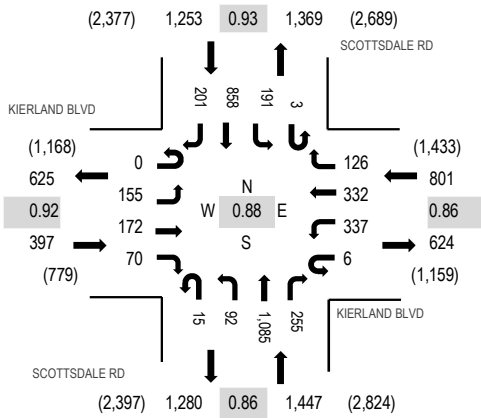
Location: 5 SCOTTSDALE RD & KIERLAND BLVD PM

Date: Tuesday, May 10, 2022

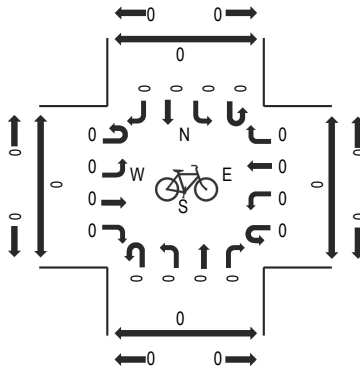
Peak Hour: 04:30 PM - 05:30 PM

Peak 15-Minutes: 05:00 PM - 05:15 PM

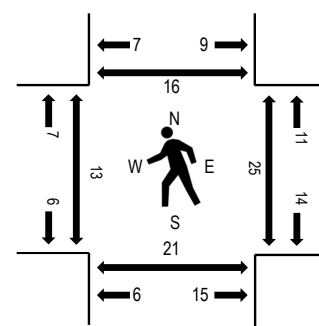
Peak Hour - Motorized Vehicles



Peak Hour - Bicycles



Peak Hour - Pedestrians

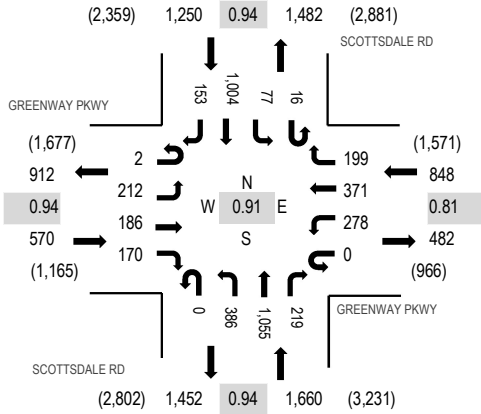


Note: Total study counts contained in parentheses.

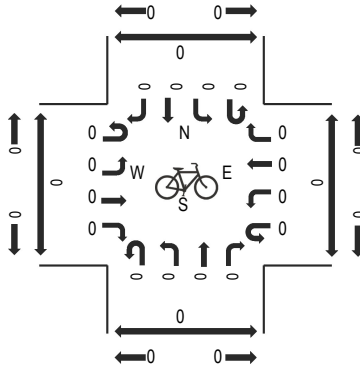
Traffic Counts - Motorized Vehicles

Interval Start Time	KIERLAND BLVD Eastbound				KIERLAND BLVD Westbound				SCOTTSDALE RD Northbound				SCOTTSDALE RD Southbound				Total	Rolling Hour	Pedestrian Crossings			
	U-Turn	Left	Thru	Right	U-Turn	Left	Thru	Right	U-Turn	Left	Thru	Right	U-Turn	Left	Thru	Right			West	East	South	North
4:00 PM	1	36	38	24	2	54	66	23	3	14	311	57	1	40	215	51	936	3,664	2	4	0	1
4:15 PM	0	41	32	10	0	67	82	25	2	18	257	60	1	30	206	60	891	3,840	2	2	2	1
4:30 PM	0	29	32	13	1	85	69	28	3	18	277	66	0	46	226	54	947	3,898	3	7	7	7
4:45 PM	0	37	42	22	1	64	82	24	7	20	243	64	0	53	182	49	890	3,869	7	4	7	3
5:00 PM	0	41	53	23	2	112	85	34	3	26	326	69	0	43	242	53	1,112	3,749	2	7	2	2
5:15 PM	0	48	45	12	2	76	96	40	2	28	239	56	3	49	208	45	949		1	7	5	4
5:30 PM	0	46	40	22	2	66	77	19	3	21	289	53	0	40	201	39	918		0	6	2	4
5:45 PM	0	34	46	12	4	67	56	22	2	20	215	52	0	39	163	38	770		1	14	1	10
Count Total	1	312	328	138	14	591	613	215	25	165	2,157	477	5	340	1,643	389	7,413		18	51	26	32
Peak Hour	0	155	172	70	6	337	332	126	15	92	1,085	255	3	191	858	201	3,898		13	25	21	16

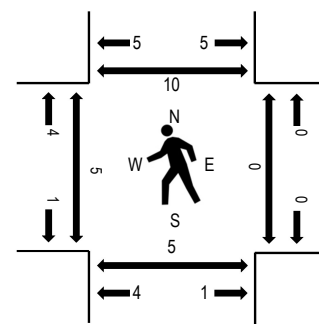
Peak Hour - Motorized Vehicles



Peak Hour - Bicycles



Peak Hour - Pedestrians



Note: Total study counts contained in parentheses.

Traffic Counts - Motorized Vehicles

Interval Start Time	GREENWAY PKWY Eastbound				GREENWAY PKWY Westbound				SCOTTSDALE RD Northbound				SCOTTSDALE RD Southbound				Total	Rolling Hour	Pedestrian Crossings			
	U-Turn	Left	Thru	Right	U-Turn	Left	Thru	Right	U-Turn	Left	Thru	Right	U-Turn	Left	Thru	Right			West	East	South	North
4:00 PM	1	50	52	57	0	64	100	45	0	101	258	49	3	14	215	30	1,039	4,124	0	0	0	3
4:15 PM	0	51	42	52	0	68	80	43	0	66	256	46	2	22	261	26	1,015	4,271	0	0	0	3
4:30 PM	1	66	46	47	0	62	88	44	0	102	262	50	6	20	236	31	1,061	4,328	1	0	3	1
4:45 PM	0	52	47	38	0	68	70	50	0	76	251	59	3	15	237	43	1,009	4,319	0	0	1	1
5:00 PM	0	63	48	41	0	83	128	50	0	116	279	52	4	21	264	37	1,186	4,202	4	0	0	1
5:15 PM	1	31	45	44	0	65	85	55	0	92	263	58	3	21	267	42	1,072		0	0	1	7
5:30 PM	1	56	48	60	0	63	87	40	0	86	272	68	3	22	208	38	1,052		0	0	1	1
5:45 PM	0	40	43	42	0	48	59	26	0	64	248	57	6	21	212	26	892		1	0	0	0
Count Total	4	409	371	381	0	521	697	353	0	703	2,089	439	30	156	1,900	273	8,326		6	0	6	17
Peak Hour	2	212	186	170	0	278	371	199	0	386	1,055	219	16	77	1,004	153	4,328		5	0	5	10

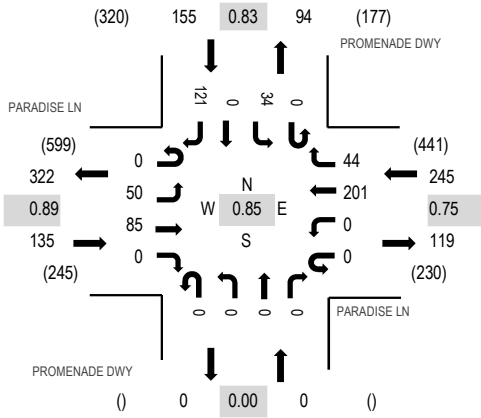
Location: 7 PROMENADE DWY & PARADISE LN PM

Date: Tuesday, May 10, 2022

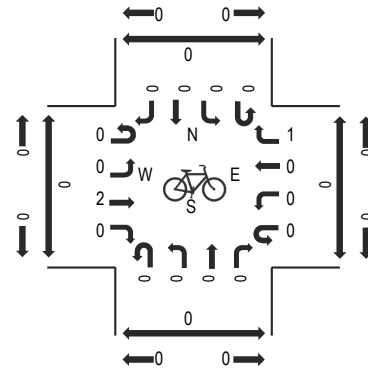
Peak Hour: 04:00 PM - 05:00 PM

Peak 15-Minutes: 04:00 PM - 04:15 PM

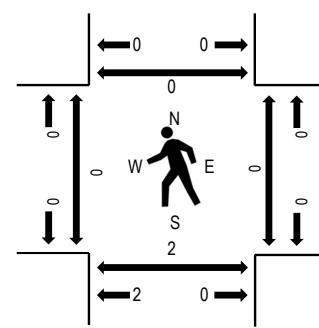
Peak Hour - Motorized Vehicles



Peak Hour - Bicycles



Peak Hour - Pedestrians

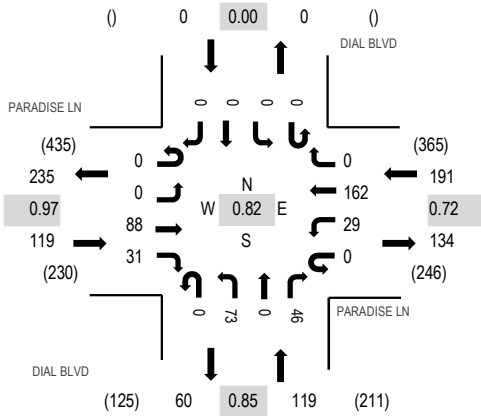


Note: Total study counts contained in parentheses.

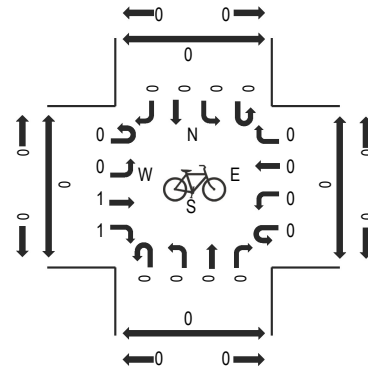
Traffic Counts - Motorized Vehicles

Interval Start Time	PARADISE LN Eastbound				PARADISE LN Westbound				PROMENADE DWY Northbound				PROMENADE DWY Southbound				Total	Rolling Hour	Pedestrian Crossings			
	U-Turn	Left	Thru	Right	U-Turn	Left	Thru	Right	U-Turn	Left	Thru	Right	U-Turn	Left	Thru	Right			West	East	South	North
4:00 PM	0	12	26	0	0	0	67	15	0	0	0	0	0	12	0	26	158	535	0	0	0	0
4:15 PM	0	10	19	0	0	0	42	6	0	0	0	0	0	5	0	36	118	518	0	0	2	0
4:30 PM	0	13	23	0	0	0	43	14	0	0	0	0	0	8	0	33	134	514	0	0	0	0
4:45 PM	0	15	17	0	0	0	49	9	0	0	0	0	0	9	0	26	125	504	0	0	0	0
5:00 PM	0	13	22	0	0	0	55	14	0	0	0	0	0	7	0	30	141	471	0	0	1	0
5:15 PM	0	8	20	0	0	0	35	10	0	0	0	0	0	10	0	31	114		0	0	0	1
5:30 PM	0	13	12	0	0	0	39	10	0	0	0	0	0	16	0	34	124		0	0	0	0
5:45 PM	0	7	15	0	0	0	25	8	0	0	0	0	0	9	0	28	92		0	0	0	0
Count Total	0	91	154	0	0	0	355	86	0	0	0	0	0	76	0	244	1,006		0	0	3	1
Peak Hour	0	50	85	0	0	0	201	44	0	0	0	0	0	34	0	121	535		0	0	2	0

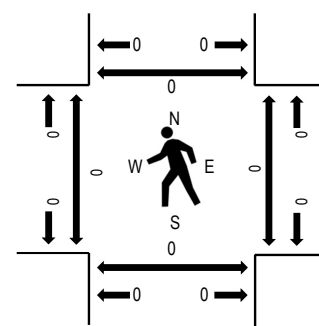
Peak Hour - Motorized Vehicles



Peak Hour - Bicycles



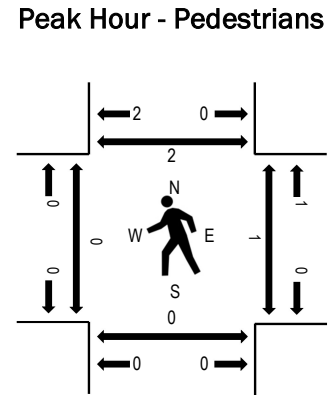
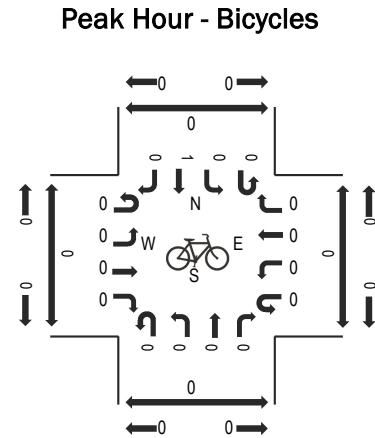
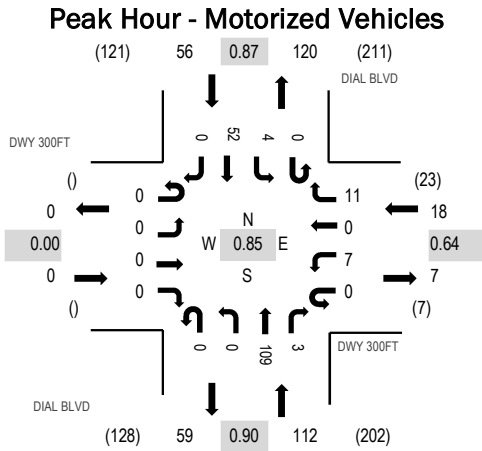
Peak Hour - Pedestrians



Note: Total study counts contained in parentheses.

Traffic Counts - Motorized Vehicles

Interval Start Time	PARADISE LN Eastbound				PARADISE LN Westbound				DIAL BLVD Northbound				DIAL BLVD Southbound				Total	Rolling Hour	Pedestrian Crossings			
	U-Turn	Left	Thru	Right	U-Turn	Left	Thru	Right	U-Turn	Left	Thru	Right	U-Turn	Left	Thru	Right			West	East	South	North
4:00 PM	0	0	27	11	0	6	52	0	0	23	0	12	0	0	0	0	131	429	0	0	0	0
4:15 PM	0	0	20	2	0	6	37	0	0	13	0	13	0	0	0	0	91	416	0	0	0	0
4:30 PM	0	0	20	11	0	8	36	0	0	20	0	11	0	0	0	0	106	421	0	0	0	0
4:45 PM	0	0	21	7	0	9	37	0	0	17	0	10	0	0	0	0	101	406	0	0	0	0
5:00 PM	0	0	26	4	0	10	61	0	0	11	0	6	0	0	0	0	118	377	0	1	1	1
5:15 PM	0	0	19	12	0	6	31	0	0	16	0	12	0	0	0	0	96		0	1	1	0
5:30 PM	0	0	18	10	0	5	33	0	0	14	0	11	0	0	0	0	91		0	0	0	0
5:45 PM	0	0	10	12	0	6	22	0	0	12	0	10	0	0	0	0	72		0	0	0	0
Count Total	0	0	161	69	0	56	309	0	0	126	0	85	0	0	0	0	806		0	2	2	1
Peak Hour	0	0	88	31	0	29	162	0	0	73	0	46	0	0	0	0	429		0	0	0	0

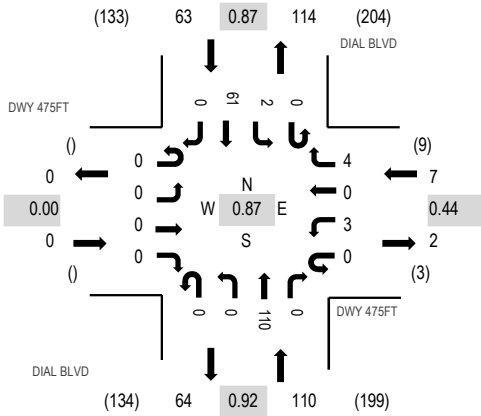


Note: Total study counts contained in parentheses.

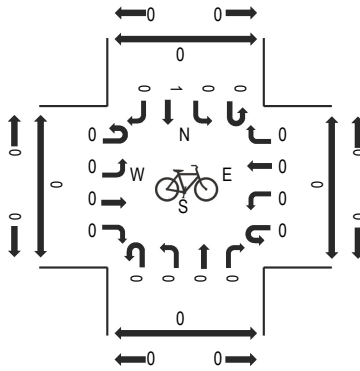
Traffic Counts - Motorized Vehicles

Interval Start Time	DWY 300FT Eastbound				DWY 300FT Westbound				DIAL BLVD Northbound				DIAL BLVD Southbound				Total	Rolling Hour	Pedestrian Crossings			
	U-Turn	Left	Thru	Right	U-Turn	Left	Thru	Right	U-Turn	Left	Thru	Right	U-Turn	Left	Thru	Right			West	East	South	North
4:00 PM	0	0	0	0	0	2	0	4	0	0	31	0	0	2	12	0	51	186	0	0	0	0
4:15 PM	0	0	0	0	0	1	0	2	0	0	24	1	0	0	7	0	35	169	0	1	0	2
4:30 PM	0	0	0	0	0	3	0	4	0	0	28	1	0	1	18	0	55	179	0	0	0	0
4:45 PM	0	0	0	0	0	1	0	1	0	0	26	1	0	1	15	0	45	164	0	0	0	0
5:00 PM	0	0	0	0	0	3	0	1	0	0	16	0	0	0	14	0	34	160	0	2	0	0
5:15 PM	0	0	0	0	0	1	0	0	0	0	27	0	0	0	17	0	45		2	2	0	0
5:30 PM	0	0	0	0	0	0	0	0	0	0	25	0	0	0	15	0	40		0	0	0	0
5:45 PM	0	0	0	0	0	0	0	0	0	0	22	0	0	0	19	0	41		0	0	0	0
Count Total	0	0	0	0	0	11	0	12	0	0	199	3	0	4	117	0	346		2	5	0	2
Peak Hour	0	0	0	0	0	7	0	11	0	0	109	3	0	4	52	0	186		0	1	0	2

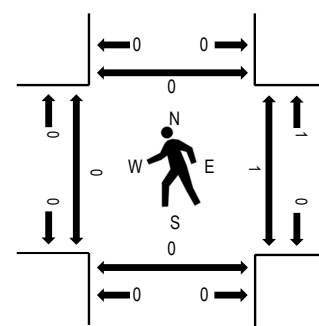
Peak Hour - Motorized Vehicles



Peak Hour - Bicycles



Peak Hour - Pedestrians

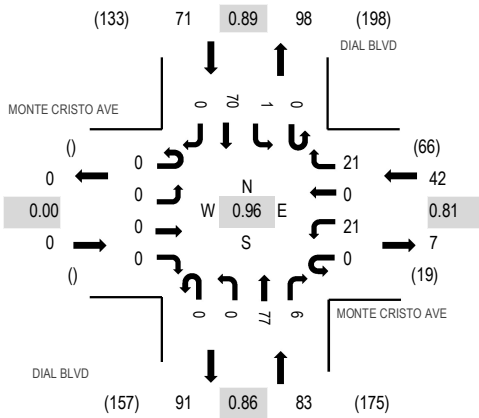


Note: Total study counts contained in parentheses.

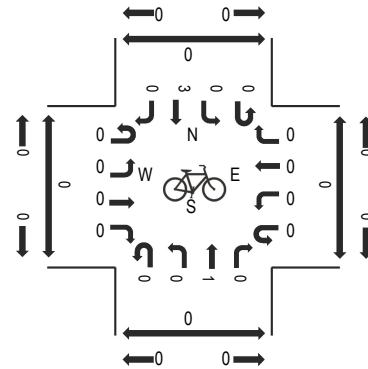
Traffic Counts - Motorized Vehicles

Interval Start Time	DWY 475FT Eastbound				DWY 475FT Westbound				DIAL BLVD Northbound				DIAL BLVD Southbound				Total	Rolling Hour	Pedestrian Crossings			
	U-Turn	Left	Thru	Right	U-Turn	Left	Thru	Right	U-Turn	Left	Thru	Right	U-Turn	Left	Thru	Right			West	East	South	North
4:00 PM	0	0	0	0	0	2	0	2	0	0	30	0	0	0	17	0	51	180	0	0	0	0
4:15 PM	0	0	0	0	0	1	0	1	0	0	23	0	0	1	8	0	34	163	0	1	0	0
4:30 PM	0	0	0	0	0	0	0	1	0	0	30	0	0	1	20	0	52	175	0	0	0	0
4:45 PM	0	0	0	0	0	0	0	0	0	0	27	0	0	0	16	0	43	163	0	0	0	0
5:00 PM	0	0	0	0	0	0	0	0	0	0	16	1	0	0	17	0	34	161	0	2	0	0
5:15 PM	0	0	0	0	0	0	0	2	0	0	25	0	0	0	19	0	46		2	2	0	0
5:30 PM	0	0	0	0	0	0	0	0	0	0	25	0	0	0	15	0	40		0	0	0	0
5:45 PM	0	0	0	0	0	0	0	0	0	0	22	0	0	0	19	0	41		0	0	0	0
Count Total	0	0	0	0	0	3	0	6	0	0	198	1	0	2	131	0	341		2	5	0	0
Peak Hour	0	0	0	0	0	3	0	4	0	0	110	0	0	2	61	0	180		0	1	0	0

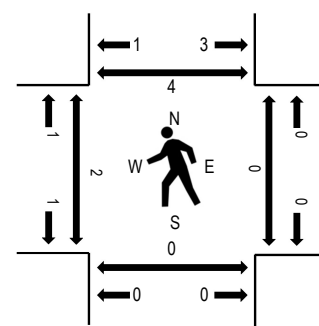
Peak Hour - Motorized Vehicles



Peak Hour - Bicycles



Peak Hour - Pedestrians

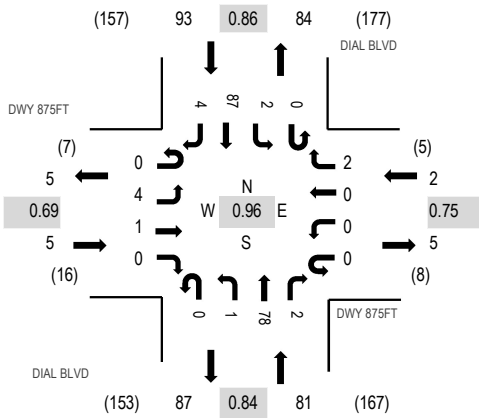


Note: Total study counts contained in parentheses.

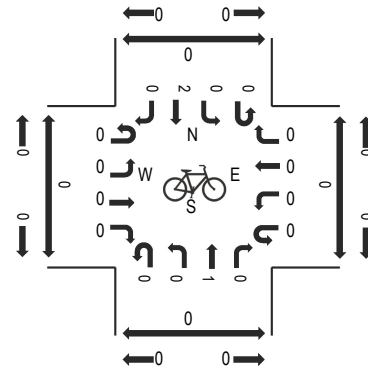
Traffic Counts - Motorized Vehicles

Interval Start Time	MONTE CRISTO AVE Eastbound				MONTE CRISTO AVE Westbound				DIAL BLVD Northbound				DIAL BLVD Southbound				Total	Rolling Hour	Pedestrian Crossings			
	U-Turn	Left	Thru	Right	U-Turn	Left	Thru	Right	U-Turn	Left	Thru	Right	U-Turn	Left	Thru	Right			West	East	South	North
4:00 PM	0	0	0	0	0	1	0	4	0	0	25	3	0	3	16	0	52	192	0	0	0	0
4:15 PM	0	0	0	0	0	3	0	1	0	0	23	2	0	0	10	0	39	186	1	0	0	1
4:30 PM	0	0	0	0	0	3	0	7	0	0	21	0	0	0	20	0	51	196	0	0	0	0
4:45 PM	0	0	0	0	0	6	0	7	0	0	21	1	0	0	15	0	50	188	1	0	0	0
5:00 PM	0	0	0	0	0	8	0	5	0	0	12	4	0	0	17	0	46	182	0	0	0	2
5:15 PM	0	0	0	0	0	4	0	2	0	0	23	1	0	1	18	0	49		1	0	0	2
5:30 PM	0	0	0	0	0	2	0	5	0	0	21	0	0	0	15	0	43		1	0	0	0
5:45 PM	0	0	0	0	0	4	0	4	0	0	17	1	0	3	15	0	44		2	0	0	0
Count Total	0	0	0	0	0	31	0	35	0	0	163	12	0	7	126	0	374		6	0	0	5
Peak Hour	0	0	0	0	0	21	0	21	0	0	77	6	0	1	70	0	196		2	0	0	4

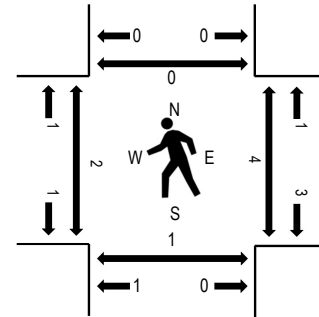
Peak Hour - Motorized Vehicles



Peak Hour - Bicycles



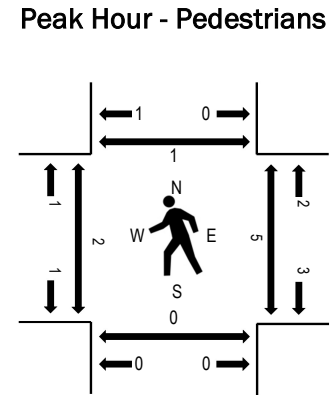
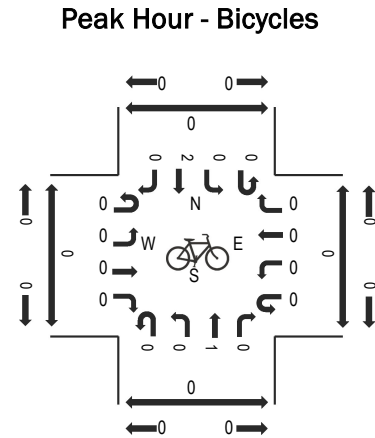
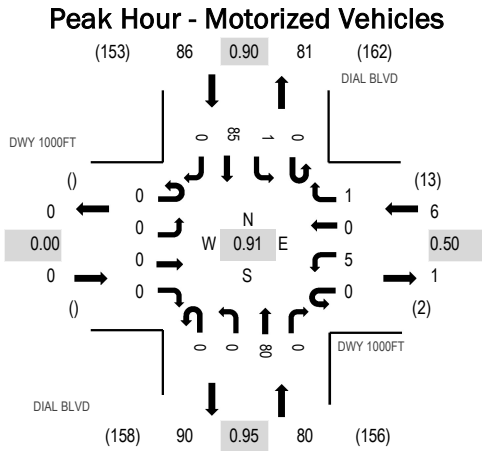
Peak Hour - Pedestrians



Note: Total study counts contained in parentheses.

Traffic Counts - Motorized Vehicles

Interval Start Time	DWY 875FT Eastbound				DWY 875FT Westbound				DIAL BLVD Northbound				DIAL BLVD Southbound				Total	Rolling Hour	Pedestrian Crossings				
	U-Turn	Left	Thru	Right	U-Turn	Left	Thru	Right	U-Turn	Left	Thru	Right	U-Turn	Left	Thru	Right			West	East	South	North	
4:00 PM	0	2	0	1	0	0	0	0	0	0	28	0	0	0	1	16	0	48	174	0	0	0	0
4:15 PM	0	0	0	1	0	0	0	1	0	0	22	1	0	1	9	1	36	170	0	2	0	0	
4:30 PM	0	0	0	0	0	0	0	1	0	0	21	1	0	0	24	0	47	181	0	0	0	0	
4:45 PM	0	1	0	0	0	0	0	0	0	0	21	0	0	0	20	1	43	171	0	0	0	0	
5:00 PM	0	1	1	0	0	0	0	0	0	0	15	0	0	0	25	2	44	171	0	1	0	0	
5:15 PM	0	2	0	0	0	0	0	1	0	1	21	1	0	2	18	1	47		2	3	1	0	
5:30 PM	0	2	0	1	0	0	0	1	0	0	17	0	0	0	16	0	37		0	0	0	0	
5:45 PM	0	1	0	3	0	0	0	1	0	0	18	0	0	0	19	1	43		0	0	0	0	
Count Total	0	9	1	6	0	0	0	5	0	1	163	3	0	4	147	6	345		2	6	1	0	
Peak Hour	0	4	1	0	0	0	0	2	0	1	78	2	0	2	87	4	181		2	4	1	0	

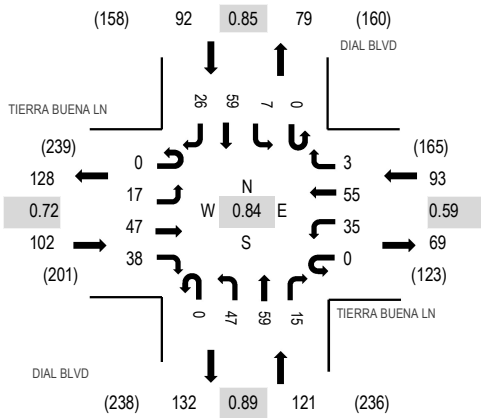


Note: Total study counts contained in parentheses.

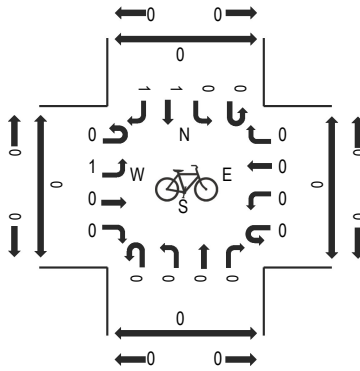
Traffic Counts - Motorized Vehicles

Interval Start Time	DWY 1000FT Eastbound				DWY 1000FT Westbound				DIAL BLVD Northbound				DIAL BLVD Southbound				Total	Rolling Hour	Pedestrian Crossings			
	U-Turn	Left	Thru	Right	U-Turn	Left	Thru	Right	U-Turn	Left	Thru	Right	U-Turn	Left	Thru	Right			West	East	South	North
4:00 PM	0	0	0	0	0	0	0	2	0	0	22	0	0	0	17	0	41	163	1	0	0	0
4:15 PM	0	0	0	0	0	0	0	3	0	0	21	0	0	1	11	0	36	161	0	2	0	0
4:30 PM	0	0	0	0	0	0	0	0	0	0	22	0	0	1	23	0	46	172	0	0	0	0
4:45 PM	0	0	0	0	0	1	0	0	0	0	19	0	0	0	20	0	40	162	0	0	0	0
5:00 PM	0	0	0	0	0	1	0	0	0	0	15	0	0	0	23	0	39	159	0	1	0	0
5:15 PM	0	0	0	0	0	3	0	1	0	0	24	0	0	0	19	0	47		2	4	0	1
5:30 PM	0	0	0	0	0	2	0	0	0	0	16	0	0	0	18	0	36		0	0	0	0
5:45 PM	0	0	0	0	0	0	0	0	0	0	17	0	0	0	20	0	37		0	0	0	0
Count Total	0	0	0	0	0	7	0	6	0	0	156	0	0	2	151	0	322		3	7	0	1
Peak Hour	0	0	0	0	0	5	0	1	0	0	80	0	0	1	85	0	172		2	5	0	1

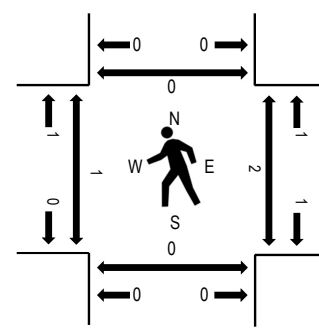
Peak Hour - Motorized Vehicles



Peak Hour - Bicycles



Peak Hour - Pedestrians



Note: Total study counts contained in parentheses.

Traffic Counts - Motorized Vehicles

Interval Start Time	TIERRA BUENA LN Eastbound				TIERRA BUENA LN Westbound				DIAL BLVD Northbound				DIAL BLVD Southbound				Total	Rolling Hour	Pedestrian Crossings			
	U-Turn	Left	Thru	Right	U-Turn	Left	Thru	Right	U-Turn	Left	Thru	Right	U-Turn	Left	Thru	Right			West	East	South	North
4:00 PM	0	3	13	19	0	13	25	3	0	12	18	5	0	2	9	7	129	405	1	0	0	0
4:15 PM	0	6	8	10	0	4	7	1	0	15	15	1	0	2	4	2	75	398	1	1	0	0
4:30 PM	0	4	7	4	0	9	14	1	0	10	15	2	0	0	17	7	90	408	0	0	0	0
4:45 PM	0	5	23	11	0	7	11	2	0	13	15	3	0	1	13	7	111	391	0	0	0	0
5:00 PM	0	3	12	13	0	13	21	0	0	15	12	6	0	1	17	9	122	355	0	0	0	0
5:15 PM	0	5	5	10	0	6	9	0	0	9	17	4	0	5	12	3	85		1	2	0	0
5:30 PM	0	7	3	11	0	2	7	0	0	13	11	0	0	1	15	3	73		0	1	0	0
5:45 PM	0	3	11	5	0	3	6	1	0	8	13	4	0	4	11	6	75		1	0	0	0
Count Total	0	36	82	83	0	57	100	8	0	95	116	25	0	16	98	44	760		4	4	0	0
Peak Hour	0	17	47	38	0	35	55	3	0	47	59	15	0	7	59	26	408		1	2	0	0

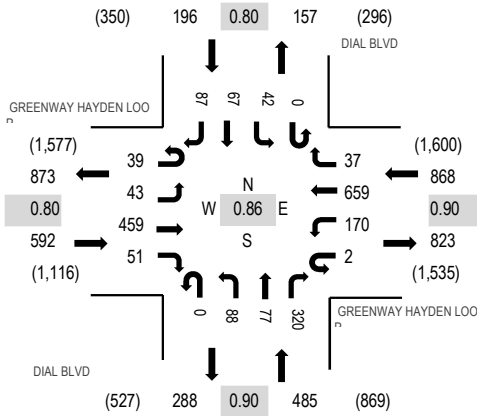
Location: 15 DIAL BLVD & GREENWAY HAYDEN LOOP PM

Date: Tuesday, May 10, 2022

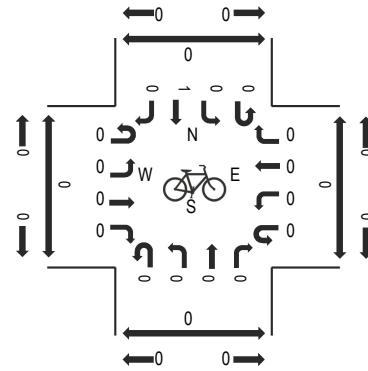
Peak Hour: 04:30 PM - 05:30 PM

Peak 15-Minutes: 05:00 PM - 05:15 PM

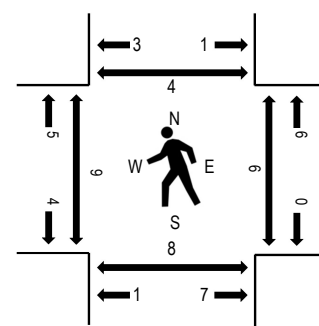
Peak Hour - Motorized Vehicles



Peak Hour - Bicycles



Peak Hour - Pedestrians

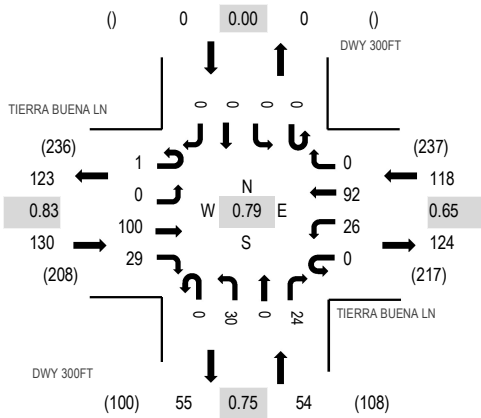


Note: Total study counts contained in parentheses.

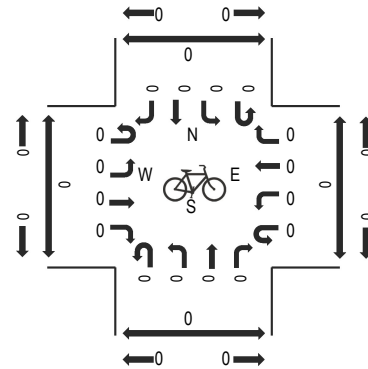
Traffic Counts - Motorized Vehicles

Interval Start Time	GREENWAY HAYDEN Eastbound				GREENWAY HAYDEN Westbound				DIAL BLVD Northbound			DIAL BLVD Southbound				Total	Rolling Hour	Pedestrian Crossings				
	U-Turn	Left	Thru	Right	U-Turn	Left	Thru	Right	U-Turn	Left	Thru	Right	U-Turn	Left	Thru			Right	West	East	South	North
4:00 PM	4	8	111	11	0	27	147	14	0	8	27	87	0	15	21	17	497	1,923	7	1	1	3
4:15 PM	14	10	93	10	3	51	144	10	0	13	15	64	0	14	9	12	462	2,047	2	1	0	0
4:30 PM	13	12	103	14	0	43	157	8	0	23	17	74	0	7	17	15	503	2,141	0	2	1	0
4:45 PM	6	10	102	9	1	42	135	8	0	15	21	71	0	9	15	17	461	2,074	2	1	2	2
5:00 PM	11	11	147	15	0	44	188	8	0	28	17	90	0	15	17	30	621	2,012	2	3	4	2
5:15 PM	9	10	107	13	1	41	179	13	0	22	22	85	0	11	18	25	556		5	0	1	0
5:30 PM	9	8	93	11	0	34	137	7	0	18	17	61	0	8	14	19	436		9	3	3	0
5:45 PM	16	10	104	12	0	26	129	3	0	9	10	55	0	4	13	8	399		4	0	0	2
Count Total	82	79	860	95	5	308	1,216	71	0	136	146	587	0	83	124	143	3,935		31	11	12	9
Peak Hour	39	43	459	51	2	170	659	37	0	88	77	320	0	42	67	87	2,141		9	6	8	4

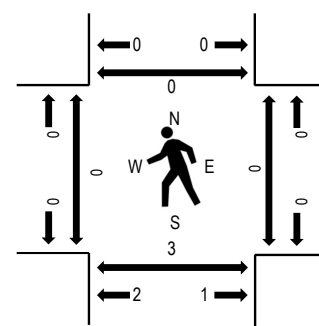
Peak Hour - Motorized Vehicles



Peak Hour - Bicycles



Peak Hour - Pedestrians

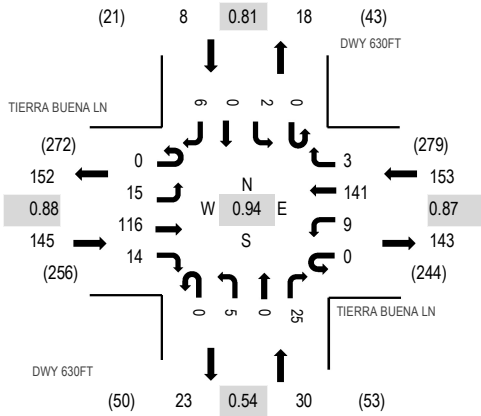


Note: Total study counts contained in parentheses.

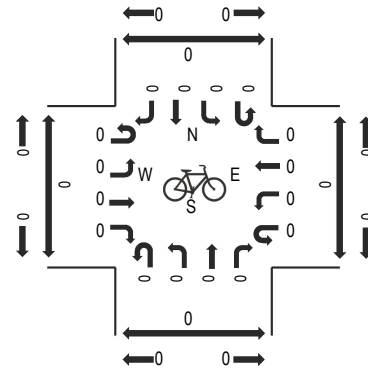
Traffic Counts - Motorized Vehicles

Interval Start Time	TIERRA BUENA LN Eastbound				TIERRA BUENA LN Westbound				DWY 300FT Northbound				DWY 300FT Southbound				Total	Rolling Hour	Pedestrian Crossings			
	U-Turn	Left	Thru	Right	U-Turn	Left	Thru	Right	U-Turn	Left	Thru	Right	U-Turn	Left	Thru	Right			West	East	South	North
4:00 PM	0	0	31	8	0	8	32	0	0	10	0	6	0	0	0	0	95	302	0	0	1	0
4:15 PM	1	0	16	8	0	3	20	0	0	5	0	11	0	0	0	0	64	298	0	0	2	0
4:30 PM	0	0	24	7	0	6	23	0	0	6	0	2	0	0	0	0	68	291	0	0	0	0
4:45 PM	0	0	29	6	0	9	17	0	0	9	0	5	0	0	0	0	75	279	0	0	0	0
5:00 PM	0	0	19	2	0	16	33	0	0	11	0	10	0	0	0	0	91	251	0	0	1	0
5:15 PM	0	0	16	4	0	7	17	0	0	7	0	6	0	0	0	0	57		0	0	1	0
5:30 PM	0	0	11	5	0	4	21	0	0	5	0	10	0	0	0	0	56		0	0	0	0
5:45 PM	0	0	19	2	0	5	16	0	0	3	0	2	0	0	0	0	47		0	0	0	0
Count Total	1	0	165	42	0	58	179	0	0	56	0	52	0	0	0	0	553		0	0	5	0
Peak Hour	1	0	100	29	0	26	92	0	0	30	0	24	0	0	0	0	302		0	0	3	0

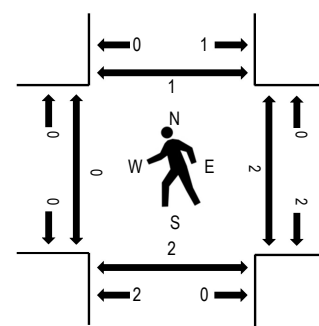
Peak Hour - Motorized Vehicles



Peak Hour - Bicycles



Peak Hour - Pedestrians

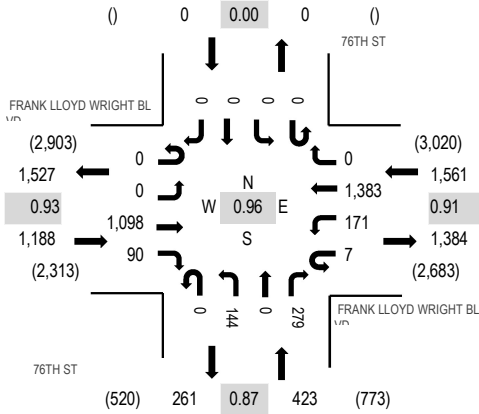


Note: Total study counts contained in parentheses.

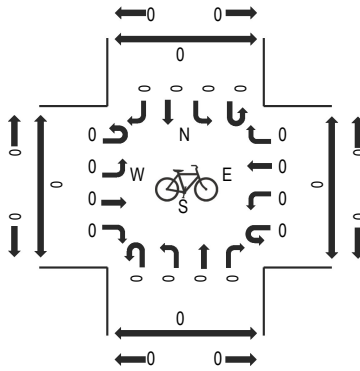
Traffic Counts - Motorized Vehicles

Interval Start Time	TIERRA BUENA LN Eastbound				TIERRA BUENA LN Westbound				DWY 630FT Northbound				DWY 630FT Southbound				Total	Rolling Hour	Pedestrian Crossings			
	U-Turn	Left	Thru	Right	U-Turn	Left	Thru	Right	U-Turn	Left	Thru	Right	U-Turn	Left	Thru	Right			West	East	South	North
4:00 PM	0	2	18	3	0	2	38	1	0	1	0	4	0	0	0	1	70	317	0	0	0	0
4:15 PM	0	1	29	5	0	0	26	0	0	2	0	12	0	0	0	2	77	336	0	0	0	0
4:30 PM	0	6	23	4	0	2	38	1	0	3	0	3	0	1	0	1	82	319	0	0	0	0
4:45 PM	0	2	36	3	0	1	40	1	0	0	0	2	0	1	0	2	88	304	0	0	0	0
5:00 PM	0	6	28	2	0	6	37	1	0	0	0	8	0	0	0	1	89	292	0	2	2	1
5:15 PM	0	5	21	1	0	6	17	0	0	4	0	2	0	1	0	3	60		0	0	2	0
5:30 PM	0	12	13	2	0	5	25	2	0	2	0	2	0	2	0	2	67		0	0	0	0
5:45 PM	0	1	31	2	0	6	22	2	0	1	0	7	0	0	0	4	76		0	0	0	0
Count Total	0	35	199	22	0	28	243	8	0	13	0	40	0	5	0	16	609		0	2	4	1
Peak Hour	0	15	116	14	0	9	141	3	0	5	0	25	0	2	0	6	336		0	2	2	1

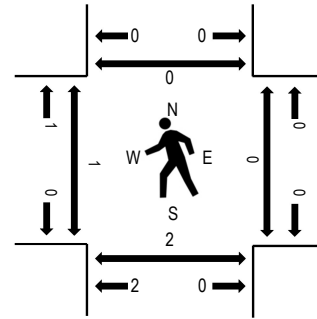
Peak Hour - Motorized Vehicles



Peak Hour - Bicycles



Peak Hour - Pedestrians

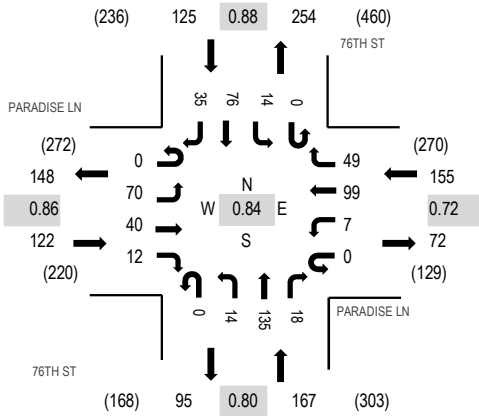


Note: Total study counts contained in parentheses.

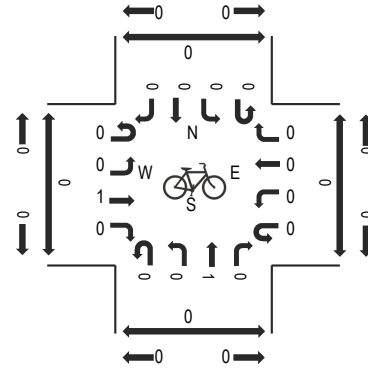
Traffic Counts - Motorized Vehicles

Interval Start Time	FRANK LLOYD WRIGHT Blvd Eastbound				FRANK LLOYD WRIGHT Blvd Westbound				76TH ST Northbound			76TH ST Southbound				Total	Rolling Hour	Pedestrian Crossings				
	U-Turn	Left	Thru	Right	U-Turn	Left	Thru	Right	U-Turn	Left	Thru	Right	U-Turn	Left	Thru			Right	West	East	South	North
4:00 PM	0	0	280	21	0	51	329	0	0	37	0	78	0	0	0	0	796	3,159	0	0	0	0
4:15 PM	0	0	302	17	0	43	362	0	0	34	0	72	0	0	0	0	830	3,172	0	0	0	0
4:30 PM	0	0	249	21	1	38	328	0	0	30	0	61	0	0	0	0	728	3,157	0	0	0	0
4:45 PM	0	0	266	25	2	37	371	0	0	30	0	74	0	0	0	0	805	3,072	1	0	1	0
5:00 PM	0	0	281	27	4	53	322	0	0	50	0	72	0	0	0	0	809	2,947	0	0	1	0
5:15 PM	0	0	277	13	0	53	388	0	0	25	0	59	0	0	0	0	815		0	0	0	0
5:30 PM	0	0	225	9	1	42	288	0	0	23	0	55	0	0	0	0	643		0	0	1	0
5:45 PM	0	0	278	22	0	48	259	0	0	27	0	46	0	0	0	0	680		0	0	0	0
Count Total	0	0	2,158	155	8	365	2,647	0	0	256	0	517	0	0	0	0	6,106		1	0	3	0
Peak Hour	0	0	1,098	90	7	171	1,383	0	0	144	0	279	0	0	0	0	3,172		1	0	2	0

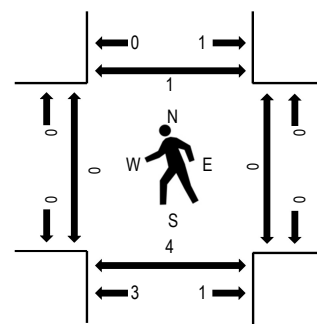
Peak Hour - Motorized Vehicles



Peak Hour - Bicycles



Peak Hour - Pedestrians

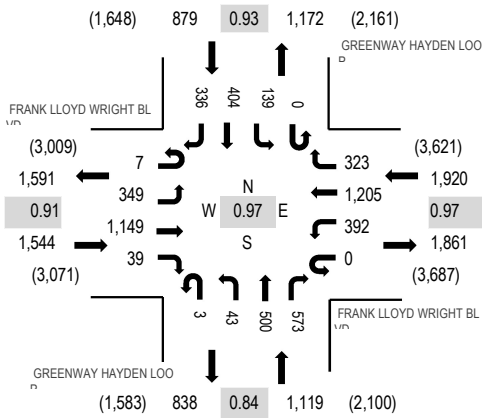


Note: Total study counts contained in parentheses.

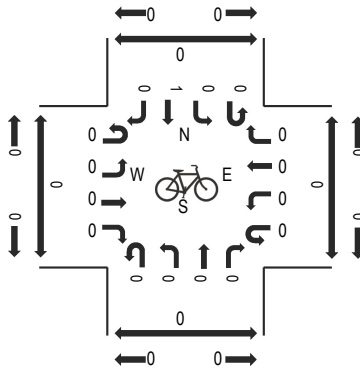
Traffic Counts - Motorized Vehicles

Interval Start Time	PARADISE LN Eastbound				PARADISE LN Westbound				76TH ST Northbound				76TH ST Southbound				Total	Rolling Hour	Pedestrian Crossings			
	U-Turn	Left	Thru	Right	U-Turn	Left	Thru	Right	U-Turn	Left	Thru	Right	U-Turn	Left	Thru	Right			West	East	South	North
4:00 PM	0	18	16	4	0	0	21	15	0	8	41	1	0	7	14	15	160	559	0	0	0	0
4:15 PM	0	19	10	2	0	3	24	10	0	2	25	6	0	3	21	8	133	569	0	0	1	0
4:30 PM	0	16	13	0	0	1	23	9	0	7	34	2	0	1	15	8	129	547	0	0	1	1
4:45 PM	0	19	6	7	0	0	20	11	0	4	30	5	0	5	22	8	137	520	0	0	1	0
5:00 PM	0	16	11	3	0	3	32	19	0	1	46	5	0	5	18	11	170	470	0	0	1	0
5:15 PM	0	19	8	0	0	2	20	13	0	3	21	3	0	2	14	6	111		0	0	1	0
5:30 PM	0	10	8	3	0	0	21	5	0	2	30	1	0	1	13	8	102		0	0	1	0
5:45 PM	0	6	4	2	0	2	11	5	0	1	23	2	0	4	19	8	87		0	0	0	0
Count Total	0	123	76	21	0	11	172	87	0	28	250	25	0	28	136	72	1,029		0	0	6	1
Peak Hour	0	70	40	12	0	7	99	49	0	14	135	18	0	14	76	35	569		0	0	4	1

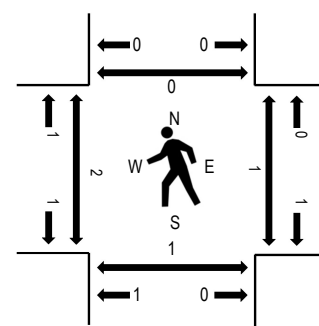
Peak Hour - Motorized Vehicles



Peak Hour - Bicycles



Peak Hour - Pedestrians



Note: Total study counts contained in parentheses.

Traffic Counts - Motorized Vehicles

Interval Start Time	FRANK LLOYD WRIGHT Blvd Eastbound				FRANK LLOYD WRIGHT Blvd Westbound				GREENWAY HAYDEN LOOP Northbound				GREENWAY HAYDEN LOOP Southbound				Total	Rolling Hour	Pedestrian Crossings			
	U-Turn	Left	Thru	Right	U-Turn	Left	Thru	Right	U-Turn	Left	Thru	Right	U-Turn	Left	Thru	Right			West	East	South	North
4:00 PM	1	95	334	14	0	103	324	67	0	14	111	149	0	33	69	62	1,376	5,381	0	2	0	0
4:15 PM	6	75	316	8	0	105	273	73	1	9	125	136	0	36	108	89	1,360	5,413	0	0	0	0
4:30 PM	5	80	295	12	0	93	315	87	2	8	103	136	0	34	84	79	1,333	5,462	0	0	0	0
4:45 PM	1	90	271	11	0	103	280	62	0	11	116	137	0	34	106	90	1,312	5,298	0	0	0	0
5:00 PM	1	93	329	3	0	95	312	88	0	10	120	142	0	38	101	76	1,408	5,059	0	1	0	0
5:15 PM	0	86	254	13	0	101	298	86	1	14	161	158	0	33	113	91	1,409	2	0	1	0	
5:30 PM	1	81	251	7	0	82	279	59	0	8	93	131	0	37	80	60	1,169	0	0	0	0	
5:45 PM	2	73	258	5	0	74	214	48	0	6	89	109	0	36	89	70	1,073	0	0	0	0	
Count Total	17	673	2,308	73	0	756	2,295	570	4	80	918	1,098	0	281	750	617	10,440	2	3	1	0	
Peak Hour	7	349	1,149	39	0	392	1,205	323	3	43	500	573	0	139	404	336	5,462	2	1	1	0	

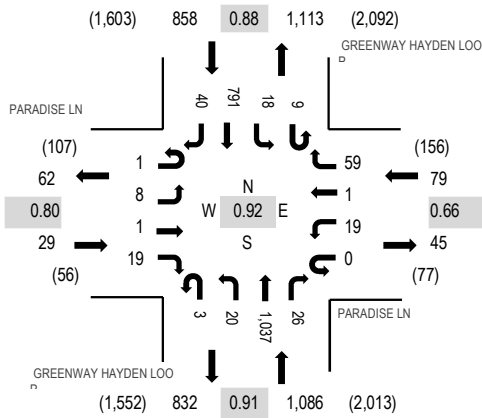
Location: 23 GREENWAY HAYDEN LOOP & PARADISE LN PM

Date: Tuesday, May 10, 2022

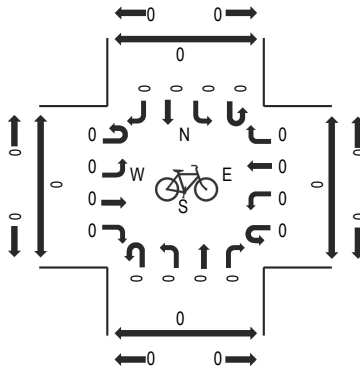
Peak Hour: 04:30 PM - 05:30 PM

Peak 15-Minutes: 05:15 PM - 05:30 PM

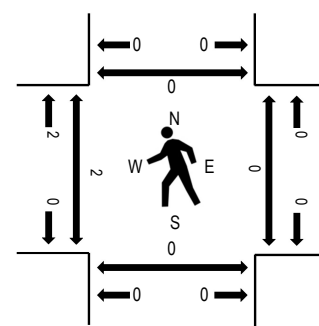
Peak Hour - Motorized Vehicles



Peak Hour - Bicycles



Peak Hour - Pedestrians



Note: Total study counts contained in parentheses.

Traffic Counts - Motorized Vehicles

Interval Start Time	PARADISE LN Eastbound				PARADISE LN Westbound				GREENWAY HAYDEN LOOP Northbound				GREENWAY HAYDEN LOOP Southbound				Total	Rolling Hour	Pedestrian Crossings			
	U-Turn	Left	Thru	Right	U-Turn	Left	Thru	Right	U-Turn	Left	Thru	Right	U-Turn	Left	Thru	Right			West	East	South	North
4:00 PM	0	5	0	2	0	11	1	23	1	6	263	9	0	8	160	9	498	1,943	0	0	0	0
4:15 PM	0	5	0	3	0	3	1	18	0	1	228	4	0	7	209	10	489	1,982	0	0	0	0
4:30 PM	1	4	0	2	0	6	1	15	1	8	237	7	2	5	170	13	472	2,052	0	0	0	0
4:45 PM	0	1	0	6	0	5	0	8	1	1	231	4	4	7	205	11	484	1,986	1	0	0	0
5:00 PM	0	1	1	8	0	5	0	26	1	7	287	5	2	1	184	9	537	1,885	1	0	0	0
5:15 PM	0	2	0	3	0	3	0	10	0	4	282	10	1	5	232	7	559		0	0	0	0
5:30 PM	0	3	0	3	0	2	1	9	2	1	217	0	6	3	153	6	406		0	0	0	0
5:45 PM	0	4	0	2	0	2	0	6	2	3	189	1	3	0	165	6	383		0	0	0	0
Count Total	1	25	1	29	0	37	4	115	8	31	1,934	40	18	36	1,478	71	3,828		2	0	0	0
Peak Hour	1	8	1	19	0	19	1	59	3	20	1,037	26	9	18	791	40	2,052		2	0	0	0



Appendix E – Signal Timing

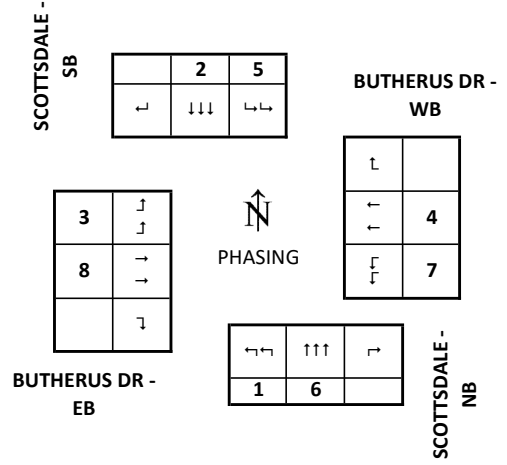
SCOTTSDALE & BUTHERUS DR			System # 161
BASIC TIMING PLAN	Section #	I.P. Address	Date Designed
		MM1-5-1 172.27.11.61	6/5/2020

Phase	1	2	3	4	5	6	7	8
Movement	NBL	SBT	EBL	WBT	SBL	NBT	WBL	EBT
NOTES	PROT	COORD	PROT		L-P	COORD	PROT	
MIN GRN	5	10	5	7	5	10	5	7
BK MGRN								
CS MGRN								
DLY GRN								
WALK		4		4		4		4
WALK2								
WLK MAX								
PED CLR/FDW		28		32		23		26
PD CLR2								
PC MAX								
PED CO								
VEH EXT	2	2	2	2	2	2	2	2
VH EXT2								
MAX 1	20	80	20	40	20	80	15	40
MAX 2								
MAX 3								
DYM MAX	30	100	30	50	30	100	30	50
DYM STP	5	5	5	5	5	5	5	5
YELLOW	4	4.7	4	4	4	4.7	4.0	4
RED CLR	2	1.0	2	1.5	2	1.0	2	1.5
RED MAX								
RED RVT	2	2	2	2	2	2	2	2
ACT B4								
SEC/ACT								
MAX INT								
TIME B4								
CARS WT								
STPTDUC								
TTREDUC								
MIN GAP								
LOCK DET								
VEH RECALL		X				X		
PED RECALL								
MAX RECALL								
SOFT RECALL								
NO REST								
ADD INIT CAL								

TIMING PLAN - MM-2-1

RECALLS - MM-2-8

NOTES	



PHASING SEQUENCES									
TOD: MORNING									
R1	<table border="1"><tr><td>2</td><td>1</td><td>4</td><td>3</td></tr><tr><td>5</td><td>6</td><td>8</td><td>7</td></tr></table>	2	1	4	3	5	6	8	7
2	1	4	3						
5	6	8	7						
R2	<table border="1"><tr><td>2</td><td>1</td><td>4</td><td>3</td></tr><tr><td>5</td><td>6</td><td>8</td><td>7</td></tr></table>	2	1	4	3	5	6	8	7
2	1	4	3						
5	6	8	7						
Use Timing plan:									
TOD: MIDDAY									
R1	<table border="1"><tr><td>2</td><td>1</td><td>4</td><td>3</td></tr><tr><td>5</td><td>6</td><td>8</td><td>7</td></tr></table>	2	1	4	3	5	6	8	7
2	1	4	3						
5	6	8	7						
R2	<table border="1"><tr><td>2</td><td>1</td><td>4</td><td>3</td></tr><tr><td>5</td><td>6</td><td>8</td><td>7</td></tr></table>	2	1	4	3	5	6	8	7
2	1	4	3						
5	6	8	7						
Use Timing plan:									
TOD: EVENING									
R1	<table border="1"><tr><td>2</td><td>1</td><td>4</td><td>3</td></tr><tr><td>5</td><td>6</td><td>8</td><td>7</td></tr></table>	2	1	4	3	5	6	8	7
2	1	4	3						
5	6	8	7						
R2	<table border="1"><tr><td>2</td><td>1</td><td>4</td><td>3</td></tr><tr><td>5</td><td>6</td><td>8</td><td>7</td></tr></table>	2	1	4	3	5	6	8	7
2	1	4	3						
5	6	8	7						
Use Timing plan:									
TOD: NIGHT									
R1	<table border="1"><tr><td>2</td><td>1</td><td>4</td><td>3</td></tr><tr><td>5</td><td>6</td><td>8</td><td>7</td></tr></table>	2	1	4	3	5	6	8	7
2	1	4	3						
5	6	8	7						
R2	<table border="1"><tr><td>2</td><td>1</td><td>4</td><td>3</td></tr><tr><td>5</td><td>6</td><td>8</td><td>7</td></tr></table>	2	1	4	3	5	6	8	7
2	1	4	3						
5	6	8	7						
Use Timing plan:									
FREE									
R1	<table border="1"><tr><td>2</td><td>1</td><td>4</td><td>3</td></tr><tr><td>5</td><td>6</td><td>8</td><td>7</td></tr></table>	2	1	4	3	5	6	8	7
2	1	4	3						
5	6	8	7						
R2	<table border="1"><tr><td>2</td><td>1</td><td>4</td><td>3</td></tr><tr><td>5</td><td>6</td><td>8</td><td>7</td></tr></table>	2	1	4	3	5	6	8	7
2	1	4	3						
5	6	8	7						
Use Timing plan: 254									

Approved By
Effective Date

SCOTTSDALE & BUTHERUS DR

System #

161

COORDINATOR

Section #

0

Date Updated

6/5/2020

PHASE	1	2	3	4	5	6	7	8
FDW		28		32		23		26
YELLOW	4	4.7	4	4	4	4.7	4	4
ALL RED	2	1	2	1.5	2	1	2	1.5
WALK		28		32		23		26

PLAN 1 AM PLAN OPERATIVE TIMES 6:00	R1	2	↓	1	↶	4	←	3	↑	COORD PATTERN	OFFSET
	R2	5	↷	6	↑	8	→	7	↓	Balanced	53
		RING 1				RING 2					
	PHASE	1	2	3	4	5	6	7	8		
	SPLIT	18	58	26	18	12	64	12	32	Target Cycle Length	
	COORD		X				X			120	
	RECALLS		V				V			Actual Cycle Length	
	GREEN	12.0	52.3	20.0	12.5	6.0	58.3	6.0	26.5	120	

PLAN 2 MIDDAY PLAN OPERATIVE TIMES 9:00	R1	2	↓	1	↶	4	←	3	↑	COORD PATTERN	OFFSET
	R2	5	↷	6	↑	8	→	7	↓	Balanced	92
		RING 1				RING 2					
	PHASE	1	2	3	4	5	6	7	8		
	SPLIT	16	56	18	18	12	60	16	20	Target Cycle Length	
	COORD		X				X			108	
	RECALLS		V				V			Actual Cycle Length	
	GREEN	10.0	50.3	###	12.5	6.0	54.3	10.0	14.5	108	

PLAN 3 PM PLAN OPERATIVE TIMES 15:00	R1	2	↓	1	↶	4	←	3	↑	COORD PATTERN	OFFSET
	R2	5	↷	6	↑	8	→	7	↓	Balanced	97
		RING 1				RING 2					
	PHASE	1	2	3	4	5	6	7	8		
	SPLIT	26	44	18	32	12	58	24	26	Target Cycle Length	
	COORD		X				X			120	
	RECALLS		V				V			Actual Cycle Length	
	GREEN	20.0	38.3	###	26.5	6.0	52.3	18.0	20.5	120	

PLAN 4 MIDNIGHT PLAN OPERATIVE TIMES	R1	2	↓	1	↶	4	←	3	↑	COORD PATTERN	OFFSET
	R2	5	↷	6	↑	8	→	7	↓	Balanced	8
		RING 1				RING 2					
	PHASE	1	2	3	4	5	6	7	8		
	SPLIT	12	51	12	15	12	51	12	15	Target Cycle Length	
	COORD		X				X			90	
	RECALLS		V				V			Actual Cycle Length	
	GREEN	6.0	45.3	6.0	9.5	6.0	45.3	6.0	9.5	90	

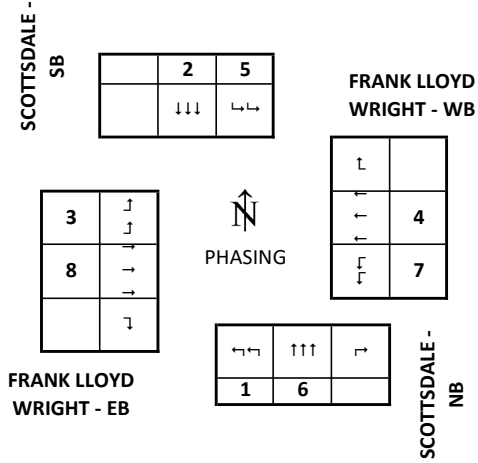
SCOTTSDALE & FRANK LLOYD WRIGHT			System # 162
BASIC TIMING PLAN	Section #	I.P. Address	Date Designed
		MM1-5-1 172.27.11.62	1/15/2021

Phase	1	2	3	4	5	6	7	8
Movement	NBL	SBT	EBL	WBT	SBL	NBT	WBL	EBT
NOTES	L-P	COORD	PROT		PROT	COORD	L-P	
MIN GRN	5	10	5	10	5	10	5	10
BK MGRN								
CS MGRN								
DLY GRN								
WALK		4		4		4		4
WALK2								
WLK MAX								
PED CLR/FDW		30		26		33		32
PD CLR2								
PC MAX								
PED CO								
VEH EXT	2	1	2	2	2	1	2	1
VH EXT2								
MAX 1	20	45	20	45	20	45	20	45
MAX 2	40	55	35	45	40	55	30	50
MAX 3								
DYM MAX								
DYM STP								
YELLOW	4	4.7	4	4.7	4	4.7	4.0	4.7
RED CLR	2	1.1	2	1.1	2	1.1	2	1.1
RED MAX								
RED RVT	2	2	2	2	2	2	2	2
ACT B4								
SEC/ACT								
MAX INT								
TIME B4								
CARS WT								
STPTDUC								
TTREDUC								
MIN GAP								
LOCK DET								
VEH RECALL		X		X		X		X
PED RECALL								
MAX RECALL								
SOFT RECALL								
NO REST								
ADD INIT CAL								

TIMING PLAN - MM-2-1

RECALLS - MM-2-8

NOTES	



PHASING SEQUENCES									
TOD: MORNING									
R1	<table border="1"><tr><td>1</td><td>2</td><td>4</td><td>3</td></tr><tr><td>6</td><td>5</td><td>7</td><td>8</td></tr></table>	1	2	4	3	6	5	7	8
1	2	4	3						
6	5	7	8						
R2	<table border="1"><tr><td>1</td><td>2</td><td>4</td><td>3</td></tr><tr><td>6</td><td>5</td><td>7</td><td>8</td></tr></table>	1	2	4	3	6	5	7	8
1	2	4	3						
6	5	7	8						
Use Timing plan:									
TOD: MIDDAY									
R1	<table border="1"><tr><td>1</td><td>2</td><td>4</td><td>3</td></tr><tr><td>6</td><td>5</td><td>7</td><td>8</td></tr></table>	1	2	4	3	6	5	7	8
1	2	4	3						
6	5	7	8						
R2	<table border="1"><tr><td>1</td><td>2</td><td>4</td><td>3</td></tr><tr><td>6</td><td>5</td><td>7</td><td>8</td></tr></table>	1	2	4	3	6	5	7	8
1	2	4	3						
6	5	7	8						
Use Timing plan:									
TOD: EVENING									
R1	<table border="1"><tr><td>1</td><td>2</td><td>4</td><td>3</td></tr><tr><td>6</td><td>5</td><td>7</td><td>8</td></tr></table>	1	2	4	3	6	5	7	8
1	2	4	3						
6	5	7	8						
R2	<table border="1"><tr><td>1</td><td>2</td><td>4</td><td>3</td></tr><tr><td>6</td><td>5</td><td>7</td><td>8</td></tr></table>	1	2	4	3	6	5	7	8
1	2	4	3						
6	5	7	8						
Use Timing plan:									
TOD: NIGHT									
R1	<table border="1"><tr><td>1</td><td>2</td><td>4</td><td>3</td></tr><tr><td>6</td><td>5</td><td>7</td><td>8</td></tr></table>	1	2	4	3	6	5	7	8
1	2	4	3						
6	5	7	8						
R2	<table border="1"><tr><td>1</td><td>2</td><td>4</td><td>3</td></tr><tr><td>6</td><td>5</td><td>7</td><td>8</td></tr></table>	1	2	4	3	6	5	7	8
1	2	4	3						
6	5	7	8						
Use Timing plan:									
FREE									
R1	<table border="1"><tr><td>1</td><td>2</td><td>4</td><td>3</td></tr><tr><td>6</td><td>5</td><td>7</td><td>8</td></tr></table>	1	2	4	3	6	5	7	8
1	2	4	3						
6	5	7	8						
R2	<table border="1"><tr><td>1</td><td>2</td><td>4</td><td>3</td></tr><tr><td>6</td><td>5</td><td>7</td><td>8</td></tr></table>	1	2	4	3	6	5	7	8
1	2	4	3						
6	5	7	8						
Use Timing plan: 254									

Approved By
Effective Date

SCOTTSDALE & FRANK LLOYD WRIGHT										System #		162	
COORDINATOR						Section #				Date Updated			
						0				1/15/2021			
	PHASE	1	2	3	4	5	6	7	8				
	FDW		30		26		33		32				
	YELLOW	4	4.7	4	4.7	4	4.7	4	4.7				
	ALL RED	2	1.1	2	1.1	2	1.1	2	1.1				
	WALK		30		26		33		32				
PLAN 1 AM PLAN OPERATIVE TIMES 6:00	R1	1	↶	2	↓	4	←	3	↑	COORD PATTERN	OFFSET		
	R2	6	↑	5	↷	7	↵	8	→	Balanced	67		
		RING 1				RING 2							
	PHASE	1	2	3	4	5	6	7	8				
	SPLIT	12	51	29	28	19	44	15	42	Target Cycle Length			
	COORD		X		X		X		X	120			
	RECALLS		V		V		V		V	Actual Cycle Length			
	GREEN	6.0	45.2	23.0	22.2	13.0	38.2	9.0	36.2	120			
PLAN 2 MIDDAY PLAN OPERATIVE TIMES 9:00	R1	1	↶	2	↓	4	←	3	↑	COORD PATTERN	OFFSET		
	R2	6	↑	5	↷	7	↵	8	→	Balanced	0		
		RING 1				RING 2							
	PHASE	1	2	3	4	5	6	7	8				
	SPLIT	16	47	18	27	25	38	20	25	Target Cycle Length			
	COORD		X		X		X		X	108			
	RECALLS		V		V		V		V	Actual Cycle Length			
	GREEN	10.0	41.2	###	21.2	###	32.2	14.0	19.2	108			
PLAN 3 PM PLAN OPERATIVE TIMES 15:00	R1	1	↶	2	↓	4	←	3	↑	COORD PATTERN	OFFSET		
	R2	6	↑	5	↷	7	↵	8	→	Balanced	114		
		RING 1				RING 2							
	PHASE	1	2	3	4	5	6	7	8				
	SPLIT	25	39	17	39	24	40	17	39	Target Cycle Length			
	COORD		X		X		X		X	120			
	RECALLS		V		V		V		V	Actual Cycle Length			
	GREEN	19.0	33.2	###	33.2	###	34.2	11.0	33.2	120			
PLAN 4 MIDNIGHT PLAN OPERATIVE TIMES	R1	1	↶	2	↓	4	←	3	↑	COORD PATTERN	OFFSET		
	R2	6	↑	5	↷	7	↵	8	→	Balanced	0		
		RING 1				RING 2							
	PHASE	1	2	3	4	5	6	7	8				
	SPLIT	15	35	15	25	21	29	15	25	Target Cycle Length			
	COORD		X		X		X			90			
	RECALLS		V		V		V			Actual Cycle Length			
	GREEN	9.0	29.2	9.0	19.2	###	23.2	9.0	19.2	90			

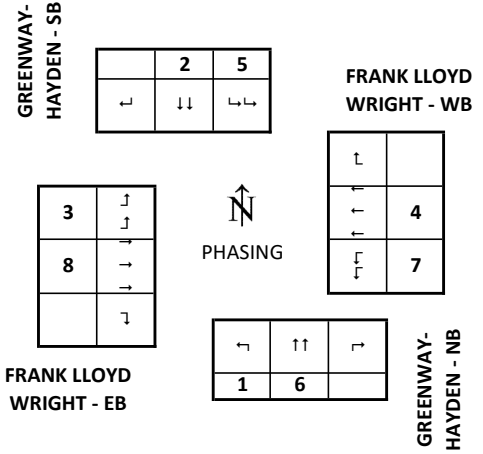
FRANK LLOYD WRIGHT & GREENWAY-HAYDEN			System # 208
BASIC TIMING PLAN	Section #	I.P. Address	Date Designed
		MM1-5-1 172.27.12.08	1/15/2021

Phase	1	2	3	4	5	6	7	8
Movement	NBL	SBT	EBL	WBT	SBL	NBT	WBL	EBT
NOTES	PROT		L-P	COORD	L-P		PROT	COORD
MIN GRN	5	7	5	10	5	7	5	10
BK MGRN								
CS MGRN			5				5	
DLY GRN								
WALK		7		7		7		7
WALK2								
WLK MAX								
PED CLR/FDW		33		23		31		26
PD CLR2								
PC MAX								
PED CO								
VEH EXT	2	1	1	1	2	1	1	1
VH EXT2								
MAX 1	25	50	30	60	20	45	30	60
MAX 2	50	55	45	65	45	50	45	65
MAX 3								
DYM MAX								
DYM STP								
YELLOW	3.6	4.4	4	4.7	3.6	4.4	4.0	4.7
RED CLR	2	1.2	2	1.0	2	1.2	2	1.0
RED MAX								
RED RVT	2	2	2	2	2	2	2	2
ACT B4								
SEC/ACT								
MAX INT								
TIME B4								
CARS WT								
STPTDUC								
TTREDUC								
MIN GAP								
LOCK DET								
VEH RECALL				X				X
PED RECALL								
MAX RECALL								
SOFT RECALL								
NO REST								
ADD INIT CAL								

TIMING PLAN - MM-2-1

RECALLS - MM-2-8

NOTES	



PHASING SEQUENCES									
TOD: MORNING									
R1	<table border="1"><tr><td>2</td><td>1</td><td>3</td><td>4</td></tr><tr><td>5</td><td>6</td><td>8</td><td>7</td></tr></table>	2	1	3	4	5	6	8	7
2	1	3	4						
5	6	8	7						
R2	<table border="1"><tr><td>2</td><td>1</td><td>3</td><td>4</td></tr><tr><td>5</td><td>6</td><td>8</td><td>7</td></tr></table>	2	1	3	4	5	6	8	7
2	1	3	4						
5	6	8	7						
Use Timing plan:									
TOD: MIDDAY									
R1	<table border="1"><tr><td>2</td><td>1</td><td>3</td><td>4</td></tr><tr><td>5</td><td>6</td><td>8</td><td>7</td></tr></table>	2	1	3	4	5	6	8	7
2	1	3	4						
5	6	8	7						
R2	<table border="1"><tr><td>2</td><td>1</td><td>3</td><td>4</td></tr><tr><td>5</td><td>6</td><td>8</td><td>7</td></tr></table>	2	1	3	4	5	6	8	7
2	1	3	4						
5	6	8	7						
Use Timing plan:									
TOD: EVENING									
R1	<table border="1"><tr><td>2</td><td>1</td><td>3</td><td>4</td></tr><tr><td>5</td><td>6</td><td>8</td><td>7</td></tr></table>	2	1	3	4	5	6	8	7
2	1	3	4						
5	6	8	7						
R2	<table border="1"><tr><td>2</td><td>1</td><td>3</td><td>4</td></tr><tr><td>5</td><td>6</td><td>8</td><td>7</td></tr></table>	2	1	3	4	5	6	8	7
2	1	3	4						
5	6	8	7						
Use Timing plan:									
TOD: NIGHT									
R1	<table border="1"><tr><td>2</td><td>1</td><td>3</td><td>4</td></tr><tr><td>5</td><td>6</td><td>8</td><td>7</td></tr></table>	2	1	3	4	5	6	8	7
2	1	3	4						
5	6	8	7						
R2	<table border="1"><tr><td>2</td><td>1</td><td>3</td><td>4</td></tr><tr><td>5</td><td>6</td><td>8</td><td>7</td></tr></table>	2	1	3	4	5	6	8	7
2	1	3	4						
5	6	8	7						
Use Timing plan:									
FREE									
R1	<table border="1"><tr><td>2</td><td>1</td><td>3</td><td>4</td></tr><tr><td>5</td><td>6</td><td>8</td><td>7</td></tr></table>	2	1	3	4	5	6	8	7
2	1	3	4						
5	6	8	7						
R2	<table border="1"><tr><td>2</td><td>1</td><td>3</td><td>4</td></tr><tr><td>5</td><td>6</td><td>8</td><td>7</td></tr></table>	2	1	3	4	5	6	8	7
2	1	3	4						
5	6	8	7						
Use Timing plan: 254									

Approved By
Effective Date

ANK LLOYD WRIGHT & GREENWAY-HAYD										System #		208	
COORDINATOR						Section #				Date Updated			
						0				1/15/2021			
	PHASE	1	2	3	4	5	6	7	8				
	FDW		33		23		31		26				
	YELLOW	3.6	4.4	4	4.7	3.6	4.4	4	4.7				
	ALL RED	2	1.2	2	1	2	1.2	2	1				
	WALK		33		23		31		26				
PLAN 1 AM PLAN OPERATIVE TIMES 6:00	R1	2	↓	1	↶	3	↑	4	↷	COORD PATTERN	OFFSET		
	R2	5	↵	6	↑	8	→	7	↴	Balanced	93		
		RING 1				RING 2							
	PHASE	1	2	3	4	5	6	7	8				
	SPLIT	16	22	30	52	12	26	28	54	Target Cycle Length			
	COORD				X				X	120			
	RECALLS				V				V	Actual Cycle Length			
	GREEN	10.4	16.4	24.0	46.3	6.4	20.4	22.0	48.3	120			
PLAN 2 MIDDAY PLAN OPERATIVE TIMES 9:00	R1	2	↓	1	↶	3	↑	4	↷	COORD PATTERN	OFFSET		
	R2	5	↵	6	↑	8	→	7	↴	Balanced	38		
		RING 1				RING 2							
	PHASE	1	2	3	4	5	6	7	8				
	SPLIT	17	21	23	47	12	26	20	50	Target Cycle Length			
	COORD				X				X	108			
	RECALLS				V				V	Actual Cycle Length			
	GREEN	11.4	15.4	###	41.3	6.4	20.4	14.0	44.3	108			
PLAN 3 PM PLAN OPERATIVE TIMES 15:00	R1	2	↓	1	↶	3	↑	4	↷	COORD PATTERN	OFFSET		
	R2	5	↵	6	↑	8	→	7	↴	Balanced	38		
		RING 1				RING 2							
	PHASE	1	2	3	4	5	6	7	8				
	SPLIT	15	29	25	50	14	30	21	55	Target Cycle Length			
	COORD				X				X	120			
	RECALLS				V				V	Actual Cycle Length			
	GREEN	9.4	23.4	###	44.3	8.4	24.4	15.0	49.3	120			
PLAN 4 MIDNIGHT PLAN OPERATIVE TIMES	R1	2	↓	1	↶	3	↑	4	↷	COORD PATTERN	OFFSET		
	R2	5	↵	6	↑	8	→	7	↴	Balanced	40		
		RING 1				RING 2							
	PHASE	1	2	3	4	5	6	7	8				
	SPLIT	13	23	23	31	11	25	16	38	Target Cycle Length			
	COORD				X				X	90			
	RECALLS				V				V	Actual Cycle Length			
	GREEN	7.4	17.4	###	25.3	5.4	19.4	10.0	32.3	90			

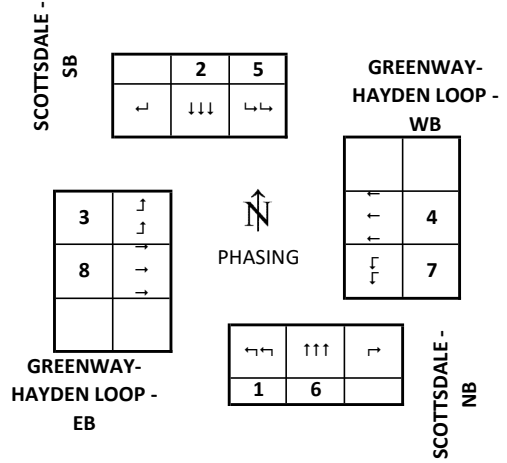
SCOTTSDALE & GREENWAY- HAYDEN LOOP			System # 211
BASIC TIMING PLAN	Section #	I.P. Address	Date Designed
		MM1-5-1 172.27.12.11	2/27/2019

Phase	1	2	3	4	5	6	7	8
Movement	NBL	SBT	EBL	WBT	SBL	NBT	WBL	EBT
NOTES	PROT	COORD	PROT		L-P	COORD	L-P	
MIN GRN	5	10	5	7	5	10	5	7
BK MGRN								
CS MGRN								
DLY GRN		4		4		4		4
WALK		4		4		4		4
WALK2		7		7		7		7
WLK MAX								
PED CLR/FDW		28		33		30		31
PD CLR2		28		33		30		31
PC MAX								
PED CO								
VEH EXT	2	2	2	2	2	2	2	2
VH EXT2								
MAX 1	15	65	15	50	15	65	15	50
MAX 2	30	75	30	60	30	75	30	60
MAX 3								
DYM MAX	30	75	30	60	30	75	30	60
DYM STP	5	5	5	5	5	5	5	5
YELLOW	4	4.7	3.3	4.4	4	4.7	3.6	4
RED CLR	2	1.0	2	1.3	2	1.0	2	1.6
RED MAX								
RED RVT	2	2	2	2	2	2	2	2
ACT B4								
SEC/ACT								
MAX INT								
TIME B4								
CARS WT								
STPTDUC								
TTREDUC								
MIN GAP								
LOCK DET								
VEH RECALL		X				X		
PED RECALL								
MAX RECALL								
SOFT RECALL								
NO REST								
ADD INIT CAL								

TIMING PLAN - MM-2-1

RECALLS - MM-2-8

NOTES	



PHASING SEQUENCES									
TOD: MORNING									
R1	<table border="1"><tr><td>2</td><td>1</td><td>4</td><td>3</td></tr><tr><td>6</td><td>5</td><td>7</td><td>8</td></tr></table>	2	1	4	3	6	5	7	8
2	1	4	3						
6	5	7	8						
R2	<table border="1"><tr><td>2</td><td>1</td><td>4</td><td>3</td></tr><tr><td>6</td><td>5</td><td>7</td><td>8</td></tr></table>	2	1	4	3	6	5	7	8
2	1	4	3						
6	5	7	8						
Use Timing plan:									
TOD: MIDDAY									
R1	<table border="1"><tr><td>2</td><td>1</td><td>4</td><td>3</td></tr><tr><td>6</td><td>5</td><td>7</td><td>8</td></tr></table>	2	1	4	3	6	5	7	8
2	1	4	3						
6	5	7	8						
R2	<table border="1"><tr><td>2</td><td>1</td><td>4</td><td>3</td></tr><tr><td>6</td><td>5</td><td>7</td><td>8</td></tr></table>	2	1	4	3	6	5	7	8
2	1	4	3						
6	5	7	8						
Use Timing plan:									
TOD: EVENING									
R1	<table border="1"><tr><td>2</td><td>1</td><td>4</td><td>3</td></tr><tr><td>6</td><td>5</td><td>7</td><td>8</td></tr></table>	2	1	4	3	6	5	7	8
2	1	4	3						
6	5	7	8						
R2	<table border="1"><tr><td>2</td><td>1</td><td>4</td><td>3</td></tr><tr><td>6</td><td>5</td><td>7</td><td>8</td></tr></table>	2	1	4	3	6	5	7	8
2	1	4	3						
6	5	7	8						
Use Timing plan:									
TOD: NIGHT									
R1	<table border="1"><tr><td>2</td><td>1</td><td>4</td><td>3</td></tr><tr><td>6</td><td>5</td><td>7</td><td>8</td></tr></table>	2	1	4	3	6	5	7	8
2	1	4	3						
6	5	7	8						
R2	<table border="1"><tr><td>2</td><td>1</td><td>4</td><td>3</td></tr><tr><td>6</td><td>5</td><td>7</td><td>8</td></tr></table>	2	1	4	3	6	5	7	8
2	1	4	3						
6	5	7	8						
Use Timing plan:									
FREE									
R1	<table border="1"><tr><td>2</td><td>1</td><td>4</td><td>3</td></tr><tr><td>5</td><td>6</td><td>7</td><td>8</td></tr></table>	2	1	4	3	5	6	7	8
2	1	4	3						
5	6	7	8						
R2	<table border="1"><tr><td>2</td><td>1</td><td>4</td><td>3</td></tr><tr><td>5</td><td>6</td><td>7</td><td>8</td></tr></table>	2	1	4	3	5	6	7	8
2	1	4	3						
5	6	7	8						
Use Timing plan: 254									

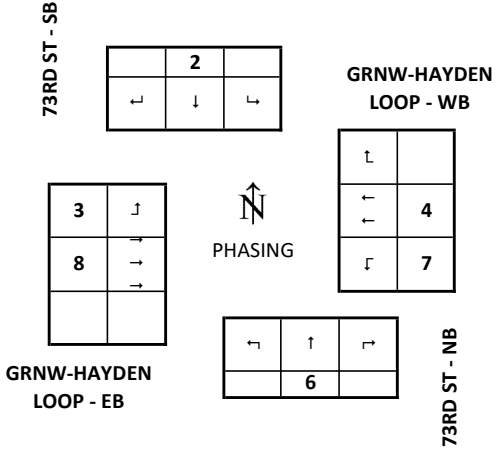
Approved By
Effective Date

COTTSDALE & GREENWAY- HAYDEN LOO										System #		211	
COORDINATOR						Section #				Date Updated			
						0				2/27/2019			
	PHASE	1	2	3	4	5	6	7	8				
	FDW		28		33		30		31				
	YELLOW	4	4.7	3.3	4.4	4	4.7	3.6	4				
	ALL RED	2	1	2	1.3	2	1	2	1.6				
	WALK		28		33		30		31				
PLAN 1 AM PLAN OPERATIVE TIMES 6:00	R1	2	↓	1	↶	4	←	3	↑	COORD PATTERN	OFFSET		
	R2	6	↑	5	↷	7	↵	8	→	Balanced	31		
		RING 1				RING 2							
	PHASE	1	2	3	4	5	6	7	8				
	SPLIT	12	54	16	38	12	54	17	37	Target Cycle Length			
	COORD		X				X			120			
	RECALLS		V				V			Actual Cycle Length			
	GREEN	6.0	48.3	10.7	32.3	6.0	48.3	11.4	31.4	120			
PLAN 2 MIDDAY PLAN OPERATIVE TIMES 9:00	R1	2	↓	1	↶	4	←	3	↑	COORD PATTERN	OFFSET		
	R2	6	↑	5	↷	7	↵	8	→	Balanced	104		
		RING 1				RING 2							
	PHASE	1	2	3	4	5	6	7	8				
	SPLIT	12	43	14	39	15	40	20	33	Target Cycle Length			
	COORD		X				X			108			
	RECALLS		V				V			Actual Cycle Length			
	GREEN	6.0	37.3	8.7	33.3	9.0	34.3	14.4	27.4	108			
PLAN 3 PM PLAN OPERATIVE TIMES 15:00	R1	2	↓	1	↶	4	←	3	↑	COORD PATTERN	OFFSET		
	R2	6	↑	5	↷	7	↵	8	→	Balanced	95		
		RING 1				RING 2							
	PHASE	1	2	3	4	5	6	7	8				
	SPLIT	14	47	20	39	18	43	22	37	Target Cycle Length			
	COORD		X				X			120			
	RECALLS		V				V			Actual Cycle Length			
	GREEN	8.0	41.3	###	33.3	###	37.3	16.4	31.4	120			
PLAN 4 MIDNIGHT PLAN OPERATIVE TIMES	R1	2	↓	1	↶	4	←	3	↑	COORD PATTERN	OFFSET		
	R2	6	↑	5	↷	7	↵	8	→	Balanced	0		
		RING 1				RING 2							
	PHASE	1	2	3	4	5	6	7	8				
	SPLIT	12	49	11	18	12	49	11	18	Target Cycle Length			
	COORD		X				X			90			
	RECALLS		V				V			Actual Cycle Length			
	GREEN	6.0	43.3	5.7	12.3	6.0	43.3	5.4	12.4	90			

GRNW-HAYDEN LOOP & 73RD ST			System # 212
BASIC TIMING PLAN	Section #	I.P. Address MM1-5-1	Date Designed
		172.27.12.12	5/26/2020

TIMING PLAN - MM-2-1	Phase		2	3	4		6	7	8	
	Movement		SBT	EBL	WBT		NBT	WBL	EBT	
	NOTES			p&P	COORD			p&P	COORD	
	MIN GRN		7	5	10		7	5	10	
	BK MGRN									
	CS MGRN									
	DLY GRN									
	WALK		4		4		4		4	
	WALK2									
	WLK MAX									
	PED CLR/FDW		26		16		25		15	
	PD CLR2									
	PC MAX									
	PED CO									
	VEH EXT		2	2	2	2	2	2	2	
	VH EXT2									
	MAX 1		15	65	15	50	15	65	15	50
	MAX 2		30	70	30	60	30	70	30	60
	MAX 3									
	DYM MAX		30	70	30	60	30	70	30	60
DYM STP		5	5	5	5	5	5	5	5	
YELLOW			3.6	3.6	4.4		3.6	3.6	4.4	
RED CLR			1.6	1.7	1.0		1.6	1.7	1.0	
RED MAX										
RED RVT			2	2	2		2	2	2	
ACT B4										
SEC/ACT										
MAX INT										
TIME B4										
CARS WT										
STPTDUC										
TTREDUC										
MIN GAP										
RECALLS - MM-2-8	LOCK DET									
	VEH RECALL		X			X				
	PED RECALL									
	MAX RECALL									
	SOFT RECALL									
	NO REST									
ADD INIT CAL										

NOTES



PHASING SEQUENCES			
TOD: MORNING			
R1	2	4	3
R2	6	8	7
	B	B	B
Use Timing plan:			
TOD: MIDDAY			
R1	2	4	3
R2	6	8	7
	B	B	B
Use Timing plan:			
TOD: EVENING			
R1	2	4	3
R2	6	8	7
	B	B	B
Use Timing plan:			
TOD: NIGHT			
R1	2	4	3
R2	6	8	7
	B	B	B
Use Timing plan:			
FREE			
R1	2	4	3
R2	6	8	7
	B	B	B
Use Timing plan: 254			

Approved By
Effective Date

GRNW-HAYDEN LOOP & 73RD ST										System #		212	
COORDINATOR					Section #					Date Updated			
					0					5/26/2020			
	PHASE	1	2	3	4	5	6	7	8				
	FDW		26		16		25		15				
	YELLOW		3.6	3.6	4.4		3.6	3.6	4.4				
	ALL RED		1.6	1.7	1		1.6	1.7	1				
	WALK		26		16		25		15				
PLAN 1 AM PLAN OPERATIVE TIMES 6:00	R1	2	↓			4	←	3	↑	COORD PATTERN	OFFSET		
	R2	6	↑			8	→	7	↓	Balanced	47		
		RING 1				RING 2							
	PHASE		2	3	4		6	7	8				
	SPLIT		27	12	81		27	12	81	Target Cycle Length			
	COORD				X				X	120			
	RECALLS				V				V	Actual Cycle Length			
	GREEN		21.8	6.7	75.6		21.8	6.7	75.6	120			
PLAN 2 MIDDAY PLAN OPERATIVE TIMES 9:00	R1	2	↓			4	←	3	↑	COORD PATTERN	OFFSET		
	R2	6	↑			8	→	7	↓	Balanced	5		
		RING 1				RING 2							
	PHASE		2	3	4		6	7	8				
	SPLIT		30	12	66		30	12	66	Target Cycle Length			
	COORD				X				X	108			
	RECALLS				V				V	Actual Cycle Length			
	GREEN		24.8	6.7	60.6		24.8	6.7	60.6	108			
PLAN 3 PM PLAN OPERATIVE TIMES 15:00	R1	2	↓			4	←	3	↑	COORD PATTERN	OFFSET		
	R2	6	↑			8	→	7	↓	Balanced	111		
		RING 1				RING 2							
	PHASE		2	3	4		6	7	8				
	SPLIT		25	14	81		25	14	81	Target Cycle Length			
	COORD				X				X	120			
	RECALLS				V				V	Actual Cycle Length			
	GREEN		19.8	8.7	75.6		19.8	8.7	75.6	120			
PLAN 4 MIDNIGHT PLAN OPERATIVE TIMES	R1	2	↓			4	←	3	↑	COORD PATTERN	OFFSET		
	R2	6	↑			8	→	7	↓	Balanced			
		RING 1				RING 2							
	PHASE		2	3	4		6	7	8				
	SPLIT									Target Cycle Length			
	COORD												
	RECALLS									Actual Cycle Length			
	GREEN									0			
PLAN 254 FREE PLAN OPERATIVE TIMES 22:00	R1	2	↓			4	←	3	↑	COORD PATTERN	OFFSET		
	R2	6	↑			8	→	7	↓	Balanced			
		RING 1				RING 2							
	PHASE		2	3	4		6	7	8				
	SPLIT									Target Cycle Length			
	COORD									XXX			
	RECALLS									Actual Cycle Length			
	GREEN		-5.2	-5.3	-5.4		-5.2	-5.3	-5.4	0			

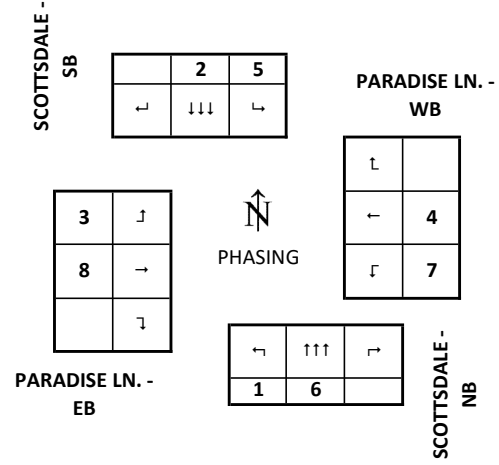
SCOTTSDALE & PARADISE LN.			System # 232
BASIC TIMING PLAN	Section #	I.P. Address MM1-5-1	Date Designed
		172.27.12.32	2/27/2019

Phase	1	2	3	4	5	6	7	8
Movement	NBL	SBT	EBL	WBT	SBL	NBT	WBL	EBT
NOTES	p&P	COORD	p&P		p&P	COORD	p&P	
MIN GRN	4	10	4	7	4	10	4	7
BK MGRN								
CS MGRN								
DLY GRN								
WALK		9		6		9		6
WALK2								
WLK MAX								
PED CLR/FDW		21		29		21		29
PD CLR2								
PC MAX								
PED CO								
VEH EXT	2		2	2	2		2	2
VH EXT2								
MAX 1	14	70	15	30	15	70	15	30
MAX 2	40	80	50	55	45	80	50	55
MAX 3								
DYM MAX								
DYM STP								
YELLOW	3	4.3	3	3.7	3	4.3	3.0	3.7
RED CLR	1	1.7	1	4.3	1	1.7	1	4.3
RED MAX								
RED RVT	2	2	2	2	2	2	2	2
ACT B4								
SEC/ACT								
MAX INT								
TIME B4								
CARS WT								
STPTDUC								
TTREDUC								
MIN GAP								
LOCK DET								
VEH RECALL		X				X		
PED RECALL								
MAX RECALL								
SOFT RECALL								
NO REST								
ADD INIT CAL								

TIMING PLAN - MM-2-1

RECALLS - MM-2-8

NOTES	



PHASING SEQUENCES									
TOD: MORNING									
R1	<table border="1"><tr><td>2</td><td>1</td><td>4</td><td>3</td></tr><tr><td>6</td><td>5</td><td>8</td><td>7</td></tr></table> B B B B	2	1	4	3	6	5	8	7
2	1	4	3						
6	5	8	7						
R2	<table border="1"><tr><td>2</td><td>1</td><td>4</td><td>3</td></tr><tr><td>6</td><td>5</td><td>8</td><td>7</td></tr></table> B B B B	2	1	4	3	6	5	8	7
2	1	4	3						
6	5	8	7						
Use Timing plan:									
TOD: MIDDAY									
R1	<table border="1"><tr><td>2</td><td>1</td><td>4</td><td>3</td></tr><tr><td>6</td><td>5</td><td>8</td><td>7</td></tr></table> B B B B	2	1	4	3	6	5	8	7
2	1	4	3						
6	5	8	7						
R2	<table border="1"><tr><td>2</td><td>1</td><td>4</td><td>3</td></tr><tr><td>6</td><td>5</td><td>8</td><td>7</td></tr></table> B B B B	2	1	4	3	6	5	8	7
2	1	4	3						
6	5	8	7						
Use Timing plan:									
TOD: EVENING									
R1	<table border="1"><tr><td>2</td><td>1</td><td>4</td><td>3</td></tr><tr><td>6</td><td>5</td><td>8</td><td>7</td></tr></table> B B B B	2	1	4	3	6	5	8	7
2	1	4	3						
6	5	8	7						
R2	<table border="1"><tr><td>2</td><td>1</td><td>4</td><td>3</td></tr><tr><td>6</td><td>5</td><td>8</td><td>7</td></tr></table> B B B B	2	1	4	3	6	5	8	7
2	1	4	3						
6	5	8	7						
Use Timing plan:									
TOD: NIGHT									
R1	<table border="1"><tr><td>2</td><td>1</td><td>4</td><td>3</td></tr><tr><td>6</td><td>5</td><td>8</td><td>7</td></tr></table> B B B B	2	1	4	3	6	5	8	7
2	1	4	3						
6	5	8	7						
R2	<table border="1"><tr><td>2</td><td>1</td><td>4</td><td>3</td></tr><tr><td>6</td><td>5</td><td>8</td><td>7</td></tr></table> B B B B	2	1	4	3	6	5	8	7
2	1	4	3						
6	5	8	7						
Use Timing plan:									
FREE									
R1	<table border="1"><tr><td>2</td><td>1</td><td>4</td><td>3</td></tr><tr><td>6</td><td>5</td><td>8</td><td>7</td></tr></table> B B B B	2	1	4	3	6	5	8	7
2	1	4	3						
6	5	8	7						
R2	<table border="1"><tr><td>2</td><td>1</td><td>4</td><td>3</td></tr><tr><td>6</td><td>5</td><td>8</td><td>7</td></tr></table> B B B B	2	1	4	3	6	5	8	7
2	1	4	3						
6	5	8	7						
Use Timing plan: 254									

Approved By
Effective Date

SCOTTSDALE & PARADISE LN.

System #

232

COORDINATOR

Section #

0

Date Updated

2/27/2019

PHASE	1	2	3	4	5	6	7	8
FDW		21		29		21		29
YELLOW	3	4.3	3	3.7	3	4.3	3	3.7
ALL RED	1	1.7	1	4.3	1	1.7	1	4.3
WALK		21		29		21		29

PLAN 1 AM PLAN OPERATIVE TIMES 6:00	R1	2	↓	1	↶	4	←	3	↑	COORD PATTERN	OFFSET
	R2	6	↑	5	↷	8	→	7	↓	Balanced	20
		RING 1				RING 2					
	PHASE	1	2	3	4	5	6	7	8		
	SPLIT	13	71	11	25	13	71	11	25	Target Cycle Length	
	COORD		X				X			120	
	RECALLS		P				P			Actual Cycle Length	
	GREEN	9.0	65.0	7.0	17.0	9.0	65.0	7.0	17.0	120	

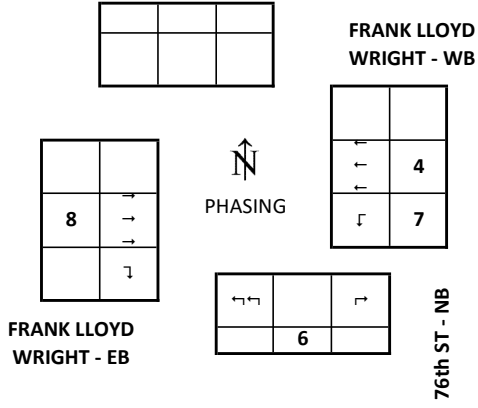
PLAN 2 MIDDAY PLAN OPERATIVE TIMES 9:00	R1	2	↓	1	↶	4	←	3	↑	COORD PATTERN	OFFSET
	R2	6	↑	5	↷	8	→	7	↓	Balanced	48
		RING 1				RING 2					
	PHASE	1	2	3	4	5	6	7	8		
	SPLIT	12	60	16	20	12	60	16	20	Target Cycle Length	
	COORD		X				X			108	
	RECALLS		P				P			Actual Cycle Length	
	GREEN	8.0	54.1	###	12.0	8.0	54.1	12.0	12.0	108	

PLAN 3 PM PLAN OPERATIVE TIMES 15:00	R1	2	↓	1	↶	4	←	3	↑	COORD PATTERN	OFFSET
	R2	6	↑	5	↷	8	→	7	↓	Balanced	49
		RING 1				RING 2					
	PHASE	1	2	3	4	5	6	7	8		
	SPLIT	11	65	18	26	11	65	18	26	Target Cycle Length	
	COORD		X				X			120	
	RECALLS		P				P			Actual Cycle Length	
	GREEN	7.0	59.1	###	18.0	7.0	59.1	14.0	18.0	120	

PLAN 4 MIDNIGHT PLAN OPERATIVE TIMES	R1	2	↓	1	↶	4	←	3	↑	COORD PATTERN	OFFSET
	R2	6	↑	5	↷	8	→	7	↓	Balanced	48
		RING 1				RING 2					
	PHASE	1	2	3	4	5	6	7	8		
	SPLIT	11	49	19	11	11	49	19	11	Target Cycle Length	
	COORD		X				X			90	
	RECALLS		P				P			Actual Cycle Length	
	GREEN	7.0	43.1	###	3.0	7.0	43.1	15.0	3.0	90	

FRANK LLOYD WRIGHT & 76th ST			System # 249
BASIC TIMING PLAN	Section #	I.P. Address MM1-5-1	Date Designed
		172.27.12.49	1/15/2021

TIMING PLAN - MM-2-1	Phase			4		6	7	8
	Movement			WBT		NBT	WBL	EBT
	NOTES			COORD			L-P&p	COORD
	MIN GRN			10		7	5	10
	BK MGRN							
	CS MGRN							
	DLY GRN							
	WALK			0		9		7
	WALK2							
	WLK MAX							
	PED CLR/FDW			-		30		15
	PD CLR2							
	PC MAX							
	PED CO							
	VEH EXT					2		
	VH EXT2							
	MAX 1			70		50	20	50
	MAX 2			105		60	25	105
	MAX 3							
	DYM MAX							
DYM STP								
YELLOW			4.7		3	4.0	4.7	
RED CLR			1.5		2.0	1.9	1.5	
RED MAX								
RED RVT			2		2	2	2	
ACT B4								
SEC/ACT								
MAX INT								
TIME B4								
CARS WT								
STPTDUC								
TTREDUC								
MIN GAP								
RECALLS - MM-2-8	LOCK DET							
	VEH RECALL			X				X
	PED RECALL							
	MAX RECALL							
	SOFT RECALL							
NO REST								
ADD INIT CAL								



PHASING SEQUENCES									
TOD: MORNING									
R1	<table border="1"><tr><td></td><td></td><td>4</td><td></td></tr><tr><td>6</td><td></td><td>7</td><td>8</td></tr></table>			4		6		7	8
		4							
6		7	8						
R2	<table border="1"><tr><td></td><td></td><td></td><td></td></tr><tr><td></td><td></td><td></td><td></td></tr></table>								
Use Timing plan:									
TOD: MIDDAY									
R1	<table border="1"><tr><td></td><td></td><td>4</td><td></td></tr><tr><td>6</td><td></td><td>7</td><td>8</td></tr></table>			4		6		7	8
		4							
6		7	8						
R2	<table border="1"><tr><td></td><td></td><td></td><td></td></tr><tr><td></td><td></td><td></td><td></td></tr></table>								
Use Timing plan:									
TOD: EVENING									
R1	<table border="1"><tr><td></td><td></td><td>4</td><td></td></tr><tr><td>6</td><td></td><td>7</td><td>8</td></tr></table>			4		6		7	8
		4							
6		7	8						
R2	<table border="1"><tr><td></td><td></td><td></td><td></td></tr><tr><td></td><td></td><td></td><td></td></tr></table>								
Use Timing plan:									
TOD: NIGHT									
R1	<table border="1"><tr><td></td><td></td><td>4</td><td></td></tr><tr><td>6</td><td></td><td>7</td><td>8</td></tr></table>			4		6		7	8
		4							
6		7	8						
R2	<table border="1"><tr><td></td><td></td><td></td><td></td></tr><tr><td></td><td></td><td></td><td></td></tr></table>								
Use Timing plan:									
FREE									
R1	<table border="1"><tr><td></td><td></td><td>4</td><td></td></tr><tr><td>6</td><td></td><td>7</td><td>8</td></tr></table>			4		6		7	8
		4							
6		7	8						
R2	<table border="1"><tr><td></td><td></td><td></td><td></td></tr><tr><td></td><td></td><td></td><td></td></tr></table>								
Use Timing plan: 254									

NOTES

Approved By
Effective Date

FRANK LLOYD WRIGHT & 76th ST										System #		249	
COORDINATOR						Section #				Date Updated			
						0				1/15/2021			
	PHASE	1	2	3	4	5	6	7	8				
	FDW				-		30		15				
	YELLOW				4.7		3	4	4.7				
	ALL RED				1.5		2	1.9	1.5				
	WALK				-		30		15				
PLAN 1 AM PLAN OPERATIVE TIMES 6:00	R1					4	←			COORD PATTERN	OFFSET		
	R2	6	↑			7	↙	8	→	Balanced	75		
		RING 1				RING 2							
	PHASE				4		6	7	8				
	SPLIT				97		23	20	77	Target Cycle Length			
	COORD				X				X	120			
	RECALLS				V				V	Actual Cycle Length			
	GREEN				90.8		18.0	14.1	70.8	120			
PLAN 2 MIDDAY PLAN OPERATIVE TIMES 9:00	R1					4	←			COORD PATTERN	OFFSET		
	R2	6	↑			7	↙	8	→	Balanced	15		
		RING 1				RING 2							
	PHASE				4		6	7	8				
	SPLIT				80		28	20	60	Target Cycle Length			
	COORD				X				X	108			
	RECALLS				V				V	Actual Cycle Length			
	GREEN				73.8		23.0	14.1	53.8	108			
PLAN 3 PM PLAN OPERATIVE TIMES 15:00	R1					4	←			COORD PATTERN	OFFSET		
	R2	6	↑			7	↙	8	→	Balanced	1144		
		RING 1				RING 2							
	PHASE				4		6	7	8				
	SPLIT				95		25	15	80	Target Cycle Length			
	COORD				X				X	120			
	RECALLS				V				V	Actual Cycle Length			
	GREEN				88.8		20.0	9.1	73.8	120			
PLAN 4 MIDNIGHT PLAN OPERATIVE TIMES	R1					4	←			COORD PATTERN	OFFSET		
	R2	6	↑			7	↙	8	→	Balanced	48		
		RING 1				RING 2							
	PHASE				4		6	7	8				
	SPLIT				62		28	11	51	Target Cycle Length			
	COORD				X				X	90			
	RECALLS				V				V	Actual Cycle Length			
	GREEN				55.8		23.0	5.1	44.8	90			



Appendix F – Existing Capacity Analysis

1: Scottsdale Road & Bell Road/Frank Lloyd Wright Boulevard

08/18/2022



Movement	EBL	EBT	EBR	WBL	WBT	WBR	NBL	NBT	NBR	SBL	SBT	SBR
Lane Configurations	↔↔	↑↑↑	↔	↔↔	↑↑↑	↔	↔↔	↑↑↑	↔	↔↔	↑↑↑	↔
Traffic Volume (veh/h)	345	996	270	149	397	182	111	562	94	327	1266	152
Future Volume (veh/h)	345	996	270	149	397	182	111	562	94	327	1266	152
Initial Q (Qb), veh	0	0	0	0	0	0	0	0	0	0	0	0
Ped-Bike Adj(A_pbT)	1.00		1.00	1.00		1.00	1.00		1.00	1.00		1.00
Parking Bus, Adj	1.00	1.00	1.00	1.00	1.00	1.00	1.00	1.00	1.00	1.00	1.00	1.00
Work Zone On Approach		No			No			No			No	
Adj Sat Flow, veh/h/ln	1870	1870	1870	1870	1870	1870	1870	1870	1870	1870	1870	1870
Adj Flow Rate, veh/h	392	1132	307	169	451	207	126	639	107	372	1439	173
Peak Hour Factor	0.88	0.88	0.88	0.88	0.88	0.88	0.88	0.88	0.88	0.88	0.88	0.88
Percent Heavy Veh, %	2	2	2	2	2	2	2	2	2	2	2	2
Cap, veh/h	697	1273	395	221	579	712	173	780	242	1160	2017	242
Arrive On Green	0.20	0.25	0.25	0.13	0.23	0.23	0.02	0.05	0.05	0.34	0.44	0.44
Sat Flow, veh/h	3456	5106	1585	3456	5106	1585	3456	5106	1585	3456	4619	555
Grp Volume(v), veh/h	392	1132	307	169	451	207	126	639	107	372	1060	552
Grp Sat Flow(s),veh/h/ln	1728	1702	1585	1728	1702	1585	1728	1702	1585	1728	1702	1770
Q Serve(g_s), s	12.3	25.7	21.6	5.7	10.0	0.0	4.4	14.9	6.4	9.6	30.6	30.6
Cycle Q Clear(g_c), s	12.3	25.7	21.6	5.7	10.0	0.0	4.4	14.9	6.4	9.6	30.6	30.6
Prop In Lane	1.00		1.00	1.00		1.00	1.00		1.00	1.00		0.31
Lane Grp Cap(c), veh/h	697	1273	395	221	579	712	173	780	242	1160	1486	773
V/C Ratio(X)	0.56	0.89	0.78	0.76	0.78	0.29	0.73	0.82	0.44	0.32	0.71	0.71
Avail Cap(c_a), veh/h	697	1540	478	259	945	825	173	1625	505	1160	1486	773
HCM Platoon Ratio	1.00	1.00	1.00	2.00	2.00	2.00	0.33	0.33	0.33	1.00	1.00	1.00
Upstream Filter(I)	1.00	1.00	1.00	0.99	0.99	0.99	0.85	0.85	0.85	1.00	1.00	1.00
Uniform Delay (d), s/veh	43.1	43.4	41.9	51.4	45.0	17.9	58.2	55.3	34.0	29.7	27.7	27.7
Incr Delay (d2), s/veh	0.6	5.2	5.1	8.7	0.9	0.1	11.0	8.1	4.9	0.1	2.9	5.6
Initial Q Delay(d3),s/veh	0.0	0.0	0.0	0.0	0.0	0.0	0.0	0.0	0.0	0.0	0.0	0.0
%ile BackOfQ(50%),veh/ln	5.2	11.0	8.7	2.5	3.7	3.0	2.2	7.4	3.5	3.9	12.3	13.4
Unsig. Movement Delay, s/veh												
LnGrp Delay(d),s/veh	43.8	48.7	47.1	60.1	45.8	18.0	69.2	63.4	38.9	29.7	30.6	33.2
LnGrp LOS	D	D	D	E	D	B	E	E	D	C	C	C
Approach Vol, veh/h		1831			827			872			1984	
Approach Delay, s/veh		47.4			41.8			61.3			31.2	
Approach LOS		D			D			E			C	
Timer - Assigned Phs	1	2	3	4	5	6	7	8				
Phs Duration (G+Y+Rc), s	12.0	58.4	30.2	19.4	46.3	24.1	13.7	35.9				
Change Period (Y+Rc), s	6.0	* 6	* 6	5.8	* 6	5.8	6.0	* 6				
Max Green Setting (Gmax), s	6.0	* 45	* 23	22.2	* 13	38.2	9.0	* 36				
Max Q Clear Time (g_c+I1), s	6.4	32.6	14.3	12.0	11.6	16.9	7.7	27.7				
Green Ext Time (p_c), s	0.0	3.3	0.5	1.7	0.1	1.4	0.0	2.3				

Intersection Summary

HCM 6th Ctrl Delay	42.9
HCM 6th LOS	D

Notes

- User approved pedestrian interval to be less than phase max green.
- * HCM 6th computational engine requires equal clearance times for the phases crossing the barrier.

2: Scottsdale Road & Paradise Lane

08/18/2022

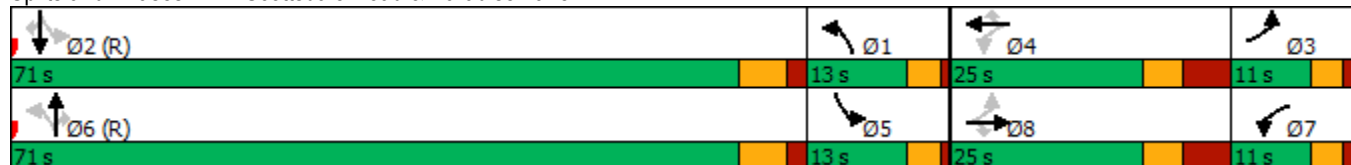


Lane Group	EBL	EBT	EBR	WBL	WBT	WBR	NBL	NBT	NBR	SBL	SBT	SBR
Lane Configurations												
Traffic Volume (vph)	38	12	6	45	19	56	26	671	49	130	1287	44
Future Volume (vph)	38	12	6	45	19	56	26	671	49	130	1287	44
Turn Type	pm+pt	NA	Perm	pm+pt	NA	Perm	pm+pt	NA	Perm	pm+pt	NA	Perm
Protected Phases	3	8		7	4		1	6		5	2	
Permitted Phases	8		8	4		4	6		6	2		2
Detector Phase	3	8	8	7	4	4	1	6	6	5	2	2
Switch Phase												
Minimum Initial (s)	4.0	7.0	7.0	4.0	7.0	7.0	4.0	10.0	10.0	4.0	10.0	10.0
Minimum Split (s)	10.0	15.0	15.0	11.0	15.0	15.0	11.0	16.0	16.0	11.0	16.0	16.0
Total Split (s)	11.0	25.0	25.0	11.0	25.0	25.0	13.0	71.0	71.0	13.0	71.0	71.0
Total Split (%)	9.2%	20.8%	20.8%	9.2%	20.8%	20.8%	10.8%	59.2%	59.2%	10.8%	59.2%	59.2%
Yellow Time (s)	3.0	3.7	3.7	3.0	3.7	3.7	3.0	4.3	4.3	3.0	4.3	4.3
All-Red Time (s)	1.0	4.3	4.3	1.0	4.3	4.3	1.0	1.7	1.7	1.0	1.7	1.7
Lost Time Adjust (s)	0.0	0.0	0.0	0.0	0.0	0.0	0.0	0.0	0.0	0.0	0.0	0.0
Total Lost Time (s)	4.0	8.0	8.0	4.0	8.0	8.0	4.0	6.0	6.0	4.0	6.0	6.0
Lead/Lag	Lag	Lead	Lead	Lag	Lead	Lead	Lag	Lead	Lead	Lag	Lead	Lead
Lead-Lag Optimize?	Yes	Yes	Yes	Yes	Yes	Yes	Yes	Yes	Yes	Yes	Yes	Yes
Recall Mode	None	None	None	Min	None	None	Max	C-Min	C-Min	None	C-Min	C-Min
Act Effct Green (s)	9.8	7.0	7.0	17.4	7.2	7.2	72.7	32.4	32.4	93.1	48.8	48.8
Actuated g/C Ratio	0.08	0.06	0.06	0.14	0.06	0.06	0.61	0.27	0.27	0.78	0.41	0.41
v/c Ratio	0.28	0.12	0.04	0.21	0.19	0.33	0.05	0.54	0.11	0.15	0.69	0.07
Control Delay	51.5	56.2	0.3	45.3	57.7	7.6	5.4	33.5	6.0	14.9	23.6	1.0
Queue Delay	0.0	0.0	0.0	0.0	0.0	0.0	0.0	0.0	0.0	0.0	0.0	0.0
Total Delay	51.5	56.2	0.3	45.3	57.7	7.6	5.4	33.5	6.0	14.9	23.6	1.0
LOS	D	E	A	D	E	A	A	C	A	B	C	A
Approach Delay		46.7			29.7			30.7			22.2	
Approach LOS		D			C			C			C	

Intersection Summary

Cycle Length: 120
 Actuated Cycle Length: 120
 Offset: 20 (17%), Referenced to phase 2:SBTL and 6:NBTL, Start of 1st Green
 Natural Cycle: 60
 Control Type: Actuated-Coordinated
 Maximum v/c Ratio: 0.69
 Intersection Signal Delay: 25.8
 Intersection Capacity Utilization 52.4%
 Analysis Period (min) 15
 Intersection LOS: C
 ICU Level of Service A

Splits and Phases: 2: Scottsdale Road & Paradise Lane



2: Scottsdale Road & Paradise Lane

08/18/2022



Movement	EBL	EBT	EBR	WBL	WBT	WBR	NBL	NBT	NBR	SBL	SBT	SBR
Lane Configurations	↘	↑	↗	↘	↑	↗	↘	↑↑↑	↗	↘	↑↑↑	↗
Traffic Volume (veh/h)	38	12	6	45	19	56	26	671	49	130	1287	44
Future Volume (veh/h)	38	12	6	45	19	56	26	671	49	130	1287	44
Initial Q (Qb), veh	0	0	0	0	0	0	0	0	0	0	0	0
Ped-Bike Adj(A_pbT)	1.00		1.00	1.00		1.00	1.00		1.00	1.00		1.00
Parking Bus, Adj	1.00	1.00	1.00	1.00	1.00	1.00	1.00	1.00	1.00	1.00	1.00	1.00
Work Zone On Approach		No			No			No			No	
Adj Sat Flow, veh/h/ln	1870	1870	1870	1870	1870	1870	1870	1870	1870	1870	1870	1870
Adj Flow Rate, veh/h	42	13	7	50	21	62	29	746	54	144	1430	49
Peak Hour Factor	0.90	0.90	0.90	0.90	0.90	0.90	0.90	0.90	0.90	0.90	0.90	0.90
Percent Heavy Veh, %	2	2	2	2	2	2	2	2	2	2	2	2
Cap, veh/h	181	108	92	191	108	92	802	862	267	1057	1578	490
Arrive On Green	0.03	0.06	0.06	0.03	0.06	0.06	0.14	0.06	0.06	0.18	0.10	0.10
Sat Flow, veh/h	1781	1870	1585	1781	1870	1585	1781	5106	1585	1781	5106	1585
Grp Volume(v), veh/h	42	13	7	50	21	62	29	746	54	144	1430	49
Grp Sat Flow(s),veh/h/ln	1781	1870	1585	1781	1870	1585	1781	1702	1585	1781	1702	1585
Q Serve(g_s), s	0.0	0.8	0.5	0.0	1.3	4.6	0.0	17.4	3.9	3.6	33.3	3.4
Cycle Q Clear(g_c), s	0.0	0.8	0.5	0.0	1.3	4.6	0.0	17.4	3.9	3.6	33.3	3.4
Prop In Lane	1.00		1.00	1.00		1.00	1.00		1.00	1.00		1.00
Lane Grp Cap(c), veh/h	181	108	92	191	108	92	802	862	267	1057	1578	490
V/C Ratio(X)	0.23	0.12	0.08	0.26	0.19	0.67	0.04	0.87	0.20	0.14	0.91	0.10
Avail Cap(c_a), veh/h	226	265	225	235	265	225	802	2766	859	1057	2766	859
HCM Platoon Ratio	1.00	1.00	1.00	1.00	1.00	1.00	0.33	0.33	0.33	0.33	0.33	0.33
Upstream Filter(I)	1.00	1.00	1.00	1.00	1.00	1.00	1.00	1.00	1.00	0.58	0.58	0.58
Uniform Delay (d), s/veh	52.4	53.6	53.5	52.1	53.8	55.4	30.2	55.3	48.9	22.4	52.2	38.7
Incr Delay (d2), s/veh	0.2	0.2	0.1	0.3	0.3	3.2	0.1	11.4	1.7	0.0	5.6	0.2
Initial Q Delay(d3),s/veh	0.0	0.0	0.0	0.0	0.0	0.0	0.0	0.0	0.0	0.0	0.0	0.0
%ile BackOfQ(50%),veh/ln	1.2	0.4	0.2	1.4	0.6	1.9	0.7	8.8	1.7	3.1	15.9	1.4
Unsig. Movement Delay, s/veh												
LnGrp Delay(d),s/veh	52.7	53.8	53.6	52.4	54.2	58.6	30.3	66.7	50.6	22.4	57.8	39.0
LnGrp LOS	D	D	D	D	D	E	C	E	D	C	E	D
Approach Vol, veh/h		62			133			829			1623	
Approach Delay, s/veh		53.0			55.6			64.3			54.1	
Approach LOS		D			E			E			D	
Timer - Assigned Phs	1	2	3	4	5	6	7	8				
Phs Duration (G+Y+Rc), s	54.0	43.1	8.0	15.0	70.8	26.2	8.0	14.9				
Change Period (Y+Rc), s	* 4	6.0	* 4	8.0	* 4	6.0	* 4	8.0				
Max Green Setting (Gmax), s	* 9	65.0	* 7	17.0	* 9	65.0	* 7	17.0				
Max Q Clear Time (g_c+I1), s	2.0	35.3	2.0	6.6	5.6	19.4	2.0	2.8				
Green Ext Time (p_c), s	0.0	1.8	0.0	0.1	0.1	0.9	0.0	0.0				

Intersection Summary

HCM 6th Ctrl Delay	57.3
HCM 6th LOS	E

Notes

- User approved pedestrian interval to be less than phase max green.
- * HCM 6th computational engine requires equal clearance times for the phases crossing the barrier.

3: Scottsdale Road & Driveway A

08/18/2022

Intersection						
Int Delay, s/veh	0					
Movement	EBL	EBR	NBL	NBT	SBT	SBR
Lane Configurations		↗	↘	↑↑↑	↑↑↑	↗
Traffic Vol, veh/h	0	2	6	745	1339	3
Future Vol, veh/h	0	2	6	745	1339	3
Conflicting Peds, #/hr	0	0	0	0	0	0
Sign Control	Stop	Stop	Free	Free	Free	Free
RT Channelized	-	None	-	None	-	None
Storage Length	-	0	110	-	-	110
Veh in Median Storage, #	0	-	-	0	0	-
Grade, %	0	-	-	0	0	-
Peak Hour Factor	92	92	92	92	92	92
Heavy Vehicles, %	2	2	2	2	2	2
Mvmt Flow	0	2	7	810	1455	3
Major/Minor	Minor2	Major1		Major2		
Conflicting Flow All	-	728	1458	0	-	0
Stage 1	-	-	-	-	-	-
Stage 2	-	-	-	-	-	-
Critical Hdwy	-	7.14	5.34	-	-	-
Critical Hdwy Stg 1	-	-	-	-	-	-
Critical Hdwy Stg 2	-	-	-	-	-	-
Follow-up Hdwy	-	3.92	3.12	-	-	-
Pot Cap-1 Maneuver	0	*610	*767	-	-	-
Stage 1	0	-	-	-	-	-
Stage 2	0	-	-	-	-	-
Platoon blocked, %		1	1	-	-	-
Mov Cap-1 Maneuver	-	*610	*767	-	-	-
Mov Cap-2 Maneuver	-	-	-	-	-	-
Stage 1	-	-	-	-	-	-
Stage 2	-	-	-	-	-	-
Approach	EB	NB		SB		
HCM Control Delay, s	10.9	0.1		0		
HCM LOS	B					
Minor Lane/Major Mvmt	NBL	NBT	EBLn1	SBT	SBR	
Capacity (veh/h)	* 767	-	610	-	-	
HCM Lane V/C Ratio	0.009	-	0.004	-	-	
HCM Control Delay (s)	9.7	-	10.9	-	-	
HCM Lane LOS	A	-	B	-	-	
HCM 95th %tile Q(veh)	0	-	0	-	-	
Notes						
~: Volume exceeds capacity \$: Delay exceeds 300s +: Computation Not Defined *: All major volume in platoon						

Intersection												
Int Delay, s/veh	1.1											
Movement	EBL	EBT	EBR	WBL	WBT	WBR	NBL	NBT	NBR	SBL	SBT	SBR
Lane Configurations	↖	↗		↖	↗	↖	↖	↖↖↖	↖	↖	↖↖↖	↖
Traffic Vol, veh/h	10	3	14	12	1	66	12	680	39	70	1249	16
Future Vol, veh/h	10	3	14	12	1	66	12	680	39	70	1249	16
Conflicting Peds, #/hr	0	0	0	0	0	0	0	0	0	0	0	0
Sign Control	Stop	Stop	Stop	Stop	Stop	Stop	Free	Free	Free	Free	Free	Free
RT Channelized	-	-	None	-	-	None	-	-	None	-	-	None
Storage Length	100	-	-	80	-	115	200	-	205	195	-	100
Veh in Median Storage, #	-	0	-	-	0	-	-	0	-	-	0	-
Grade, %	-	0	-	-	0	-	-	0	-	-	0	-
Peak Hour Factor	92	92	92	92	92	92	92	92	92	92	92	92
Heavy Vehicles, %	2	2	2	2	2	2	2	2	2	2	2	2
Mvmt Flow	11	3	15	13	1	72	13	739	42	76	1358	17

Major/Minor	Minor2		Minor1		Major1			Major2				
Conflicting Flow All	1832	2317	679	1462	2292	370	1375	0	0	781	0	0
Stage 1	1510	1510	-	765	765	-	-	-	-	-	-	-
Stage 2	322	807	-	697	1527	-	-	-	-	-	-	-
Critical Hdwy	6.44	6.54	7.14	6.44	6.54	7.14	5.34	-	-	5.34	-	-
Critical Hdwy Stg 1	7.34	5.54	-	7.34	5.54	-	-	-	-	-	-	-
Critical Hdwy Stg 2	6.74	5.54	-	6.74	5.54	-	-	-	-	-	-	-
Follow-up Hdwy	3.82	4.02	3.92	3.82	4.02	3.92	3.12	-	-	3.12	-	-
Pot Cap-1 Maneuver	*211	81	*632	*407	85	*761	*794	-	-	937	-	-
Stage 1	*510	527	-	*781	742	-	-	-	-	-	-	-
Stage 2	*781	706	-	*648	514	-	-	-	-	-	-	-
Platoon blocked, %	1	1	1	1	1	1	1	-	-	1	-	-
Mov Cap-1 Maneuver	*175	74	*632	*355	77	*761	*794	-	-	937	-	-
Mov Cap-2 Maneuver	*175	74	-	*355	77	-	-	-	-	-	-	-
Stage 1	*502	484	-	*768	730	-	-	-	-	-	-	-
Stage 2	*695	695	-	*577	472	-	-	-	-	-	-	-

Approach	EB		WB		NB		SB	
HCM Control Delay, s	22.1		11.5		0.2		0.5	
HCM LOS	C		B					

Minor Lane/Major Mvmt	NBL	NBT	NBR	EBLn1	EBLn2	WBLn1	WBLn2	WBLn3	SBL	SBT	SBR
Capacity (veh/h)	*794	-	-	175	271	355	77	761	937	-	-
HCM Lane V/C Ratio	0.016	-	-	0.062	0.068	0.037	0.014	0.094	0.081	-	-
HCM Control Delay (s)	9.6	-	-	26.9	19.3	15.5	52.4	10.2	9.2	-	-
HCM Lane LOS	A	-	-	D	C	C	F	B	A	-	-
HCM 95th %tile Q(veh)	0.1	-	-	0.2	0.2	0.1	0	0.3	0.3	-	-

Notes
 ~: Volume exceeds capacity \$: Delay exceeds 300s +: Computation Not Defined *: All major volume in platoon

5: Scottsdale Road & Kierland Boulevard/Greenway Hayden Loop

08/18/2022



Movement	EBL	EBT	EBR	WBL	WBT	WBR	NBL	NBT	NBR	SBL	SBT	SBR
Lane Configurations	↔↔	↑↑	↔	↔↔	↑↑↔		↔↔	↑↑↑	↔	↔↔	↑↑↑	↔
Traffic Volume (veh/h)	41	119	36	219	157	42	36	664	346	131	989	133
Future Volume (veh/h)	41	119	36	219	157	42	36	664	346	131	989	133
Initial Q (Qb), veh	0	0	0	0	0	0	0	0	0	0	0	0
Ped-Bike Adj(A_pbT)	1.00		1.00	1.00		1.00	1.00		1.00	1.00		1.00
Parking Bus, Adj	1.00	1.00	1.00	1.00	1.00	1.00	1.00	1.00	1.00	1.00	1.00	1.00
Work Zone On Approach		No			No			No			No	
Adj Sat Flow, veh/h/ln	1870	1870	1870	1870	1870	1870	1870	1870	1870	1870	1870	1870
Adj Flow Rate, veh/h	46	132	40	243	174	47	40	738	384	146	1099	148
Peak Hour Factor	0.90	0.90	0.90	0.90	0.90	0.90	0.90	0.90	0.90	0.90	0.90	0.90
Percent Heavy Veh, %	2	2	2	2	2	2	2	2	2	2	2	2
Cap, veh/h	263	207	92	301	278	71	1432	1083	336	1561	1274	396
Arrive On Green	0.08	0.06	0.06	0.03	0.02	0.02	0.83	0.42	0.42	0.90	0.50	0.50
Sat Flow, veh/h	3456	3554	1585	3456	4058	1031	3456	5106	1585	3456	5106	1585
Grp Volume(v), veh/h	46	132	40	243	144	77	40	738	384	146	1099	148
Grp Sat Flow(s),veh/h/ln	1728	1777	1585	1728	1702	1685	1728	1702	1585	1728	1702	1585
Q Serve(g_s), s	1.5	4.4	1.3	8.4	5.0	5.4	0.2	14.0	19.6	0.5	22.7	6.9
Cycle Q Clear(g_c), s	1.5	4.4	1.3	8.4	5.0	5.4	0.2	14.0	19.6	0.5	22.7	6.9
Prop In Lane	1.00		1.00	1.00		0.61	1.00		1.00	1.00		1.00
Lane Grp Cap(c), veh/h	263	207	92	301	233	115	1432	1083	336	1561	1274	396
V/C Ratio(X)	0.18	0.64	0.43	0.81	0.62	0.67	0.03	0.68	1.14	0.09	0.86	0.37
Avail Cap(c_a), veh/h	308	930	415	328	916	454	1432	2055	638	1561	2055	638
HCM Platoon Ratio	1.00	1.00	1.00	0.33	0.33	0.33	2.00	2.00	2.00	2.00	2.00	2.00
Upstream Filter(I)	1.00	1.00	1.00	0.88	0.88	0.88	0.95	0.95	0.95	1.00	1.00	1.00
Uniform Delay (d), s/veh	51.9	55.3	11.4	57.3	57.1	57.3	6.0	31.3	20.5	3.2	28.2	24.3
Incr Delay (d2), s/veh	0.1	1.2	1.2	10.4	0.9	2.2	0.0	3.3	92.3	0.0	7.9	2.7
Initial Q Delay(d3),s/veh	0.0	0.0	0.0	0.0	0.0	0.0	0.0	0.0	0.0	0.0	0.0	0.0
%ile BackOfQ(50%),veh/ln	0.6	2.0	1.2	4.2	2.2	2.4	0.1	4.9	13.6	0.2	7.1	2.6
Unsig. Movement Delay, s/veh												
LnGrp Delay(d),s/veh	52.0	56.5	12.6	67.6	58.0	59.4	6.0	34.6	112.8	3.2	36.1	27.0
LnGrp LOS	D	E	B	E	E	E	A	C	F	A	D	C
Approach Vol, veh/h		218			464			1162			1393	
Approach Delay, s/veh		47.5			63.3			59.4			31.7	
Approach LOS		D			E			E			C	
Timer - Assigned Phs	1	2	3	4	5	6	7	8				
Phs Duration (G+Y+Rc), s	55.7	35.6	14.7	13.9	60.2	31.2	16.0	12.6				
Change Period (Y+Rc), s	6.0	5.7	* 5.6	* 5.7	6.0	5.7	5.6	* 5.6				
Max Green Setting (Gmax), s	6.0	48.3	* 11	* 32	6.0	48.3	11.4	* 31				
Max Q Clear Time (g_c+I1), s	2.2	24.7	3.5	7.4	2.5	21.6	10.4	6.4				
Green Ext Time (p_c), s	0.0	5.2	0.0	0.8	0.1	3.8	0.1	0.5				

Intersection Summary

HCM 6th Ctrl Delay	47.2
HCM 6th LOS	D

Notes

User approved pedestrian interval to be less than phase max green.
 * HCM 6th computational engine requires equal clearance times for the phases crossing the barrier.

6: Scottsdale Road & Greenway Parkway/Butherus Drive

08/18/2022

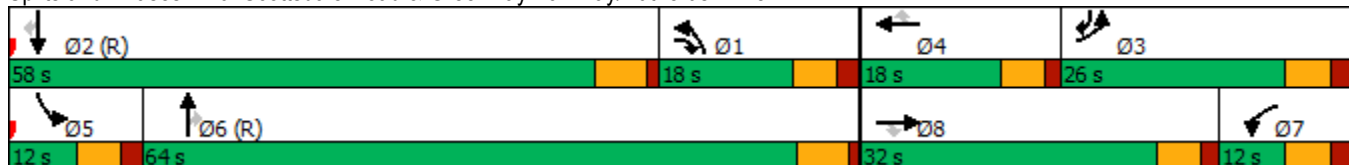


Lane Group	EBL	EBT	EBR	WBL	WBT	WBR	NBL	NBT	NBR	SBL	SBT	SBR
Lane Configurations												
Traffic Volume (vph)	245	348	299	80	58	30	154	788	247	122	1018	87
Future Volume (vph)	245	348	299	80	58	30	154	788	247	122	1018	87
Turn Type	Prot	NA	pm+ov	Prot	NA	Perm	Prot	NA	Perm	Prot	NA	pm+ov
Protected Phases	3	8	1	7	4		1	6		5	2	3
Permitted Phases			8			4			6			2
Detector Phase	3	8	1	7	4	4	1	6	6	5	2	3
Switch Phase												
Minimum Initial (s)	5.0	7.0	5.0	5.0	7.0	7.0	5.0	10.0	10.0	5.0	10.0	5.0
Minimum Split (s)	11.0	13.2	11.0	11.0	13.2	13.2	11.0	16.0	16.0	11.0	16.0	11.0
Total Split (s)	26.0	32.0	18.0	12.0	18.0	18.0	18.0	64.0	64.0	12.0	58.0	26.0
Total Split (%)	21.7%	26.7%	15.0%	10.0%	15.0%	15.0%	15.0%	53.3%	53.3%	10.0%	48.3%	21.7%
Yellow Time (s)	4.0	4.0	4.0	4.0	4.0	4.0	4.0	4.7	4.7	4.0	4.7	4.0
All-Red Time (s)	2.0	1.5	2.0	2.0	1.5	1.5	2.0	1.0	1.0	2.0	1.0	2.0
Lost Time Adjust (s)	0.0	0.0	0.0	0.0	0.0	0.0	0.0	0.0	0.0	0.0	0.0	0.0
Total Lost Time (s)	6.0	5.5	6.0	6.0	5.5	5.5	6.0	5.7	5.7	6.0	5.7	6.0
Lead/Lag	Lag	Lead	Lag	Lag	Lead	Lead	Lag	Lag	Lag	Lead	Lead	Lag
Lead-Lag Optimize?	Yes	Yes	Yes	Yes	Yes	Yes	Yes	Yes	Yes	Yes	Yes	Yes
Recall Mode	None	None	None	None	None	None	None	C-Min	C-Min	None	C-Min	None
Act Effct Green (s)	23.9	21.3	38.0	7.4	7.3	7.3	11.1	58.7	58.7	9.4	56.9	86.5
Actuated g/C Ratio	0.20	0.18	0.32	0.06	0.06	0.06	0.09	0.49	0.49	0.08	0.47	0.72
v/c Ratio	0.39	0.81	0.39	0.41	0.29	0.10	0.53	0.34	0.30	0.50	0.46	0.08
Control Delay	43.3	55.5	12.9	59.5	57.3	0.6	57.2	20.5	5.3	42.2	25.8	1.6
Queue Delay	0.0	0.0	0.0	0.0	0.0	0.0	0.0	0.0	0.0	0.0	0.0	0.0
Total Delay	43.3	55.5	12.9	59.5	57.3	0.6	57.2	20.5	5.3	42.2	25.8	1.6
LOS	D	E	B	E	E	A	E	C	A	D	C	A
Approach Delay		42.7			48.1			22.1			25.7	
Approach LOS		D			D			C			C	

Intersection Summary

Cycle Length: 120
 Actuated Cycle Length: 120
 Offset: 53 (44%), Referenced to phase 2:SBT and 6:NBT, Start of 1st Green
 Natural Cycle: 60
 Control Type: Actuated-Coordinated
 Maximum v/c Ratio: 0.81
 Intersection Signal Delay: 29.9
 Intersection Capacity Utilization 60.4%
 Analysis Period (min) 15
 Intersection LOS: C
 ICU Level of Service B

Splits and Phases: 6: Scottsdale Road & Greenway Parkway/Butherus Drive



6: Scottsdale Road & Greenway Parkway/Butherus Drive

08/18/2022



Movement	EBL	EBT	EBR	WBL	WBT	WBR	NBL	NBT	NBR	SBL	SBT	SBR
Lane Configurations	↔↔	↕↔	↔	↔↔	↕↕	↔	↔↔	↕↕↕	↔	↔↔	↕↕↕	↔
Traffic Volume (veh/h)	245	348	299	80	58	30	154	788	247	122	1018	87
Future Volume (veh/h)	245	348	299	80	58	30	154	788	247	122	1018	87
Initial Q (Qb), veh	0	0	0	0	0	0	0	0	0	0	0	0
Ped-Bike Adj(A_pbT)	1.00		1.00	1.00		1.00	1.00		1.00	1.00		1.00
Parking Bus, Adj	1.00	1.00	1.00	1.00	1.00	1.00	1.00	1.00	1.00	1.00	1.00	1.00
Work Zone On Approach		No			No			No			No	
Adj Sat Flow, veh/h/ln	1870	1870	1870	1870	1870	1870	1870	1870	1870	1870	1870	1870
Adj Flow Rate, veh/h	266	514	234	87	63	33	167	857	0	133	1107	95
Peak Hour Factor	0.92	0.92	0.92	0.92	0.92	0.92	0.92	0.92	0.92	0.92	0.92	0.92
Percent Heavy Veh, %	2	2	2	2	2	2	2	2	2	2	2	2
Cap, veh/h	517	614	818	136	207	92	1216	2812		173	1283	629
Arrive On Green	0.15	0.16	0.16	0.04	0.06	0.06	0.35	0.55	0.00	0.10	0.50	0.50
Sat Flow, veh/h	3563	3741	1585	3456	3554	1585	3456	5106	1585	3456	5106	1585
Grp Volume(v), veh/h	266	514	234	87	63	33	167	857	0	133	1107	95
Grp Sat Flow(s),veh/h/ln	1781	1870	1585	1728	1777	1585	1728	1702	1585	1728	1702	1585
Q Serve(g_s), s	8.3	16.0	0.0	3.0	2.0	2.0	3.9	10.9	0.0	4.5	22.8	0.0
Cycle Q Clear(g_c), s	8.3	16.0	0.0	3.0	2.0	2.0	3.9	10.9	0.0	4.5	22.8	0.0
Prop In Lane	1.00		1.00	1.00		1.00	1.00		1.00	1.00		1.00
Lane Grp Cap(c), veh/h	517	614	818	136	207	92	1216	2812		173	1283	629
V/C Ratio(X)	0.51	0.84	0.29	0.64	0.30	0.36	0.14	0.30		0.77	0.86	0.15
Avail Cap(c_a), veh/h	594	826	908	173	370	165	1216	2812		173	2225	921
HCM Platoon Ratio	1.00	1.00	1.00	1.00	1.00	1.00	1.00	1.00	1.00	2.00	2.00	2.00
Upstream Filter(I)	1.00	1.00	1.00	1.00	1.00	1.00	1.00	1.00	0.00	0.92	0.92	0.92
Uniform Delay (d), s/veh	47.4	48.6	16.5	56.8	54.2	38.8	26.5	14.6	0.0	53.3	28.0	15.1
Incr Delay (d2), s/veh	0.3	4.3	0.1	2.0	0.3	0.9	0.0	0.3	0.0	16.0	7.2	0.5
Initial Q Delay(d3),s/veh	0.0	0.0	0.0	0.0	0.0	0.0	0.0	0.0	0.0	0.0	0.0	0.0
%ile BackOfQ(50%),veh/ln	3.6	7.6	3.5	1.3	0.9	1.0	1.6	4.0	0.0	2.2	7.0	1.2
Unsig. Movement Delay, s/veh												
LnGrp Delay(d),s/veh	47.7	52.9	16.6	58.8	54.5	39.7	26.5	14.8	0.0	69.3	35.3	15.6
LnGrp LOS	D	D	B	E	D	D	C	B		E	D	B
Approach Vol, veh/h		1014			183			1024			1335	
Approach Delay, s/veh		43.2			53.9			16.7			37.3	
Approach LOS		D			D			B			D	
Timer - Assigned Phs	1	2	3	4	5	6	7	8				
Phs Duration (G+Y+Rc), s	48.2	35.9	23.4	12.5	12.0	72.1	10.7	25.2				
Change Period (Y+Rc), s	6.0	5.7	6.0	5.5	6.0	* 6	6.0	5.5				
Max Green Setting (Gmax), s	12.0	52.3	20.0	12.5	6.0	* 58	6.0	26.5				
Max Q Clear Time (g_c+I1), s	5.9	24.8	10.3	4.0	6.5	12.9	5.0	18.0				
Green Ext Time (p_c), s	0.1	5.3	0.3	0.1	0.0	3.9	0.0	1.7				

Intersection Summary

HCM 6th Ctrl Delay	33.9
HCM 6th LOS	C

Notes

- User approved pedestrian interval to be less than phase max green.
- User approved volume balancing among the lanes for turning movement.
- * HCM 6th computational engine requires equal clearance times for the phases crossing the barrier.

Intersection						
Int Delay, s/veh	1.7					
Movement	EBL	EBT	WBT	WBR	SBL	SBR
Lane Configurations						
Traffic Vol, veh/h	26	169	93	15	13	28
Future Vol, veh/h	26	169	93	15	13	28
Conflicting Peds, #/hr	0	0	0	0	0	0
Sign Control	Free	Free	Free	Free	Stop	Stop
RT Channelized	-	None	-	None	-	None
Storage Length	100	-	-	-	0	-
Veh in Median Storage, #	-	0	0	-	0	-
Grade, %	-	0	0	-	0	-
Peak Hour Factor	81	81	81	81	81	81
Heavy Vehicles, %	2	2	2	2	2	2
Mvmt Flow	32	209	115	19	16	35
Major/Minor	Major1	Major2	Minor2			
Conflicting Flow All	134	0	-	0	398	125
Stage 1	-	-	-	-	125	-
Stage 2	-	-	-	-	273	-
Critical Hdwy	4.12	-	-	-	6.42	6.22
Critical Hdwy Stg 1	-	-	-	-	5.42	-
Critical Hdwy Stg 2	-	-	-	-	5.42	-
Follow-up Hdwy	2.218	-	-	-	3.518	3.318
Pot Cap-1 Maneuver	1451	-	-	-	654	926
Stage 1	-	-	-	-	901	-
Stage 2	-	-	-	-	810	-
Platoon blocked, %		-	-	-	1	
Mov Cap-1 Maneuver	1451	-	-	-	640	926
Mov Cap-2 Maneuver	-	-	-	-	675	-
Stage 1	-	-	-	-	881	-
Stage 2	-	-	-	-	810	-
Approach	EB	WB	SB			
HCM Control Delay, s	1	0	9.6			
HCM LOS						A
Minor Lane/Major Mvmt	EBL	EBT	WBT	WBR	SBLn1	
Capacity (veh/h)	1451	-	-	-	828	
HCM Lane V/C Ratio	0.022	-	-	-	0.061	
HCM Control Delay (s)	7.5	-	-	-	9.6	
HCM Lane LOS	A	-	-	-	A	
HCM 95th %tile Q(veh)	0.1	-	-	-	0.2	

Intersection						
Int Delay, s/veh	2.2					
Movement	EBT	EBR	WBL	WBT	NBL	NBR
Lane Configurations						
Traffic Vol, veh/h	136	45	14	78	34	30
Future Vol, veh/h	136	45	14	78	34	30
Conflicting Peds, #/hr	0	0	0	0	0	0
Sign Control	Free	Free	Free	Free	Stop	Stop
RT Channelized	-	None	-	None	-	None
Storage Length	-	-	100	-	80	0
Veh in Median Storage, #	0	-	-	0	0	-
Grade, %	0	-	-	0	0	-
Peak Hour Factor	81	81	81	81	81	81
Heavy Vehicles, %	2	2	2	2	2	2
Mvmt Flow	168	56	17	96	42	37
Major/Minor	Major1	Major2	Minor1			
Conflicting Flow All	0	0	224	0	326	196
Stage 1	-	-	-	-	196	-
Stage 2	-	-	-	-	130	-
Critical Hdwy	-	-	4.12	-	6.42	6.22
Critical Hdwy Stg 1	-	-	-	-	5.42	-
Critical Hdwy Stg 2	-	-	-	-	5.42	-
Follow-up Hdwy	-	-	2.218	-	3.518	3.318
Pot Cap-1 Maneuver	-	-	1363	-	714	916
Stage 1	-	-	-	-	874	-
Stage 2	-	-	-	-	896	-
Platoon blocked, %	-	-	1	-	1	1
Mov Cap-1 Maneuver	-	-	1363	-	706	916
Mov Cap-2 Maneuver	-	-	-	-	724	-
Stage 1	-	-	-	-	874	-
Stage 2	-	-	-	-	885	-
Approach	EB	WB	NB			
HCM Control Delay, s	0	1.2	9.7			
HCM LOS			A			
Minor Lane/Major Mvmt	NBLn1	NBLn2	EBT	EBR	WBL	WBT
Capacity (veh/h)	724	916	-	-	1363	-
HCM Lane V/C Ratio	0.058	0.04	-	-	0.013	-
HCM Control Delay (s)	10.3	9.1	-	-	7.7	-
HCM Lane LOS	B	A	-	-	A	-
HCM 95th %tile Q(veh)	0.2	0.1	-	-	0	-

Intersection						
Int Delay, s/veh	1.9					
Movement	WBL	WBR	NBT	NBR	SBL	SBT
Lane Configurations	↙	↗	↖		↙	↗
Traffic Vol, veh/h	6	8	52	27	22	39
Future Vol, veh/h	6	8	52	27	22	39
Conflicting Peds, #/hr	0	0	0	0	0	0
Sign Control	Stop	Stop	Free	Free	Free	Free
RT Channelized	-	None	-	None	-	None
Storage Length	75	0	-	-	100	-
Veh in Median Storage, #	0	-	0	-	-	0
Grade, %	0	-	0	-	-	0
Peak Hour Factor	79	79	79	79	79	79
Heavy Vehicles, %	2	2	2	2	2	2
Mvmt Flow	8	10	66	34	28	49

Major/Minor	Minor1	Major1	Major2			
Conflicting Flow All	188	83	0	0	100	0
Stage 1	83	-	-	-	-	-
Stage 2	105	-	-	-	-	-
Critical Hdwy	6.42	6.22	-	-	4.12	-
Critical Hdwy Stg 1	5.42	-	-	-	-	-
Critical Hdwy Stg 2	5.42	-	-	-	-	-
Follow-up Hdwy	3.518	3.318	-	-	2.218	-
Pot Cap-1 Maneuver	801	976	-	-	1493	-
Stage 1	940	-	-	-	-	-
Stage 2	919	-	-	-	-	-
Platoon blocked, %			-	-		-
Mov Cap-1 Maneuver	786	976	-	-	1493	-
Mov Cap-2 Maneuver	778	-	-	-	-	-
Stage 1	940	-	-	-	-	-
Stage 2	902	-	-	-	-	-

Approach	WB	NB	SB
HCM Control Delay, s	9.1	0	2.7
HCM LOS	A		

Minor Lane/Major Mvmt	NBT	NBRWBLn1	WBLn2	SBL	SBT
Capacity (veh/h)	-	-	778	976	1493
HCM Lane V/C Ratio	-	-	0.01	0.01	0.019
HCM Control Delay (s)	-	-	9.7	8.7	7.5
HCM Lane LOS	-	-	A	A	A
HCM 95th %tile Q(veh)	-	-	0	0	0.1

Intersection												
Int Delay, s/veh	0.1											
Movement	EBL	EBT	EBR	WBL	WBT	WBR	NBL	NBT	NBR	SBL	SBT	SBR
Lane Configurations		↕			↕		↕	↕		↕	↕	
Traffic Vol, veh/h	0	0	0	0	0	0	0	83	2	1	44	2
Future Vol, veh/h	0	0	0	0	0	0	0	83	2	1	44	2
Conflicting Peds, #/hr	0	0	0	0	0	0	0	0	0	0	0	0
Sign Control	Stop	Stop	Stop	Stop	Stop	Stop	Free	Free	Free	Free	Free	Free
RT Channelized	-	-	None	-	-	None	-	-	None	-	-	None
Storage Length	-	-	-	-	-	-	100	-	-	100	-	-
Veh in Median Storage, #	-	0	-	-	0	-	-	0	-	-	0	-
Grade, %	-	0	-	-	0	-	-	0	-	-	0	-
Peak Hour Factor	81	81	81	81	81	81	81	81	81	81	81	81
Heavy Vehicles, %	2	2	2	2	2	2	2	2	2	2	2	2
Mvmt Flow	0	0	0	0	0	0	0	102	2	1	54	2

Major/Minor	Minor2		Minor1		Major1		Major2					
Conflicting Flow All	160	161	55	160	161	103	56	0	0	104	0	0
Stage 1	57	57	-	103	103	-	-	-	-	-	-	-
Stage 2	103	104	-	57	58	-	-	-	-	-	-	-
Critical Hdwy	7.12	6.52	6.22	7.12	6.52	6.22	4.12	-	-	4.12	-	-
Critical Hdwy Stg 1	6.12	5.52	-	6.12	5.52	-	-	-	-	-	-	-
Critical Hdwy Stg 2	6.12	5.52	-	6.12	5.52	-	-	-	-	-	-	-
Follow-up Hdwy	3.518	4.018	3.318	3.518	4.018	3.318	2.218	-	-	2.218	-	-
Pot Cap-1 Maneuver	806	731	1012	806	731	952	1549	-	-	1488	-	-
Stage 1	955	847	-	903	810	-	-	-	-	-	-	-
Stage 2	903	809	-	955	847	-	-	-	-	-	-	-
Platoon blocked, %								-	-	-	-	-
Mov Cap-1 Maneuver	805	730	1012	805	730	952	1549	-	-	1488	-	-
Mov Cap-2 Maneuver	805	730	-	805	730	-	-	-	-	-	-	-
Stage 1	955	846	-	903	810	-	-	-	-	-	-	-
Stage 2	903	809	-	954	846	-	-	-	-	-	-	-

Approach	EB		WB		NB		SB	
HCM Control Delay, s	0		0		0		0.2	
HCM LOS	A		A					

Minor Lane/Major Mvmt	NBL	NBT	NBR	EBLn1	WBLn1	SBL	SBT	SBR
Capacity (veh/h)	1549	-	-	-	-	1488	-	-
HCM Lane V/C Ratio	-	-	-	-	-	0.001	-	-
HCM Control Delay (s)	0	-	-	0	0	7.4	-	-
HCM Lane LOS	A	-	-	A	A	A	-	-
HCM 95th %tile Q(veh)	0	-	-	-	-	0	-	-

Intersection												
Int Delay, s/veh	0.8											
Movement	EBL	EBT	EBR	WBL	WBT	WBR	NBL	NBT	NBR	SBL	SBT	SBR
Lane Configurations	↶	↷		↶	↷			↕			↕	
Traffic Vol, veh/h	0	105	6	0	114	0	9	0	10	0	0	1
Future Vol, veh/h	0	105	6	0	114	0	9	0	10	0	0	1
Conflicting Peds, #/hr	0	0	0	0	0	0	0	0	0	0	0	0
Sign Control	Free	Free	Free	Free	Free	Free	Stop	Stop	Stop	Stop	Stop	Stop
RT Channelized	-	-	None	-	-	None	-	-	None	-	-	None
Storage Length	100	-	-	100	-	-	-	-	-	-	-	-
Veh in Median Storage, #	-	0	-	-	0	-	-	0	-	-	0	-
Grade, %	-	0	-	-	0	-	-	0	-	-	0	-
Peak Hour Factor	74	74	74	74	74	74	74	74	74	74	74	74
Heavy Vehicles, %	2	2	2	2	2	2	2	2	2	2	2	2
Mvmt Flow	0	142	8	0	154	0	12	0	14	0	0	1

Major/Minor	Major1			Major2			Minor1			Minor2		
Conflicting Flow All	154	0	0	150	0	0	301	300	146	307	304	154
Stage 1	-	-	-	-	-	-	146	146	-	154	154	-
Stage 2	-	-	-	-	-	-	155	154	-	153	150	-
Critical Hdwy	4.12	-	-	4.12	-	-	7.12	6.52	6.22	7.12	6.52	6.22
Critical Hdwy Stg 1	-	-	-	-	-	-	6.12	5.52	-	6.12	5.52	-
Critical Hdwy Stg 2	-	-	-	-	-	-	6.12	5.52	-	6.12	5.52	-
Follow-up Hdwy	2.218	-	-	2.218	-	-	3.518	4.018	3.318	3.518	4.018	3.318
Pot Cap-1 Maneuver	1426	-	-	1431	-	-	651	612	901	645	609	892
Stage 1	-	-	-	-	-	-	857	776	-	848	770	-
Stage 2	-	-	-	-	-	-	847	770	-	849	773	-
Platoon blocked, %	-	-	-	-	-	-	-	-	-	-	-	-
Mov Cap-1 Maneuver	1426	-	-	1431	-	-	650	612	901	635	609	892
Mov Cap-2 Maneuver	-	-	-	-	-	-	650	612	-	635	609	-
Stage 1	-	-	-	-	-	-	857	776	-	848	770	-
Stage 2	-	-	-	-	-	-	846	770	-	836	773	-

Approach	EB			WB			NB			SB		
HCM Control Delay, s	0			0			9.9			9		
HCM LOS							A			A		

Minor Lane/Major Mvmt	NBLn1	EBL	EBT	EBR	WBL	WBT	WBR	SBLn1
Capacity (veh/h)	762	1426	-	-	1431	-	-	892
HCM Lane V/C Ratio	0.034	-	-	-	-	-	-	0.002
HCM Control Delay (s)	9.9	0	-	-	0	-	-	9
HCM Lane LOS	A	A	-	-	A	-	-	A
HCM 95th %tile Q(veh)	0.1	0	-	-	0	-	-	0

Intersection	
Intersection Delay, s/veh	8.7
Intersection LOS	A

Movement	EBL	EBT	EBR	WBL	WBT	WBR	NBL	NBT	NBR	SBL	SBT	SBR
Lane Configurations	↶	↷		↶	↷		↶	↷		↶	↷	
Traffic Vol, veh/h	36	51	41	27	44	6	26	38	12	5	19	17
Future Vol, veh/h	36	51	41	27	44	6	26	38	12	5	19	17
Peak Hour Factor	0.64	0.64	0.64	0.64	0.64	0.64	0.64	0.64	0.64	0.64	0.64	0.64
Heavy Vehicles, %	2	2	2	2	2	2	2	2	2	2	2	2
Mvmt Flow	56	80	64	42	69	9	41	59	19	8	30	27
Number of Lanes	1	1	0	1	1	0	1	1	0	1	1	0

Approach	EB	WB	NB	SB
Opposing Approach	WB	EB	SB	NB
Opposing Lanes	2	2	2	2
Conflicting Approach Left	SB	NB	EB	WB
Conflicting Lanes Left	2	2	2	2
Conflicting Approach Right	NB	SB	WB	EB
Conflicting Lanes Right	2	2	2	2
HCM Control Delay	8.8	8.6	8.8	8.4
HCM LOS	A	A	A	A

Lane	NBLn1	NBLn2	EBLn1	EBLn2	WBLn1	WBLn2	SBLn1	SBLn2
Vol Left, %	100%	0%	100%	0%	100%	0%	100%	0%
Vol Thru, %	0%	76%	0%	55%	0%	88%	0%	53%
Vol Right, %	0%	24%	0%	45%	0%	12%	0%	47%
Sign Control	Stop	Stop	Stop	Stop	Stop	Stop	Stop	Stop
Traffic Vol by Lane	26	50	36	92	27	50	5	36
LT Vol	26	0	36	0	27	0	5	0
Through Vol	0	38	0	51	0	44	0	19
RT Vol	0	12	0	41	0	6	0	17
Lane Flow Rate	41	78	56	144	42	78	8	56
Geometry Grp	7	7	7	7	7	7	7	7
Degree of Util (X)	0.067	0.113	0.088	0.193	0.067	0.111	0.013	0.08
Departure Headway (Hd)	5.903	5.23	5.637	4.821	5.71	5.123	5.973	5.136
Convergence, Y/N	Yes	Yes	Yes	Yes	Yes	Yes	Yes	Yes
Cap	607	684	636	743	627	698	598	696
Service Time	3.643	2.97	3.373	2.557	3.45	2.863	3.717	2.88
HCM Lane V/C Ratio	0.068	0.114	0.088	0.194	0.067	0.112	0.013	0.08
HCM Control Delay	9.1	8.6	8.9	8.7	8.9	8.5	8.8	8.3
HCM Lane LOS	A	A	A	A	A	A	A	A
HCM 95th-tile Q	0.2	0.4	0.3	0.7	0.2	0.4	0	0.3

15: 73rd Street/Dial Boulevard & Greenway Hayden Loop

08/18/2022

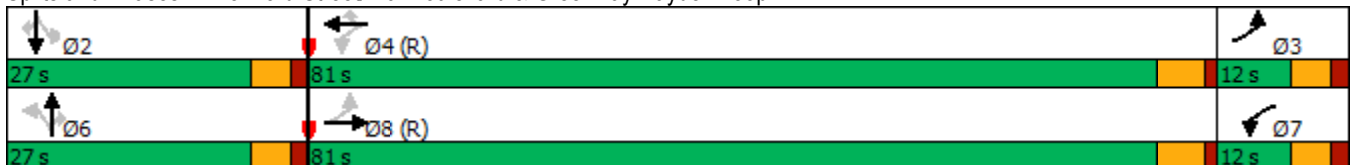


Lane Group	EBL	EBT	WBL	WBT	WBR	NBL	NBT	NBR	SBL	SBT	SBR
Lane Configurations	↘	↕↕↕	↘	↕↕	↗	↘	↕	↗	↘	↕	↗
Traffic Volume (vph)	27	452	175	364	27	32	48	201	69	51	53
Future Volume (vph)	27	452	175	364	27	32	48	201	69	51	53
Turn Type	pm+pt	NA	pm+pt	NA	Perm	Perm	NA	Perm	Perm	NA	Perm
Protected Phases	3	8	7	4			6			2	
Permitted Phases	8		4		4	6		6	2		2
Detector Phase	3	8	7	4	4	6	6	6	2	2	2
Switch Phase											
Minimum Initial (s)	5.0	10.0	5.0	10.0	10.0	7.0	7.0	7.0	7.0	7.0	7.0
Minimum Split (s)	12.0	37.0	37.0	36.0	36.0	37.0	37.0	37.0	37.0	37.0	37.0
Total Split (s)	12.0	81.0	12.0	81.0	81.0	27.0	27.0	27.0	27.0	27.0	27.0
Total Split (%)	10.0%	67.5%	10.0%	67.5%	67.5%	22.5%	22.5%	22.5%	22.5%	22.5%	22.5%
Yellow Time (s)	3.6	4.4	3.6	4.4	4.4	3.6	3.6	3.6	3.6	3.6	3.6
All-Red Time (s)	1.7	1.0	1.7	1.0	1.0	1.6	1.6	1.6	1.6	1.6	1.6
Lost Time Adjust (s)	0.0	0.0	0.0	0.0	0.0	0.0	0.0	0.0	0.0	0.0	0.0
Total Lost Time (s)	5.3	5.4	5.3	5.4	5.4	5.2	5.2	5.2	5.2	5.2	5.2
Lead/Lag	Lag	Lead	Lag	Lead	Lead						
Lead-Lag Optimize?	Yes	Yes	Yes	Yes	Yes						
Recall Mode	Max	C-Min	None	C-Min	C-Min	None	None	None	None	None	None
Act Effct Green (s)	91.6	27.9	93.2	28.6	28.6	11.8	11.8	11.8	11.8	11.8	11.8
Actuated g/C Ratio	0.76	0.23	0.78	0.24	0.24	0.10	0.10	0.10	0.10	0.10	0.10
v/c Ratio	0.03	0.49	0.19	0.51	0.07	0.29	0.31	0.64	0.62	0.33	0.28
Control Delay	3.3	48.2	7.8	28.3	4.2	54.2	53.1	14.5	70.8	53.7	12.4
Queue Delay	0.0	0.0	0.0	0.0	0.0	0.0	0.0	0.0	0.0	0.0	0.0
Total Delay	3.3	48.2	7.8	28.3	4.2	54.2	53.1	14.5	70.8	53.7	12.4
LOS	A	D	A	C	A	D	D	B	E	D	B
Approach Delay		45.9		20.8			25.6			47.9	
Approach LOS		D		C			C			D	

Intersection Summary

Cycle Length: 120
 Actuated Cycle Length: 120
 Offset: 47 (39%), Referenced to phase 4:WBTL and 8:EBTL, Start of Green
 Natural Cycle: 115
 Control Type: Actuated-Coordinated
 Maximum v/c Ratio: 0.64
 Intersection Signal Delay: 33.2
 Intersection LOS: C
 Intersection Capacity Utilization 43.1%
 ICU Level of Service A
 Analysis Period (min) 15

Splits and Phases: 15: 73rd Street/Dial Boulevard & Greenway Hayden Loop



15: 73rd Street/Dial Boulevard & Greenway Hayden Loop

08/18/2022



Movement	EBL	EBT	EBR	WBL	WBT	WBR	NBL	NBT	NBR	SBL	SBT	SBR
Lane Configurations	↖	↕↕↕		↖	↕↕	↖	↖	↕	↖	↖	↖	↖
Traffic Volume (veh/h)	27	452	43	175	364	27	32	48	201	69	51	53
Future Volume (veh/h)	27	452	43	175	364	27	32	48	201	69	51	53
Initial Q (Qb), veh	0	0	0	0	0	0	0	0	0	0	0	0
Ped-Bike Adj(A_pbT)	1.00		1.00	1.00		1.00	1.00		1.00	1.00		1.00
Parking Bus, Adj	1.00	1.00	1.00	1.00	1.00	1.00	1.00	1.00	1.00	1.00	1.00	1.00
Work Zone On Approach		No			No			No			No	
Adj Sat Flow, veh/h/ln	1870	1870	1870	1870	1870	1870	1870	1870	1870	1870	1870	1870
Adj Flow Rate, veh/h	32	532	51	206	428	32	38	56	236	81	60	62
Peak Hour Factor	0.85	0.85	0.85	0.85	0.85	0.85	0.85	0.85	0.85	0.85	0.85	0.85
Percent Heavy Veh, %	2	2	2	2	2	2	2	2	2	2	2	2
Cap, veh/h	1076	716	68	1075	534	238	233	307	261	211	307	261
Arrive On Green	0.18	0.05	0.05	0.55	0.15	0.15	0.16	0.16	0.16	0.16	0.16	0.16
Sat Flow, veh/h	1781	4744	450	1781	3554	1585	1269	1870	1585	1087	1870	1585
Grp Volume(v), veh/h	32	380	203	206	428	32	38	56	236	81	60	62
Grp Sat Flow(s),veh/h/ln	1781	1702	1789	1781	1777	1585	1269	1870	1585	1087	1870	1585
Q Serve(g_s), s	0.0	13.2	13.4	0.0	14.0	2.1	3.2	3.1	17.5	8.3	3.3	4.1
Cycle Q Clear(g_c), s	0.0	13.2	13.4	0.0	14.0	2.1	6.5	3.1	17.5	11.4	3.3	4.1
Prop In Lane	1.00		0.25	1.00		1.00	1.00		1.00	1.00		1.00
Lane Grp Cap(c), veh/h	1076	514	270	1075	534	238	233	307	261	211	307	261
V/C Ratio(X)	0.03	0.74	0.75	0.19	0.80	0.13	0.16	0.18	0.91	0.38	0.20	0.24
Avail Cap(c_a), veh/h	1076	2145	1127	1075	2239	999	255	340	288	229	340	288
HCM Platoon Ratio	0.33	0.33	0.33	1.00	1.00	1.00	1.00	1.00	1.00	1.00	1.00	1.00
Upstream Filter(I)	0.91	0.91	0.91	1.00	1.00	1.00	1.00	1.00	1.00	1.00	1.00	1.00
Uniform Delay (d), s/veh	20.0	54.7	54.8	11.7	49.2	44.2	46.1	43.2	49.2	48.1	43.3	43.6
Incr Delay (d2), s/veh	0.0	8.4	16.0	0.0	12.0	1.2	0.1	0.1	27.1	0.4	0.1	0.2
Initial Q Delay(d3),s/veh	0.0	0.0	0.0	0.0	0.0	0.0	0.0	0.0	0.0	0.0	0.0	0.0
%ile BackOfQ(50%),veh/ln	0.7	6.7	7.7	2.5	7.1	0.9	1.0	1.4	8.9	2.3	1.6	1.6
Unsig. Movement Delay, s/veh												
LnGrp Delay(d),s/veh	20.0	63.1	70.8	11.7	61.2	45.4	46.2	43.3	76.3	48.5	43.4	43.8
LnGrp LOS	C	E	E	B	E	D	D	D	E	D	D	D
Approach Vol, veh/h		615			666			330			203	
Approach Delay, s/veh		63.4			45.1			67.2			45.6	
Approach LOS		E			D			E			D	
Timer - Assigned Phs		2	3	4		6	7	8				
Phs Duration (G+Y+Rc), s		24.9	71.6	23.4		24.9	71.6	23.5				
Change Period (Y+Rc), s		* 5.2	5.3	* 5.4		* 5.2	5.3	* 5.4				
Max Green Setting (Gmax), s		* 22	6.7	* 76		* 22	6.7	* 76				
Max Q Clear Time (g_c+I1), s		13.4	2.0	16.0		19.5	2.0	15.4				
Green Ext Time (p_c), s		0.3	0.0	2.1		0.2	0.1	2.7				

Intersection Summary

HCM 6th Ctrl Delay	55.4
HCM 6th LOS	E

Notes

User approved pedestrian interval to be less than phase max green.
 * HCM 6th computational engine requires equal clearance times for the phases crossing the barrier.

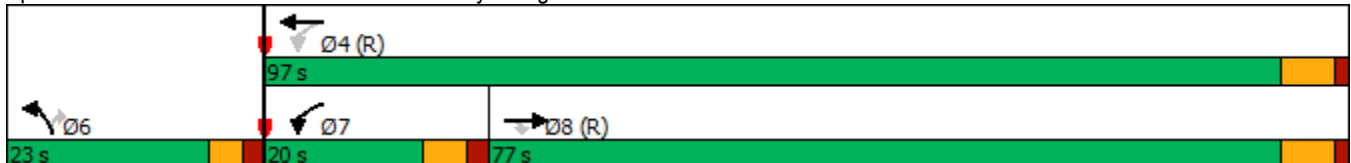


Lane Group	EBT	EBR	WBL	WBT	NBL	NBR
Lane Configurations	↑↑↑	↑	↓	↑↑↑	↓	↓
Traffic Volume (vph)	1264	87	165	756	39	103
Future Volume (vph)	1264	87	165	756	39	103
Turn Type	NA	Perm	pm+pt	NA	Prot	Perm
Protected Phases	8		7	4	6	
Permitted Phases		8	4			6
Detector Phase	8	8	7	4	6	6
Switch Phase						
Minimum Initial (s)	7.0	7.0	5.0	10.0	7.0	7.0
Minimum Split (s)	13.2	13.2	11.0	16.2	12.0	12.0
Total Split (s)	77.0	77.0	20.0	97.0	23.0	23.0
Total Split (%)	64.2%	64.2%	16.7%	80.8%	19.2%	19.2%
Yellow Time (s)	4.7	4.7	4.0	4.7	3.0	3.0
All-Red Time (s)	1.5	1.5	1.9	1.5	2.0	2.0
Lost Time Adjust (s)	0.0	0.0	0.0	0.0	0.0	0.0
Total Lost Time (s)	6.2	6.2	5.9	6.2	5.0	5.0
Lead/Lag	Lag	Lag	Lead			
Lead-Lag Optimize?	Yes	Yes	Yes			
Recall Mode	C-Min	C-Min	None	C-Min	None	None
Act Effct Green (s)	88.7	88.7	101.4	101.1	7.7	7.7
Actuated g/C Ratio	0.74	0.74	0.84	0.84	0.06	0.06
v/c Ratio	0.40	0.09	0.64	0.21	0.21	0.56
Control Delay	2.6	1.3	34.2	0.7	55.0	19.8
Queue Delay	0.0	0.0	0.0	0.0	0.0	0.0
Total Delay	2.6	1.3	34.2	0.7	55.0	19.8
LOS	A	A	C	A	D	B
Approach Delay	2.5			6.7	29.5	
Approach LOS	A			A	C	

Intersection Summary

Cycle Length: 120
 Actuated Cycle Length: 120
 Offset: 75 (63%), Referenced to phase 4:WBTL and 8:EBT, Start of 1st Green
 Natural Cycle: 55
 Control Type: Actuated-Coordinated
 Maximum v/c Ratio: 0.64
 Intersection Signal Delay: 5.7
 Intersection Capacity Utilization 53.6%
 Analysis Period (min) 15
 Intersection LOS: A
 ICU Level of Service A

Splits and Phases: 16: 76th Street & Frank Lloyd Wright Boulevard





Movement	EBT	EBR	WBL	WBT	NBL	NBR	
Lane Configurations	↑↑↑	↑	↓	↑↑↑	↓	↑	
Traffic Volume (veh/h)	1264	87	165	756	39	103	
Future Volume (veh/h)	1264	87	165	756	39	103	
Initial Q (Qb), veh	0	0	0	0	0	0	
Ped-Bike Adj(A_pbT)		1.00	1.00		1.00	1.00	
Parking Bus, Adj	1.00	1.00	1.00	1.00	1.00	1.00	
Work Zone On Approach	No			No	No		
Adj Sat Flow, veh/h/ln	1870	1870	1870	1870	1870	1870	
Adj Flow Rate, veh/h	1487	102	194	889	46	121	
Peak Hour Factor	0.85	0.85	0.85	0.85	0.85	0.85	
Percent Heavy Veh, %	2	2	2	2	2	2	
Cap, veh/h	3672	1140	294	4157	320	147	
Arrive On Green	0.24	0.24	0.09	1.00	0.09	0.09	
Sat Flow, veh/h	5274	1585	1781	5274	3456	1585	
Grp Volume(v), veh/h	1487	102	194	889	46	121	
Grp Sat Flow(s),veh/h/ln	1702	1585	1781	1702	1728	1585	
Q Serve(g_s), s	29.5	6.0	3.5	0.0	1.5	9.0	
Cycle Q Clear(g_c), s	29.5	6.0	3.5	0.0	1.5	9.0	
Prop In Lane		1.00	1.00		1.00	1.00	
Lane Grp Cap(c), veh/h	3672	1140	294	4157	320	147	
V/C Ratio(X)	0.40	0.09	0.66	0.21	0.14	0.82	
Avail Cap(c_a), veh/h	3672	1140	421	4157	518	238	
HCM Platoon Ratio	0.33	0.33	2.00	2.00	1.00	1.00	
Upstream Filter(I)	0.62	0.62	0.91	0.91	1.00	1.00	
Uniform Delay (d), s/veh	24.1	15.2	12.3	0.0	50.1	53.5	
Incr Delay (d2), s/veh	0.2	0.1	0.9	0.1	0.1	5.2	
Initial Q Delay(d3),s/veh	0.0	0.0	0.0	0.0	0.0	0.0	
%ile BackOfQ(50%),veh/ln	13.4	2.0	2.3	0.0	0.6	7.9	
Unsig. Movement Delay, s/veh							
LnGrp Delay(d),s/veh	24.3	15.2	13.2	0.1	50.1	58.7	
LnGrp LOS	C	B	B	A	D	E	
Approach Vol, veh/h	1589			1083	167		
Approach Delay, s/veh	23.7			2.5	56.3		
Approach LOS	C			A	E		
Timer - Assigned Phs				4	6	7	8
Phs Duration (G+Y+Rc), s				103.9	16.1	11.4	92.5
Change Period (Y+Rc), s				6.2	5.0	* 5.9	6.2
Max Green Setting (Gmax), s				90.8	18.0	* 14	70.8
Max Q Clear Time (g_c+I1), s				2.0	11.0	5.5	31.5
Green Ext Time (p_c), s				1.1	0.2	0.0	1.9

Intersection Summary

HCM 6th Ctrl Delay	17.5
HCM 6th LOS	B

Notes

User approved pedestrian interval to be less than phase max green.
 * HCM 6th computational engine requires equal clearance times for the phases crossing the barrier.

Intersection

Intersection Delay, s/veh 9.9

Intersection LOS A

Movement	EBL	EBT	EBR	WBL	WBT	WBR	NBL	NBT	NBR	SBL	SBT	SBR
Lane Configurations												
Traffic Vol, veh/h	31	75	40	17	41	20	3	59	8	26	103	30
Future Vol, veh/h	31	75	40	17	41	20	3	59	8	26	103	30
Peak Hour Factor	0.65	0.65	0.65	0.65	0.65	0.65	0.65	0.65	0.65	0.65	0.65	0.65
Heavy Vehicles, %	2	2	2	2	2	2	2	2	2	2	2	2
Mvmt Flow	48	115	62	26	63	31	5	91	12	40	158	46
Number of Lanes	1	1	0	1	1	0	1	1	0	1	1	0

Approach	EB	WB	NB	SB
Opposing Approach	WB	EB	SB	NB
Opposing Lanes	2	2	2	2
Conflicting Approach Left	SB	NB	EB	WB
Conflicting Lanes Left	2	2	2	2
Conflicting Approach Right	NB	SB	WB	EB
Conflicting Lanes Right	2	2	2	2
HCM Control Delay	10	9.2	9.6	10.4
HCM LOS	A	A	A	B

Lane	NBLn1	NBLn2	EBLn1	EBLn2	WBLn1	WBLn2	SBLn1	SBLn2
Vol Left, %	100%	0%	100%	0%	100%	0%	100%	0%
Vol Thru, %	0%	88%	0%	65%	0%	67%	0%	77%
Vol Right, %	0%	12%	0%	35%	0%	33%	0%	23%
Sign Control	Stop	Stop	Stop	Stop	Stop	Stop	Stop	Stop
Traffic Vol by Lane	3	67	31	115	17	61	26	133
LT Vol	3	0	31	0	17	0	26	0
Through Vol	0	59	0	75	0	41	0	103
RT Vol	0	8	0	40	0	20	0	30
Lane Flow Rate	5	103	48	177	26	94	40	205
Geometry Grp	7	7	7	7	7	7	7	7
Degree of Util (X)	0.008	0.164	0.081	0.263	0.046	0.143	0.067	0.307
Departure Headway (Hd)	6.331	5.742	6.106	5.357	6.337	5.604	6.061	5.398
Convergence, Y/N	Yes	Yes	Yes	Yes	Yes	Yes	Yes	Yes
Cap	569	629	581	663	568	644	586	659
Service Time	4.031	3.442	3.9	3.15	4.041	3.304	3.85	3.186
HCM Lane V/C Ratio	0.009	0.164	0.083	0.267	0.046	0.146	0.068	0.311
HCM Control Delay	9.1	9.6	9.4	10.1	9.3	9.2	9.3	10.6
HCM Lane LOS	A	A	A	B	A	A	A	B
HCM 95th-tile Q	0	0.6	0.3	1.1	0.1	0.5	0.2	1.3

18: Greenway Hayden Loop & Frank Lloyd Wright Boulevard

08/18/2022



Lane Group	EBL	EBT	EBR	WBL	WBT	WBR	NBL	NBT	NBR	SBL	SBT	SBR
Lane Configurations	↖↗	↑↑↑	↖	↖↗	↑↑↑	↖	↖	↑↑	↖	↖↗	↑↑	↖
Traffic Volume (vph)	263	1006	51	474	814	141	11	306	328	197	505	217
Future Volume (vph)	263	1006	51	474	814	141	11	306	328	197	505	217
Turn Type	Prot	NA	Perm	Prot	NA	Perm	Prot	NA	pm+ov	Prot	NA	Perm
Protected Phases	3	8		7	4		1	6	7	5	2	
Permitted Phases			8			4			6			2
Detector Phase	3	8	8	7	4	4	1	6	7	5	2	2
Switch Phase												
Minimum Initial (s)	5.0	10.0	10.0	5.0	10.0	10.0	5.0	7.0	5.0	5.0	7.0	7.0
Minimum Split (s)	11.0	15.9	15.9	11.0	15.9	15.9	11.0	13.0	11.0	11.0	13.0	13.0
Total Split (s)	30.0	54.0	54.0	28.0	52.0	52.0	16.0	26.0	28.0	12.0	22.0	22.0
Total Split (%)	25.0%	45.0%	45.0%	23.3%	43.3%	43.3%	13.3%	21.7%	23.3%	10.0%	18.3%	18.3%
Yellow Time (s)	4.0	4.7	4.7	4.0	4.7	4.7	3.6	4.4	4.0	3.6	4.4	4.4
All-Red Time (s)	2.0	1.0	1.0	2.0	1.0	1.0	2.0	1.2	2.0	2.0	1.2	1.2
Lost Time Adjust (s)	0.0	0.0	0.0	0.0	0.0	0.0	0.0	0.0	0.0	0.0	0.0	0.0
Total Lost Time (s)	6.0	5.7	5.7	6.0	5.7	5.7	5.6	5.6	6.0	5.6	5.6	5.6
Lead/Lag	Lead	Lead	Lead	Lag	Lag	Lag	Lag	Lag	Lag	Lead	Lead	Lead
Lead-Lag Optimize?	Yes	Yes	Yes	Yes	Yes	Yes	Yes	Yes	Yes	Yes	Yes	Yes
Recall Mode	None	C-Min	C-Min	None	C-Min	C-Min	None	None	None	None	None	None
Act Effct Green (s)	13.9	44.0	44.0	22.7	52.8	52.8	6.2	15.6	38.0	14.8	30.6	30.6
Actuated g/C Ratio	0.12	0.37	0.37	0.19	0.44	0.44	0.05	0.13	0.32	0.12	0.26	0.26
v/c Ratio	0.75	0.61	0.08	0.83	0.41	0.20	0.14	0.75	0.63	0.53	0.64	0.43
Control Delay	78.3	25.9	0.8	58.2	24.3	2.9	33.3	35.9	18.2	55.2	44.6	9.6
Queue Delay	0.0	0.0	0.0	0.0	0.0	0.0	0.0	0.0	0.0	0.0	0.0	0.0
Total Delay	78.3	25.9	0.8	58.2	24.3	2.9	33.3	35.9	18.2	55.2	44.6	9.6
LOS	E	C	A	E	C	A	C	D	B	E	D	A
Approach Delay		35.4			33.5			26.9			38.6	
Approach LOS		D			C			C			D	

Intersection Summary

Cycle Length: 120

Actuated Cycle Length: 120

Offset: 93 (78%), Referenced to phase 4:WBT and 8:EBT, Start of 1st Green

Natural Cycle: 75

Control Type: Actuated-Coordinated

Maximum v/c Ratio: 0.83

Intersection Signal Delay: 34.2

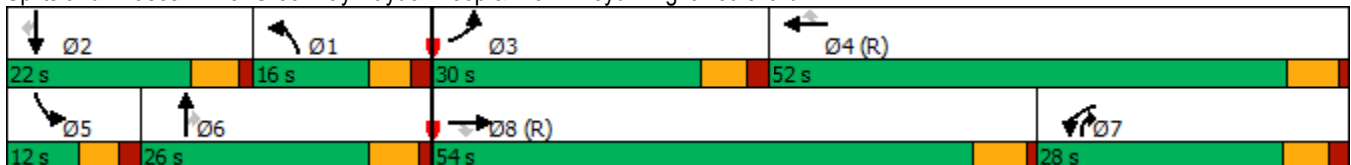
Intersection LOS: C

Intersection Capacity Utilization 70.2%

ICU Level of Service C

Analysis Period (min) 15

Splits and Phases: 18: Greenway Hayden Loop & Frank Lloyd Wright Boulevard



18: Greenway Hayden Loop & Frank Lloyd Wright Boulevard

08/18/2022



Movement	EBL	EBT	EBR	WBL	WBT	WBR	NBL	NBT	NBR	SBL	SBT	SBR
Lane Configurations												
Traffic Volume (veh/h)	263	1006	51	474	814	141	11	306	328	197	505	217
Future Volume (veh/h)	263	1006	51	474	814	141	11	306	328	197	505	217
Initial Q (Qb), veh	0	0	0	0	0	0	0	0	0	0	0	0
Ped-Bike Adj(A_pbT)	1.00		1.00	1.00		1.00	1.00		1.00	1.00		1.00
Parking Bus, Adj	1.00	1.00	1.00	1.00	1.00	1.00	1.00	1.00	1.00	1.00	1.00	1.00
Work Zone On Approach		No			No			No			No	
Adj Sat Flow, veh/h/ln	1870	1870	1870	1870	1870	1870	1870	1870	1870	1870	1870	1870
Adj Flow Rate, veh/h	299	1143	58	539	925	160	12	348	373	224	574	247
Peak Hour Factor	0.88	0.88	0.88	0.88	0.88	0.88	0.88	0.88	0.88	0.88	0.88	0.88
Percent Heavy Veh, %	2	2	2	2	2	2	2	2	2	2	2	2
Cap, veh/h	350	1256	390	1354	2726	846	62	420	808	184	486	217
Arrive On Green	0.20	0.49	0.49	0.39	0.53	0.53	0.03	0.12	0.12	0.05	0.14	0.14
Sat Flow, veh/h	3456	5106	1585	3456	5106	1585	1781	3554	1585	3456	3554	1585
Grp Volume(v), veh/h	299	1143	58	539	925	160	12	348	373	224	574	247
Grp Sat Flow(s),veh/h/ln	1728	1702	1585	1728	1702	1585	1781	1777	1585	1728	1777	1585
Q Serve(g_s), s	10.0	24.7	2.4	13.5	12.4	6.3	0.8	11.5	3.7	6.4	16.4	12.6
Cycle Q Clear(g_c), s	10.0	24.7	2.4	13.5	12.4	6.3	0.8	11.5	3.7	6.4	16.4	12.6
Prop In Lane	1.00		1.00	1.00		1.00	1.00		1.00	1.00		1.00
Lane Grp Cap(c), veh/h	350	1256	390	1354	2726	846	62	420	808	184	486	217
V/C Ratio(X)	0.85	0.91	0.15	0.40	0.34	0.19	0.19	0.83	0.46	1.22	1.18	1.14
Avail Cap(c_a), veh/h	691	2055	638	1354	2726	846	154	604	890	184	486	217
HCM Platoon Ratio	2.00	2.00	2.00	1.00	1.00	1.00	1.00	1.00	1.00	1.00	1.00	1.00
Upstream Filter(I)	0.92	0.92	0.92	1.00	1.00	1.00	1.00	1.00	1.00	1.00	1.00	1.00
Uniform Delay (d), s/veh	47.0	29.3	23.6	26.3	15.9	14.5	56.3	51.7	7.5	56.8	51.8	30.8
Incr Delay (d2), s/veh	2.1	10.6	0.7	0.1	0.3	0.5	0.6	4.3	0.2	136.2	101.3	104.1
Initial Q Delay(d3),s/veh	0.0	0.0	0.0	0.0	0.0	0.0	0.0	0.0	0.0	0.0	0.0	0.0
%ile BackOfQ(50%),veh/ln	3.9	8.0	0.9	5.4	4.6	2.2	0.4	5.3	3.1	6.2	14.0	10.9
Unsig. Movement Delay, s/veh												
LnGrp Delay(d),s/veh	49.1	39.8	24.3	26.4	16.3	15.0	56.8	56.1	7.7	193.0	153.1	134.8
LnGrp LOS	D	D	C	C	B	B	E	E	A	F	F	F
Approach Vol, veh/h		1500			1624			733			1045	
Approach Delay, s/veh		41.1			19.5			31.5			157.3	
Approach LOS		D			B			C			F	
Timer - Assigned Phs	1	2	3	4	5	6	7	8				
Phs Duration (G+Y+Rc), s	9.8	22.0	18.2	70.1	12.0	19.8	53.0	35.2				
Change Period (Y+Rc), s	* 5.6	5.6	6.0	* 6	5.6	* 5.6	6.0	5.7				
Max Green Setting (Gmax), s	* 10	16.4	24.0	* 46	6.4	* 20	22.0	48.3				
Max Q Clear Time (g_c+I1), s	2.8	18.4	12.0	14.4	8.4	13.5	15.5	26.7				
Green Ext Time (p_c), s	0.0	0.0	0.2	2.2	0.0	0.7	0.3	2.8				

Intersection Summary

HCM 6th Ctrl Delay	57.3
HCM 6th LOS	E

Notes

- User approved pedestrian interval to be less than phase max green.
- * HCM 6th computational engine requires equal clearance times for the phases crossing the barrier.

Intersection												
Int Delay, s/veh	0.9											
Movement	EBL	EBT	EBR	WBL	WBT	WBR	NBL	NBT	NBR	SBL	SBT	SBR
Lane Configurations		↕	↗		↕	↗	↖	↕	↗	↖	↕	↗
Traffic Vol, veh/h	6	6	13	11	4	22	14	617	29	47	901	62
Future Vol, veh/h	6	6	13	11	4	22	14	617	29	47	901	62
Conflicting Peds, #/hr	0	0	0	0	0	0	0	0	0	0	0	0
Sign Control	Stop	Stop	Stop	Stop	Stop	Stop	Free	Free	Free	Free	Free	Free
RT Channelized	-	-	None	-	-	None	-	-	None	-	-	None
Storage Length	-	-	130	-	-	130	150	-	-	110	-	175
Veh in Median Storage, #	-	0	-	-	0	-	-	0	-	-	0	-
Grade, %	-	0	-	-	0	-	-	0	-	-	0	-
Peak Hour Factor	94	94	94	94	94	94	94	94	94	94	94	94
Heavy Vehicles, %	2	2	2	2	2	2	2	2	2	2	2	2
Mvmt Flow	6	6	14	12	4	23	15	656	31	50	959	66

Major/Minor	Minor2		Minor1		Major1			Major2				
Conflicting Flow All	1419	1776	480	1269	1811	328	1025	0	0	687	0	0
Stage 1	1059	1059	-	686	686	-	-	-	-	-	-	-
Stage 2	360	717	-	583	1125	-	-	-	-	-	-	-
Critical Hdwy	7.54	6.54	6.94	7.54	6.54	6.94	4.14	-	-	4.14	-	-
Critical Hdwy Stg 1	6.54	5.54	-	6.54	5.54	-	-	-	-	-	-	-
Critical Hdwy Stg 2	6.54	5.54	-	6.54	5.54	-	-	-	-	-	-	-
Follow-up Hdwy	3.52	4.02	3.32	3.52	4.02	3.32	2.22	-	-	2.22	-	-
Pot Cap-1 Maneuver	257	132	*711	*373	123	668	*1063	-	-	903	-	-
Stage 1	635	564	-	*404	446	-	-	-	-	-	-	-
Stage 2	631	432	-	*670	511	-	-	-	-	-	-	-
Platoon blocked, %	1	1	1	1	1	1	1	-	-	-	-	-
Mov Cap-1 Maneuver	228	123	*711	*333	114	668	*1063	-	-	903	-	-
Mov Cap-2 Maneuver	228	123	-	*333	114	-	-	-	-	-	-	-
Stage 1	626	533	-	*398	440	-	-	-	-	-	-	-
Stage 2	594	426	-	*613	483	-	-	-	-	-	-	-

Approach	EB		WB		NB		SB	
HCM Control Delay, s	19.4		15.5		0.2		0.4	
HCM LOS	C		C					

Minor Lane/Major Mvmt	NBL	NBT	NBR	EBLn1	EBLn2	WBLn1	WBLn2	SBL	SBT	SBR
Capacity (veh/h)	* 1063	-	-	160	711	220	668	903	-	-
HCM Lane V/C Ratio	0.014	-	-	0.08	0.019	0.073	0.035	0.055	-	-
HCM Control Delay (s)	8.4	-	-	29.4	10.2	22.6	10.6	9.2	-	-
HCM Lane LOS	A	-	-	D	B	C	B	A	-	-
HCM 95th %tile Q(veh)	0	-	-	0.3	0.1	0.2	0.1	0.2	-	-

Notes
 ~: Volume exceeds capacity \$: Delay exceeds 300s +: Computation Not Defined *: All major volume in platoon

1: Scottsdale Road & Bell Road/Frank Lloyd Wright Boulevard

08/18/2022



Movement	EBL	EBT	EBR	WBL	WBT	WBR	NBL	NBT	NBR	SBL	SBT	SBR
Lane Configurations												
Traffic Volume (veh/h)	275	588	164	132	909	484	257	1181	171	347	951	269
Future Volume (veh/h)	275	588	164	132	909	484	257	1181	171	347	951	269
Initial Q (Qb), veh	0	0	0	0	0	0	0	0	0	0	0	0
Ped-Bike Adj(A_pbT)	1.00		1.00	1.00		1.00	1.00		1.00	1.00		1.00
Parking Bus, Adj	1.00	1.00	1.00	1.00	1.00	1.00	1.00	1.00	1.00	1.00	1.00	1.00
Work Zone On Approach		No			No			No			No	
Adj Sat Flow, veh/h/ln	1870	1870	1870	1870	1870	1870	1870	1870	1870	1870	1870	1870
Adj Flow Rate, veh/h	299	639	178	143	988	526	279	1284	186	377	1034	292
Peak Hour Factor	0.92	0.92	0.92	0.92	0.92	0.92	0.92	0.92	0.92	0.92	0.92	0.92
Percent Heavy Veh, %	2	2	2	2	2	2	2	2	2	2	2	2
Cap, veh/h	317	1375	427	200	1211	693	344	1403	435	690	1477	417
Arrive On Green	0.09	0.27	0.27	0.02	0.08	0.08	0.03	0.09	0.09	0.20	0.37	0.37
Sat Flow, veh/h	3456	5106	1585	3456	5106	1585	3456	5106	1585	3456	3957	1117
Grp Volume(v), veh/h	299	639	178	143	988	526	279	1284	186	377	889	437
Grp Sat Flow(s),veh/h/ln	1728	1702	1585	1728	1702	1585	1728	1702	1585	1728	1702	1669
Q Serve(g_s), s	10.3	12.5	11.1	4.9	22.9	14.3	9.6	29.9	10.5	11.8	26.6	26.6
Cycle Q Clear(g_c), s	10.3	12.5	11.1	4.9	22.9	14.3	9.6	29.9	10.5	11.8	26.6	26.6
Prop In Lane	1.00		1.00	1.00		1.00	1.00		1.00	1.00		0.67
Lane Grp Cap(c), veh/h	317	1375	427	200	1211	693	344	1403	435	690	1271	623
V/C Ratio(X)	0.94	0.46	0.42	0.71	0.82	0.76	0.81	0.92	0.43	0.55	0.70	0.70
Avail Cap(c_a), veh/h	317	1413	439	317	1413	755	547	1455	452	690	1271	623
HCM Platoon Ratio	1.00	1.00	1.00	0.33	0.33	0.33	0.33	0.33	0.33	1.00	1.00	1.00
Upstream Filter(I)	1.00	1.00	1.00	0.94	0.94	0.94	0.89	0.89	0.89	1.00	1.00	1.00
Uniform Delay (d), s/veh	54.2	36.6	36.1	57.9	52.7	37.3	56.9	53.2	28.1	43.1	31.9	31.9
Incr Delay (d2), s/veh	35.6	0.1	0.2	1.7	2.7	3.3	1.9	9.8	2.7	0.5	3.2	6.4
Initial Q Delay(d3),s/veh	0.0	0.0	0.0	0.0	0.0	0.0	0.0	0.0	0.0	0.0	0.0	0.0
%ile BackOfQ(50%),veh/ln	5.9	5.1	4.2	2.2	10.7	6.2	4.4	14.9	4.5	4.9	11.0	11.4
Unsig. Movement Delay, s/veh												
LnGrp Delay(d),s/veh	89.8	36.7	36.3	59.5	55.4	40.6	58.9	63.0	30.8	43.7	35.1	38.4
LnGrp LOS	F	D	D	E	E	D	E	E	C	D	D	D
Approach Vol, veh/h		1116			1657			1749			1703	
Approach Delay, s/veh		50.9			51.0			58.9			37.8	
Approach LOS		D			D			E			D	
Timer - Assigned Phs	1	2	3	4	5	6	7	8				
Phs Duration (G+Y+Rc), s	17.9	50.8	17.0	34.3	30.0	38.8	13.0	38.3				
Change Period (Y+Rc), s	6.0	* 6	* 6	5.8	* 6	5.8	6.0	* 6				
Max Green Setting (Gmax), s	19.0	* 33	* 11	33.2	* 18	34.2	11.0	* 33				
Max Q Clear Time (g_c+I1), s	11.6	28.6	12.3	24.9	13.8	31.9	6.9	14.5				
Green Ext Time (p_c), s	0.3	1.6	0.0	3.6	0.3	1.0	0.1	1.4				

Intersection Summary

HCM 6th Ctrl Delay	49.6
HCM 6th LOS	D

Notes

- User approved pedestrian interval to be less than phase max green.
- * HCM 6th computational engine requires equal clearance times for the phases crossing the barrier.

2: Scottsdale Road & Paradise Lane

08/18/2022

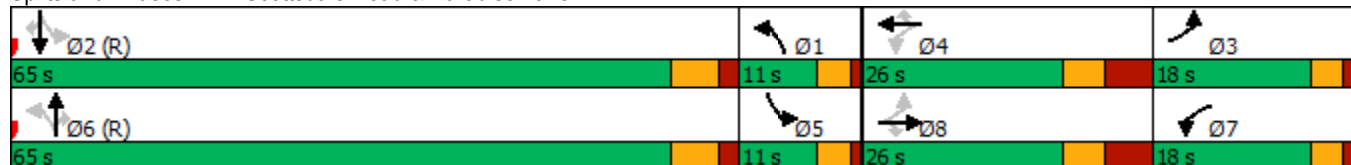


Lane Group	EBL	EBT	EBR	WBL	WBT	WBR	NBL	NBT	NBR	SBL	SBT	SBR
Lane Configurations	↘	↑	↗	↘	↑	↗	↘	↑↑↑	↗	↘	↑↑↑	↗
Traffic Volume (vph)	92	24	16	120	26	153	11	1343	63	49	1119	23
Future Volume (vph)	92	24	16	120	26	153	11	1343	63	49	1119	23
Turn Type	pm+pt	NA	Perm	pm+pt	NA	Perm	pm+pt	NA	Perm	pm+pt	NA	Perm
Protected Phases	3	8		7	4		1	6		5	2	
Permitted Phases	8		8	4		4	6		6	2		2
Detector Phase	3	8	8	7	4	4	1	6	6	5	2	2
Switch Phase												
Minimum Initial (s)	4.0	7.0	7.0	4.0	7.0	7.0	4.0	10.0	10.0	4.0	10.0	10.0
Minimum Split (s)	10.0	15.0	15.0	11.0	15.0	15.0	11.0	16.0	16.0	11.0	16.0	16.0
Total Split (s)	18.0	26.0	26.0	18.0	26.0	26.0	11.0	65.0	65.0	11.0	65.0	65.0
Total Split (%)	15.0%	21.7%	21.7%	15.0%	21.7%	21.7%	9.2%	54.2%	54.2%	9.2%	54.2%	54.2%
Yellow Time (s)	3.0	3.7	3.7	3.0	3.7	3.7	3.0	4.3	4.3	3.0	4.3	4.3
All-Red Time (s)	1.0	4.3	4.3	1.0	4.3	4.3	1.0	1.7	1.7	1.0	1.7	1.7
Lost Time Adjust (s)	0.0	0.0	0.0	0.0	0.0	0.0	0.0	0.0	0.0	0.0	0.0	0.0
Total Lost Time (s)	4.0	8.0	8.0	4.0	8.0	8.0	4.0	6.0	6.0	4.0	6.0	6.0
Lead/Lag	Lag	Lead	Lead	Lag	Lead	Lead	Lag	Lead	Lead	Lag	Lead	Lead
Lead-Lag Optimize?	Yes	Yes	Yes	Yes	Yes	Yes	Yes	Yes	Yes	Yes	Yes	Yes
Recall Mode	None	None	None	None	None	None	None	C-Min	C-Min	None	C-Min	C-Min
Act Effct Green (s)	13.1	7.3	7.3	20.8	8.1	8.1	86.1	79.3	79.3	89.1	84.6	84.6
Actuated g/C Ratio	0.11	0.06	0.06	0.17	0.07	0.07	0.72	0.66	0.66	0.74	0.70	0.70
v/c Ratio	0.53	0.23	0.09	0.46	0.22	0.64	0.04	0.43	0.06	0.20	0.34	0.02
Control Delay	56.0	58.7	0.9	49.8	56.5	19.3	4.4	10.7	0.6	4.7	5.8	0.0
Queue Delay	0.0	0.0	0.0	0.0	0.0	0.0	0.0	0.0	0.0	0.0	0.0	0.0
Total Delay	56.0	58.7	0.9	49.8	56.5	19.3	4.4	10.7	0.6	4.7	5.8	0.0
LOS	E	E	A	D	E	B	A	B	A	A	A	A
Approach Delay		49.9			34.8			10.2			5.6	
Approach LOS		D			C			B			A	

Intersection Summary

Cycle Length: 120
 Actuated Cycle Length: 120
 Offset: 49 (41%), Referenced to phase 2:SBTL and 6:NBTL, Start of 1st Green
 Natural Cycle: 60
 Control Type: Actuated-Coordinated
 Maximum v/c Ratio: 0.64
 Intersection Signal Delay: 12.5
 Intersection Capacity Utilization 57.6%
 Analysis Period (min) 15
 Intersection LOS: B
 ICU Level of Service B

Splits and Phases: 2: Scottsdale Road & Paradise Lane



2: Scottsdale Road & Paradise Lane

08/18/2022



Movement	EBL	EBT	EBR	WBL	WBT	WBR	NBL	NBT	NBR	SBL	SBT	SBR
Lane Configurations	↖	↗	↘	↖	↗	↘	↖	↗↘	↗	↖	↗↘	↘
Traffic Volume (veh/h)	92	24	16	120	26	153	11	1343	63	49	1119	23
Future Volume (veh/h)	92	24	16	120	26	153	11	1343	63	49	1119	23
Initial Q (Qb), veh	0	0	0	0	0	0	0	0	0	0	0	0
Ped-Bike Adj(A_pbT)	1.00		1.00	1.00		1.00	1.00		1.00	1.00		1.00
Parking Bus, Adj	1.00	1.00	1.00	1.00	1.00	1.00	1.00	1.00	1.00	1.00	1.00	1.00
Work Zone On Approach		No			No			No			No	
Adj Sat Flow, veh/h/ln	1870	1870	1870	1870	1870	1870	1870	1870	1870	1870	1870	1870
Adj Flow Rate, veh/h	100	26	17	130	28	166	12	1460	68	53	1216	25
Peak Hour Factor	0.92	0.92	0.92	0.92	0.92	0.92	0.92	0.92	0.92	0.92	0.92	0.92
Percent Heavy Veh, %	2	2	2	2	2	2	2	2	2	2	2	2
Cap, veh/h	171	109	92	273	225	191	776	1609	500	681	1354	420
Arrive On Green	0.03	0.06	0.06	0.09	0.12	0.12	0.13	0.10	0.10	0.12	0.09	0.09
Sat Flow, veh/h	1781	1870	1585	1781	1870	1585	1781	5106	1585	1781	5106	1585
Grp Volume(v), veh/h	100	26	17	130	28	166	12	1460	68	53	1216	25
Grp Sat Flow(s),veh/h/ln	1781	1870	1585	1781	1870	1585	1781	1702	1585	1781	1702	1585
Q Serve(g_s), s	0.0	1.6	1.2	0.9	1.6	12.3	0.0	33.9	4.7	0.0	28.3	1.7
Cycle Q Clear(g_c), s	0.0	1.6	1.2	0.9	1.6	12.3	0.0	33.9	4.7	0.0	28.3	1.7
Prop In Lane	1.00		1.00	1.00		1.00	1.00		1.00	1.00		1.00
Lane Grp Cap(c), veh/h	171	109	92	273	225	191	776	1609	500	681	1354	420
V/C Ratio(X)	0.59	0.24	0.18	0.48	0.12	0.87	0.02	0.91	0.14	0.08	0.90	0.06
Avail Cap(c_a), veh/h	321	281	238	313	281	238	776	2510	779	681	2510	779
HCM Platoon Ratio	1.00	1.00	1.00	1.00	1.00	1.00	0.33	0.33	0.33	0.33	0.33	0.33
Upstream Filter(I)	1.00	1.00	1.00	1.00	1.00	1.00	1.00	1.00	1.00	0.63	0.63	0.63
Uniform Delay (d), s/veh	54.8	54.0	53.8	48.6	47.1	51.8	31.0	52.0	38.9	34.6	53.1	41.0
Incr Delay (d2), s/veh	1.2	0.4	0.4	0.5	0.1	20.6	0.0	9.0	0.6	0.0	6.5	0.2
Initial Q Delay(d3),s/veh	0.0	0.0	0.0	0.0	0.0	0.0	0.0	0.0	0.0	0.0	0.0	0.0
%ile BackOfQ(50%),veh/ln	3.0	0.8	0.5	3.6	0.8	6.0	0.3	16.8	2.0	1.3	13.7	0.7
Unsig. Movement Delay, s/veh												
LnGrp Delay(d),s/veh	56.0	54.4	54.1	49.1	47.2	72.4	31.0	61.0	39.5	34.6	59.6	41.2
LnGrp LOS	E	D	D	D	D	E	C	E	D	C	E	D
Approach Vol, veh/h		143			324			1540			1294	
Approach Delay, s/veh		55.4			60.9			59.8			58.2	
Approach LOS		E			E			E			E	
Timer - Assigned Phs	1	2	3	4	5	6	7	8				
Phs Duration (G+Y+Rc), s	51.9	37.8	7.9	22.5	45.9	43.8	15.3	15.0				
Change Period (Y+Rc), s	* 4	6.0	* 4	8.0	* 4	6.0	* 4	8.0				
Max Green Setting (Gmax), s	* 7	59.0	* 14	18.0	* 7	59.0	* 14	18.0				
Max Q Clear Time (g_c+I1), s	2.0	30.3	2.0	14.3	2.0	35.9	2.9	3.6				
Green Ext Time (p_c), s	0.0	1.5	0.1	0.1	0.0	1.9	0.1	0.1				

Intersection Summary

HCM 6th Ctrl Delay	59.1
HCM 6th LOS	E

Notes

- User approved pedestrian interval to be less than phase max green.
- * HCM 6th computational engine requires equal clearance times for the phases crossing the barrier.

3: Scottsdale Road & Driveway A

08/18/2022

Intersection						
Int Delay, s/veh	0					
Movement	EBL	EBR	NBL	NBT	SBT	SBR
Lane Configurations		↗	↘	↑↑↑	↑↑↑	↗
Traffic Vol, veh/h	0	2	2	1409	1268	1
Future Vol, veh/h	0	2	2	1409	1268	1
Conflicting Peds, #/hr	0	0	0	0	0	0
Sign Control	Stop	Stop	Free	Free	Free	Free
RT Channelized	-	None	-	None	-	None
Storage Length	-	0	110	-	-	110
Veh in Median Storage, #	0	-	-	0	0	-
Grade, %	0	-	-	0	0	-
Peak Hour Factor	92	92	92	92	92	92
Heavy Vehicles, %	2	2	2	2	2	2
Mvmt Flow	0	2	2	1532	1378	1

Major/Minor	Minor2	Major1	Major2		
Conflicting Flow All	-	689	1379	0	-
Stage 1	-	-	-	-	-
Stage 2	-	-	-	-	-
Critical Hdwy	-	7.14	5.34	-	-
Critical Hdwy Stg 1	-	-	-	-	-
Critical Hdwy Stg 2	-	-	-	-	-
Follow-up Hdwy	-	3.92	3.12	-	-
Pot Cap-1 Maneuver	0	*632	*794	-	-
Stage 1	0	-	-	-	-
Stage 2	0	-	-	-	-
Platoon blocked, %		1	1	-	-
Mov Cap-1 Maneuver	-	*632	*794	-	-
Mov Cap-2 Maneuver	-	-	-	-	-
Stage 1	-	-	-	-	-
Stage 2	-	-	-	-	-

Approach	EB	NB	SB
HCM Control Delay, s	10.7	0	0
HCM LOS	B		

Minor Lane/Major Mvmt	NBL	NBT	EBLn1	SBT	SBR
Capacity (veh/h)	* 794	-	632	-	-
HCM Lane V/C Ratio	0.003	-	0.003	-	-
HCM Control Delay (s)	9.5	-	10.7	-	-
HCM Lane LOS	A	-	B	-	-
HCM 95th %tile Q(veh)	0	-	0	-	-

Notes
 ~: Volume exceeds capacity \$: Delay exceeds 300s +: Computation Not Defined *: All major volume in platoon

Intersection												
Int Delay, s/veh	1.1											
Movement	EBL	EBT	EBR	WBL	WBT	WBR	NBL	NBT	NBR	SBL	SBT	SBR
Lane Configurations	↶	↷		↶	↷	↶	↶	↶↶↶	↶	↶	↶↶↶	↶
Traffic Vol, veh/h	9	2	29	12	1	111	28	1301	41	64	1199	11
Future Vol, veh/h	9	2	29	12	1	111	28	1301	41	64	1199	11
Conflicting Peds, #/hr	0	0	0	0	0	0	0	0	0	0	0	0
Sign Control	Stop	Stop	Stop	Stop	Stop	Stop	Free	Free	Free	Free	Free	Free
RT Channelized	-	-	None	-	-	None	-	-	None	-	-	None
Storage Length	100	-	-	80	-	115	200	-	205	195	-	100
Veh in Median Storage, #	-	0	-	-	0	-	-	0	-	-	0	-
Grade, %	-	0	-	-	0	-	-	0	-	-	0	-
Peak Hour Factor	92	92	92	92	92	92	92	92	92	92	92	92
Heavy Vehicles, %	2	2	2	2	2	2	2	2	2	2	2	2
Mvmt Flow	10	2	32	13	1	121	30	1414	45	70	1303	12

Major/Minor	Minor2		Minor1		Major1			Major2				
Conflicting Flow All	2069	2962	652	2136	2929	707	1315	0	0	1459	0	0
Stage 1	1443	1443	-	1474	1474	-	-	-	-	-	-	-
Stage 2	626	1519	-	662	1455	-	-	-	-	-	-	-
Critical Hdwy	6.44	6.54	7.14	6.44	6.54	7.14	5.34	-	-	5.34	-	-
Critical Hdwy Stg 1	7.34	5.54	-	7.34	5.54	-	-	-	-	-	-	-
Critical Hdwy Stg 2	6.74	5.54	-	6.74	5.54	-	-	-	-	-	-	-
Follow-up Hdwy	3.82	4.02	3.92	3.82	4.02	3.92	3.12	-	-	3.12	-	-
Pot Cap-1 Maneuver	*378	151	*653	*378	169	*632	797	-	-	726	-	-
Stage 1	*489	519	-	*552	555	-	-	-	-	-	-	-
Stage 2	*648	520	-	*670	509	-	-	-	-	-	-	-
Platoon blocked, %	1	1	1	1	1	1	1	-	-	1	-	-
Mov Cap-1 Maneuver	*273	132	*653	*320	147	*632	797	-	-	726	-	-
Mov Cap-2 Maneuver	*273	132	-	*320	147	-	-	-	-	-	-	-
Stage 1	*470	469	-	*531	533	-	-	-	-	-	-	-
Stage 2	*504	500	-	*574	461	-	-	-	-	-	-	-

Approach	EB		WB		NB			SB		
HCM Control Delay, s	13.8		12.6		0.2			0.5		
HCM LOS	B		B							

Minor Lane/Major Mvmt	NBL	NBT	NBR	EBLn1	EBLn2	WBLn1	WBLn2	WBLn3	SBL	SBT	SBR
Capacity (veh/h)	797	-	-	273	520	320	147	632	726	-	-
HCM Lane V/C Ratio	0.038	-	-	0.036	0.065	0.041	0.007	0.191	0.096	-	-
HCM Control Delay (s)	9.7	-	-	18.7	12.4	16.7	29.7	12	10.5	-	-
HCM Lane LOS	A	-	-	C	B	C	D	B	B	-	-
HCM 95th %tile Q(veh)	0.1	-	-	0.1	0.2	0.1	0	0.7	0.3	-	-

Notes
 ~: Volume exceeds capacity \$: Delay exceeds 300s +: Computation Not Defined *: All major volume in platoon

5: Scottsdale Road & Kierland Boulevard/Greenway Hayden Loop

08/18/2022



Movement	EBL	EBT	EBR	WBL	WBT	WBR	NBL	NBT	NBR	SBL	SBT	SBR
Lane Configurations	↔↔	↑↑	↗	↔↔	↑↑↔		↔↔	↑↑↑	↗	↔↔	↑↑↑	↗
Traffic Volume (veh/h)	152	169	69	336	325	124	105	1062	250	190	840	197
Future Volume (veh/h)	152	169	69	336	325	124	105	1062	250	190	840	197
Initial Q (Qb), veh	0	0	0	0	0	0	0	0	0	0	0	0
Ped-Bike Adj(A_pbT)	1.00		1.00	1.00		1.00	1.00		1.00	1.00		1.00
Parking Bus, Adj	1.00	1.00	1.00	1.00	1.00	1.00	1.00	1.00	1.00	1.00	1.00	1.00
Work Zone On Approach		No			No			No			No	
Adj Sat Flow, veh/h/ln	1870	1870	1870	1870	1870	1870	1870	1870	1870	1870	1870	1870
Adj Flow Rate, veh/h	173	192	78	382	369	141	119	1207	284	216	955	224
Peak Hour Factor	0.88	0.88	0.88	0.88	0.88	0.88	0.88	0.88	0.88	0.88	0.88	0.88
Percent Heavy Veh, %	2	2	2	2	2	2	2	2	2	2	2	2
Cap, veh/h	231	273	122	441	505	183	1328	1349	419	1177	1125	349
Arrive On Green	0.07	0.08	0.08	0.04	0.05	0.05	0.77	0.53	0.53	0.68	0.44	0.44
Sat Flow, veh/h	3456	3554	1585	3456	3693	1340	3456	5106	1585	3456	5106	1585
Grp Volume(v), veh/h	173	192	78	382	339	171	119	1207	284	216	955	224
Grp Sat Flow(s),veh/h/ln	1728	1777	1585	1728	1702	1629	1728	1702	1585	1728	1702	1585
Q Serve(g_s), s	5.9	6.3	2.7	13.2	11.8	12.5	1.0	25.4	11.0	2.7	20.1	13.2
Cycle Q Clear(g_c), s	5.9	6.3	2.7	13.2	11.8	12.5	1.0	25.4	11.0	2.7	20.1	13.2
Prop In Lane	1.00		1.00	1.00		0.82	1.00		1.00	1.00		1.00
Lane Grp Cap(c), veh/h	231	273	122	441	465	223	1328	1349	419	1177	1125	349
V/C Ratio(X)	0.75	0.70	0.64	0.87	0.73	0.77	0.09	0.90	0.68	0.18	0.85	0.64
Avail Cap(c_a), veh/h	423	930	415	472	945	452	1328	1587	493	1177	1757	546
HCM Platoon Ratio	1.00	1.00	1.00	0.33	0.33	0.33	2.00	2.00	2.00	2.00	2.00	2.00
Upstream Filter(I)	1.00	1.00	1.00	0.95	0.95	0.95	0.86	0.86	0.86	1.00	1.00	1.00
Uniform Delay (d), s/veh	55.0	54.0	12.3	56.5	55.1	55.4	8.7	26.8	12.0	13.0	31.8	29.9
Incr Delay (d2), s/veh	1.8	1.2	2.1	13.4	0.8	2.0	0.0	8.3	7.4	0.0	8.0	8.7
Initial Q Delay(d3),s/veh	0.0	0.0	0.0	0.0	0.0	0.0	0.0	0.0	0.0	0.0	0.0	0.0
%ile BackOfQ(50%),veh/ln	2.6	2.9	2.3	6.9	5.4	5.6	0.4	7.6	3.7	1.0	6.8	4.9
Unsig. Movement Delay, s/veh												
LnGrp Delay(d),s/veh	56.8	55.3	14.4	69.8	55.9	57.5	8.7	35.1	19.4	13.1	39.8	38.6
LnGrp LOS	E	E	B	E	E	E	A	D	B	B	D	D
Approach Vol, veh/h		443			892			1610			1395	
Approach Delay, s/veh		48.7			62.2			30.4			35.5	
Approach LOS		D			E			C			D	
Timer - Assigned Phs	1	2	3	4	5	6	7	8				
Phs Duration (G+Y+Rc), s	52.1	32.1	13.6	22.1	46.9	37.4	20.9	14.8				
Change Period (Y+Rc), s	6.0	5.7	* 5.6	* 5.7	6.0	5.7	5.6	* 5.6				
Max Green Setting (Gmax), s	8.0	41.3	* 15	* 33	12.0	37.3	16.4	* 31				
Max Q Clear Time (g_c+I1), s	3.0	22.1	7.9	14.5	4.7	27.4	15.2	8.3				
Green Ext Time (p_c), s	0.1	4.4	0.2	1.9	0.2	4.3	0.1	0.8				

Intersection Summary

HCM 6th Ctrl Delay	40.4
HCM 6th LOS	D

Notes

User approved pedestrian interval to be less than phase max green.
 * HCM 6th computational engine requires equal clearance times for the phases crossing the barrier.

6: Scottsdale Road & Greenway Parkway/Butherus Drive

08/18/2022

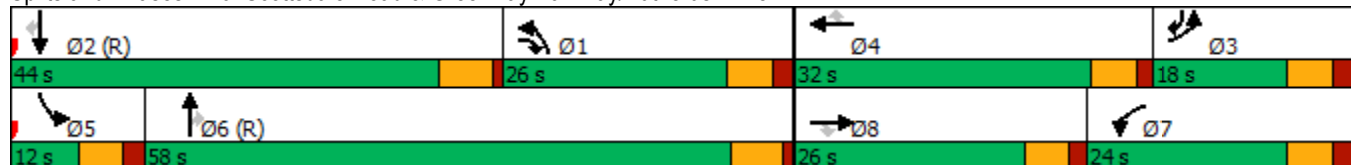


Lane Group	EBL	EBT	EBR	WBL	WBT	WBR	NBL	NBT	NBR	SBL	SBT	SBR
Lane Configurations	↔↔	↕↔	↔	↔↔	↕↕	↔	↔↔	↕↕↕	↔	↔↔	↕↕↕	↔
Traffic Volume (vph)	210	182	167	273	364	195	378	1033	215	91	983	150
Future Volume (vph)	210	182	167	273	364	195	378	1033	215	91	983	150
Turn Type	Prot	NA	pm+ov	Prot	NA	Perm	Prot	NA	Perm	Prot	NA	pm+ov
Protected Phases	3	8	1	7	4		1	6		5	2	3
Permitted Phases			8			4			6			2
Detector Phase	3	8	1	7	4	4	1	6	6	5	2	3
Switch Phase												
Minimum Initial (s)	5.0	7.0	5.0	5.0	7.0	7.0	5.0	10.0	10.0	5.0	10.0	5.0
Minimum Split (s)	11.0	13.2	11.0	11.0	13.2	13.2	11.0	16.0	16.0	11.0	16.0	11.0
Total Split (s)	18.0	26.0	26.0	24.0	32.0	32.0	26.0	58.0	58.0	12.0	44.0	18.0
Total Split (%)	15.0%	21.7%	21.7%	20.0%	26.7%	26.7%	21.7%	48.3%	48.3%	10.0%	36.7%	15.0%
Yellow Time (s)	4.0	4.0	4.0	4.0	4.0	4.0	4.0	4.7	4.7	4.0	4.7	4.0
All-Red Time (s)	2.0	1.5	2.0	2.0	1.5	1.5	2.0	1.0	1.0	2.0	1.0	2.0
Lost Time Adjust (s)	0.0	0.0	0.0	0.0	0.0	0.0	0.0	0.0	0.0	0.0	0.0	0.0
Total Lost Time (s)	6.0	5.5	6.0	6.0	5.5	5.5	6.0	5.7	5.7	6.0	5.7	6.0
Lead/Lag	Lag	Lead	Lag	Lag	Lead	Lead	Lag	Lag	Lag	Lead	Lead	Lag
Lead-Lag Optimize?	Yes	Yes	Yes	Yes	Yes	Yes	Yes	Yes	Yes	Yes	Yes	Yes
Recall Mode	None	None	None	None	None	None	None	C-Min	C-Min	None	C-Min	None
Act Effct Green (s)	12.2	13.1	36.8	17.3	18.2	18.2	18.2	59.3	59.3	7.0	48.2	66.1
Actuated g/C Ratio	0.10	0.11	0.31	0.14	0.15	0.15	0.15	0.49	0.49	0.06	0.40	0.55
v/c Ratio	0.66	0.69	0.21	0.60	0.74	0.54	0.80	0.45	0.27	0.50	0.53	0.18
Control Delay	61.2	55.1	1.2	53.1	57.2	14.0	61.0	21.4	6.2	76.7	17.0	2.8
Queue Delay	0.0	0.0	0.0	0.0	0.0	0.0	0.0	0.0	0.0	0.0	0.0	0.0
Total Delay	61.2	55.1	1.2	53.1	57.2	14.0	61.0	21.4	6.2	76.7	17.0	2.8
LOS	E	E	A	D	E	B	E	C	A	E	B	A
Approach Delay		47.1			45.8			28.6			19.7	
Approach LOS		D			D			C			B	

Intersection Summary

Cycle Length: 120
 Actuated Cycle Length: 120
 Offset: 97 (81%), Referenced to phase 2:SBT and 6:NBT, Start of 1st Green
 Natural Cycle: 60
 Control Type: Actuated-Coordinated
 Maximum v/c Ratio: 0.80
 Intersection Signal Delay: 31.8
 Intersection Capacity Utilization 65.2%
 Analysis Period (min) 15
 Intersection LOS: C
 ICU Level of Service C

Splits and Phases: 6: Scottsdale Road & Greenway Parkway/Butherus Drive



6: Scottsdale Road & Greenway Parkway/Butherus Drive

08/18/2022



Movement	EBL	EBT	EBR	WBL	WBT	WBR	NBL	NBT	NBR	SBL	SBT	SBR
Lane Configurations	↔↔	↕↔	↔	↔↔	↕↕	↔	↔↔	↕↕↕	↔	↔↔	↕↕↕	↔
Traffic Volume (veh/h)	210	182	167	273	364	195	378	1033	215	91	983	150
Future Volume (veh/h)	210	182	167	273	364	195	378	1033	215	91	983	150
Initial Q (Qb), veh	0	0	0	0	0	0	0	0	0	0	0	0
Ped-Bike Adj(A_pbT)	1.00		1.00	1.00		1.00	1.00		1.00	1.00		1.00
Parking Bus, Adj	1.00	1.00	1.00	1.00	1.00	1.00	1.00	1.00	1.00	1.00	1.00	1.00
Work Zone On Approach		No			No			No			No	
Adj Sat Flow, veh/h/ln	1870	1870	1870	1870	1870	1870	1870	1870	1870	1870	1870	1870
Adj Flow Rate, veh/h	231	284	128	300	400	214	415	1135	0	100	1080	165
Peak Hour Factor	0.91	0.91	0.91	0.91	0.91	0.91	0.91	0.91	0.91	0.91	0.91	0.91
Percent Heavy Veh, %	2	2	2	2	2	2	2	2	2	2	2	2
Cap, veh/h	289	368	697	433	506	226	1179	2744		149	1235	512
Arrive On Green	0.08	0.10	0.10	0.13	0.14	0.14	0.34	0.54	0.00	0.09	0.48	0.48
Sat Flow, veh/h	3563	3741	1585	3456	3554	1585	3456	5106	1585	3456	5106	1585
Grp Volume(v), veh/h	231	284	128	300	400	214	415	1135	0	100	1080	165
Grp Sat Flow(s),veh/h/ln	1781	1870	1585	1728	1777	1585	1728	1702	1585	1728	1702	1585
Q Serve(g_s), s	7.6	8.9	0.0	10.0	13.1	13.5	10.8	15.9	0.0	3.4	22.7	0.0
Cycle Q Clear(g_c), s	7.6	8.9	0.0	10.0	13.1	13.5	10.8	15.9	0.0	3.4	22.7	0.0
Prop In Lane	1.00		1.00	1.00		1.00	1.00		1.00	1.00		1.00
Lane Grp Cap(c), veh/h	289	368	697	433	506	226	1179	2744		149	1235	512
V/C Ratio(X)	0.80	0.77	0.18	0.69	0.79	0.95	0.35	0.41		0.67	0.87	0.32
Avail Cap(c_a), veh/h	356	639	811	518	785	350	1179	2744		173	1630	635
HCM Platoon Ratio	1.00	1.00	1.00	1.00	1.00	1.00	1.00	1.00	1.00	2.00	2.00	2.00
Upstream Filter(I)	1.00	1.00	1.00	1.00	1.00	1.00	1.00	1.00	0.00	0.84	0.84	0.84
Uniform Delay (d), s/veh	54.2	52.8	20.5	50.3	49.7	35.8	29.6	16.5	0.0	54.0	29.3	20.1
Incr Delay (d2), s/veh	8.0	1.3	0.0	2.1	1.3	21.5	0.1	0.5	0.0	4.5	7.5	1.4
Initial Q Delay(d3),s/veh	0.0	0.0	0.0	0.0	0.0	0.0	0.0	0.0	0.0	0.0	0.0	0.0
%ile BackOfQ(50%),veh/ln	3.7	4.1	2.1	4.4	5.8	6.4	4.4	5.9	0.0	1.5	7.1	2.5
Unsig. Movement Delay, s/veh												
LnGrp Delay(d),s/veh	62.2	54.1	20.6	52.4	51.0	57.3	29.7	17.0	0.0	58.5	36.8	21.5
LnGrp LOS	E	D	C	D	D	E	C	B		E	D	C
Approach Vol, veh/h		643			914			1550			1345	
Approach Delay, s/veh		50.3			52.9			20.4			36.6	
Approach LOS		D			D			C			D	
Timer - Assigned Phs	1	2	3	4	5	6	7	8				
Phs Duration (G+Y+Rc), s	46.9	34.7	15.7	22.6	11.2	70.5	21.0	17.3				
Change Period (Y+Rc), s	6.0	5.7	6.0	5.5	6.0	* 6	6.0	5.5				
Max Green Setting (Gmax), s	20.0	38.3	12.0	26.5	6.0	* 52	18.0	20.5				
Max Q Clear Time (g_c+I1), s	12.8	24.7	9.6	15.5	5.4	17.9	12.0	10.9				
Green Ext Time (p_c), s	0.5	4.3	0.1	1.6	0.0	5.5	0.3	0.9				

Intersection Summary

HCM 6th Ctrl Delay	36.3
HCM 6th LOS	D

Notes

- User approved pedestrian interval to be less than phase max green.
- User approved volume balancing among the lanes for turning movement.
- * HCM 6th computational engine requires equal clearance times for the phases crossing the barrier.

Intersection						
Int Delay, s/veh	4					
Movement	EBL	EBT	WBT	WBR	SBL	SBR
Lane Configurations						
Traffic Vol, veh/h	48	81	179	46	34	118
Future Vol, veh/h	48	81	179	46	34	118
Conflicting Peds, #/hr	0	0	0	0	0	0
Sign Control	Free	Free	Free	Free	Stop	Stop
RT Channelized	-	None	-	None	-	None
Storage Length	100	-	-	-	0	-
Veh in Median Storage, #	-	0	0	-	0	-
Grade, %	-	0	0	-	0	-
Peak Hour Factor	91	91	91	91	91	91
Heavy Vehicles, %	2	2	2	2	2	2
Mvmt Flow	53	89	197	51	37	130
Major/Minor	Major1	Major2	Minor2			
Conflicting Flow All	248	0	-	0	418	223
Stage 1	-	-	-	-	223	-
Stage 2	-	-	-	-	195	-
Critical Hdwy	4.12	-	-	-	6.42	6.22
Critical Hdwy Stg 1	-	-	-	-	5.42	-
Critical Hdwy Stg 2	-	-	-	-	5.42	-
Follow-up Hdwy	2.218	-	-	-	3.518	3.318
Pot Cap-1 Maneuver	1318	-	-	-	607	817
Stage 1	-	-	-	-	814	-
Stage 2	-	-	-	-	856	-
Platoon blocked, %		-	-	-	1	
Mov Cap-1 Maneuver	1318	-	-	-	583	817
Mov Cap-2 Maneuver	-	-	-	-	637	-
Stage 1	-	-	-	-	781	-
Stage 2	-	-	-	-	856	-
Approach	EB	WB	SB			
HCM Control Delay, s	2.9	0	11			
HCM LOS			B			
Minor Lane/Major Mvmt	EBL	EBT	WBT	WBR	SBLn1	
Capacity (veh/h)	1318	-	-	-	-	768
HCM Lane V/C Ratio	0.04	-	-	-	-	0.217
HCM Control Delay (s)	7.8	-	-	-	-	11
HCM Lane LOS	A	-	-	-	-	B
HCM 95th %tile Q(veh)	0.1	-	-	-	-	0.8

Intersection						
Int Delay, s/veh	2.9					
Movement	EBT	EBR	WBL	WBT	NBL	NBR
Lane Configurations						
Traffic Vol, veh/h	85	63	33	162	63	39
Future Vol, veh/h	85	63	33	162	63	39
Conflicting Peds, #/hr	0	0	0	0	0	0
Sign Control	Free	Free	Free	Free	Stop	Stop
RT Channelized	-	None	-	None	-	None
Storage Length	-	-	100	-	80	0
Veh in Median Storage, #	0	-	-	0	0	-
Grade, %	0	-	-	0	0	-
Peak Hour Factor	89	89	89	89	89	89
Heavy Vehicles, %	2	2	2	2	2	2
Mvmt Flow	96	71	37	182	71	44

Major/Minor	Major1	Major2	Minor1		
Conflicting Flow All	0	0	167	0	388
Stage 1	-	-	-	-	132
Stage 2	-	-	-	-	256
Critical Hdwy	-	-	4.12	-	6.42
Critical Hdwy Stg 1	-	-	-	-	5.42
Critical Hdwy Stg 2	-	-	-	-	5.42
Follow-up Hdwy	-	-	2.218	-	3.518
Pot Cap-1 Maneuver	-	-	1423	-	633
Stage 1	-	-	-	-	916
Stage 2	-	-	-	-	787
Platoon blocked, %	-	-	1	-	1
Mov Cap-1 Maneuver	-	-	1423	-	617
Mov Cap-2 Maneuver	-	-	-	-	654
Stage 1	-	-	-	-	916
Stage 2	-	-	-	-	767

Approach	EB	WB	NB
HCM Control Delay, s	0	1.3	10.3
HCM LOS			B

Minor Lane/Major Mvmt	NBLn1	NBLn2	EBT	EBR	WBL	WBT
Capacity (veh/h)	654	958	-	-	1423	-
HCM Lane V/C Ratio	0.108	0.046	-	-	0.026	-
HCM Control Delay (s)	11.2	8.9	-	-	7.6	-
HCM Lane LOS	B	A	-	-	A	-
HCM 95th %tile Q(veh)	0.4	0.1	-	-	0.1	-

Intersection						
Int Delay, s/veh	2					
Movement	WBL	WBR	NBT	NBR	SBL	SBT
Lane Configurations						
Traffic Vol, veh/h	21	21	76	6	1	69
Future Vol, veh/h	21	21	76	6	1	69
Conflicting Peds, #/hr	0	0	0	0	0	0
Sign Control	Stop	Stop	Free	Free	Free	Free
RT Channelized	-	None	-	None	-	None
Storage Length	75	0	-	-	100	-
Veh in Median Storage, #	0	-	0	-	-	0
Grade, %	0	-	0	-	-	0
Peak Hour Factor	92	92	92	92	92	92
Heavy Vehicles, %	2	2	2	2	2	2
Mvmt Flow	23	23	83	7	1	75

Major/Minor	Minor1	Major1	Major2		
Conflicting Flow All	164	87	0	0	90
Stage 1	87	-	-	-	-
Stage 2	77	-	-	-	-
Critical Hdwy	6.42	6.22	-	-	4.12
Critical Hdwy Stg 1	5.42	-	-	-	-
Critical Hdwy Stg 2	5.42	-	-	-	-
Follow-up Hdwy	3.518	3.318	-	-	2.218
Pot Cap-1 Maneuver	827	971	-	-	1505
Stage 1	936	-	-	-	-
Stage 2	946	-	-	-	-
Platoon blocked, %			-	-	-
Mov Cap-1 Maneuver	826	971	-	-	1505
Mov Cap-2 Maneuver	806	-	-	-	-
Stage 1	936	-	-	-	-
Stage 2	945	-	-	-	-

Approach	WB	NB	SB
HCM Control Delay, s	9.2	0	0.1
HCM LOS	A		

Minor Lane/Major Mvmt	NBT	NBRWBLn1	WBLn2	SBL	SBT
Capacity (veh/h)	-	-	806	971	1505
HCM Lane V/C Ratio	-	-	0.028	0.024	0.001
HCM Control Delay (s)	-	-	9.6	8.8	7.4
HCM Lane LOS	-	-	A	A	A
HCM 95th %tile Q(veh)	-	-	0.1	0.1	0

Intersection												
Int Delay, s/veh	0.5											
Movement	EBL	EBT	EBR	WBL	WBT	WBR	NBL	NBT	NBR	SBL	SBT	SBR
Lane Configurations		↕			↕		↕	↕		↕	↕	
Traffic Vol, veh/h	4	1	0	0	0	2	1	77	2	2	86	4
Future Vol, veh/h	4	1	0	0	0	2	1	77	2	2	86	4
Conflicting Peds, #/hr	0	0	0	0	0	0	0	0	0	0	0	0
Sign Control	Stop	Stop	Stop	Stop	Stop	Stop	Free	Free	Free	Free	Free	Free
RT Channelized	-	-	None	-	-	None	-	-	None	-	-	None
Storage Length	-	-	-	-	-	-	100	-	-	100	-	-
Veh in Median Storage, #	-	0	-	-	0	-	-	0	-	-	0	-
Grade, %	-	0	-	-	0	-	-	0	-	-	0	-
Peak Hour Factor	92	92	92	92	92	92	92	92	92	92	92	92
Heavy Vehicles, %	2	2	2	2	2	2	2	2	2	2	2	2
Mvmt Flow	4	1	0	0	0	2	1	84	2	2	93	4

Major/Minor	Minor2		Minor1		Major1			Major2				
Conflicting Flow All	187	187	95	187	188	85	97	0	0	86	0	0
Stage 1	99	99	-	87	87	-	-	-	-	-	-	-
Stage 2	88	88	-	100	101	-	-	-	-	-	-	-
Critical Hdwy	7.12	6.52	6.22	7.12	6.52	6.22	4.12	-	-	4.12	-	-
Critical Hdwy Stg 1	6.12	5.52	-	6.12	5.52	-	-	-	-	-	-	-
Critical Hdwy Stg 2	6.12	5.52	-	6.12	5.52	-	-	-	-	-	-	-
Follow-up Hdwy	3.518	4.018	3.318	3.518	4.018	3.318	2.218	-	-	2.218	-	-
Pot Cap-1 Maneuver	774	708	962	774	707	974	1496	-	-	1510	-	-
Stage 1	907	813	-	921	823	-	-	-	-	-	-	-
Stage 2	920	822	-	906	811	-	-	-	-	-	-	-
Platoon blocked, %								-	-	-	-	-
Mov Cap-1 Maneuver	771	707	962	772	706	974	1496	-	-	1510	-	-
Mov Cap-2 Maneuver	771	707	-	772	706	-	-	-	-	-	-	-
Stage 1	906	812	-	920	822	-	-	-	-	-	-	-
Stage 2	917	821	-	904	810	-	-	-	-	-	-	-

Approach	EB		WB		NB		SB	
HCM Control Delay, s	9.8		8.7		0.1		0.2	
HCM LOS	A		A					

Minor Lane/Major Mvmt	NBL	NBT	NBR	EBLn1WBLn1	SBL	SBT	SBR
Capacity (veh/h)	1496	-	-	757	974	1510	-
HCM Lane V/C Ratio	0.001	-	-	0.007	0.002	0.001	-
HCM Control Delay (s)	7.4	-	-	9.8	8.7	7.4	-
HCM Lane LOS	A	-	-	A	A	A	-
HCM 95th %tile Q(veh)	0	-	-	0	0	0	-

Intersection												
Int Delay, s/veh	1.8											
Movement	EBL	EBT	EBR	WBL	WBT	WBR	NBL	NBT	NBR	SBL	SBT	SBR
Lane Configurations	↖	↗		↖	↗			↕			↕	
Traffic Vol, veh/h	19	106	10	15	130	3	7	0	15	3	0	7
Future Vol, veh/h	19	106	10	15	130	3	7	0	15	3	0	7
Conflicting Peds, #/hr	0	0	0	0	0	0	0	0	0	0	0	0
Sign Control	Free	Free	Free	Free	Free	Free	Stop	Stop	Stop	Stop	Stop	Stop
RT Channelized	-	-	None	-	-	None	-	-	None	-	-	None
Storage Length	100	-	-	100	-	-	-	-	-	-	-	-
Veh in Median Storage, #	-	0	-	-	0	-	-	0	-	-	0	-
Grade, %	-	0	-	-	0	-	-	0	-	-	0	-
Peak Hour Factor	90	90	90	90	90	90	90	90	90	90	90	90
Heavy Vehicles, %	2	2	2	2	2	2	2	2	2	2	2	2
Mvmt Flow	21	118	11	17	144	3	8	0	17	3	0	8

Major/Minor	Major1			Major2			Minor1			Minor2		
Conflicting Flow All	147	0	0	129	0	0	350	347	124	354	351	146
Stage 1	-	-	-	-	-	-	166	166	-	180	180	-
Stage 2	-	-	-	-	-	-	184	181	-	174	171	-
Critical Hdwy	4.12	-	-	4.12	-	-	7.12	6.52	6.22	7.12	6.52	6.22
Critical Hdwy Stg 1	-	-	-	-	-	-	6.12	5.52	-	6.12	5.52	-
Critical Hdwy Stg 2	-	-	-	-	-	-	6.12	5.52	-	6.12	5.52	-
Follow-up Hdwy	2.218	-	-	2.218	-	-	3.518	4.018	3.318	3.518	4.018	3.318
Pot Cap-1 Maneuver	1435	-	-	1457	-	-	605	576	927	601	573	901
Stage 1	-	-	-	-	-	-	836	761	-	822	750	-
Stage 2	-	-	-	-	-	-	818	750	-	828	757	-
Platoon blocked, %	-	-	-	-	-	-	-	-	-	-	-	-
Mov Cap-1 Maneuver	1435	-	-	1457	-	-	588	560	927	578	558	901
Mov Cap-2 Maneuver	-	-	-	-	-	-	588	560	-	578	558	-
Stage 1	-	-	-	-	-	-	823	750	-	810	741	-
Stage 2	-	-	-	-	-	-	801	741	-	801	746	-

Approach	EB			WB			NB			SB		
HCM Control Delay, s	1.1			0.8			9.7			9.7		
HCM LOS							A			A		

Minor Lane/Major Mvmt	NBLn1	EBL	EBT	EBR	WBL	WBT	WBR	SBLn1
Capacity (veh/h)	783	1435	-	-	1457	-	-	772
HCM Lane V/C Ratio	0.031	0.015	-	-	0.011	-	-	0.014
HCM Control Delay (s)	9.7	7.5	-	-	7.5	-	-	9.7
HCM Lane LOS	A	A	-	-	A	-	-	A
HCM 95th %tile Q(veh)	0.1	0	-	-	0	-	-	0

Intersection	
Intersection Delay, s/veh	8.7
Intersection LOS	A

Movement	EBL	EBT	EBR	WBL	WBT	WBR	NBL	NBT	NBR	SBL	SBT	SBR
Lane Configurations	↶	↷		↶	↷		↶	↷		↶	↷	
Traffic Vol, veh/h	17	46	38	35	54	3	46	58	15	7	58	26
Future Vol, veh/h	17	46	38	35	54	3	46	58	15	7	58	26
Peak Hour Factor	0.84	0.84	0.84	0.84	0.84	0.84	0.84	0.84	0.84	0.84	0.84	0.84
Heavy Vehicles, %	2	2	2	2	2	2	2	2	2	2	2	2
Mvmt Flow	20	55	45	42	64	4	55	69	18	8	69	31
Number of Lanes	1	1	0	1	1	0	1	1	0	1	1	0

Approach	EB	WB	NB	SB
Opposing Approach	WB	EB	SB	NB
Opposing Lanes	2	2	2	2
Conflicting Approach Left	SB	NB	EB	WB
Conflicting Lanes Left	2	2	2	2
Conflicting Approach Right	NB	SB	WB	EB
Conflicting Lanes Right	2	2	2	2
HCM Control Delay	8.5	8.8	8.7	8.6
HCM LOS	A	A	A	A

Lane	NBLn1	NBLn2	EBLn1	EBLn2	WBLn1	WBLn2	SBLn1	SBLn2
Vol Left, %	100%	0%	100%	0%	100%	0%	100%	0%
Vol Thru, %	0%	79%	0%	55%	0%	95%	0%	69%
Vol Right, %	0%	21%	0%	45%	0%	5%	0%	31%
Sign Control	Stop	Stop	Stop	Stop	Stop	Stop	Stop	Stop
Traffic Vol by Lane	46	73	17	84	35	57	7	84
LT Vol	46	0	17	0	35	0	7	0
Through Vol	0	58	0	46	0	54	0	58
RT Vol	0	15	0	38	0	3	0	26
Lane Flow Rate	55	87	20	100	42	68	8	100
Geometry Grp	7	7	7	7	7	7	7	7
Degree of Util (X)	0.087	0.123	0.033	0.138	0.067	0.099	0.013	0.141
Departure Headway (Hd)	5.737	5.09	5.796	4.975	5.799	5.259	5.78	5.059
Convergence, Y/N	Yes	Yes	Yes	Yes	Yes	Yes	Yes	Yes
Cap	624	703	617	719	617	680	619	708
Service Time	3.475	2.828	3.536	2.715	3.54	3	3.52	2.799
HCM Lane V/C Ratio	0.088	0.124	0.032	0.139	0.068	0.1	0.013	0.141
HCM Control Delay	9	8.5	8.7	8.5	9	8.6	8.6	8.6
HCM Lane LOS	A	A	A	A	A	A	A	A
HCM 95th-tile Q	0.3	0.4	0.1	0.5	0.2	0.3	0	0.5

15: 73rd Street/Dial Boulevard & Greenway Hayden Loop

08/18/2022

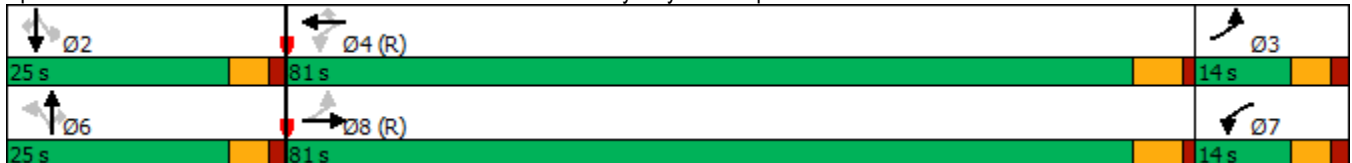


Lane Group	EBL	EBT	WBL	WBT	WBR	NBL	NBT	NBR	SBL	SBT	SBR
Lane Configurations											
Traffic Volume (vph)	81	450	169	645	37	87	76	314	42	66	86
Future Volume (vph)	81	450	169	645	37	87	76	314	42	66	86
Turn Type	pm+pt	NA	pm+pt	NA	Perm	Perm	NA	Perm	Perm	NA	Perm
Protected Phases	3	8	7	4			6			2	
Permitted Phases	8		4		4	6		6	2		2
Detector Phase	3	8	7	4	4	6	6	6	2	2	2
Switch Phase											
Minimum Initial (s)	5.0	10.0	5.0	10.0	10.0	7.0	7.0	7.0	7.0	7.0	7.0
Minimum Split (s)	12.0	37.0	37.0	36.0	36.0	37.0	37.0	37.0	37.0	37.0	37.0
Total Split (s)	14.0	81.0	14.0	81.0	81.0	25.0	25.0	25.0	25.0	25.0	25.0
Total Split (%)	11.7%	67.5%	11.7%	67.5%	67.5%	20.8%	20.8%	20.8%	20.8%	20.8%	20.8%
Yellow Time (s)	3.6	4.4	3.6	4.4	4.4	3.6	3.6	3.6	3.6	3.6	3.6
All-Red Time (s)	1.7	1.0	1.7	1.0	1.0	1.6	1.6	1.6	1.6	1.6	1.6
Lost Time Adjust (s)	0.0	0.0	0.0	0.0	0.0	0.0	0.0	0.0	0.0	0.0	0.0
Total Lost Time (s)	5.3	5.4	5.3	5.4	5.4	5.2	5.2	5.2	5.2	5.2	5.2
Lead/Lag	Lag	Lead	Lag	Lead	Lead						
Lead-Lag Optimize?	Yes	Yes	Yes	Yes	Yes						
Recall Mode	None	C-Min	None	C-Min	C-Min	None	None	None	None	None	None
Act Effct Green (s)	85.4	79.6	94.0	84.4	84.4	14.0	14.0	14.0	14.0	14.0	14.0
Actuated g/C Ratio	0.71	0.66	0.78	0.70	0.70	0.12	0.12	0.12	0.12	0.12	0.12
v/c Ratio	0.18	0.17	0.28	0.30	0.04	0.66	0.41	0.72	0.33	0.35	0.37
Control Delay	7.5	7.2	6.3	13.7	5.9	69.4	52.9	13.3	52.2	51.4	12.3
Queue Delay	0.0	0.0	0.0	0.0	0.0	0.0	0.0	0.0	0.0	0.0	0.0
Total Delay	7.5	7.2	6.3	13.7	5.9	69.4	52.9	13.3	52.2	51.4	12.3
LOS	A	A	A	B	A	E	D	B	D	D	B
Approach Delay		7.2		11.9			29.8			34.3	
Approach LOS		A		B			C			C	

Intersection Summary

Cycle Length: 120
 Actuated Cycle Length: 120
 Offset: 111 (93%), Referenced to phase 4:WBTL and 8:EBTL, Start of Green
 Natural Cycle: 115
 Control Type: Actuated-Coordinated
 Maximum v/c Ratio: 0.72
 Intersection Signal Delay: 16.7
 Intersection LOS: B
 Intersection Capacity Utilization 48.3%
 ICU Level of Service A
 Analysis Period (min) 15

Splits and Phases: 15: 73rd Street/Dial Boulevard & Greenway Hayden Loop



15: 73rd Street/Dial Boulevard & Greenway Hayden Loop

08/18/2022



Movement	EBL	EBT	EBR	WBL	WBT	WBR	NBL	NBT	NBR	SBL	SBT	SBR
Lane Configurations	↖	↕↕↕		↖	↕↕	↖	↖	↕	↖	↖	↕	↖
Traffic Volume (veh/h)	81	450	50	169	645	37	87	76	314	42	66	86
Future Volume (veh/h)	81	450	50	169	645	37	87	76	314	42	66	86
Initial Q (Qb), veh	0	0	0	0	0	0	0	0	0	0	0	0
Ped-Bike Adj(A_pbT)	1.00		1.00	1.00		1.00	1.00		1.00	1.00		1.00
Parking Bus, Adj	1.00	1.00	1.00	1.00	1.00	1.00	1.00	1.00	1.00	1.00	1.00	1.00
Work Zone On Approach		No			No			No			No	
Adj Sat Flow, veh/h/ln	1870	1870	1870	1870	1870	1870	1870	1870	1870	1870	1870	1870
Adj Flow Rate, veh/h	94	523	58	197	750	43	101	88	365	49	77	100
Peak Hour Factor	0.86	0.86	0.86	0.86	0.86	0.86	0.86	0.86	0.86	0.86	0.86	0.86
Percent Heavy Veh, %	2	2	2	2	2	2	2	2	2	2	2	2
Cap, veh/h	865	698	76	1064	890	397	216	309	262	176	309	262
Arrive On Green	0.30	0.10	0.10	0.55	0.25	0.25	0.17	0.17	0.17	0.17	0.17	0.17
Sat Flow, veh/h	1781	4671	511	1781	3554	1585	1207	1870	1585	938	1870	1585
Grp Volume(v), veh/h	94	379	202	197	750	43	101	88	365	49	77	100
Grp Sat Flow(s),veh/h/ln	1781	1702	1778	1781	1777	1585	1207	1870	1585	938	1870	1585
Q Serve(g_s), s	0.4	13.0	13.3	0.7	24.1	2.5	9.5	4.9	19.8	5.8	4.3	6.7
Cycle Q Clear(g_c), s	0.4	13.0	13.3	0.7	24.1	2.5	13.8	4.9	19.8	10.7	4.3	6.7
Prop In Lane	1.00		0.29	1.00		1.00	1.00		1.00	1.00		1.00
Lane Grp Cap(c), veh/h	865	509	266	1064	890	397	216	309	262	176	309	262
V/C Ratio(X)	0.11	0.75	0.76	0.19	0.84	0.11	0.47	0.29	1.40	0.28	0.25	0.38
Avail Cap(c_a), veh/h	865	2145	1120	1064	2239	999	216	309	262	176	309	262
HCM Platoon Ratio	0.67	0.67	0.67	1.00	1.00	1.00	1.00	1.00	1.00	1.00	1.00	1.00
Upstream Filter(I)	0.85	0.85	0.85	1.00	1.00	1.00	1.00	1.00	1.00	1.00	1.00	1.00
Uniform Delay (d), s/veh	22.9	51.8	51.9	11.9	42.7	34.7	49.7	43.9	50.1	48.6	43.6	44.7
Incr Delay (d2), s/veh	0.0	8.2	15.8	0.0	9.6	0.6	0.6	0.2	199.7	0.3	0.2	0.3
Initial Q Delay(d3),s/veh	0.0	0.0	0.0	0.0	0.0	0.0	0.0	0.0	0.0	0.0	0.0	0.0
%ile BackOfQ(50%),veh/ln	1.8	6.3	7.3	2.4	11.7	1.0	2.9	2.3	22.3	1.4	2.0	2.7
Unsig. Movement Delay, s/veh												
LnGrp Delay(d),s/veh	22.9	60.0	67.7	11.9	52.3	35.2	50.2	44.1	249.8	48.9	43.8	45.0
LnGrp LOS	C	E	E	B	D	D	D	D	F	D	D	D
Approach Vol, veh/h		675			990			554			226	
Approach Delay, s/veh		57.1			43.5			180.7			45.4	
Approach LOS		E			D			F			D	
Timer - Assigned Phs		2	3	4		6	7	8				
Phs Duration (G+Y+Rc), s		25.0	59.6	35.4		25.0	71.7	23.3				
Change Period (Y+Rc), s		* 5.2	5.3	* 5.4		* 5.2	5.3	* 5.4				
Max Green Setting (Gmax), s		* 20	8.7	* 76		* 20	8.7	* 76				
Max Q Clear Time (g_c+I1), s		12.7	2.4	26.1		21.8	2.7	15.3				
Green Ext Time (p_c), s		0.3	0.0	4.0		0.0	0.1	2.7				

Intersection Summary

HCM 6th Ctrl Delay	78.5
HCM 6th LOS	E

Notes

User approved pedestrian interval to be less than phase max green.
 * HCM 6th computational engine requires equal clearance times for the phases crossing the barrier.

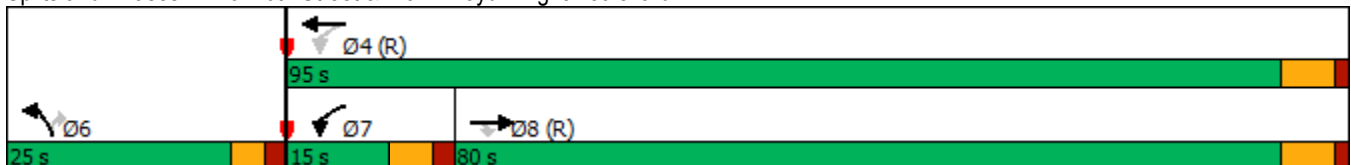


Lane Group	EBT	EBR	WBL	WBT	NBL	NBR
Lane Configurations	↑↑↑	↑	↓	↑↑↑	↓	↓
Traffic Volume (vph)	1050	85	184	1379	133	261
Future Volume (vph)	1050	85	184	1379	133	261
Turn Type	NA	Perm	pm+pt	NA	Prot	Perm
Protected Phases	8		7	4	6	
Permitted Phases		8	4			6
Detector Phase	8	8	7	4	6	6
Switch Phase						
Minimum Initial (s)	7.0	7.0	5.0	10.0	7.0	7.0
Minimum Split (s)	13.2	13.2	11.0	16.2	12.0	12.0
Total Split (s)	80.0	80.0	15.0	95.0	25.0	25.0
Total Split (%)	66.7%	66.7%	12.5%	79.2%	20.8%	20.8%
Yellow Time (s)	4.7	4.7	4.0	4.7	3.0	3.0
All-Red Time (s)	1.5	1.5	1.9	1.5	2.0	2.0
Lost Time Adjust (s)	0.0	0.0	0.0	0.0	0.0	0.0
Total Lost Time (s)	6.2	6.2	5.9	6.2	5.0	5.0
Lead/Lag	Lag	Lag	Lead			
Lead-Lag Optimize?	Yes	Yes	Yes			
Recall Mode	C-Min	C-Min	None	C-Min	None	None
Act Effct Green (s)	83.9	83.9	96.4	96.1	12.7	12.7
Actuated g/C Ratio	0.70	0.70	0.80	0.80	0.11	0.11
v/c Ratio	0.32	0.08	0.52	0.37	0.40	0.81
Control Delay	14.0	5.9	10.3	2.1	51.8	33.9
Queue Delay	0.0	0.0	0.0	0.0	0.0	0.0
Total Delay	14.0	5.9	10.3	2.1	51.8	33.9
LOS	B	A	B	A	D	C
Approach Delay	13.4			3.0	40.0	
Approach LOS	B			A	D	

Intersection Summary

Cycle Length: 120
 Actuated Cycle Length: 120
 Offset: 44 (37%), Referenced to phase 4:WBTL and 8:EBT, Start of 1st Green
 Natural Cycle: 45
 Control Type: Actuated-Coordinated
 Maximum v/c Ratio: 0.81
 Intersection Signal Delay: 11.6
 Intersection Capacity Utilization 50.6%
 Analysis Period (min) 15
 Intersection LOS: B
 ICU Level of Service A

Splits and Phases: 16: 76th Street & Frank Lloyd Wright Boulevard





Movement	EBT	EBR	WBL	WBT	NBL	NBR	
Lane Configurations	↑↑↑	↑	↓	↑↑↑	↓	↑	
Traffic Volume (veh/h)	1050	85	184	1379	133	261	
Future Volume (veh/h)	1050	85	184	1379	133	261	
Initial Q (Qb), veh	0	0	0	0	0	0	
Ped-Bike Adj(A_pbT)		1.00	1.00		1.00	1.00	
Parking Bus, Adj	1.00	1.00	1.00	1.00	1.00	1.00	
Work Zone On Approach	No			No	No		
Adj Sat Flow, veh/h/ln	1870	1870	1870	1870	1870	1870	
Adj Flow Rate, veh/h	1141	92	200	1499	145	284	
Peak Hour Factor	0.92	0.92	0.92	0.92	0.92	0.92	
Percent Heavy Veh, %	2	2	2	2	2	2	
Cap, veh/h	3239	1005	447	3779	576	264	
Arrive On Green	1.00	1.00	0.11	1.00	0.17	0.17	
Sat Flow, veh/h	5274	1585	1781	5274	3456	1585	
Grp Volume(v), veh/h	1141	92	200	1499	145	284	
Grp Sat Flow(s),veh/h/ln	1702	1585	1781	1702	1728	1585	
Q Serve(g_s), s	0.0	0.0	4.8	0.0	4.4	20.0	
Cycle Q Clear(g_c), s	0.0	0.0	4.8	0.0	4.4	20.0	
Prop In Lane		1.00	1.00		1.00	1.00	
Lane Grp Cap(c), veh/h	3239	1005	447	3779	576	264	
V/C Ratio(X)	0.35	0.09	0.45	0.40	0.25	1.08	
Avail Cap(c_a), veh/h	3239	1005	482	3779	576	264	
HCM Platoon Ratio	2.00	2.00	2.00	2.00	1.00	1.00	
Upstream Filter(I)	0.85	0.85	0.78	0.78	1.00	1.00	
Uniform Delay (d), s/veh	0.0	0.0	5.5	0.0	43.5	50.0	
Incr Delay (d2), s/veh	0.3	0.2	0.2	0.2	0.1	76.7	
Initial Q Delay(d3),s/veh	0.0	0.0	0.0	0.0	0.0	0.0	
%ile BackOfQ(50%),veh/ln	0.1	0.0	1.3	0.1	1.9	21.8	
Unsig. Movement Delay, s/veh							
LnGrp Delay(d),s/veh	0.3	0.2	5.7	0.2	43.6	126.7	
LnGrp LOS	A	A	A	A	D	F	
Approach Vol, veh/h	1233			1699	429		
Approach Delay, s/veh	0.2			0.9	98.6		
Approach LOS	A			A	F		
Timer - Assigned Phs				4	6	7	8
Phs Duration (G+Y+Rc), s				95.0	25.0	12.7	82.3
Change Period (Y+Rc), s				6.2	5.0	* 5.9	6.2
Max Green Setting (Gmax), s				88.8	20.0	* 9.1	73.8
Max Q Clear Time (g_c+I1), s				2.0	22.0	6.8	2.0
Green Ext Time (p_c), s				2.0	0.0	0.0	1.4

Intersection Summary

HCM 6th Ctrl Delay	13.1
HCM 6th LOS	B

Notes

User approved pedestrian interval to be less than phase max green.
 * HCM 6th computational engine requires equal clearance times for the phases crossing the barrier.

Intersection

Intersection Delay, s/veh 9.9

Intersection LOS A

Movement	EBL	EBT	EBR	WBL	WBT	WBR	NBL	NBT	NBR	SBL	SBT	SBR
Lane Configurations												
Traffic Vol, veh/h	69	38	10	6	93	51	15	129	15	13	68	33
Future Vol, veh/h	69	38	10	6	93	51	15	129	15	13	68	33
Peak Hour Factor	0.80	0.80	0.80	0.80	0.80	0.80	0.80	0.80	0.80	0.80	0.80	0.80
Heavy Vehicles, %	2	2	2	2	2	2	2	2	2	2	2	2
Mvmt Flow	86	48	13	8	116	64	19	161	19	16	85	41
Number of Lanes	1	1	0	1	1	0	1	1	0	1	1	0

Approach	EB	WB	NB	SB
Opposing Approach	WB	EB	SB	NB
Opposing Lanes	2	2	2	2
Conflicting Approach Left	SB	NB	EB	WB
Conflicting Lanes Left	2	2	2	2
Conflicting Approach Right	NB	SB	WB	EB
Conflicting Lanes Right	2	2	2	2
HCM Control Delay	9.5	10.1	10.3	9.5
HCM LOS	A	B	B	A

Lane	NBLn1	NBLn2	EBLn1	EBLn2	WBLn1	WBLn2	SBLn1	SBLn2
Vol Left, %	100%	0%	100%	0%	100%	0%	100%	0%
Vol Thru, %	0%	90%	0%	79%	0%	65%	0%	67%
Vol Right, %	0%	10%	0%	21%	0%	35%	0%	33%
Sign Control	Stop	Stop	Stop	Stop	Stop	Stop	Stop	Stop
Traffic Vol by Lane	15	144	69	48	6	144	13	101
LT Vol	15	0	69	0	6	0	13	0
Through Vol	0	129	0	38	0	93	0	68
RT Vol	0	15	0	10	0	51	0	33
Lane Flow Rate	19	180	86	60	8	180	16	126
Geometry Grp	7	7	7	7	7	7	7	7
Degree of Util (X)	0.032	0.276	0.147	0.092	0.013	0.268	0.028	0.19
Departure Headway (Hd)	6.09	5.512	6.156	5.504	6.122	5.368	6.164	5.429
Convergence, Y/N	Yes	Yes	Yes	Yes	Yes	Yes	Yes	Yes
Cap	583	646	577	644	580	662	575	654
Service Time	3.878	3.3	3.953	3.301	3.912	3.157	3.96	3.224
HCM Lane V/C Ratio	0.033	0.279	0.149	0.093	0.014	0.272	0.028	0.193
HCM Control Delay	9.1	10.4	10	8.9	9	10.1	9.1	9.5
HCM Lane LOS	A	B	A	A	A	B	A	A
HCM 95th-tile Q	0.1	1.1	0.5	0.3	0	1.1	0.1	0.7

18: Greenway Hayden Loop & Frank Lloyd Wright Boulevard

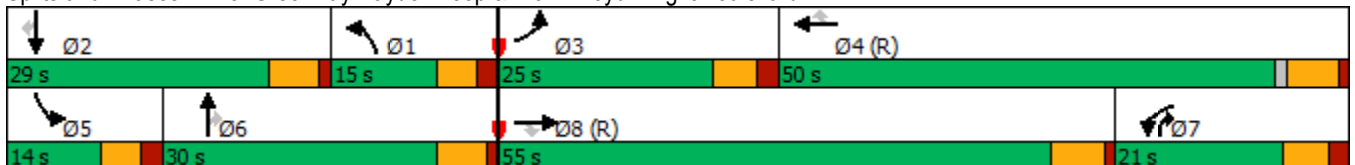
08/18/2022

Lane Group	EBL	EBT	EBR	WBL	WBT	WBR	NBL	NBT	NBR	SBL	SBT	SBR
Lane Configurations												
Traffic Volume (vph)	349	1125	39	384	1180	317	46	490	561	137	396	329
Future Volume (vph)	349	1125	39	384	1180	317	46	490	561	137	396	329
Turn Type	Prot	NA	Perm	Prot	NA	Perm	Prot	NA	pm+ov	Prot	NA	Perm
Protected Phases	3	8		7	4		1	6	7	5	2	
Permitted Phases			8			4			6			2
Detector Phase	3	8	8	7	4	4	1	6	7	5	2	2
Switch Phase												
Minimum Initial (s)	5.0	10.0	10.0	5.0	10.0	10.0	5.0	7.0	5.0	5.0	7.0	7.0
Minimum Split (s)	11.0	15.9	15.9	11.0	15.9	15.9	11.0	13.0	11.0	11.0	13.0	13.0
Total Split (s)	25.0	55.0	55.0	21.0	50.0	50.0	15.0	30.0	21.0	14.0	29.0	29.0
Total Split (%)	20.8%	45.8%	45.8%	17.5%	41.7%	41.7%	12.5%	25.0%	17.5%	11.7%	24.2%	24.2%
Yellow Time (s)	4.0	4.7	4.7	4.0	4.7	4.7	3.6	4.4	4.0	3.6	4.4	4.4
All-Red Time (s)	2.0	1.0	1.0	2.0	1.0	1.0	2.0	1.2	2.0	2.0	1.2	1.2
Lost Time Adjust (s)	0.0	0.0	0.0	0.0	0.0	0.0	0.0	0.0	0.0	0.0	0.0	0.0
Total Lost Time (s)	6.0	5.7	5.7	6.0	5.7	5.7	5.6	5.6	6.0	5.6	5.6	5.6
Lead/Lag	Lead	Lead	Lead	Lag	Lag	Lag	Lag	Lag	Lag	Lead	Lead	Lead
Lead-Lag Optimize?	Yes	Yes	Yes	Yes	Yes	Yes	Yes	Yes	Yes	Yes	Yes	Yes
Recall Mode	None	C-Min	C-Min	None	C-Min	C-Min	None	None	None	None	None	None
Act Effct Green (s)	16.1	36.5	36.5	31.6	51.9	51.9	10.0	21.0	52.2	8.0	21.1	21.1
Actuated g/C Ratio	0.13	0.30	0.30	0.26	0.43	0.43	0.08	0.18	0.44	0.07	0.18	0.18
v/c Ratio	0.82	0.79	0.07	0.46	0.58	0.42	0.34	0.86	0.80	0.65	0.69	0.62
Control Delay	54.5	23.7	0.2	40.5	28.2	10.3	64.3	68.4	28.1	68.1	53.2	9.6
Queue Delay	0.0	0.0	0.0	0.0	0.0	0.0	0.0	0.0	0.0	0.0	0.0	0.0
Total Delay	54.5	23.7	0.2	40.5	28.2	10.3	64.3	68.4	28.1	68.1	53.2	9.6
LOS	D	C	A	D	C	B	E	E	C	E	D	A
Approach Delay		30.2			27.7			47.6			38.9	
Approach LOS		C			C			D			D	

Intersection Summary

Cycle Length: 120
 Actuated Cycle Length: 120
 Offset: 38 (32%), Referenced to phase 4:WBT and 8:EBT, Start of 1st Green
 Natural Cycle: 80
 Control Type: Actuated-Coordinated
 Maximum v/c Ratio: 0.86
 Intersection Signal Delay: 34.3
 Intersection Capacity Utilization 75.1%
 Analysis Period (min) 15
 Intersection LOS: C
 ICU Level of Service D

Splits and Phases: 18: Greenway Hayden Loop & Frank Lloyd Wright Boulevard



18: Greenway Hayden Loop & Frank Lloyd Wright Boulevard

08/18/2022



Movement	EBL	EBT	EBR	WBL	WBT	WBR	NBL	NBT	NBR	SBL	SBT	SBR
Lane Configurations												
Traffic Volume (veh/h)	349	1125	39	384	1180	317	46	490	561	137	396	329
Future Volume (veh/h)	349	1125	39	384	1180	317	46	490	561	137	396	329
Initial Q (Qb), veh	0	0	0	0	0	0	0	0	0	0	0	0
Ped-Bike Adj(A_pbT)	1.00		1.00	1.00		1.00	1.00		1.00	1.00		1.00
Parking Bus, Adj	1.00	1.00	1.00	1.00	1.00	1.00	1.00	1.00	1.00	1.00	1.00	1.00
Work Zone On Approach		No			No			No			No	
Adj Sat Flow, veh/h/ln	1870	1870	1870	1870	1870	1870	1870	1870	1870	1870	1870	1870
Adj Flow Rate, veh/h	379	1223	42	417	1283	345	50	533	610	149	430	358
Peak Hour Factor	0.92	0.92	0.92	0.92	0.92	0.92	0.92	0.92	0.92	0.92	0.92	0.92
Percent Heavy Veh, %	2	2	2	2	2	2	2	2	2	2	2	2
Cap, veh/h	438	1419	441	1041	2297	713	157	608	749	204	504	225
Arrive On Green	0.04	0.09	0.09	0.30	0.45	0.45	0.09	0.17	0.17	0.06	0.14	0.14
Sat Flow, veh/h	3456	5106	1585	3456	5106	1585	1781	3554	1585	3456	3554	1585
Grp Volume(v), veh/h	379	1223	42	417	1283	345	50	533	610	149	430	358
Grp Sat Flow(s),veh/h/ln	1728	1702	1585	1728	1702	1585	1781	1777	1585	1728	1777	1585
Q Serve(g_s), s	13.1	28.3	2.9	11.5	22.2	18.4	3.2	17.6	7.9	5.1	14.2	12.6
Cycle Q Clear(g_c), s	13.1	28.3	2.9	11.5	22.2	18.4	3.2	17.6	7.9	5.1	14.2	12.6
Prop In Lane	1.00		1.00	1.00		1.00	1.00		1.00	1.00		1.00
Lane Grp Cap(c), veh/h	438	1419	441	1041	2297	713	157	608	749	204	504	225
V/C Ratio(X)	0.87	0.86	0.10	0.40	0.56	0.48	0.32	0.88	0.81	0.73	0.85	1.59
Avail Cap(c_a), veh/h	547	2098	651	1041	2297	713	157	723	800	242	693	309
HCM Platoon Ratio	0.33	0.33	0.33	1.00	1.00	1.00	1.00	1.00	1.00	1.00	1.00	1.00
Upstream Filter(I)	0.91	0.91	0.91	1.00	1.00	1.00	1.00	1.00	1.00	1.00	1.00	1.00
Uniform Delay (d), s/veh	56.5	52.2	40.7	33.3	24.2	23.2	51.3	48.5	11.4	55.5	50.3	28.2
Incr Delay (d2), s/veh	9.1	6.5	0.4	0.1	1.0	2.3	0.4	9.3	5.6	6.7	5.8	286.9
Initial Q Delay(d3),s/veh	0.0	0.0	0.0	0.0	0.0	0.0	0.0	0.0	0.0	0.0	0.0	0.0
%ile BackOfQ(50%),veh/ln	6.6	13.7	1.2	4.7	8.7	7.0	1.4	8.4	8.4	2.4	6.6	22.5
Unsig. Movement Delay, s/veh												
LnGrp Delay(d),s/veh	65.5	58.7	41.1	33.4	25.2	25.5	51.8	57.8	17.0	62.2	56.0	315.0
LnGrp LOS	E	E	D	C	C	C	D	E	B	E	E	F
Approach Vol, veh/h		1644			2045			1193			937	
Approach Delay, s/veh		59.9			27.0			36.7			156.0	
Approach LOS		E			C			D			F	
Timer - Assigned Phs	1	2	3	4	5	6	7	8				
Phs Duration (G+Y+Rc), s	16.2	22.6	21.2	60.0	12.7	26.1	42.2	39.0				
Change Period (Y+Rc), s	* 5.6	5.6	6.0	* 6	5.6	* 5.6	6.0	5.7				
Max Green Setting (Gmax), s	* 9.4	23.4	19.0	* 44	8.4	* 24	15.0	49.3				
Max Q Clear Time (g_c+I1), s	5.2	16.2	15.1	24.2	7.1	19.6	13.5	30.3				
Green Ext Time (p_c), s	0.0	0.8	0.1	3.3	0.0	1.0	0.1	3.0				

Intersection Summary

HCM 6th Ctrl Delay	59.0
HCM 6th LOS	E

Notes

User approved pedestrian interval to be less than phase max green.

* HCM 6th computational engine requires equal clearance times for the phases crossing the barrier.

Intersection												
Int Delay, s/veh	1.4											
Movement	EBL	EBT	EBR	WBL	WBT	WBR	NBL	NBT	NBR	SBL	SBT	SBR
Lane Configurations		↕	↗		↕	↗	↖	↕	↖	↖	↕	↗
Traffic Vol, veh/h	9	1	19	19	1	58	23	1015	26	27	774	40
Future Vol, veh/h	9	1	19	19	1	58	23	1015	26	27	774	40
Conflicting Peds, #/hr	0	0	0	0	0	0	0	0	0	0	0	0
Sign Control	Stop	Stop	Stop	Stop	Stop	Stop	Free	Free	Free	Free	Free	Free
RT Channelized	-	-	None	-	-	None	-	-	None	-	-	None
Storage Length	-	-	130	-	-	130	150	-	-	110	-	175
Veh in Median Storage, #	-	0	-	-	0	-	-	0	-	-	0	-
Grade, %	-	0	-	-	0	-	-	0	-	-	0	-
Peak Hour Factor	92	92	92	92	92	92	92	92	92	92	92	92
Heavy Vehicles, %	2	2	2	2	2	2	2	2	2	2	2	2
Mvmt Flow	10	1	21	21	1	63	25	1103	28	29	841	43

Major/Minor	Minor2		Minor1		Major1			Major2				
Conflicting Flow All	1501	2080	421	1632	2095	552	884	0	0	1131	0	0
Stage 1	899	899	-	1153	1153	-	-	-	-	-	-	-
Stage 2	602	1181	-	479	942	-	-	-	-	-	-	-
Critical Hdwy	7.54	6.54	6.94	7.54	6.54	6.94	4.14	-	-	4.14	-	-
Critical Hdwy Stg 1	6.54	5.54	-	6.54	5.54	-	-	-	-	-	-	-
Critical Hdwy Stg 2	6.54	5.54	-	6.54	5.54	-	-	-	-	-	-	-
Follow-up Hdwy	3.52	4.02	3.32	3.52	4.02	3.32	2.22	-	-	2.22	-	-
Pot Cap-1 Maneuver	173	65	*763	*126	63	477	*1141	-	-	613	-	-
Stage 1	704	620	-	*210	270	-	-	-	-	-	-	-
Stage 2	453	262	-	*719	584	-	-	-	-	-	-	-
Platoon blocked, %	1	1	1	1	1	1	1	-	-	-	-	-
Mov Cap-1 Maneuver	140	60	*763	*115	58	477	*1141	-	-	613	-	-
Mov Cap-2 Maneuver	140	60	-	*115	58	-	-	-	-	-	-	-
Stage 1	689	591	-	*205	264	-	-	-	-	-	-	-
Stage 2	383	256	-	*665	556	-	-	-	-	-	-	-

Approach	EB		WB		NB		SB	
HCM Control Delay, s	19.1		21.9		0.2		0.4	
HCM LOS	C		C					

Minor Lane/Major Mvmt	NBL	NBT	NBR	EBLn1	EBLn2	WBLn1	WBLn2	SBL	SBT	SBR
Capacity (veh/h)	* 1141	-	-	124	763	110	477	613	-	-
HCM Lane V/C Ratio	0.022	-	-	0.088	0.027	0.198	0.132	0.048	-	-
HCM Control Delay (s)	8.2	-	-	36.8	9.8	45.6	13.7	11.2	-	-
HCM Lane LOS	A	-	-	E	A	E	B	B	-	-
HCM 95th %tile Q(veh)	0.1	-	-	0.3	0.1	0.7	0.5	0.2	-	-

Notes
 ~: Volume exceeds capacity \$: Delay exceeds 300s +: Computation Not Defined *: All major volume in platoon



Appendix G – Trip Generation



Pass-By Calculations

Completed:

Checked:

After Pass-By

After Pass-By

Land Use	SF	BEFORE REDUCTION AM PEAK HR			PASS- BY	AM REDUCED			BEFORE REDUCTION PM PEAK HR			PASS- BY	PM REDUCED		
		ENTER	EXIT	TOTAL	Rate %	ENTER	EXIT	TOTAL	ENTER	EXIT	TOTAL	Rate %	ENTER	EXIT	TOTAL
Strip Retail Plaza (<40k)	25,250	-	-	-	-	-	-	-	83	83	166	34%	55	55	110
Quality Restaurant	35,120	-	-	-	-	-	-	-	184	90	274	44%	103	50	153
TOTAL		-	-	-		-	-	-	267	173	440		158	105	263

NCHRP 8-51 Internal Trip Capture Estimation Tool			
Project Name:	The Parque	Organization:	Lokahi
Project Location:	City of Scottsdale	Performed By:	TG
Scenario Description:		Date:	8/15/2022
Analysis Year:		Checked By:	GT
Analysis Period:	AM Street Peak Hour	Date:	8/16/2022

Table 1-A: Base Vehicle-Trip Generation Estimates (Single-Use Site Estimate)						
Land Use	Development Data (For Information Only)			Estimated Vehicle-Trips		
	ITE LUCs ¹	Quantity	Units	Total	Entering	Exiting
Office	710	150,000	1000 SF GLA	237	209	28
Retail	822	25,250	1000 SF GLA	60	36	24
Restaurant	932	35,120	1000 SF GLA	26	14	12
Cinema/Entertainment				0		
Residential	221	1,236	Units	532	122	410
Hotel	310	223	Keys	105	59	46
All Other Land Uses ²				0		
Total				960	440	520

Table 2-A: Mode Split and Vehicle Occupancy Estimates						
Land Use	Entering Trips			Exiting Trips		
	Veh. Occ.	% Transit	% Non-Motorized	Veh. Occ.	% Transit	% Non-Motorized
Office						
Retail						
Restaurant						
Cinema/Entertainment						
Residential						
Hotel						
All Other Land Uses ²						

Table 3-A: Average Land Use Interchange Distances (Feet Walking Distance)						
Origin (From)	Destination (To)					
	Office	Retail	Restaurant	Cinema/Entertainment	Residential	Hotel
Office						
Retail						
Restaurant						
Cinema/Entertainment						
Residential						
Hotel						

Table 4-A: Internal Person-Trip Origin-Destination Matrix*						
Origin (From)	Destination (To)					
	Office	Retail	Restaurant	Cinema/Entertainment	Residential	Hotel
Office		8	3	0	0	0
Retail	7		3	0	2	0
Restaurant	4	2		0	0	0
Cinema/Entertainment	0	0	0		0	0
Residential	6	4	3	0		0
Hotel	6	1	1	0	0	

Table 5-A: Computations Summary			
	Total	Entering	Exiting
All Person-Trips	960	440	520
Internal Capture Percentage	10%	11%	10%
External Vehicle-Trips ³	860	390	470
External Transit-Trips ⁴	0	0	0
External Non-Motorized Trips ⁴	0	0	0

Table 6-A: Internal Trip Capture Percentages by Land Use		
Land Use	Entering Trips	Exiting Trips
Office	11%	39%
Retail	42%	50%
Restaurant	71%	50%
Cinema/Entertainment	N/A	N/A
Residential	2%	3%
Hotel	0%	17%

¹Land Use Codes (LUCs) from *Trip Generation Informational Report*, published by the Institute of Transportation Engineers.

²Total estimate for all other land uses at mixed-use development site-not subject to internal trip capture computations in this estimator

³Vehicle-trips computed using the mode split and vehicle occupancy values provided in Table 2-A

⁴Person-Trips

*Indicates computation that has been rounded to the nearest whole number.

Estimation Tool Developed by the Texas Transportation Institute

Project Name:	The Parque
Analysis Period:	AM Street Peak Hour

Land Use	Table 7-A (D): Entering Trips			Table 7-A (O): Exiting Trips		
	Veh. Occ.	Vehicle-Trips	Person-Trips*	Veh. Occ.	Vehicle-Trips	Person-Trips*
Office	1.00	209	209	1.00	28	28
Retail	1.00	36	36	1.00	24	24
Restaurant	1.00	14	14	1.00	12	12
Cinema/Entertainment	1.00	0	0	1.00	0	0
Residential	1.00	122	122	1.00	410	410
Hotel	1.00	59	59	1.00	46	46

Origin (From)	Destination (To)					
	Office	Retail	Restaurant	Cinema/Entertainment	Residential	Hotel
Office		8	18	0	0	0
Retail	7		3	0	3	0
Restaurant	4	2		0	0	0
Cinema/Entertainment	0	0	0		0	0
Residential	8	4	82	0		0
Hotel	35	6	4	0	0	

Origin (From)	Destination (To)					
	Office	Retail	Restaurant	Cinema/Entertainment	Residential	Hotel
Office		12	3	0	0	0
Retail	8		7	0	2	0
Restaurant	29	3		0	6	2
Cinema/Entertainment	0	0	0		0	0
Residential	6	6	3	0		0
Hotel	6	1	1	0	0	

Destination Land Use	Person-Trip Estimates			External Trips by Mode*		
	Internal	External	Total	Vehicles ¹	Transit ²	Non-Motorized ²
Office	23	186	209	186	0	0
Retail	15	21	36	21	0	0
Restaurant	10	4	14	4	0	0
Cinema/Entertainment	0	0	0	0	0	0
Residential	2	120	122	120	0	0
Hotel	0	59	59	59	0	0
All Other Land Uses ³	0	0	0	0	0	0

Origin Land Use	Person-Trip Estimates			External Trips by Mode*		
	Internal	External	Total	Vehicles ¹	Transit ²	Non-Motorized ²
Office	11	17	28	17	0	0
Retail	12	12	24	12	0	0
Restaurant	6	6	12	6	0	0
Cinema/Entertainment	0	0	0	0	0	0
Residential	13	397	410	397	0	0
Hotel	8	38	46	38	0	0
All Other Land Uses ³	0	0	0	0	0	0

¹Vehicle-trips computed using the mode split and vehicle occupancy values provided in Table 2-A
²Person-Trips
³Total estimate for all other land uses at mixed-use development site-not subject to internal trip capture computations in this estimator
*Indicates computation that has been rounded to the nearest whole number.

NCHRP 8-51 Internal Trip Capture Estimation Tool					
Project Name:	The Parque			Organization:	Lokahi
Project Location:	City of Scottsdale			Performed By:	TG
Scenario Description:				Date:	8/15/2022
Analysis Year:				Checked By:	GT
Analysis Period:	PM Street Peak Hour			Date:	8/16/2022

Table 1-P: Base Vehicle-Trip Generation Estimates (Single-Use Site Estimate)						
Land Use	Development Data (For Information Only)			Estimated Vehicle-Trips		
	ITE LUCs ¹	Quantity	Units	Total	Entering	Exiting
Office	710	150,000		232	39	193
Retail	822	25,250	1000 SF GLA	110	55	55
Restaurant	931	35,120	1000 SF GLA	153	103	50
Cinema/Entertainment				0		
Residential	221	1,236	Units	482	294	188
Hotel	310	223	Keys	138	70	68
All Other Land Uses ²				0		
Total				1115	561	554

Table 2-P: Mode Split and Vehicle Occupancy Estimates						
Land Use	Entering Trips			Exiting Trips		
	Veh. Occ.	% Transit	% Non-Motorized	Veh. Occ.	% Transit	% Non-Motorized
Office						
Retail						
Restaurant						
Cinema/Entertainment						
Residential						
Hotel						
All Other Land Uses ²						

Table 3-P: Average Land Use Interchange Distances (Feet Walking Distance)						
Origin (From)	Destination (To)					
	Office	Retail	Restaurant	Cinema/Entertainment	Residential	Hotel
Office						
Retail						
Restaurant						
Cinema/Entertainment						
Residential						
Hotel						

Table 4-P: Internal Person-Trip Origin-Destination Matrix*						
Origin (From)	Destination (To)					
	Office	Retail	Restaurant	Cinema/Entertainment	Residential	Hotel
Office		4	2	0	4	0
Retail	1		16	0	14	3
Restaurant	2	21		0	9	4
Cinema/Entertainment	0	0	0		0	0
Residential	8	6	14	0		6
Hotel	0	1	5	0	0	

Table 5-P: Computations Summary			
	Total	Entering	Exiting
All Person-Trips	1,115	561	554
Internal Capture Percentage	22%	21%	22%
External Vehicle-Trips ³	875	441	434
External Transit-Trips ⁴	0	0	0
External Non-Motorized Trips ⁴	0	0	0

Table 6-P: Internal Trip Capture Percentages by Land Use		
Land Use	Entering Trips	Exiting Trips
Office	28%	5%
Retail	58%	62%
Restaurant	36%	72%
Cinema/Entertainment	N/A	N/A
Residential	9%	18%
Hotel	19%	9%

¹Land Use Codes (LUCs) from *Trip Generation Informational Report*, published by the Institute of Transportation Engineers.

²Total estimate for all other land uses at mixed-use development site-not subject to internal trip capture computations in this estimator

³Vehicle-trips computed using the mode split and vehicle occupancy values provided in Table 2-P

⁴Person-Trips

*Indicates computation that has been rounded to the nearest whole number.

Estimation Tool Developed by the Texas Transportation Institute

Project Name:	The Parque
Analysis Period:	PM Street Peak Hour

Table 7-P: Conversion of Vehicle-Trip Ends to Person-Trip Ends						
Land Use	Table 7-P (D): Entering Trips			Table 7-P (O): Exiting Trips		
	Veh. Occ.	Vehicle-Trips	Person-Trips*	Veh. Occ.	Vehicle-Trips	Person-Trips*
Office	1.00	39	39	1.00	193	193
Retail	1.00	55	55	1.00	55	55
Restaurant	1.00	103	103	1.00	50	50
Cinema/Entertainment	1.00	0	0	1.00	0	0
Residential	1.00	294	294	1.00	188	188
Hotel	1.00	70	70	1.00	68	68

Table 8-P (O): Internal Person-Trip Origin-Destination Matrix (Computed at Origin)						
Origin (From)	Destination (To)					
	Office	Retail	Restaurant	Cinema/Entertainment	Residential	Hotel
Office		39	8	0	4	0
Retail	1		16	2	14	3
Restaurant	2	21		4	9	4
Cinema/Entertainment	0	0	0		0	0
Residential	8	79	39	0		6
Hotel	0	11	46	0	1	

Table 8-P (D): Internal Person-Trip Origin-Destination Matrix (Computed at Destination)						
Origin (From)	Destination (To)					
	Office	Retail	Restaurant	Cinema/Entertainment	Residential	Hotel
Office		4	2	0	12	0
Retail	12		30	0	135	12
Restaurant	12	28		0	47	50
Cinema/Entertainment	2	2	3		12	1
Residential	22	6	14	0		8
Hotel	0	1	5	0	0	

Table 9-P (D): Internal and External Trips Summary (Entering Trips)						
Destination Land Use	Person-Trip Estimates			External Trips by Mode*		
	Internal	External	Total	Vehicles ¹	Transit ²	Non-Motorized ²
Office	11	28	39	28	0	0
Retail	32	23	55	23	0	0
Restaurant	37	66	103	66	0	0
Cinema/Entertainment	0	0	0	0	0	0
Residential	27	267	294	267	0	0
Hotel	13	57	70	57	0	0
All Other Land Uses ³	0	0	0	0	0	0

Table 9-P (O): Internal and External Trips Summary (Exiting Trips)						
Origin Land Use	Person-Trip Estimates			External Trips by Mode*		
	Internal	External	Total	Vehicles ¹	Transit ²	Non-Motorized ²
Office	10	183	193	183	0	0
Retail	34	21	55	21	0	0
Restaurant	36	14	50	14	0	0
Cinema/Entertainment	0	0	0	0	0	0
Residential	34	154	188	154	0	0
Hotel	6	62	68	62	0	0
All Other Land Uses ³	0	0	0	0	0	0

¹Vehicle-trips computed using the mode split and vehicle occupancy values provided in Table 2-P

²Person-Trips

³Total estimate for all other land uses at mixed-use development site-not subject to internal trip capture computations in this estimator

*Indicates computation that has been rounded to the nearest whole number.



**Appendix H – La Via Traffic Impact &
Mitigation Analysis, dated September
13, 2018**

La Via

THE VILLAGE FOR INNOVATION AND ART

TRAFFIC IMPACT & MITIGATION ANALYSIS



Prepared for:



JDM Partners LLC
2400 E. Arizona Biltmore Circle, Building 2, Suite 1270
Phoenix, AZ 85016

Prepared by:



J2 Engineering and Environmental Design
4649 E. Cotton Gin Loop, Suite B2
Phoenix, AZ 84040

Project Number: 17.1013
September 13, 2018



EXPIRES 6-30-19

01 Introduction and Summary

01.1. Purpose of Report and Study Objectives

J2 Engineering and Environmental Design was retained by JDM Partners LLC, to complete a Traffic Impact and Mitigation Analysis for the proposed La Via development located on the northeast corner of Scottsdale Road and Tierra Buena Lane, in Scottsdale, Arizona. The objective of this Traffic Impact and Mitigation Analysis is to analyze the traffic related impacts of the proposed development to the adjacent roadway network. See **Figure 1** for vicinity map.

The proposed mixed-use development will include office, retail, supermarket, multi-family residential, and hotel land uses. See **Figure 2** for the preliminary proposed land uses.

01.2. Executive Summary

This report presents the analyses and the results of a traffic study prepared for the proposed La Via Development, located on an approximately 28-acre parcel on the northeast corner of Scottsdale Road and Tierra Buena Lane. The proposed development is bound by Paradise Lane to the north, Dial Boulevard to the east, Tierra Buena Lane to the south and Scottsdale Road to the west.

The proposed development will be comprised of the following land uses:

- 604,050 square feet Office
- 86,560 square feet Retail
- 25,000 square feet Grocery
- 1,425 units Residential
- 300 rooms Hotel

This Traffic Impact and Mitigation Analysis includes:

- Level of service analysis of existing conditions for the weekday AM and PM peak hours
- Crash analysis for thirteen (13) intersections
- Trip generation for the proposed development
- Trip generation comparison to the existing development
- Trip generation comparison to the existing zoning
- Level of service analysis for the year 2022 weekday AM and PM peak hours
 - 2022 No Build
 - 2022 Build
- Level of service analysis for the year 2027 (build out) weekday AM and PM peak hours
 - 2027 No Build
 - 2027 Build

The following are the 20 intersections included in this study

- Scottsdale Road and Bell Road/Frank Lloyd Wright Boulevard (1)
- Scottsdale Road and Paradise Lane (2)
- Scottsdale Road and Tierra Buena Lane (3)
- Scottsdale Road and Kierland Boulevard/Greenway Hayden Loop (4)
- Scottsdale Road and Greenway Parkway/Butherus Drive (5)
- Dial Boulevard and Paradise Lane (6)
- Dial Boulevard and Monte Cristo Avenue/Driveway (7)
- Dial Boulevard and Tierra Buena Lane (8)
- Kierland Boulevard/Greenway Hayden Loop and Dial Boulevard (9)
- 76th Street and Frank Lloyd Wright Boulevard (10)
- 76th Street and Paradise Lane (11)
- Greenway Hayden Loop and Frank Lloyd Wright Boulevard (12)
- Greenway Hayden Loop and Paradise Lane (13)
- Tierra Buena Lane and Driveway A (14)
- Tierra Buena Lane and La Via Way (15)
- Dial Boulevard and Driveway C (16)
- Dial Boulevard and Driveway D (17)
- Paradise Lane and La Via Way/Promenade Driveway (18)
- Paradise Lane and Driveway F (19)
- Scottsdale Road and Driveway G (20)

Collision History

The most recent 3-year collision history (June 2014 – June 2017) was obtained from the City of Scottsdale for the thirteen (13) existing intersections and driveways.

- Scottsdale Road and Bell Road/Frank Lloyd Wright Boulevard (1)
- Scottsdale Road and Paradise Lane (2)
- Scottsdale Road and Tierra Buena Lane (3)
- Scottsdale Road and Kierland Boulevard/Greenway Hayden Loop (4)
- Scottsdale Road and Greenway Parkway/Butherus Drive (5)
- Dial Boulevard and Paradise Lane (6)
- Dial Boulevard and Monte Cristo Avenue (7)
- Dial Boulevard and Tierra Buena Lane (8)
- Kierland Boulevard/Greenway Hayden Loop and Dial Boulevard (9)
- 76th Street and Frank Lloyd Wright Boulevard (10)
- 76th Street and Paradise Lane (11)
- Greenway Hayden Loop and Frank Lloyd Wright Boulevard (12)
- Greenway Hayden Loop and Paradise Lane (13)

There were 266 collisions reported at the studied intersections listed above. 149 collisions were reported along Scottsdale Road, 89 collisions were reported along Greenway Hayden Loop, 2 collisions were reported along Dial Boulevard, and 26 collisions were reported along 76th Street. The intersection of Scottsdale Road and Bell Road/Frank Lloyd Wright Boulevard had the highest number of collisions 63.

The one fatal collision that occurred at the intersection of 76th Street and Frank Lloyd Wright Boulevard (10) on October 6th 2014, at 6:20 am and involved two (2) vehicles. A motorcycle traveling eastbound along Frank Lloyd Wright Boulevard was traveling at a speed too fast for conditions and struck a SUV making a westbound left off Frank Lloyd Wright Boulevard.

The one fatal collision that occurred at the intersection of Greenway Hayden Loop and Paradise Lane (13) on March 3, 2015, at 4:00 pm and involved three (3) vehicles. A motorcycle traveling eastbound along Paradise Lane failed to yield the right-of-way and was struck by a northbound vehicle traveling along Greenway Hayden Loop at a speed listed “too fast for conditions”.

The segment of Scottsdale Road from Paradise Lane to Frank Lloyd Wright Boulevard had a collision rate of 2.59, highest of all study roadway segments, which ranked 59th in the City. The intersection of Greenway Hayden Loop and Frank Lloyd Wright Boulevard had a 0.83 collision rate, highest of all study intersections, which ranked 53rd in the City.

No unusual collision patterns were identified among the reported collisions.

Existing Conditions

The AM and PM peak hour existing conditions capacity analysis were completed for the 18 existing intersections and driveways. Seven of the 17 intersections currently operate with AM and/or PM peak hour movements or overall intersection LOS E or F.

- Scottsdale Road and Bell Road/Frank Lloyd Wright Boulevard (1)
- Scottsdale Road and Paradise Lane (2)
- Scottsdale Road and Kierland Boulevard/Greenway Hayden Loop (4)
- Scottsdale Road and Greenway Parkway/Butherus Drive (5)
- 76th Street and Frank Lloyd Wright Boulevard (10)
- Greenway Hayden Loop and Frank Lloyd Wright Boulevard (12)
- Greenway Hayden Loop and Paradise Lane (13)

Trip Generation

The trip generations for the existing CrackerJax site, a potential C-4 zoning mix, as well as the proposed La Via development were calculated.

Trip Generation – Existing Development

Land Use	Weekday	AM Peak Hour			PM Peak Hour		
	Total	Total	In	Out	Total	In	Out
Existing CrackerJax Site	622	11	7	4	42	18	24

Trip Generation – Existing C-4 Zoning

Land Use	ITE Code	Qty	Unit	Weekday	AM Peak Hour			PM Peak Hour		
				Total	Total	In	Out	Total	In	Out
Automobile Sales (New)	840	27.70	1000 SF GFA	771	52	38	14	67	27	40
Automobile Care Center	942	44.72	1000 SF GFA	1,061	101	67	34	139	67	72
Furniture Store	890	130.37	1000 SF GFA	821	34	24	10	68	32	36
Free-Standing Super Store	813	208.77	1000 SF GFA	10,585	386	216	170	904	434	470
Free-Standing Super Store	813	151.91	1000 SF GFA	7,702	281	157	124	658	316	342
General Light Industrial	110	395.00	1000 SF GFA	1,959	277	244	33	249	32	217
Total				22,899	1,131	746	385	2,085	908	1,177

Trip Generation – Proposed La Via Development

Land Use	ITE Code	Qty	Unit	Weekday	AM Peak Hour			PM Peak Hour		
				Total	Total	In	Out	Total	In	Out
General Office Building	710	604.05	1000 SF GLA	6,073	594	511	83	629	101	528
Shopping Center	820	86.56	1000 SF GLA	5,450	195	121	74	488	234	254
Supermarket	850	25.00	1000 SF GLA	2,670	96	58	38	231	118	113
Multifamily Housing (Mid-Rise)	221	1,425	Dwelling Units	7,765	463	120	343	568	346	222
Hotel	310	300	Rooms	2,960	145	86	59	199	101	98
Total				24,918	1,493	896	597	2,115	900	1,215
Internal Capture and Pass-By Reductions				-3,381	-96	-62	-34	-528	-272	-256
New Trips Generated				21,537	1,397	834	563	1,587	628	959

Trip Generation – Comparison

A comparison between the trips generated by the existing CrackerJax site and the proposed La Via development as well as a comparison between the trips generated by the existing C-4 zoning and the proposed La Via development was calculated

Trip Generation Comparison (Existing Development vs. Proposed Development)

Land Use	Weekday	AM Peak Hour			PM Peak Hour		
	Total	Total	In	Out	Total	In	Out
Existing Development (CrackerJax)	622	11	7	4	42	18	24
Proposed Development (La Via)	21,537	1,397	834	563	1,587	628	959
Difference	20,915	1,386	827	559	1,545	610	935

Trip Generation Comparison (Existing Zoning vs. Proposed Development)

Land Use	Weekday	AM Peak Hour			PM Peak Hour		
	Total	Total	In	Out	Total	In	Out
Existing Zoning (C-4)	22,899	1,131	746	385	2,085	908	1,177
Proposed Development (La Via)	21,537	1,397	834	563	1,587	628	959
Difference	-1,362	266	88	178	-498	-280	-218

With the build out under the existing zoning, the proposed La Via development is anticipated to generate 1,362 (6%) fewer weekday trips, and 498 (24%) fewer PM peak hour trips.

Year 2022

The year 2022 analysis includes the build out of the following land uses:

- 221, 353 square feet Office
- 60,000 square feet Retail
- 25,000 square feet Supermarket
- 500 units Residential
- 300 units Hotel

A 1% annual growth rate was applied to the existing adjusted and balanced traffic volumes through year 2022 to account for background traffic volume growth. Additionally, the traffic volumes of known proposed surrounding developments were added and distributed throughout the studied roadway network. These developments include:

- District at the Quarter
- La Maison Hotel and Condo
- Optima Center Kierland
- Scottsdale Quarter Phase III

Year 2022 No Build

The AM and PM peak hour year 2022 no build conditions capacity analysis were completed for the 17 existing intersections and driveways. All movements operate at a LOS D or better, or are maintained at the existing level of service, with the exception of the following six out of 17 intersections:

- Scottsdale Road and Bell Road/Frank Lloyd Wright Boulevard (1)
- Scottsdale Road and Paradise Lane (2)
- Scottsdale Road and Tierra Buena Lane (3) – Signalized
- Scottsdale Road and Kierland Boulevard/Greenway Hayden Loop (4)
- Scottsdale Road and Greenway Parkway/Butherus Drive (5)
- Greenway Hayden Loop and Frank Lloyd Wright Boulevard (12)

Year 2022 No Build Improvements

The following are the recommended year 2022 no build improvements:

Scottsdale Road and Tierra Buena Lane (3)

In year 2022 without the build out of the proposed La Via development, the intersection of Scottsdale Road and Tierra Buena Lane (3) operates with an EB and WB LOS E and F, respectively, during the PM peak hour. Additionally, a traffic signal warrant study for the intersection resulted in satisfying Warrants 1, 2 and 3. Therefore, it is recommended for a traffic signal to be installed at this intersection.

Along with the installation of a traffic signal, pavement marking and signing modifications to the west leg are recommended to provide a dedicated left turn lane and a shared through-right turn lane. This improvement can be accommodated within the existing curb line.

Greenway Hayden Loop and Paradise Lane (13)

In year 2022 without the build out of the proposed La Via development, the intersection of Greenway Hayden Loop and Paradise Lane (13) continues to operate with an EB and WB LOS F during both the AM and PM peak hours as it does under the existing conditions. Additionally, a traffic signal warrant study for the intersection resulted in satisfying Warrants 1, 2, 3 and 7. Therefore, it is recommended for a traffic signal to be installed at this intersection. A roundabout could also be considered for installation at this intersection.

Along with the installation of a traffic signal, pavement marking and signing modifications to the west leg are recommended to provide an exclusive right turn lane. This improvement can be accommodated within the existing curb line.

For the installation of a roundabout, improvements includes a two-lane roundabout with a single lane approaches on the west and east legs, and two lane approaches on the north and south legs.

Based on the capacity analysis and traffic signal warrant analysis for the intersections of Scottsdale Road and Tierra Buena Lane (3), and Greenway Hayden Loop and Paradise Lane (13), the installation of a traffic signal at these two intersections significantly improves the traffic operation for the year 2022 no build condition, which does not include the build out of the Las Via development, but does include the four proposed surrounding developments. Therefore a traffic signal is assumed to be installed at these two intersections for the remainder of the analyses. A roundabout is also analyzed for the intersection of Greenway Hayden Loop and Paradise Lane (13).

Year 2022 Build

The AM and PM peak hour year 2022 build conditions capacity analysis were completed for the 19 existing and proposed intersections and driveways. All movements operate at a LOS D or better, or are maintained at the existing or year 2022 no build level of service, with the exception of the following five out of 18 intersections:

- Scottsdale Road and Bell Road/Frank Lloyd Wright Boulevard (1)
- Scottsdale Road and Tierra Buena Lane (3) - Signalized
- Scottsdale Road and Greenway Parkway/Butherus Drive (5)
- Greenway Hayden Loop and Frank Lloyd Wright Boulevard (12)

Year 2022 Build Improvements

The following are the recommended year 2022 improvements with the proposed 2022 build out of the La Via development:

Scottsdale Road and Paradise Lane (2)

During the PM peak hour there are 216 westbound left turning vehicles, and 307 westbound left turning vehicles. Due to these traffic volumes, adding a left turn lane and a right turn lane improves the overall operation of the westbound movement. The ultimate lane configuration includes dual left turn lanes, a through lane, and dual right turn lanes for the westbound movement and running a right turn overlap phase for the east and westbound right turn movements. The proposed lane configuration change can be accommodated within the existing curb line with pavement marking and signing modifications (including prohibiting southbound u-turns), traffic signal modifications, and potentially median modification on the east leg.

Dial Boulevard and Monte Cristo Avenue (7) improvements to include build out of the full access stop-controlled site driveway forming the west leg of the intersection with Monte Cristo Avenue. It is recommended for the driveway to provide an eastbound shared left-through-right turn lane. Although a left turn lane is not warranted for the northbound movement at this intersection, pavement marking modifications to the two-way left turn lane to provide a 100 foot exclusive left turn lane is recommended.

Tierra Buena Lane and Driveway A (14) improvements include build out of the stop-controlled Driveway A (north leg) providing a shared left-right turn lane. A left turn lane is warranted at this intersection for the eastbound movement. Therefore, pavement marking modifications to the two-way left turn lane to provide a 100 foot exclusive left turn lane is recommended.

Tierra Buena Lane and La Via Way (15) improvements include build out of the stop-controlled Driveway B/La Via Way (north leg) in place of the existing driveway providing a shared left-through-right turn lane. A left turn lane is warranted at this intersection for the eastbound movement. Therefore, pavement marking modifications to the two-way left turn lane to provide a 100 foot exclusive left turn lane is recommended. A right turn lane is warranted at this intersection for the westbound movement with a recommended storage length of 100 feet.

Paradise Lane and Driveway D (17) improvements to include build out of the stop-controlled Driveway D (west leg) providing full access to and from the site. It is recommended for the driveway to provide a shared left-right turn lane. A left turn lane is warranted at this intersection for the northbound movement. Therefore, pavement marking modifications to the two-way left turn lane to provide a 100 foot exclusive left turn lane is recommended. A right turn lane is warranted at this intersection for the southbound movement with a recommended storage length of 100 feet.

Paradise Lane and La Via Way (18) improvements to include build out of the stop-controlled Driveway E/La Via Way (south leg) providing a northbound shared left-through-right turn lane. A left turn lane is

warranted at this intersection for the westbound movement. Therefore, pavement marking modifications to the two-way left turn lane to provide a 100 foot exclusive left turn lane is recommended. A right turn lane is warranted at this intersection for the eastbound movement with a recommended storage length of 100 feet.

Paradise Lane and Driveway F (19) improvements to include build out of the stop-controlled Driveway F (south leg) providing a northbound shared left-right turn lane. A left turn lane is warranted at this intersection for the westbound movement. Therefore, pavement marking modifications to the two-way left turn lane to provide a 100 foot exclusive left turn lane is recommended. A right turn lane is warranted at this intersection for the eastbound movement with a recommended storage length of 100 feet.

Scottsdale Road and Driveway G (20) improvement to include the build out of the stop-controlled Driveway G (east leg) providing right-out access from the site. A northbound right turn lane is warranted at this intersection. The recommended storage length is 100 feet. Median modifications are necessary to provide an exclusive southbound left turn lane.

Year 2027 No Build

The AM and PM peak hour year 2022 no build conditions capacity analysis were completed for the 17 existing intersections and driveways. All movements operate at a LOS D or better, or are maintained at the existing or year 2022 no build level of service, with the exception of the following five out of 17 intersections:

- Scottsdale Road and Bell Road/Frank Lloyd Wright Boulevard (1)
- Scottsdale Road and Paradise Lane (2)
- Scottsdale Road and Tierra Buena Lane (3) - Signalized
- Scottsdale Road and Greenway Parkway/Butherus Drive (5)
- 76th Street and Frank Lloyd Wright Boulevard (10)

Year 2027 No Build Improvements

Year 2027 no build includes the year 2022 no build improvements. No additional improvements are recommended for the year 2027 no build.

Year 2027 Build

The AM and PM peak hour year 2022 build conditions capacity analysis were completed for the 20 existing and proposed intersections and driveways. All movements operate at a LOS D or better, or are maintained at the existing or year 2027 no build level of service, with the exception of the following eight out of 20 intersections:

- Scottsdale Road and Bell Road/Frank Lloyd Wright Boulevard (1)
- Scottsdale Road and Paradise Lane (2)
- Scottsdale Road and Greenway Parkway/Butherus Drive (5)
- 76th Street and Frank Lloyd Wright Boulevard (10)
- 76th Street and Paradise Lane (11)
- Greenway Hayden Loop and Frank Lloyd Wright Boulevard (12)
- Paradise Lane and La Via Way (18)
- Paradise Lane and Driveway F (19)

The northbound stop-controlled approaches at Paradise Lane and La Via Way (18), and Paradise Lane and Driveway F (19) operate at a LOS F during the PM peak hour. This is not uncommon in developed areas. Exiting drivers have an option to make a right turn and find alternative routes to their ultimate destinations rather than wait to make left turns. The other five intersections listed above are further away from the site or are not site related movements.

Year 2027 Build Improvements

The following are the recommended year 2027 improvements with the proposed 2027 build out of the La Via development:

Dial Boulevard and Driveway C (16) improvements to include build out of the stop-controlled Driveway C (west leg) providing full access to and from the site. It is recommended for the driveway to provide a shared left-right turn lane. A left turn lane is warranted at this intersection for the northbound movement. Therefore, pavement marking modifications to the two-way left turn lane to provide a 100 foot exclusive left turn lane is recommended. A right turn lane is warranted at this intersection for the southbound movement with a recommended storage length of 100 feet.

In general, the traffic operation at and surrounding the proposed La Via development will operate similar to existing conditions or future no build conditions. The proposed improvements at the intersections of Scottsdale Road and Paradise Lane (2), Scottsdale Road and Tierra Buena Lane (3), and Greenway Hayden Loop and Paradise Lane (13) are anticipated to improve overall traffic operations benefitting both the existing traffic and proposed surrounding developments, along with the proposed La Via development.



Appendix I – Year 2025 No Build Capacity Analysis

1: Scottsdale Road & Bell Road/Frank Lloyd Wright Boulevard

08/17/2022



Movement	EBL	EBT	EBR	WBL	WBT	WBR	NBL	NBT	NBR	SBL	SBT	SBR
Lane Configurations												
Traffic Volume (veh/h)	373	1076	292	161	429	197	120	607	102	353	1367	164
Future Volume (veh/h)	373	1076	292	161	429	197	120	607	102	353	1367	164
Initial Q (Qb), veh	0	0	0	0	0	0	0	0	0	0	0	0
Ped-Bike Adj(A_pbT)	1.00		1.00	1.00		1.00	1.00		1.00	1.00		1.00
Parking Bus, Adj	1.00	1.00	1.00	1.00	1.00	1.00	1.00	1.00	1.00	1.00	1.00	1.00
Work Zone On Approach		No			No			No			No	
Adj Sat Flow, veh/h/ln	1870	1870	1870	1870	1870	1870	1870	1870	1870	1870	1870	1870
Adj Flow Rate, veh/h	405	1170	317	175	466	214	130	660	111	384	1486	178
Peak Hour Factor	0.92	0.92	0.92	0.92	0.92	0.92	0.92	0.92	0.92	0.92	0.92	0.92
Percent Heavy Veh, %	2	2	2	2	2	2	2	2	2	2	2	2
Cap, veh/h	714	1309	406	228	600	697	187	803	249	1113	1957	234
Arrive On Green	0.21	0.26	0.26	0.13	0.23	0.23	0.02	0.05	0.05	0.32	0.42	0.42
Sat Flow, veh/h	3456	5106	1585	3456	5106	1585	3456	5106	1585	3456	4622	553
Grp Volume(v), veh/h	405	1170	317	175	466	214	130	660	111	384	1094	570
Grp Sat Flow(s),veh/h/ln	1728	1702	1585	1728	1702	1585	1728	1702	1585	1728	1702	1771
Q Serve(g_s), s	12.6	26.5	22.3	5.9	10.3	0.0	4.5	15.4	6.6	10.2	32.8	32.8
Cycle Q Clear(g_c), s	12.6	26.5	22.3	5.9	10.3	0.0	4.5	15.4	6.6	10.2	32.8	32.8
Prop In Lane	1.00		1.00	1.00		1.00	1.00		1.00	1.00		0.31
Lane Grp Cap(c), veh/h	714	1309	406	228	600	697	187	803	249	1113	1442	750
V/C Ratio(X)	0.57	0.89	0.78	0.77	0.78	0.31	0.70	0.82	0.45	0.35	0.76	0.76
Avail Cap(c_a), veh/h	714	1540	478	317	1030	830	346	1625	505	1113	1442	750
HCM Platoon Ratio	1.00	1.00	1.00	2.00	2.00	2.00	0.33	0.33	0.33	1.00	1.00	1.00
Upstream Filter(I)	1.00	1.00	1.00	0.99	0.99	0.99	0.83	0.83	0.83	1.00	1.00	1.00
Uniform Delay (d), s/veh	42.8	43.0	41.5	51.2	44.4	18.5	57.9	55.2	33.6	31.0	29.4	29.4
Incr Delay (d2), s/veh	0.7	5.8	5.6	4.3	0.8	0.1	1.5	7.9	4.7	0.1	3.8	7.1
Initial Q Delay(d3),s/veh	0.0	0.0	0.0	0.0	0.0	0.0	0.0	0.0	0.0	0.0	0.0	0.0
%ile BackOfQ(50%),veh/ln	5.3	11.4	9.0	2.5	3.8	3.2	2.0	7.6	3.6	4.1	13.4	14.6
Unsig. Movement Delay, s/veh												
LnGrp Delay(d),s/veh	43.4	48.8	47.1	55.5	45.3	18.6	59.4	63.1	38.3	31.1	33.2	36.5
LnGrp LOS	D	D	D	E	D	B	E	E	D	C	C	D
Approach Vol, veh/h		1892			855			901			2048	
Approach Delay, s/veh		47.4			40.7			59.5			33.7	
Approach LOS		D			D			E			C	
Timer - Assigned Phs	1	2	3	4	5	6	7	8				
Phs Duration (G+Y+Rc), s	12.5	56.8	30.8	19.9	44.6	24.7	13.9	36.8				
Change Period (Y+Rc), s	6.0	* 6	* 6	5.8	* 6	5.8	6.0	* 6				
Max Green Setting (Gmax), s	12.0	* 37	* 23	24.2	* 11	38.2	11.0	* 36				
Max Q Clear Time (g_c+I1), s	6.5	34.8	14.6	12.3	12.2	17.4	7.9	28.5				
Green Ext Time (p_c), s	0.1	1.2	0.5	1.8	0.0	1.5	0.1	2.2				

Intersection Summary

HCM 6th Ctrl Delay	43.4
HCM 6th LOS	D

Notes

User approved pedestrian interval to be less than phase max green.
 * HCM 6th computational engine requires equal clearance times for the phases crossing the barrier.

2: Scottsdale Road & Paradise Lane

08/17/2022

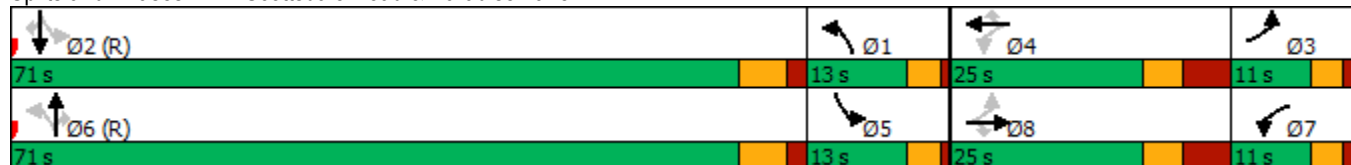


Lane Group	EBL	EBT	EBR	WBL	WBT	WBR	NBL	NBT	NBR	SBL	SBT	SBR
Lane Configurations	↘	↑	↗	↘	↑	↗	↘	↑↑↑	↗	↘	↑↑↑	↗
Traffic Volume (vph)	41	13	6	49	21	60	28	725	53	140	1390	48
Future Volume (vph)	41	13	6	49	21	60	28	725	53	140	1390	48
Turn Type	pm+pt	NA	Perm	pm+pt	NA	Perm	pm+pt	NA	Perm	pm+pt	NA	Perm
Protected Phases	3	8		7	4		1	6		5	2	
Permitted Phases	8		8	4		4	6		6	2		2
Detector Phase	3	8	8	7	4	4	1	6	6	5	2	2
Switch Phase												
Minimum Initial (s)	4.0	7.0	7.0	4.0	7.0	7.0	4.0	10.0	10.0	4.0	10.0	10.0
Minimum Split (s)	10.0	15.0	15.0	11.0	15.0	15.0	11.0	16.0	16.0	11.0	16.0	16.0
Total Split (s)	11.0	25.0	25.0	11.0	25.0	25.0	13.0	71.0	71.0	13.0	71.0	71.0
Total Split (%)	9.2%	20.8%	20.8%	9.2%	20.8%	20.8%	10.8%	59.2%	59.2%	10.8%	59.2%	59.2%
Yellow Time (s)	3.0	3.7	3.7	3.0	3.7	3.7	3.0	4.3	4.3	3.0	4.3	4.3
All-Red Time (s)	1.0	4.3	4.3	1.0	4.3	4.3	1.0	1.7	1.7	1.0	1.7	1.7
Lost Time Adjust (s)	0.0	0.0	0.0	0.0	0.0	0.0	0.0	0.0	0.0	0.0	0.0	0.0
Total Lost Time (s)	4.0	8.0	8.0	4.0	8.0	8.0	4.0	6.0	6.0	4.0	6.0	6.0
Lead/Lag	Lag	Lead	Lead	Lag	Lead	Lead	Lag	Lead	Lead	Lag	Lead	Lead
Lead-Lag Optimize?	Yes	Yes	Yes	Yes	Yes	Yes	Yes	Yes	Yes	Yes	Yes	Yes
Recall Mode	None	None	None	Min	None	None	Max	C-Min	C-Min	None	C-Min	C-Min
Act Effct Green (s)	9.9	7.0	7.0	17.6	7.2	7.2	71.7	33.2	33.2	93.0	50.5	50.5
Actuated g/C Ratio	0.08	0.06	0.06	0.15	0.06	0.06	0.60	0.28	0.28	0.78	0.42	0.42
v/c Ratio	0.30	0.13	0.04	0.22	0.21	0.34	0.05	0.56	0.11	0.16	0.71	0.07
Control Delay	51.9	56.5	0.3	45.3	58.1	8.5	6.7	36.7	9.6	16.7	18.7	1.0
Queue Delay	0.0	0.0	0.0	0.0	0.0	0.0	0.0	0.0	0.0	0.0	0.0	0.0
Total Delay	51.9	56.5	0.3	45.3	58.1	8.5	6.7	36.7	9.6	16.7	18.7	1.0
LOS	D	E	A	D	E	A	A	D	A	B	B	A
Approach Delay		47.4			30.4			33.8			18.0	
Approach LOS		D			C			C			B	

Intersection Summary

Cycle Length: 120
 Actuated Cycle Length: 120
 Offset: 20 (17%), Referenced to phase 2:SBTL and 6:NBTL, Start of 1st Green
 Natural Cycle: 60
 Control Type: Actuated-Coordinated
 Maximum v/c Ratio: 0.71
 Intersection Signal Delay: 24.3
 Intersection Capacity Utilization 54.6%
 Analysis Period (min) 15
 Intersection LOS: C
 ICU Level of Service A

Splits and Phases: 2: Scottsdale Road & Paradise Lane



2: Scottsdale Road & Paradise Lane

08/17/2022



Movement	EBL	EBT	EBR	WBL	WBT	WBR	NBL	NBT	NBR	SBL	SBT	SBR
Lane Configurations	↖	↑	↗	↖	↑	↗	↖	↑↑↑	↗	↖	↑↑↑	↗
Traffic Volume (veh/h)	41	13	6	49	21	60	28	725	53	140	1390	48
Future Volume (veh/h)	41	13	6	49	21	60	28	725	53	140	1390	48
Initial Q (Qb), veh	0	0	0	0	0	0	0	0	0	0	0	0
Ped-Bike Adj(A_pbT)	1.00		1.00	1.00		1.00	1.00		1.00	1.00		1.00
Parking Bus, Adj	1.00	1.00	1.00	1.00	1.00	1.00	1.00	1.00	1.00	1.00	1.00	1.00
Work Zone On Approach		No			No			No			No	
Adj Sat Flow, veh/h/ln	1870	1870	1870	1870	1870	1870	1870	1870	1870	1870	1870	1870
Adj Flow Rate, veh/h	45	14	7	53	23	65	30	788	58	152	1511	52
Peak Hour Factor	0.92	0.92	0.92	0.92	0.92	0.92	0.92	0.92	0.92	0.92	0.92	0.92
Percent Heavy Veh, %	2	2	2	2	2	2	2	2	2	2	2	2
Cap, veh/h	180	108	92	190	109	92	772	905	281	1041	1663	516
Arrive On Green	0.03	0.06	0.06	0.03	0.06	0.06	0.13	0.06	0.06	0.18	0.11	0.11
Sat Flow, veh/h	1781	1870	1585	1781	1870	1585	1781	5106	1585	1781	5106	1585
Grp Volume(v), veh/h	45	14	7	53	23	65	30	788	58	152	1511	52
Grp Sat Flow(s),veh/h/ln	1781	1870	1585	1781	1870	1585	1781	1702	1585	1781	1702	1585
Q Serve(g_s), s	0.0	0.9	0.5	0.0	1.4	4.8	0.0	18.4	4.2	4.1	35.1	3.6
Cycle Q Clear(g_c), s	0.0	0.9	0.5	0.0	1.4	4.8	0.0	18.4	4.2	4.1	35.1	3.6
Prop In Lane	1.00		1.00	1.00		1.00	1.00		1.00	1.00		1.00
Lane Grp Cap(c), veh/h	180	108	92	190	109	92	772	905	281	1041	1663	516
V/C Ratio(X)	0.25	0.13	0.08	0.28	0.21	0.71	0.04	0.87	0.21	0.15	0.91	0.10
Avail Cap(c_a), veh/h	224	265	225	235	265	225	772	2766	859	1041	2766	859
HCM Platoon Ratio	1.00	1.00	1.00	1.00	1.00	1.00	0.33	0.33	0.33	0.33	0.33	0.33
Upstream Filter(I)	1.00	1.00	1.00	1.00	1.00	1.00	1.00	1.00	1.00	0.50	0.50	0.50
Uniform Delay (d), s/veh	52.6	53.6	53.5	52.3	53.9	55.5	31.3	55.1	48.4	23.0	51.8	37.7
Incr Delay (d2), s/veh	0.3	0.2	0.1	0.3	0.4	3.7	0.1	11.2	1.7	0.0	4.8	0.2
Initial Q Delay(d3),s/veh	0.0	0.0	0.0	0.0	0.0	0.0	0.0	0.0	0.0	0.0	0.0	0.0
%ile BackOfQ(50%),veh/ln	1.3	0.4	0.2	1.5	0.7	2.0	0.7	9.3	1.8	3.4	16.7	1.5
Unsig. Movement Delay, s/veh												
LnGrp Delay(d),s/veh	52.9	53.8	53.6	52.6	54.3	59.2	31.4	66.3	50.1	23.0	56.6	37.9
LnGrp LOS	D	D	D	D	D	E	C	E	D	C	E	D
Approach Vol, veh/h		66			141			876			1715	
Approach Delay, s/veh		53.2			55.9			64.1			53.0	
Approach LOS		D			E			E			D	
Timer - Assigned Phs	1	2	3	4	5	6	7	8				
Phs Duration (G+Y+Rc), s	51.9	45.1	8.0	15.0	69.8	27.3	8.0	15.0				
Change Period (Y+Rc), s	* 4	6.0	* 4	8.0	* 4	6.0	* 4	8.0				
Max Green Setting (Gmax), s	* 9	65.0	* 7	17.0	* 9	65.0	* 7	17.0				
Max Q Clear Time (g_c+I1), s	2.0	37.1	2.0	6.8	6.1	20.4	2.0	2.9				
Green Ext Time (p_c), s	0.0	2.0	0.0	0.1	0.0	0.9	0.0	0.0				

Intersection Summary

HCM 6th Ctrl Delay	56.6
HCM 6th LOS	E

Notes

- User approved pedestrian interval to be less than phase max green.
- * HCM 6th computational engine requires equal clearance times for the phases crossing the barrier.

Intersection						
Int Delay, s/veh	0					
Movement	EBL	EBR	NBL	NBT	SBT	SBR
Lane Configurations		↗	↘	↑↑↑	↑↑↑	↗
Traffic Vol, veh/h	0	2	6	805	1446	3
Future Vol, veh/h	0	2	6	805	1446	3
Conflicting Peds, #/hr	0	0	0	0	0	0
Sign Control	Stop	Stop	Free	Free	Free	Free
RT Channelized	-	None	-	None	-	None
Storage Length	-	0	110	-	-	110
Veh in Median Storage, #	0	-	-	0	0	-
Grade, %	0	-	-	0	0	-
Peak Hour Factor	92	92	92	92	92	92
Heavy Vehicles, %	2	2	2	2	2	2
Mvmt Flow	0	2	7	875	1572	3

Major/Minor	Minor2	Major1	Major2		
Conflicting Flow All	-	786	1575	0	-
Stage 1	-	-	-	-	-
Stage 2	-	-	-	-	-
Critical Hdwy	-	7.14	5.34	-	-
Critical Hdwy Stg 1	-	-	-	-	-
Critical Hdwy Stg 2	-	-	-	-	-
Follow-up Hdwy	-	3.92	3.12	-	-
Pot Cap-1 Maneuver	0	*588	*740	-	-
Stage 1	0	-	-	-	-
Stage 2	0	-	-	-	-
Platoon blocked, %		1	1	-	-
Mov Cap-1 Maneuver	-	*588	*740	-	-
Mov Cap-2 Maneuver	-	-	-	-	-
Stage 1	-	-	-	-	-
Stage 2	-	-	-	-	-

Approach	EB	NB	SB
HCM Control Delay, s	11.1	0.1	0
HCM LOS	B		

Minor Lane/Major Mvmt	NBL	NBT	EBLn1	SBT	SBR
Capacity (veh/h)	* 740	-	588	-	-
HCM Lane V/C Ratio	0.009	-	0.004	-	-
HCM Control Delay (s)	9.9	-	11.1	-	-
HCM Lane LOS	A	-	B	-	-
HCM 95th %tile Q(veh)	0	-	0	-	-

Notes
 ~: Volume exceeds capacity \$: Delay exceeds 300s +: Computation Not Defined *: All major volume in platoon

Intersection												
Int Delay, s/veh	1.2											
Movement	EBL	EBT	EBR	WBL	WBT	WBR	NBL	NBT	NBR	SBL	SBT	SBR
Lane Configurations	↖	↗		↖	↗	↖	↖	↖↖↖	↖	↖	↖↖↖	↖
Traffic Vol, veh/h	11	3	15	13	1	71	13	734	42	76	1349	17
Future Vol, veh/h	11	3	15	13	1	71	13	734	42	76	1349	17
Conflicting Peds, #/hr	0	0	0	0	0	0	0	0	0	0	0	0
Sign Control	Stop	Stop	Stop	Stop	Stop	Stop	Free	Free	Free	Free	Free	Free
RT Channelized	-	-	None	-	-	None	-	-	None	-	-	None
Storage Length	100	-	-	80	-	115	200	-	205	195	-	100
Veh in Median Storage, #	-	0	-	-	0	-	-	0	-	-	0	-
Grade, %	-	0	-	-	0	-	-	0	-	-	0	-
Peak Hour Factor	92	92	92	92	92	92	92	92	92	92	92	92
Heavy Vehicles, %	2	2	2	2	2	2	2	2	2	2	2	2
Mvmt Flow	12	3	16	14	1	77	14	798	46	83	1466	18

Major/Minor	Minor2		Minor1		Major1			Major2				
Conflicting Flow All	1980	2504	733	1580	2476	399	1484	0	0	844	0	0
Stage 1	1632	1632	-	826	826	-	-	-	-	-	-	-
Stage 2	348	872	-	754	1650	-	-	-	-	-	-	-
Critical Hdwy	6.44	6.54	7.14	6.44	6.54	7.14	5.34	-	-	5.34	-	-
Critical Hdwy Stg 1	7.34	5.54	-	7.34	5.54	-	-	-	-	-	-	-
Critical Hdwy Stg 2	6.74	5.54	-	6.74	5.54	-	-	-	-	-	-	-
Follow-up Hdwy	3.82	4.02	3.92	3.82	4.02	3.92	3.12	-	-	3.12	-	-
Pot Cap-1 Maneuver	*162	57	*610	*331	60	*761	*767	-	-	865	-	-
Stage 1	*470	494	-	*698	690	-	-	-	-	-	-	-
Stage 2	*781	653	-	*626	481	-	-	-	-	-	-	-
Platoon blocked, %	1	1	1	1	1	1	1	-	-	1	-	-
Mov Cap-1 Maneuver	*131	50	*610	*280	53	*761	*767	-	-	865	-	-
Mov Cap-2 Maneuver	*131	50	-	*280	53	-	-	-	-	-	-	-
Stage 1	*462	446	-	*686	678	-	-	-	-	-	-	-
Stage 2	*688	642	-	*547	435	-	-	-	-	-	-	-

Approach	EB		WB		NB		SB	
HCM Control Delay, s	28		12.3		0.2		0.5	
HCM LOS	D		B					

Minor Lane/Major Mvmt	NBL	NBT	NBR	EBLn1	EBLn2	WBLn1	WBLn2	WBLn3	SBL	SBT	SBR
Capacity (veh/h)	*767	-	-	131	213	280	53	761	865	-	-
HCM Lane V/C Ratio	0.018	-	-	0.091	0.092	0.05	0.021	0.101	0.096	-	-
HCM Control Delay (s)	9.8	-	-	35.2	23.6	18.5	74.3	10.3	9.6	-	-
HCM Lane LOS	A	-	-	E	C	C	F	B	A	-	-
HCM 95th %tile Q(veh)	0.1	-	-	0.3	0.3	0.2	0.1	0.3	0.3	-	-

Notes
 ~: Volume exceeds capacity \$: Delay exceeds 300s +: Computation Not Defined *: All major volume in platoon

5: Scottsdale Road & Kierland Boulevard/Greenway Hayden Loop

08/17/2022



Movement	EBL	EBT	EBR	WBL	WBT	WBR	NBL	NBT	NBR	SBL	SBT	SBR
Lane Configurations	↔↔	↑↑	↔	↔↔	↑↑↔		↔↔	↑↑↑	↔	↔↔	↑↑↑	↔
Traffic Volume (veh/h)	44	129	39	237	170	45	39	717	374	141	1068	144
Future Volume (veh/h)	44	129	39	237	170	45	39	717	374	141	1068	144
Initial Q (Qb), veh	0	0	0	0	0	0	0	0	0	0	0	0
Ped-Bike Adj(A_pbT)	1.00		1.00	1.00		1.00	1.00		1.00	1.00		1.00
Parking Bus, Adj	1.00	1.00	1.00	1.00	1.00	1.00	1.00	1.00	1.00	1.00	1.00	1.00
Work Zone On Approach		No			No			No			No	
Adj Sat Flow, veh/h/ln	1870	1870	1870	1870	1870	1870	1870	1870	1870	1870	1870	1870
Adj Flow Rate, veh/h	48	140	42	258	185	49	42	779	407	153	1161	157
Peak Hour Factor	0.92	0.92	0.92	0.92	0.92	0.92	0.92	0.92	0.92	0.92	0.92	0.92
Percent Heavy Veh, %	2	2	2	2	2	2	2	2	2	2	2	2
Cap, veh/h	273	213	95	315	291	73	1370	1102	342	1528	1336	415
Arrive On Green	0.08	0.06	0.06	0.03	0.02	0.02	0.79	0.43	0.43	0.88	0.52	0.52
Sat Flow, veh/h	3456	3554	1585	3456	4074	1017	3456	5106	1585	3456	5106	1585
Grp Volume(v), veh/h	48	140	42	258	153	81	42	779	407	153	1161	157
Grp Sat Flow(s),veh/h/ln	1728	1777	1585	1728	1702	1687	1728	1702	1585	1728	1702	1585
Q Serve(g_s), s	1.6	4.6	1.5	8.9	5.3	5.7	0.3	15.0	19.8	0.7	23.9	7.1
Cycle Q Clear(g_c), s	1.6	4.6	1.5	8.9	5.3	5.7	0.3	15.0	19.8	0.7	23.9	7.1
Prop In Lane	1.00		1.00	1.00		0.60	1.00		1.00	1.00		1.00
Lane Grp Cap(c), veh/h	273	213	95	315	243	121	1370	1102	342	1528	1336	415
V/C Ratio(X)	0.18	0.66	0.44	0.82	0.63	0.67	0.03	0.71	1.19	0.10	0.87	0.38
Avail Cap(c_a), veh/h	308	930	415	328	916	454	1370	2055	638	1528	2055	638
HCM Platoon Ratio	1.00	1.00	1.00	0.33	0.33	0.33	2.00	2.00	2.00	2.00	2.00	2.00
Upstream Filter(I)	1.00	1.00	1.00	0.88	0.88	0.88	0.93	0.93	0.93	1.00	1.00	1.00
Uniform Delay (d), s/veh	51.6	55.2	12.3	57.2	57.0	57.2	7.5	31.0	19.9	3.9	26.8	22.8
Incr Delay (d2), s/veh	0.1	1.3	1.2	12.0	0.9	2.2	0.0	3.6	109.4	0.0	7.9	2.6
Initial Q Delay(d3),s/veh	0.0	0.0	0.0	0.0	0.0	0.0	0.0	0.0	0.0	0.0	0.0	0.0
%ile BackOfQ(50%),veh/ln	0.7	2.1	1.2	4.6	2.4	2.6	0.1	5.1	15.3	0.2	7.2	2.6
Unsig. Movement Delay, s/veh												
LnGrp Delay(d),s/veh	51.7	56.5	13.5	69.3	57.9	59.4	7.5	34.6	129.3	3.9	34.7	25.4
LnGrp LOS	D	E	B	E	E	E	A	C	F	A	C	C
Approach Vol, veh/h		230			492			1228			1471	
Approach Delay, s/veh		47.6			64.1			65.0			30.5	
Approach LOS		D			E			E			C	
Timer - Assigned Phs	1	2	3	4	5	6	7	8				
Phs Duration (G+Y+Rc), s	53.6	37.1	15.1	14.3	59.1	31.6	16.5	12.8				
Change Period (Y+Rc), s	6.0	5.7	* 5.6	* 5.7	6.0	5.7	5.6	* 5.6				
Max Green Setting (Gmax), s	6.0	48.3	* 11	* 32	6.0	48.3	11.4	* 31				
Max Q Clear Time (g_c+I1), s	2.3	25.9	3.6	7.7	2.7	21.8	10.9	6.6				
Green Ext Time (p_c), s	0.0	5.5	0.0	0.8	0.1	4.1	0.0	0.6				

Intersection Summary

HCM 6th Ctrl Delay	48.9
HCM 6th LOS	D

Notes

User approved pedestrian interval to be less than phase max green.
 * HCM 6th computational engine requires equal clearance times for the phases crossing the barrier.

6: Scottsdale Road & Greenway Parkway/Butherus Drive

08/17/2022

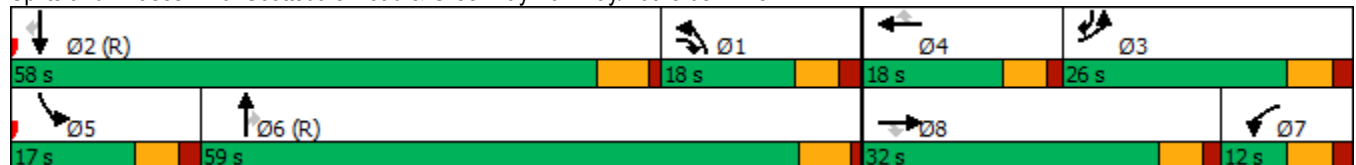


Lane Group	EBL	EBT	EBR	WBL	WBT	WBR	NBL	NBT	NBR	SBL	SBT	SBR
Lane Configurations	↖↗	↕	↗	↖↗	↕	↗	↖↗	↕↕↕	↗	↖↗	↕↕↕	↗
Traffic Volume (vph)	265	376	323	86	63	32	166	851	267	132	1099	94
Future Volume (vph)	265	376	323	86	63	32	166	851	267	132	1099	94
Turn Type	Prot	NA	pm+ov	Prot	NA	Perm	Prot	NA	Perm	Prot	NA	pm+ov
Protected Phases	3	8	1	7	4		1	6		5	2	3
Permitted Phases			8			4			6			2
Detector Phase	3	8	1	7	4	4	1	6	6	5	2	3
Switch Phase												
Minimum Initial (s)	5.0	7.0	5.0	5.0	7.0	7.0	5.0	10.0	10.0	5.0	10.0	5.0
Minimum Split (s)	11.0	13.2	11.0	11.0	13.2	13.2	11.0	16.0	16.0	11.0	16.0	11.0
Total Split (s)	26.0	32.0	18.0	12.0	18.0	18.0	18.0	59.0	59.0	17.0	58.0	26.0
Total Split (%)	21.7%	26.7%	15.0%	10.0%	15.0%	15.0%	15.0%	49.2%	49.2%	14.2%	48.3%	21.7%
Yellow Time (s)	4.0	4.0	4.0	4.0	4.0	4.0	4.0	4.7	4.7	4.0	4.7	4.0
All-Red Time (s)	2.0	1.5	2.0	2.0	1.5	1.5	2.0	1.0	1.0	2.0	1.0	2.0
Lost Time Adjust (s)	0.0	0.0	0.0	0.0	0.0	0.0	0.0	0.0	0.0	0.0	0.0	0.0
Total Lost Time (s)	6.0	5.5	6.0	6.0	5.5	5.5	6.0	5.7	5.7	6.0	5.7	6.0
Lead/Lag	Lag	Lead	Lag	Lag	Lead	Lead	Lag	Lag	Lag	Lead	Lead	Lag
Lead-Lag Optimize?	Yes	Yes	Yes	Yes	Yes	Yes	Yes	Yes	Yes	Yes	Yes	Yes
Recall Mode	None	None	None	None	None	None	None	C-Min	C-Min	None	C-Min	None
Act Effct Green (s)	25.4	22.7	40.2	7.6	7.4	7.4	12.0	57.3	57.3	9.1	54.5	85.6
Actuated g/C Ratio	0.21	0.19	0.34	0.06	0.06	0.06	0.10	0.48	0.48	0.08	0.45	0.71
v/c Ratio	0.40	0.82	0.41	0.43	0.31	0.11	0.53	0.38	0.33	0.55	0.52	0.09
Control Delay	42.3	55.2	13.3	59.6	57.5	0.7	56.1	21.7	7.6	48.8	28.4	1.6
Queue Delay	0.0	0.0	0.0	0.0	0.0	0.0	0.0	0.0	0.0	0.0	0.0	0.0
Total Delay	42.3	55.2	13.3	59.6	57.5	0.7	56.1	21.7	7.6	48.8	28.4	1.6
LOS	D	E	B	E	E	A	E	C	A	D	C	A
Approach Delay		42.4			48.4			23.2			28.5	
Approach LOS		D			D			C			C	

Intersection Summary

Cycle Length: 120
 Actuated Cycle Length: 120
 Offset: 53 (44%), Referenced to phase 2:SBT and 6:NBT, Start of 1st Green
 Natural Cycle: 60
 Control Type: Actuated-Coordinated
 Maximum v/c Ratio: 0.82
 Intersection Signal Delay: 31.2
 Intersection Capacity Utilization 63.3%
 Analysis Period (min) 15
 Intersection LOS: C
 ICU Level of Service B

Splits and Phases: 6: Scottsdale Road & Greenway Parkway/Butherus Drive



6: Scottsdale Road & Greenway Parkway/Butherus Drive

08/17/2022



Movement	EBL	EBT	EBR	WBL	WBT	WBR	NBL	NBT	NBR	SBL	SBT	SBR
Lane Configurations	↔↔	↕↔	↔	↔↔	↕↕	↔	↔↔	↕↕↕	↔	↔↔	↕↕↕	↔
Traffic Volume (veh/h)	265	376	323	86	63	32	166	851	267	132	1099	94
Future Volume (veh/h)	265	376	323	86	63	32	166	851	267	132	1099	94
Initial Q (Qb), veh	0	0	0	0	0	0	0	0	0	0	0	0
Ped-Bike Adj(A_pbT)	1.00		1.00	1.00		1.00	1.00		1.00	1.00		1.00
Parking Bus, Adj	1.00	1.00	1.00	1.00	1.00	1.00	1.00	1.00	1.00	1.00	1.00	1.00
Work Zone On Approach		No			No			No			No	
Adj Sat Flow, veh/h/ln	1870	1870	1870	1870	1870	1870	1870	1870	1870	1870	1870	1870
Adj Flow Rate, veh/h	288	556	253	93	68	35	180	925	0	143	1195	102
Peak Hour Factor	0.92	0.92	0.92	0.92	0.92	0.92	0.92	0.92	0.92	0.92	0.92	0.92
Percent Heavy Veh, %	2	2	2	2	2	2	2	2	2	2	2	2
Cap, veh/h	563	655	787	143	207	92	1112	2712		196	1372	676
Arrive On Green	0.16	0.17	0.17	0.04	0.06	0.06	0.32	0.53	0.00	0.11	0.54	0.54
Sat Flow, veh/h	3563	3741	1585	3456	3554	1585	3456	5106	1585	3456	5106	1585
Grp Volume(v), veh/h	288	556	253	93	68	35	180	925	0	143	1195	102
Grp Sat Flow(s),veh/h/ln	1781	1870	1585	1728	1777	1585	1728	1702	1585	1728	1702	1585
Q Serve(g_s), s	8.9	17.3	0.0	3.2	2.2	2.1	4.5	12.4	0.0	4.8	24.4	0.0
Cycle Q Clear(g_c), s	8.9	17.3	0.0	3.2	2.2	2.1	4.5	12.4	0.0	4.8	24.4	0.0
Prop In Lane	1.00		1.00	1.00		1.00	1.00		1.00	1.00		1.00
Lane Grp Cap(c), veh/h	563	655	787	143	207	92	1112	2712		196	1372	676
V/C Ratio(X)	0.51	0.85	0.32	0.65	0.33	0.38	0.16	0.34		0.73	0.87	0.15
Avail Cap(c_a), veh/h	594	826	860	173	370	165	1112	2712		317	2225	941
HCM Platoon Ratio	1.00	1.00	1.00	1.00	1.00	1.00	1.00	1.00	1.00	2.00	2.00	2.00
Upstream Filter(I)	1.00	1.00	1.00	1.00	1.00	1.00	1.00	1.00	0.00	0.90	0.90	0.90
Uniform Delay (d), s/veh	46.3	48.0	18.1	56.7	54.2	38.2	29.1	16.1	0.0	52.3	26.0	13.0
Incr Delay (d2), s/veh	0.3	5.7	0.1	3.5	0.3	0.9	0.0	0.3	0.0	1.7	7.1	0.4
Initial Q Delay(d3),s/veh	0.0	0.0	0.0	0.0	0.0	0.0	0.0	0.0	0.0	0.0	0.0	0.0
%ile BackOfQ(50%),veh/ln	3.9	8.3	4.0	1.4	1.0	1.0	1.8	4.6	0.0	2.0	7.1	1.1
Unsig. Movement Delay, s/veh												
LnGrp Delay(d),s/veh	46.6	53.7	18.2	60.1	54.6	39.1	29.1	16.5	0.0	54.0	33.1	13.4
LnGrp LOS	D	D	B	E	D	D	C	B		D	C	B
Approach Vol, veh/h		1097			196			1105			1440	
Approach Delay, s/veh		43.6			54.5			18.5			33.8	
Approach LOS		D			D			B			C	
Timer - Assigned Phs	1	2	3	4	5	6	7	8				
Phs Duration (G+Y+Rc), s	44.6	37.9	25.0	12.5	12.8	69.7	11.0	26.5				
Change Period (Y+Rc), s	6.0	5.7	6.0	5.5	6.0	* 6	6.0	5.5				
Max Green Setting (Gmax), s	12.0	52.3	20.0	12.5	11.0	* 53	6.0	26.5				
Max Q Clear Time (g_c+I1), s	6.5	26.4	10.9	4.2	6.8	14.4	5.2	19.3				
Green Ext Time (p_c), s	0.1	5.8	0.4	0.1	0.1	4.3	0.0	1.7				

Intersection Summary

HCM 6th Ctrl Delay	33.2
HCM 6th LOS	C

Notes

- User approved pedestrian interval to be less than phase max green.
- User approved volume balancing among the lanes for turning movement.
- * HCM 6th computational engine requires equal clearance times for the phases crossing the barrier.

Intersection						
Int Delay, s/veh	1.7					
Movement	EBL	EBT	WBT	WBR	SBL	SBR
Lane Configurations						
Traffic Vol, veh/h	28	183	100	16	14	30
Future Vol, veh/h	28	183	100	16	14	30
Conflicting Peds, #/hr	0	0	0	0	0	0
Sign Control	Free	Free	Free	Free	Stop	Stop
RT Channelized	-	None	-	None	-	None
Storage Length	100	-	-	-	0	-
Veh in Median Storage, #	-	0	0	-	0	-
Grade, %	-	0	0	-	0	-
Peak Hour Factor	92	92	92	92	92	92
Heavy Vehicles, %	2	2	2	2	2	2
Mvmt Flow	30	199	109	17	15	33
Major/Minor	Major1	Major2	Minor2			
Conflicting Flow All	126	0	-	0	377	118
Stage 1	-	-	-	-	118	-
Stage 2	-	-	-	-	259	-
Critical Hdwy	4.12	-	-	-	6.42	6.22
Critical Hdwy Stg 1	-	-	-	-	5.42	-
Critical Hdwy Stg 2	-	-	-	-	5.42	-
Follow-up Hdwy	2.218	-	-	-	3.518	3.318
Pot Cap-1 Maneuver	1460	-	-	-	675	934
Stage 1	-	-	-	-	907	-
Stage 2	-	-	-	-	823	-
Platoon blocked, %		-	-	-	1	
Mov Cap-1 Maneuver	1460	-	-	-	661	934
Mov Cap-2 Maneuver	-	-	-	-	690	-
Stage 1	-	-	-	-	888	-
Stage 2	-	-	-	-	823	-
Approach	EB	WB	SB			
HCM Control Delay, s	1	0	9.5			
HCM LOS			A			
Minor Lane/Major Mvmt	EBL	EBT	WBT	WBR	SBLn1	
Capacity (veh/h)	1460	-	-	-	840	
HCM Lane V/C Ratio	0.021	-	-	-	0.057	
HCM Control Delay (s)	7.5	-	-	-	9.5	
HCM Lane LOS	A	-	-	-	A	
HCM 95th %tile Q(veh)	0.1	-	-	-	0.2	

Intersection						
Int Delay, s/veh	2.1					
Movement	EBT	EBR	WBL	WBT	NBL	NBR
Lane Configurations						
Traffic Vol, veh/h	147	49	15	84	37	32
Future Vol, veh/h	147	49	15	84	37	32
Conflicting Peds, #/hr	0	0	0	0	0	0
Sign Control	Free	Free	Free	Free	Stop	Stop
RT Channelized	-	None	-	None	-	None
Storage Length	-	-	100	-	80	0
Veh in Median Storage, #	0	-	-	0	0	-
Grade, %	0	-	-	0	0	-
Peak Hour Factor	92	92	92	92	92	92
Heavy Vehicles, %	2	2	2	2	2	2
Mvmt Flow	160	53	16	91	40	35

Major/Minor	Major1	Major2	Minor1	Minor2	Minor3
Conflicting Flow All	0	0	213	0	310
Stage 1	-	-	-	-	187
Stage 2	-	-	-	-	123
Critical Hdwy	-	-	4.12	-	6.42
Critical Hdwy Stg 1	-	-	-	-	5.42
Critical Hdwy Stg 2	-	-	-	-	5.42
Follow-up Hdwy	-	-	2.218	-	3.518
Pot Cap-1 Maneuver	-	-	1378	-	731
Stage 1	-	-	-	-	883
Stage 2	-	-	-	-	902
Platoon blocked, %	-	-	1	-	1
Mov Cap-1 Maneuver	-	-	1378	-	722
Mov Cap-2 Maneuver	-	-	-	-	734
Stage 1	-	-	-	-	883
Stage 2	-	-	-	-	891

Approach	EB	WB	NB
HCM Control Delay, s	0	1.2	9.6
HCM LOS			A

Minor Lane/Major Mvmt	NBLn1	NBLn2	EBT	EBR	WBL	WBT
Capacity (veh/h)	734	927	-	-	1378	-
HCM Lane V/C Ratio	0.055	0.038	-	-	0.012	-
HCM Control Delay (s)	10.2	9	-	-	7.6	-
HCM Lane LOS	B	A	-	-	A	-
HCM 95th %tile Q(veh)	0.2	0.1	-	-	0	-

Intersection						
Int Delay, s/veh	1.9					
Movement	WBL	WBR	NBT	NBR	SBL	SBT
Lane Configurations	↙	↗	↖		↙	↗
Traffic Vol, veh/h	6	9	56	29	24	42
Future Vol, veh/h	6	9	56	29	24	42
Conflicting Peds, #/hr	0	0	0	0	0	0
Sign Control	Stop	Stop	Free	Free	Free	Free
RT Channelized	-	None	-	None	-	None
Storage Length	75	0	-	-	100	-
Veh in Median Storage, #	0	-	0	-	-	0
Grade, %	0	-	0	-	-	0
Peak Hour Factor	92	92	92	92	92	92
Heavy Vehicles, %	2	2	2	2	2	2
Mvmt Flow	7	10	61	32	26	46

Major/Minor	Minor1	Major1	Major2			
Conflicting Flow All	175	77	0	0	93	0
Stage 1	77	-	-	-	-	-
Stage 2	98	-	-	-	-	-
Critical Hdwy	6.42	6.22	-	-	4.12	-
Critical Hdwy Stg 1	5.42	-	-	-	-	-
Critical Hdwy Stg 2	5.42	-	-	-	-	-
Follow-up Hdwy	3.518	3.318	-	-	2.218	-
Pot Cap-1 Maneuver	815	984	-	-	1501	-
Stage 1	946	-	-	-	-	-
Stage 2	926	-	-	-	-	-
Platoon blocked, %			-	-	-	-
Mov Cap-1 Maneuver	801	984	-	-	1501	-
Mov Cap-2 Maneuver	788	-	-	-	-	-
Stage 1	946	-	-	-	-	-
Stage 2	910	-	-	-	-	-

Approach	WB	NB	SB
HCM Control Delay, s	9.1	0	2.7
HCM LOS	A		

Minor Lane/Major Mvmt	NBT	NBRWBLn1	WBLn2	SBL	SBT
Capacity (veh/h)	-	-	788	984	1501
HCM Lane V/C Ratio	-	-	0.008	0.01	0.017
HCM Control Delay (s)	-	-	9.6	8.7	7.4
HCM Lane LOS	-	-	A	A	A
HCM 95th %tile Q(veh)	-	-	0	0	0.1

Intersection												
Int Delay, s/veh	0.1											
Movement	EBL	EBT	EBR	WBL	WBT	WBR	NBL	NBT	NBR	SBL	SBT	SBR
Lane Configurations		↕			↕		↕	↕		↕	↕	
Traffic Vol, veh/h	0	0	0	0	0	0	0	90	2	1	48	0
Future Vol, veh/h	0	0	0	0	0	0	0	90	2	1	48	0
Conflicting Peds, #/hr	0	0	0	0	0	0	0	0	0	0	0	0
Sign Control	Stop	Stop	Stop	Stop	Stop	Stop	Free	Free	Free	Free	Free	Free
RT Channelized	-	-	None	-	-	None	-	-	None	-	-	None
Storage Length	-	-	-	-	-	-	100	-	-	100	-	-
Veh in Median Storage, #	-	0	-	-	0	-	-	0	-	-	0	-
Grade, %	-	0	-	-	0	-	-	0	-	-	0	-
Peak Hour Factor	92	92	92	92	92	92	92	92	92	92	92	92
Heavy Vehicles, %	2	2	2	2	2	2	2	2	2	2	2	2
Mvmt Flow	0	0	0	0	0	0	0	98	2	1	52	0

Major/Minor	Minor2		Minor1		Major1			Major2				
Conflicting Flow All	153	154	52	153	153	99	52	0	0	100	0	0
Stage 1	54	54	-	99	99	-	-	-	-	-	-	-
Stage 2	99	100	-	54	54	-	-	-	-	-	-	-
Critical Hdwy	7.12	6.52	6.22	7.12	6.52	6.22	4.12	-	-	4.12	-	-
Critical Hdwy Stg 1	6.12	5.52	-	6.12	5.52	-	-	-	-	-	-	-
Critical Hdwy Stg 2	6.12	5.52	-	6.12	5.52	-	-	-	-	-	-	-
Follow-up Hdwy	3.518	4.018	3.318	3.518	4.018	3.318	2.218	-	-	2.218	-	-
Pot Cap-1 Maneuver	814	738	1016	814	739	957	1554	-	-	1493	-	-
Stage 1	958	850	-	907	813	-	-	-	-	-	-	-
Stage 2	907	812	-	958	850	-	-	-	-	-	-	-
Platoon blocked, %								-	-	-	-	-
Mov Cap-1 Maneuver	813	737	1016	813	738	957	1554	-	-	1493	-	-
Mov Cap-2 Maneuver	813	737	-	813	738	-	-	-	-	-	-	-
Stage 1	958	849	-	907	813	-	-	-	-	-	-	-
Stage 2	907	812	-	957	849	-	-	-	-	-	-	-

Approach	EB		WB		NB		SB	
HCM Control Delay, s	0		0		0		0.2	
HCM LOS	A		A					

Minor Lane/Major Mvmt	NBL	NBT	NBR	EBLn1WBLn1	SBL	SBT	SBR
Capacity (veh/h)	1554	-	-	-	1493	-	-
HCM Lane V/C Ratio	-	-	-	-	0.001	-	-
HCM Control Delay (s)	0	-	-	0	0	7.4	-
HCM Lane LOS	A	-	-	A	A	A	-
HCM 95th %tile Q(veh)	0	-	-	-	0	-	-

Intersection												
Int Delay, s/veh	0.8											
Movement	EBL	EBT	EBR	WBL	WBT	WBR	NBL	NBT	NBR	SBL	SBT	SBR
Lane Configurations	↶	↷		↶	↷			↕			↕	
Traffic Vol, veh/h	0	113	6	0	123	0	10	0	11	0	0	0
Future Vol, veh/h	0	113	6	0	123	0	10	0	11	0	0	0
Conflicting Peds, #/hr	0	0	0	0	0	0	0	0	0	0	0	0
Sign Control	Free	Free	Free	Free	Free	Free	Stop	Stop	Stop	Stop	Stop	Stop
RT Channelized	-	-	None	-	-	None	-	-	None	-	-	None
Storage Length	100	-	-	100	-	-	-	-	-	-	-	-
Veh in Median Storage, #	-	0	-	-	0	-	-	0	-	-	0	-
Grade, %	-	0	-	-	0	-	-	0	-	-	0	-
Peak Hour Factor	92	92	92	92	92	92	92	92	92	92	92	92
Heavy Vehicles, %	2	2	2	2	2	2	2	2	2	2	2	2
Mvmt Flow	0	123	7	0	134	0	11	0	12	0	0	0

Major/Minor	Major1			Major2			Minor1			Minor2		
Conflicting Flow All	134	0	0	130	0	0	261	261	127	267	264	134
Stage 1	-	-	-	-	-	-	127	127	-	134	134	-
Stage 2	-	-	-	-	-	-	134	134	-	133	130	-
Critical Hdwy	4.12	-	-	4.12	-	-	7.12	6.52	6.22	7.12	6.52	6.22
Critical Hdwy Stg 1	-	-	-	-	-	-	6.12	5.52	-	6.12	5.52	-
Critical Hdwy Stg 2	-	-	-	-	-	-	6.12	5.52	-	6.12	5.52	-
Follow-up Hdwy	2.218	-	-	2.218	-	-	3.518	4.018	3.318	3.518	4.018	3.318
Pot Cap-1 Maneuver	1451	-	-	1455	-	-	692	644	923	686	641	915
Stage 1	-	-	-	-	-	-	877	791	-	869	785	-
Stage 2	-	-	-	-	-	-	869	785	-	870	789	-
Platoon blocked, %	-	-	-	-	-	-	-	-	-	-	-	-
Mov Cap-1 Maneuver	1451	-	-	1455	-	-	692	644	923	677	641	915
Mov Cap-2 Maneuver	-	-	-	-	-	-	692	644	-	677	641	-
Stage 1	-	-	-	-	-	-	877	791	-	869	785	-
Stage 2	-	-	-	-	-	-	869	785	-	859	789	-

Approach	EB			WB			NB			SB		
HCM Control Delay, s	0			0			9.7			0		
HCM LOS							A			A		

Minor Lane/Major Mvmt	NBLn1	EBL	EBT	EBR	WBL	WBT	WBR	SBLn1
Capacity (veh/h)	796	1451	-	-	1455	-	-	-
HCM Lane V/C Ratio	0.029	-	-	-	-	-	-	-
HCM Control Delay (s)	9.7	0	-	-	0	-	-	0
HCM Lane LOS	A	A	-	-	A	-	-	A
HCM 95th %tile Q(veh)	0.1	0	-	-	0	-	-	-

Intersection	
Intersection Delay, s/veh	8.2
Intersection LOS	A

Movement	EBL	EBT	EBR	WBL	WBT	WBR	NBL	NBT	NBR	SBL	SBT	SBR
Lane Configurations	↶	↷		↶	↷		↶	↷		↶	↷	
Traffic Vol, veh/h	39	55	44	29	48	6	28	41	13	5	21	18
Future Vol, veh/h	39	55	44	29	48	6	28	41	13	5	21	18
Peak Hour Factor	0.92	0.92	0.92	0.92	0.92	0.92	0.92	0.92	0.92	0.92	0.92	0.92
Heavy Vehicles, %	2	2	2	2	2	2	2	2	2	2	2	2
Mvmt Flow	42	60	48	32	52	7	30	45	14	5	23	20
Number of Lanes	1	1	0	1	1	0	1	1	0	1	1	0

Approach	EB	WB	NB	SB
Opposing Approach	WB	EB	SB	NB
Opposing Lanes	2	2	2	2
Conflicting Approach Left	SB	NB	EB	WB
Conflicting Lanes Left	2	2	2	2
Conflicting Approach Right	NB	SB	WB	EB
Conflicting Lanes Right	2	2	2	2
HCM Control Delay	8.2	8.2	8.4	8
HCM LOS	A	A	A	A

Lane	NBLn1	NBLn2	EBLn1	EBLn2	WBLn1	WBLn2	SBLn1	SBLn2
Vol Left, %	100%	0%	100%	0%	100%	0%	100%	0%
Vol Thru, %	0%	76%	0%	56%	0%	89%	0%	54%
Vol Right, %	0%	24%	0%	44%	0%	11%	0%	46%
Sign Control	Stop	Stop	Stop	Stop	Stop	Stop	Stop	Stop
Traffic Vol by Lane	28	54	39	99	29	54	5	39
LT Vol	28	0	39	0	29	0	5	0
Through Vol	0	41	0	55	0	48	0	21
RT Vol	0	13	0	44	0	6	0	18
Lane Flow Rate	30	59	42	108	32	59	5	42
Geometry Grp	7	7	7	7	7	7	7	7
Degree of Util (X)	0.048	0.082	0.064	0.139	0.048	0.081	0.009	0.058
Departure Headway (Hd)	5.678	5.006	5.471	4.657	5.521	4.941	5.725	4.898
Convergence, Y/N	Yes	Yes	Yes	Yes	Yes	Yes	Yes	Yes
Cap	632	717	656	770	650	726	627	733
Service Time	3.397	2.725	3.193	2.379	3.244	2.664	3.446	2.619
HCM Lane V/C Ratio	0.047	0.082	0.064	0.14	0.049	0.081	0.008	0.057
HCM Control Delay	8.7	8.2	8.6	8.1	8.5	8.1	8.5	7.9
HCM Lane LOS	A	A	A	A	A	A	A	A
HCM 95th-tile Q	0.2	0.3	0.2	0.5	0.2	0.3	0	0.2

15: 73rd Street/Dial Boulevard & Greenway Hayden Loop

08/17/2022

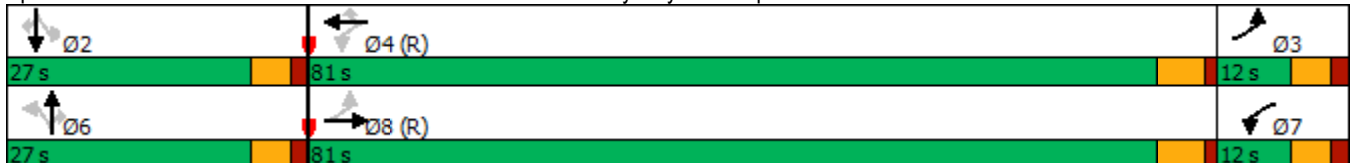


Lane Group	EBL	EBT	WBL	WBT	WBR	NBL	NBT	NBR	SBL	SBT	SBR
Lane Configurations	↘	↑↑↑	↘	↑↑	↗	↘	↑	↗	↘	↑	↗
Traffic Volume (vph)	29	488	189	393	29	35	52	217	75	55	57
Future Volume (vph)	29	488	189	393	29	35	52	217	75	55	57
Turn Type	pm+pt	NA	pm+pt	NA	Perm	Perm	NA	Perm	Perm	NA	Perm
Protected Phases	3	8	7	4			6			2	
Permitted Phases	8		4		4	6		6	2		2
Detector Phase	3	8	7	4	4	6	6	6	2	2	2
Switch Phase											
Minimum Initial (s)	5.0	10.0	5.0	10.0	10.0	7.0	7.0	7.0	7.0	7.0	7.0
Minimum Split (s)	12.0	37.0	37.0	36.0	36.0	37.0	37.0	37.0	37.0	37.0	37.0
Total Split (s)	12.0	81.0	12.0	81.0	81.0	27.0	27.0	27.0	27.0	27.0	27.0
Total Split (%)	10.0%	67.5%	10.0%	67.5%	67.5%	22.5%	22.5%	22.5%	22.5%	22.5%	22.5%
Yellow Time (s)	3.6	4.4	3.6	4.4	4.4	3.6	3.6	3.6	3.6	3.6	3.6
All-Red Time (s)	1.7	1.0	1.7	1.0	1.0	1.6	1.6	1.6	1.6	1.6	1.6
Lost Time Adjust (s)	0.0	0.0	0.0	0.0	0.0	0.0	0.0	0.0	0.0	0.0	0.0
Total Lost Time (s)	5.3	5.4	5.3	5.4	5.4	5.2	5.2	5.2	5.2	5.2	5.2
Lead/Lag	Lag	Lead	Lag	Lead	Lead						
Lead-Lag Optimize?	Yes	Yes	Yes	Yes	Yes						
Recall Mode	Max	C-Min	None	C-Min	C-Min	None	None	None	None	None	None
Act Effct Green (s)	91.4	27.7	93.2	28.5	28.5	11.9	11.9	11.9	11.9	11.9	11.9
Actuated g/C Ratio	0.76	0.23	0.78	0.24	0.24	0.10	0.10	0.10	0.10	0.10	0.10
v/c Ratio	0.03	0.49	0.19	0.51	0.07	0.29	0.31	0.64	0.62	0.33	0.28
Control Delay	3.7	45.9	10.5	23.1	2.2	54.0	53.1	14.4	70.7	53.5	12.3
Queue Delay	0.0	0.0	0.0	0.0	0.0	0.0	0.0	0.0	0.0	0.0	0.0
Total Delay	3.7	45.9	10.5	23.1	2.2	54.0	53.1	14.4	70.7	53.5	12.3
LOS	A	D	B	C	A	D	D	B	E	D	B
Approach Delay		43.7		18.2			25.6			47.9	
Approach LOS		D		B			C			D	

Intersection Summary

Cycle Length: 120
 Actuated Cycle Length: 120
 Offset: 47 (39%), Referenced to phase 4:WBTL and 8:EBTL, Start of Green
 Natural Cycle: 115
 Control Type: Actuated-Coordinated
 Maximum v/c Ratio: 0.64
 Intersection Signal Delay: 31.5
 Intersection Capacity Utilization 45.0%
 Analysis Period (min) 15
 Intersection LOS: C
 ICU Level of Service A

Splits and Phases: 15: 73rd Street/Dial Boulevard & Greenway Hayden Loop



15: 73rd Street/Dial Boulevard & Greenway Hayden Loop

08/17/2022



Movement	EBL	EBT	EBR	WBL	WBT	WBR	NBL	NBT	NBR	SBL	SBT	SBR
Lane Configurations	↖	↕↕↕		↖	↕↕	↖	↖	↕	↖	↖	↕	↖
Traffic Volume (veh/h)	29	488	46	189	393	29	35	52	217	75	55	57
Future Volume (veh/h)	29	488	46	189	393	29	35	52	217	75	55	57
Initial Q (Qb), veh	0	0	0	0	0	0	0	0	0	0	0	0
Ped-Bike Adj(A_pbT)	1.00		1.00	1.00		1.00	1.00		1.00	1.00		1.00
Parking Bus, Adj	1.00	1.00	1.00	1.00	1.00	1.00	1.00	1.00	1.00	1.00	1.00	1.00
Work Zone On Approach		No			No			No			No	
Adj Sat Flow, veh/h/ln	1870	1870	1870	1870	1870	1870	1870	1870	1870	1870	1870	1870
Adj Flow Rate, veh/h	32	530	50	205	427	32	38	57	236	82	60	62
Peak Hour Factor	0.92	0.92	0.92	0.92	0.92	0.92	0.92	0.92	0.92	0.92	0.92	0.92
Percent Heavy Veh, %	2	2	2	2	2	2	2	2	2	2	2	2
Cap, veh/h	1077	714	67	1077	533	238	233	307	261	210	307	261
Arrive On Green	0.18	0.05	0.05	0.55	0.15	0.15	0.16	0.16	0.16	0.16	0.16	0.16
Sat Flow, veh/h	1781	4751	443	1781	3554	1585	1269	1870	1585	1086	1870	1585
Grp Volume(v), veh/h	32	378	202	205	427	32	38	57	236	82	60	62
Grp Sat Flow(s),veh/h/ln	1781	1702	1791	1781	1777	1585	1269	1870	1585	1086	1870	1585
Q Serve(g_s), s	0.0	13.1	13.4	0.0	13.9	2.1	3.2	3.2	17.5	8.4	3.3	4.1
Cycle Q Clear(g_c), s	0.0	13.1	13.4	0.0	13.9	2.1	6.5	3.2	17.5	11.6	3.3	4.1
Prop In Lane	1.00		0.25	1.00		1.00	1.00		1.00	1.00		1.00
Lane Grp Cap(c), veh/h	1077	512	269	1077	533	238	233	307	261	210	307	261
V/C Ratio(X)	0.03	0.74	0.75	0.19	0.80	0.13	0.16	0.19	0.91	0.39	0.20	0.24
Avail Cap(c_a), veh/h	1077	2145	1128	1077	2239	999	255	340	288	229	340	288
HCM Platoon Ratio	0.33	0.33	0.33	1.00	1.00	1.00	1.00	1.00	1.00	1.00	1.00	1.00
Upstream Filter(I)	0.90	0.90	0.90	1.00	1.00	1.00	1.00	1.00	1.00	1.00	1.00	1.00
Uniform Delay (d), s/veh	20.0	54.7	54.8	11.6	49.3	44.2	46.1	43.2	49.2	48.2	43.3	43.6
Incr Delay (d2), s/veh	0.0	8.4	15.9	0.0	12.0	1.2	0.1	0.1	27.1	0.4	0.1	0.2
Initial Q Delay(d3),s/veh	0.0	0.0	0.0	0.0	0.0	0.0	0.0	0.0	0.0	0.0	0.0	0.0
%ile BackOfQ(50%),veh/ln	0.7	6.6	7.6	2.5	7.1	0.9	1.0	1.5	8.9	2.3	1.6	1.6
Unsig. Movement Delay, s/veh												
LnGrp Delay(d),s/veh	20.0	63.1	70.7	11.7	61.2	45.4	46.2	43.3	76.3	48.7	43.4	43.8
LnGrp LOS	C	E	E	B	E	D	D	D	E	D	D	D
Approach Vol, veh/h		612			664			331			204	
Approach Delay, s/veh		63.3			45.2			67.2			45.6	
Approach LOS		E			D			E			D	
Timer - Assigned Phs		2	3	4		6	7	8				
Phs Duration (G+Y+Rc), s		24.9	71.7	23.4		24.9	71.6	23.4				
Change Period (Y+Rc), s		* 5.2	5.3	* 5.4		* 5.2	5.3	* 5.4				
Max Green Setting (Gmax), s		* 22	6.7	* 76		* 22	6.7	* 76				
Max Q Clear Time (g_c+I1), s		13.6	2.0	15.9		19.5	2.0	15.4				
Green Ext Time (p_c), s		0.3	0.0	2.1		0.2	0.1	2.7				

Intersection Summary

HCM 6th Ctrl Delay	55.4
HCM 6th LOS	E

Notes

User approved pedestrian interval to be less than phase max green.
 * HCM 6th computational engine requires equal clearance times for the phases crossing the barrier.

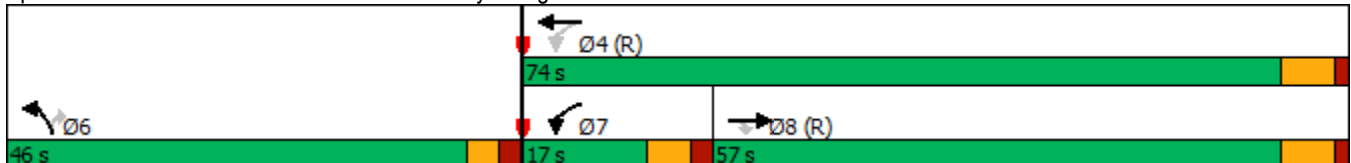


Lane Group	EBT	EBR	WBL	WBT	NBL	NBR
Lane Configurations	↑↑↑	↑	↓	↑↑↑	↓	↓
Traffic Volume (vph)	1365	94	178	816	42	111
Future Volume (vph)	1365	94	178	816	42	111
Turn Type	NA	Perm	pm+pt	NA	Prot	Perm
Protected Phases	8		7	4	6	
Permitted Phases		8	4			6
Detector Phase	8	8	7	4	6	6
Switch Phase						
Minimum Initial (s)	7.0	7.0	5.0	10.0	7.0	7.0
Minimum Split (s)	13.2	13.2	11.0	16.2	12.0	12.0
Total Split (s)	57.0	57.0	17.0	74.0	46.0	46.0
Total Split (%)	47.5%	47.5%	14.2%	61.7%	38.3%	38.3%
Yellow Time (s)	4.7	4.7	4.0	4.7	3.0	3.0
All-Red Time (s)	1.5	1.5	1.9	1.5	2.0	2.0
Lost Time Adjust (s)	0.0	0.0	0.0	0.0	0.0	0.0
Total Lost Time (s)	6.2	6.2	5.9	6.2	5.0	5.0
Lead/Lag	Lag	Lag	Lead			
Lead-Lag Optimize?	Yes	Yes	Yes			
Recall Mode	C-Min	C-Min	None	C-Min	None	None
Act Effct Green (s)	85.8	85.8	101.3	101.0	7.8	7.8
Actuated g/C Ratio	0.72	0.72	0.84	0.84	0.06	0.06
v/c Ratio	0.41	0.09	0.57	0.21	0.21	0.56
Control Delay	2.8	1.9	29.7	1.2	54.9	19.8
Queue Delay	0.0	0.0	0.0	0.0	0.0	0.0
Total Delay	2.8	1.9	29.7	1.2	54.9	19.8
LOS	A	A	C	A	D	B
Approach Delay	2.7			6.3	29.5	
Approach LOS	A			A	C	

Intersection Summary

Cycle Length: 120
 Actuated Cycle Length: 120
 Offset: 75 (63%), Referenced to phase 4:WBTL and 8:EBT, Start of 1st Green
 Natural Cycle: 55
 Control Type: Actuated-Coordinated
 Maximum v/c Ratio: 0.57
 Intersection Signal Delay: 5.6
 Intersection Capacity Utilization 56.3%
 Analysis Period (min) 15
 Intersection LOS: A
 ICU Level of Service B

Splits and Phases: 16: 76th Street & Frank Lloyd Wright Boulevard





Movement	EBT	EBR	WBL	WBT	NBL	NBR	
Lane Configurations	↑↑↑	↑	↓	↑↑↑	↓	↑	
Traffic Volume (veh/h)	1365	94	178	816	42	111	
Future Volume (veh/h)	1365	94	178	816	42	111	
Initial Q (Qb), veh	0	0	0	0	0	0	
Ped-Bike Adj(A_pbT)		1.00	1.00		1.00	1.00	
Parking Bus, Adj	1.00	1.00	1.00	1.00	1.00	1.00	
Work Zone On Approach	No			No	No		
Adj Sat Flow, veh/h/ln	1870	1870	1870	1870	1870	1870	
Adj Flow Rate, veh/h	1484	102	193	887	46	121	
Peak Hour Factor	0.92	0.92	0.92	0.92	0.92	0.92	
Percent Heavy Veh, %	2	2	2	2	2	2	
Cap, veh/h	3667	1138	294	4151	324	148	
Arrive On Green	0.24	0.24	0.09	1.00	0.09	0.09	
Sat Flow, veh/h	5274	1585	1781	5274	3456	1585	
Grp Volume(v), veh/h	1484	102	193	887	46	121	
Grp Sat Flow(s),veh/h/ln	1702	1585	1781	1702	1728	1585	
Q Serve(g_s), s	29.4	6.0	3.5	0.0	1.5	9.0	
Cycle Q Clear(g_c), s	29.4	6.0	3.5	0.0	1.5	9.0	
Prop In Lane		1.00	1.00		1.00	1.00	
Lane Grp Cap(c), veh/h	3667	1138	294	4151	324	148	
V/C Ratio(X)	0.40	0.09	0.66	0.21	0.14	0.82	
Avail Cap(c_a), veh/h	3667	1138	377	4151	1181	542	
HCM Platoon Ratio	0.33	0.33	2.00	2.00	1.00	1.00	
Upstream Filter(I)	0.62	0.62	0.91	0.91	1.00	1.00	
Uniform Delay (d), s/veh	24.1	15.2	12.2	0.0	50.0	53.4	
Incr Delay (d2), s/veh	0.2	0.1	1.1	0.1	0.1	4.1	
Initial Q Delay(d3),s/veh	0.0	0.0	0.0	0.0	0.0	0.0	
%ile BackOfQ(50%),veh/ln	13.4	2.0	2.3	0.0	0.6	7.9	
Unsig. Movement Delay, s/veh							
LnGrp Delay(d),s/veh	24.3	15.3	13.3	0.1	50.0	57.5	
LnGrp LOS	C	B	B	A	D	E	
Approach Vol, veh/h	1586			1080	167		
Approach Delay, s/veh	23.8			2.5	55.4		
Approach LOS	C			A	E		
Timer - Assigned Phs				4	6	7	8
Phs Duration (G+Y+Rc), s				103.8	16.2	11.4	92.4
Change Period (Y+Rc), s				6.2	5.0	* 5.9	6.2
Max Green Setting (Gmax), s				67.8	41.0	* 11	50.8
Max Q Clear Time (g_c+I1), s				2.0	11.0	5.5	31.4
Green Ext Time (p_c), s				1.1	0.3	0.0	1.9

Intersection Summary

HCM 6th Ctrl Delay	17.5
HCM 6th LOS	B

Notes

User approved pedestrian interval to be less than phase max green.
 * HCM 6th computational engine requires equal clearance times for the phases crossing the barrier.

Intersection

Intersection Delay, s/veh	9
Intersection LOS	A

Movement	EBL	EBT	EBR	WBL	WBT	WBR	NBL	NBT	NBR	SBL	SBT	SBR
Lane Configurations												
Traffic Vol, veh/h	33	81	43	18	44	22	3	64	9	28	111	32
Future Vol, veh/h	33	81	43	18	44	22	3	64	9	28	111	32
Peak Hour Factor	0.92	0.92	0.92	0.92	0.92	0.92	0.92	0.92	0.92	0.92	0.92	0.92
Heavy Vehicles, %	2	2	2	2	2	2	2	2	2	2	2	2
Mvmt Flow	36	88	47	20	48	24	3	70	10	30	121	35
Number of Lanes	1	1	0	1	1	0	1	1	0	1	1	0

Approach	EB	WB	NB	SB
Opposing Approach	WB	EB	SB	NB
Opposing Lanes	2	2	2	2
Conflicting Approach Left	SB	NB	EB	WB
Conflicting Lanes Left	2	2	2	2
Conflicting Approach Right	NB	SB	WB	EB
Conflicting Lanes Right	2	2	2	2
HCM Control Delay	9	8.6	8.8	9.2
HCM LOS	A	A	A	A

Lane	NBLn1	NBLn2	EBLn1	EBLn2	WBLn1	WBLn2	SBLn1	SBLn2
Vol Left, %	100%	0%	100%	0%	100%	0%	100%	0%
Vol Thru, %	0%	88%	0%	65%	0%	67%	0%	78%
Vol Right, %	0%	12%	0%	35%	0%	33%	0%	22%
Sign Control	Stop	Stop	Stop	Stop	Stop	Stop	Stop	Stop
Traffic Vol by Lane	3	73	33	124	18	66	28	143
LT Vol	3	0	33	0	18	0	28	0
Through Vol	0	64	0	81	0	44	0	111
RT Vol	0	9	0	43	0	22	0	32
Lane Flow Rate	3	79	36	135	20	72	30	155
Geometry Grp	7	7	7	7	7	7	7	7
Degree of Util (X)	0.005	0.117	0.058	0.19	0.032	0.103	0.049	0.222
Departure Headway (Hd)	5.906	5.316	5.826	5.079	5.913	5.175	5.792	5.132
Convergence, Y/N	Yes	Yes	Yes	Yes	Yes	Yes	Yes	Yes
Cap	604	672	614	705	604	690	617	698
Service Time	3.658	3.067	3.571	2.824	3.664	2.926	3.536	2.876
HCM Lane V/C Ratio	0.005	0.118	0.059	0.191	0.033	0.104	0.049	0.222
HCM Control Delay	8.7	8.8	8.9	9	8.9	8.5	8.8	9.3
HCM Lane LOS	A	A	A	A	A	A	A	A
HCM 95th-tile Q	0	0.4	0.2	0.7	0.1	0.3	0.2	0.8

18: Greenway Hayden Loop & Frank Lloyd Wright Boulevard

08/17/2022

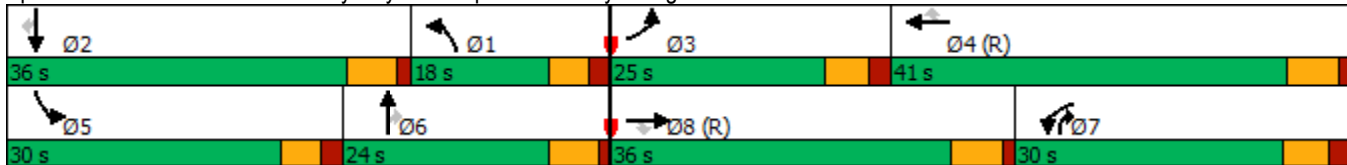


Lane Group	EBL	EBT	EBR	WBL	WBT	WBR	NBL	NBT	NBR	SBL	SBT	SBR
Lane Configurations	↖↗	↑↑↑	↖	↖↗	↑↑↑	↖	↖	↑↑	↖	↖↗	↑↑	↖
Traffic Volume (vph)	284	1086	55	512	879	152	12	330	354	213	545	234
Future Volume (vph)	284	1086	55	512	879	152	12	330	354	213	545	234
Turn Type	Prot	NA	Perm	Prot	NA	Perm	Prot	NA	pm+ov	Prot	NA	Perm
Protected Phases	3	8		7	4		1	6	7	5	2	
Permitted Phases			8			4			6			2
Detector Phase	3	8	8	7	4	4	1	6	7	5	2	2
Switch Phase												
Minimum Initial (s)	5.0	10.0	10.0	5.0	10.0	10.0	5.0	7.0	5.0	5.0	7.0	7.0
Minimum Split (s)	11.0	15.9	15.9	11.0	15.9	15.9	11.0	13.0	11.0	11.0	13.0	13.0
Total Split (s)	25.0	36.0	36.0	30.0	41.0	41.0	18.0	24.0	30.0	30.0	36.0	36.0
Total Split (%)	20.8%	30.0%	30.0%	25.0%	34.2%	34.2%	15.0%	20.0%	25.0%	25.0%	30.0%	30.0%
Yellow Time (s)	4.0	4.7	4.7	4.0	4.7	4.7	3.6	4.4	4.0	3.6	4.4	4.4
All-Red Time (s)	2.0	1.0	1.0	2.0	1.0	1.0	2.0	1.2	2.0	2.0	1.2	1.2
Lost Time Adjust (s)	0.0	0.0	0.0	0.0	0.0	0.0	0.0	0.0	0.0	0.0	0.0	0.0
Total Lost Time (s)	6.0	5.7	5.7	6.0	5.7	5.7	5.6	5.6	6.0	5.6	5.6	5.6
Lead/Lag	Lead	Lead	Lead	Lag	Lag	Lag	Lag	Lag	Lag	Lead	Lead	Lead
Lead-Lag Optimize?	Yes	Yes	Yes	Yes	Yes	Yes	Yes	Yes	Yes	Yes	Yes	Yes
Recall Mode	None	C-Min	C-Min	None	C-Min	C-Min	None	None	None	None	None	None
Act Effct Green (s)	14.2	47.0	47.0	21.9	54.7	54.7	5.9	15.7	37.2	12.5	28.8	28.8
Actuated g/C Ratio	0.12	0.39	0.39	0.18	0.46	0.46	0.05	0.13	0.31	0.10	0.24	0.24
v/c Ratio	0.76	0.59	0.08	0.89	0.41	0.20	0.15	0.78	0.66	0.65	0.70	0.44
Control Delay	73.1	36.7	1.2	65.2	24.1	3.6	30.2	39.2	28.5	60.1	46.7	7.2
Queue Delay	0.0	0.0	0.0	0.0	0.0	0.0	0.0	0.0	0.0	0.0	0.0	0.0
Total Delay	73.1	36.7	1.2	65.2	24.1	3.6	30.2	39.2	28.5	60.1	46.7	7.2
LOS	E	D	A	E	C	A	C	D	C	E	D	A
Approach Delay		42.6			35.7			33.6			40.3	
Approach LOS		D			D			C			D	

Intersection Summary

Cycle Length: 120
 Actuated Cycle Length: 120
 Offset: 93 (78%), Referenced to phase 4:WBT and 8:EBT, Start of 1st Green
 Natural Cycle: 80
 Control Type: Actuated-Coordinated
 Maximum v/c Ratio: 0.89
 Intersection Signal Delay: 38.5
 Intersection LOS: D
 Intersection Capacity Utilization 73.9%
 ICU Level of Service D
 Analysis Period (min) 15

Splits and Phases: 18: Greenway Hayden Loop & Frank Lloyd Wright Boulevard



18: Greenway Hayden Loop & Frank Lloyd Wright Boulevard

08/17/2022



Movement	EBL	EBT	EBR	WBL	WBT	WBR	NBL	NBT	NBR	SBL	SBT	SBR
Lane Configurations	↔↔	↑↑↑	↔	↔↔	↑↑↑	↔	↔	↑↑	↔	↔↔	↑↑	↔
Traffic Volume (veh/h)	284	1086	55	512	879	152	12	330	354	213	545	234
Future Volume (veh/h)	284	1086	55	512	879	152	12	330	354	213	545	234
Initial Q (Qb), veh	0	0	0	0	0	0	0	0	0	0	0	0
Ped-Bike Adj(A_pbT)	1.00		1.00	1.00		1.00	1.00		1.00	1.00		1.00
Parking Bus, Adj	1.00	1.00	1.00	1.00	1.00	1.00	1.00	1.00	1.00	1.00	1.00	1.00
Work Zone On Approach		No			No			No			No	
Adj Sat Flow, veh/h/ln	1870	1870	1870	1870	1870	1870	1870	1870	1870	1870	1870	1870
Adj Flow Rate, veh/h	309	1180	60	557	955	165	13	359	385	232	592	254
Peak Hour Factor	0.92	0.92	0.92	0.92	0.92	0.92	0.92	0.92	0.92	0.92	0.92	0.92
Percent Heavy Veh, %	2	2	2	2	2	2	2	2	2	2	2	2
Cap, veh/h	359	1244	386	1244	2538	788	30	428	761	295	670	299
Arrive On Green	0.21	0.49	0.49	0.36	0.50	0.50	0.02	0.12	0.12	0.09	0.19	0.19
Sat Flow, veh/h	3456	5106	1585	3456	5106	1585	1781	3554	1585	3456	3554	1585
Grp Volume(v), veh/h	309	1180	60	557	955	165	13	359	385	232	592	254
Grp Sat Flow(s),veh/h/ln	1728	1702	1585	1728	1702	1585	1781	1777	1585	1728	1777	1585
Q Serve(g_s), s	10.3	26.4	2.5	14.8	13.9	7.0	0.9	11.9	5.1	7.9	19.5	14.0
Cycle Q Clear(g_c), s	10.3	26.4	2.5	14.8	13.9	7.0	0.9	11.9	5.1	7.9	19.5	14.0
Prop In Lane	1.00		1.00	1.00		1.00	1.00		1.00	1.00		1.00
Lane Grp Cap(c), veh/h	359	1244	386	1244	2538	788	30	428	761	295	670	299
V/C Ratio(X)	0.86	0.95	0.16	0.45	0.38	0.21	0.43	0.84	0.51	0.79	0.88	0.85
Avail Cap(c_a), veh/h	547	1289	400	1244	2538	788	184	545	814	703	900	402
HCM Platoon Ratio	2.00	2.00	2.00	1.00	1.00	1.00	1.00	1.00	1.00	1.00	1.00	1.00
Upstream Filter(I)	0.91	0.91	0.91	1.00	1.00	1.00	1.00	1.00	1.00	1.00	1.00	1.00
Uniform Delay (d), s/veh	46.7	30.1	23.9	29.3	18.7	16.9	58.4	51.6	8.1	53.8	47.4	26.6
Incr Delay (d2), s/veh	5.1	14.8	0.8	0.1	0.4	0.6	3.6	7.4	0.2	1.8	6.7	9.6
Initial Q Delay(d3),s/veh	0.0	0.0	0.0	0.0	0.0	0.0	0.0	0.0	0.0	0.0	0.0	0.0
%ile BackOfQ(50%),veh/ln	4.2	9.0	1.0	5.9	5.3	2.6	0.4	5.6	3.2	3.4	9.0	5.9
Unsig. Movement Delay, s/veh												
LnGrp Delay(d),s/veh	51.8	44.9	24.7	29.4	19.1	17.5	62.0	59.1	8.3	55.6	54.1	36.3
LnGrp LOS	D	D	C	C	B	B	E	E	A	E	D	D
Approach Vol, veh/h		1549			1677			757			1078	
Approach Delay, s/veh		45.5			22.4			33.3			50.2	
Approach LOS		D			C			C			D	
Timer - Assigned Phs	1	2	3	4	5	6	7	8				
Phs Duration (G+Y+Rc), s	7.6	28.2	18.5	65.6	15.8	20.0	49.2	34.9				
Change Period (Y+Rc), s	* 5.6	5.6	6.0	* 6	5.6	* 5.6	6.0	5.7				
Max Green Setting (Gmax), s	* 12	30.4	19.0	* 35	24.4	* 18	24.0	30.3				
Max Q Clear Time (g_c+I1), s	2.9	21.5	12.3	15.9	9.9	13.9	16.8	28.4				
Green Ext Time (p_c), s	0.0	1.2	0.1	2.3	0.3	0.6	0.3	0.8				

Intersection Summary

HCM 6th Ctrl Delay	37.0
HCM 6th LOS	D

Notes

User approved pedestrian interval to be less than phase max green.
 * HCM 6th computational engine requires equal clearance times for the phases crossing the barrier.

Intersection												
Int Delay, s/veh	1											
Movement	EBL	EBT	EBR	WBL	WBT	WBR	NBL	NBT	NBR	SBL	SBT	SBR
Lane Configurations		↕	↗		↕	↗	↖	↕	↗	↖	↕	↗
Traffic Vol, veh/h	6	6	14	12	4	24	15	666	31	51	973	67
Future Vol, veh/h	6	6	14	12	4	24	15	666	31	51	973	67
Conflicting Peds, #/hr	0	0	0	0	0	0	0	0	0	0	0	0
Sign Control	Stop	Stop	Stop	Stop	Stop	Stop	Free	Free	Free	Free	Free	Free
RT Channelized	-	-	None	-	-	None	-	-	None	-	-	None
Storage Length	-	-	130	-	-	130	150	-	-	110	-	175
Veh in Median Storage, #	-	0	-	-	0	-	-	0	-	-	0	-
Grade, %	-	0	-	-	0	-	-	0	-	-	0	-
Peak Hour Factor	92	92	92	92	92	92	92	92	92	92	92	92
Heavy Vehicles, %	2	2	2	2	2	2	2	2	2	2	2	2
Mvmt Flow	7	7	15	13	4	26	16	724	34	55	1058	73

Major/Minor	Minor2		Minor1		Major1			Major2				
Conflicting Flow All	1564	1958	529	1399	1997	362	1131	0	0	758	0	0
Stage 1	1168	1168	-	756	756	-	-	-	-	-	-	-
Stage 2	396	790	-	643	1241	-	-	-	-	-	-	-
Critical Hdwy	7.54	6.54	6.94	7.54	6.54	6.94	4.14	-	-	4.14	-	-
Critical Hdwy Stg 1	6.54	5.54	-	6.54	5.54	-	-	-	-	-	-	-
Critical Hdwy Stg 2	6.54	5.54	-	6.54	5.54	-	-	-	-	-	-	-
Follow-up Hdwy	3.52	4.02	3.32	3.52	4.02	3.32	2.22	-	-	2.22	-	-
Pot Cap-1 Maneuver	197	94	*685	*303	87	635	988	-	-	849	-	-
Stage 1	564	512	-	*366	414	-	-	-	-	-	-	-
Stage 2	601	400	-	*645	456	-	-	-	-	-	-	-
Platoon blocked, %	1	1	1	1	1	1	1	-	-	-	-	-
Mov Cap-1 Maneuver	170	87	*685	*262	80	635	988	-	-	849	-	-
Mov Cap-2 Maneuver	170	87	-	*262	80	-	-	-	-	-	-	-
Stage 1	555	479	-	*360	407	-	-	-	-	-	-	-
Stage 2	561	394	-	*582	427	-	-	-	-	-	-	-

Approach	EB		WB		NB		SB	
HCM Control Delay, s	24.2		18.1		0.2		0.4	
HCM LOS	C		C					

Minor Lane/Major Mvmt	NBL	NBT	NBR	EBLn1	EBLn2	WBLn1	WBLn2	SBL	SBT	SBR
Capacity (veh/h)	988	-	-	115	685	167	635	849	-	-
HCM Lane V/C Ratio	0.017	-	-	0.113	0.022	0.104	0.041	0.065	-	-
HCM Control Delay (s)	8.7	-	-	40.3	10.4	29	10.9	9.5	-	-
HCM Lane LOS	A	-	-	E	B	D	B	A	-	-
HCM 95th %tile Q(veh)	0.1	-	-	0.4	0.1	0.3	0.1	0.2	-	-

Notes
 ~: Volume exceeds capacity \$: Delay exceeds 300s +: Computation Not Defined *: All major volume in platoon

1: Scottsdale Road & Bell Road/Frank Lloyd Wright Boulevard

08/17/2022



Movement	EBL	EBT	EBR	WBL	WBT	WBR	NBL	NBT	NBR	SBL	SBT	SBR
Lane Configurations	↔↔	↑↑↑	↔	↔↔	↑↑↑	↔	↔↔	↑↑↑	↔	↔↔	↑↑↑	↔
Traffic Volume (veh/h)	297	635	177	143	982	523	278	1275	185	375	1027	291
Future Volume (veh/h)	297	635	177	143	982	523	278	1275	185	375	1027	291
Initial Q (Qb), veh	0	0	0	0	0	0	0	0	0	0	0	0
Ped-Bike Adj(A_pbT)	1.00		1.00	1.00		1.00	1.00		1.00	1.00		1.00
Parking Bus, Adj	1.00	1.00	1.00	1.00	1.00	1.00	1.00	1.00	1.00	1.00	1.00	1.00
Work Zone On Approach		No			No			No			No	
Adj Sat Flow, veh/h/ln	1870	1870	1870	1870	1870	1870	1870	1870	1870	1870	1870	1870
Adj Flow Rate, veh/h	323	690	192	155	1067	568	302	1386	201	408	1116	316
Peak Hour Factor	0.92	0.92	0.92	0.92	0.92	0.92	0.92	0.92	0.92	0.92	0.92	0.92
Percent Heavy Veh, %	2	2	2	2	2	2	2	2	2	2	2	2
Cap, veh/h	317	1422	441	213	1277	676	367	1455	452	610	1399	396
Arrive On Green	0.09	0.28	0.28	0.02	0.08	0.08	0.04	0.09	0.09	0.18	0.35	0.35
Sat Flow, veh/h	3456	5106	1585	3456	5106	1585	3456	5106	1585	3456	3954	1119
Grp Volume(v), veh/h	323	690	192	155	1067	568	302	1386	201	408	961	471
Grp Sat Flow(s),veh/h/ln	1728	1702	1585	1728	1702	1585	1728	1702	1585	1728	1702	1669
Q Serve(g_s), s	11.0	13.5	11.9	5.4	24.7	20.7	10.4	32.4	11.2	13.2	30.5	30.5
Cycle Q Clear(g_c), s	11.0	13.5	11.9	5.4	24.7	20.7	10.4	32.4	11.2	13.2	30.5	30.5
Prop In Lane	1.00		1.00	1.00		1.00	1.00		1.00	1.00		0.67
Lane Grp Cap(c), veh/h	317	1422	441	213	1277	676	367	1455	452	610	1204	590
V/C Ratio(X)	1.02	0.49	0.43	0.73	0.84	0.84	0.82	0.95	0.44	0.67	0.80	0.80
Avail Cap(c_a), veh/h	317	1422	441	317	1413	718	547	1455	452	610	1204	590
HCM Platoon Ratio	1.00	1.00	1.00	0.33	0.33	0.33	0.33	0.33	0.33	1.00	1.00	1.00
Upstream Filter(I)	1.00	1.00	1.00	0.92	0.92	0.92	0.86	0.86	0.86	1.00	1.00	1.00
Uniform Delay (d), s/veh	54.5	36.1	35.5	57.8	52.6	40.5	56.8	53.5	27.4	46.1	34.9	34.9
Incr Delay (d2), s/veh	55.7	0.1	0.3	1.7	3.5	7.2	3.3	13.2	2.7	2.3	5.6	10.8
Initial Q Delay(d3),s/veh	0.0	0.0	0.0	0.0	0.0	0.0	0.0	0.0	0.0	0.0	0.0	0.0
%ile BackOfQ(50%),veh/ln	7.1	5.5	4.5	2.4	11.6	9.7	4.9	16.5	4.9	5.7	13.0	13.6
Unsig. Movement Delay, s/veh												
LnGrp Delay(d),s/veh	110.2	36.2	35.8	59.4	56.1	47.6	60.1	66.7	30.1	48.4	40.5	45.7
LnGrp LOS	F	D	D	E	E	D	E	E	C	D	D	D
Approach Vol, veh/h		1205			1790			1889			1840	
Approach Delay, s/veh		56.0			53.7			61.8			43.6	
Approach LOS		E			D			E			D	
Timer - Assigned Phs	1	2	3	4	5	6	7	8				
Phs Duration (G+Y+Rc), s	18.7	48.4	17.0	35.8	27.2	40.0	13.4	39.4				
Change Period (Y+Rc), s	6.0	* 6	* 6	5.8	* 6	5.8	6.0	* 6				
Max Green Setting (Gmax), s	19.0	* 33	* 11	33.2	* 18	34.2	11.0	* 33				
Max Q Clear Time (g_c+I1), s	12.4	32.5	13.0	26.7	15.2	34.4	7.4	15.5				
Green Ext Time (p_c), s	0.3	0.4	0.0	3.3	0.3	0.0	0.1	1.6				

Intersection Summary

HCM 6th Ctrl Delay	53.6
HCM 6th LOS	D

Notes

User approved pedestrian interval to be less than phase max green.
 * HCM 6th computational engine requires equal clearance times for the phases crossing the barrier.

2: Scottsdale Road & Paradise Lane

08/17/2022

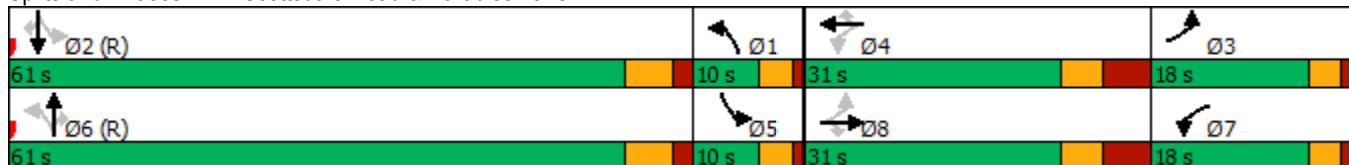


Lane Group	EBL	EBT	EBR	WBL	WBT	WBR	NBL	NBT	NBR	SBL	SBT	SBR
Lane Configurations	↘	↑	↗	↘	↑	↗	↘	↑↑↑	↗	↘	↑↑↑	↗
Traffic Volume (vph)	99	26	17	130	28	165	12	1450	68	53	1209	25
Future Volume (vph)	99	26	17	130	28	165	12	1450	68	53	1209	25
Turn Type	pm+pt	NA	Perm	pm+pt	NA	Perm	pm+pt	NA	Perm	pm+pt	NA	Perm
Protected Phases	3	8		7	4		1	6		5	2	
Permitted Phases	8		8	4		4	6		6	2		2
Detector Phase	3	8	8	7	4	4	1	6	6	5	2	2
Switch Phase												
Minimum Initial (s)	4.0	7.0	7.0	4.0	7.0	7.0	4.0	10.0	10.0	4.0	10.0	10.0
Minimum Split (s)	10.0	15.0	15.0	11.0	15.0	15.0	11.0	16.0	16.0	11.0	16.0	16.0
Total Split (s)	18.0	31.0	31.0	18.0	31.0	31.0	10.0	61.0	61.0	10.0	61.0	61.0
Total Split (%)	15.0%	25.8%	25.8%	15.0%	25.8%	25.8%	8.3%	50.8%	50.8%	8.3%	50.8%	50.8%
Yellow Time (s)	3.0	3.7	3.7	3.0	3.7	3.7	3.0	4.3	4.3	3.0	4.3	4.3
All-Red Time (s)	1.0	4.3	4.3	1.0	4.3	4.3	1.0	1.7	1.7	1.0	1.7	1.7
Lost Time Adjust (s)	0.0	0.0	0.0	0.0	0.0	0.0	0.0	0.0	0.0	0.0	0.0	0.0
Total Lost Time (s)	4.0	8.0	8.0	4.0	8.0	8.0	4.0	6.0	6.0	4.0	6.0	6.0
Lead/Lag	Lag	Lead	Lead	Lag	Lead	Lead	Lag	Lead	Lead	Lag	Lead	Lead
Lead-Lag Optimize?	Yes	Yes	Yes	Yes	Yes	Yes	Yes	Yes	Yes	Yes	Yes	Yes
Recall Mode	None	None	None	None	None	None	None	C-Min	C-Min	None	C-Min	C-Min
Act Effct Green (s)	13.7	7.4	7.4	21.4	8.2	8.2	84.4	78.1	78.1	88.5	83.8	83.8
Actuated g/C Ratio	0.11	0.06	0.06	0.18	0.07	0.07	0.70	0.65	0.65	0.74	0.70	0.70
v/c Ratio	0.56	0.25	0.09	0.49	0.24	0.65	0.04	0.48	0.07	0.24	0.37	0.02
Control Delay	56.3	59.0	1.0	49.9	56.5	19.2	4.8	12.4	0.7	6.0	5.1	0.0
Queue Delay	0.0	0.0	0.0	0.0	0.0	0.0	0.0	0.0	0.0	0.0	0.0	0.0
Total Delay	56.3	59.0	1.0	49.9	56.5	19.2	4.8	12.4	0.7	6.0	5.1	0.0
LOS	E	E	A	D	E	B	A	B	A	A	A	A
Approach Delay		50.3			34.7			11.8			5.1	
Approach LOS		D			C			B			A	

Intersection Summary

Cycle Length: 120
 Actuated Cycle Length: 120
 Offset: 49 (41%), Referenced to phase 2:SBTL and 6:NBTL, Start of 1st Green
 Natural Cycle: 60
 Control Type: Actuated-Coordinated
 Maximum v/c Ratio: 0.65
 Intersection Signal Delay: 13.1
 Intersection LOS: B
 Intersection Capacity Utilization 60.2%
 ICU Level of Service B
 Analysis Period (min) 15

Splits and Phases: 2: Scottsdale Road & Paradise Lane



2: Scottsdale Road & Paradise Lane

08/17/2022



Movement	EBL	EBT	EBR	WBL	WBT	WBR	NBL	NBT	NBR	SBL	SBT	SBR
Lane Configurations	↘	↑	↗	↘	↑	↗	↘	↑↑↑	↗	↘	↑↑↑	↗
Traffic Volume (veh/h)	99	26	17	130	28	165	12	1450	68	53	1209	25
Future Volume (veh/h)	99	26	17	130	28	165	12	1450	68	53	1209	25
Initial Q (Qb), veh	0	0	0	0	0	0	0	0	0	0	0	0
Ped-Bike Adj(A_pbT)	1.00		1.00	1.00		1.00	1.00		1.00	1.00		1.00
Parking Bus, Adj	1.00	1.00	1.00	1.00	1.00	1.00	1.00	1.00	1.00	1.00	1.00	1.00
Work Zone On Approach		No			No			No			No	
Adj Sat Flow, veh/h/ln	1870	1870	1870	1870	1870	1870	1870	1870	1870	1870	1870	1870
Adj Flow Rate, veh/h	108	28	18	141	30	179	13	1576	74	58	1314	27
Peak Hour Factor	0.92	0.92	0.92	0.92	0.92	0.92	0.92	0.92	0.92	0.92	0.92	0.92
Percent Heavy Veh, %	2	2	2	2	2	2	2	2	2	2	2	2
Cap, veh/h	170	109	92	282	242	205	724	1730	537	623	1456	452
Arrive On Green	0.03	0.06	0.06	0.10	0.13	0.13	0.12	0.11	0.11	0.10	0.09	0.09
Sat Flow, veh/h	1781	1870	1585	1781	1870	1585	1781	5106	1585	1781	5106	1585
Grp Volume(v), veh/h	108	28	18	141	30	179	13	1576	74	58	1314	27
Grp Sat Flow(s),veh/h/ln	1781	1870	1585	1781	1870	1585	1781	1702	1585	1781	1702	1585
Q Serve(g_s), s	0.0	1.7	1.3	2.1	1.7	13.3	0.0	36.6	5.1	0.0	30.6	1.9
Cycle Q Clear(g_c), s	0.0	1.7	1.3	2.1	1.7	13.3	0.0	36.6	5.1	0.0	30.6	1.9
Prop In Lane	1.00		1.00	1.00		1.00	1.00		1.00	1.00		1.00
Lane Grp Cap(c), veh/h	170	109	92	282	242	205	724	1730	537	623	1456	452
V/C Ratio(X)	0.64	0.26	0.19	0.50	0.12	0.87	0.02	0.91	0.14	0.09	0.90	0.06
Avail Cap(c_a), veh/h	320	358	304	305	358	304	724	2340	726	623	2340	726
HCM Platoon Ratio	1.00	1.00	1.00	1.00	1.00	1.00	0.33	0.33	0.33	0.33	0.33	0.33
Upstream Filter(I)	1.00	1.00	1.00	1.00	1.00	1.00	1.00	1.00	1.00	0.48	0.48	0.48
Uniform Delay (d), s/veh	54.9	54.0	53.8	48.0	46.2	51.3	32.9	51.5	37.5	36.8	52.7	39.7
Incr Delay (d2), s/veh	1.5	0.5	0.4	0.5	0.1	12.1	0.0	8.8	0.5	0.0	4.9	0.1
Initial Q Delay(d3),s/veh	0.0	0.0	0.0	0.0	0.0	0.0	0.0	0.0	0.0	0.0	0.0	0.0
%ile BackOfQ(50%),veh/ln	3.3	0.8	0.5	3.9	0.8	6.0	0.3	18.0	2.1	1.5	14.6	0.8
Unsig. Movement Delay, s/veh												
LnGrp Delay(d),s/veh	56.4	54.5	54.2	48.5	46.3	63.4	32.9	60.3	38.0	36.8	57.6	39.8
LnGrp LOS	E	D	D	D	D	E	C	E	D	D	E	D
Approach Vol, veh/h		154			350			1663			1399	
Approach Delay, s/veh		55.8			55.9			59.1			56.4	
Approach LOS		E			E			E			E	
Timer - Assigned Phs	1	2	3	4	5	6	7	8				
Phs Duration (G+Y+Rc), s	48.4	40.2	7.9	23.5	41.9	46.7	16.4	15.0				
Change Period (Y+Rc), s	* 4	6.0	* 4	8.0	* 4	6.0	* 4	8.0				
Max Green Setting (Gmax), s	* 6	55.0	* 14	23.0	* 6	55.0	* 14	23.0				
Max Q Clear Time (g_c+I1), s	2.0	32.6	2.0	15.3	2.0	38.6	4.1	3.7				
Green Ext Time (p_c), s	0.0	1.7	0.1	0.2	0.0	2.0	0.1	0.1				

Intersection Summary

HCM 6th Ctrl Delay	57.6
HCM 6th LOS	E

Notes

User approved pedestrian interval to be less than phase max green.
 * HCM 6th computational engine requires equal clearance times for the phases crossing the barrier.

3: Scottsdale Road & Driveway A

08/17/2022

Intersection						
Int Delay, s/veh	0					
Movement	EBL	EBR	NBL	NBT	SBT	SBR
Lane Configurations		↗	↘	↑↑↑	↑↑↑	↗
Traffic Vol, veh/h	0	2	2	1522	1369	1
Future Vol, veh/h	0	2	2	1522	1369	1
Conflicting Peds, #/hr	0	0	0	0	0	0
Sign Control	Stop	Stop	Free	Free	Free	Free
RT Channelized	-	None	-	None	-	None
Storage Length	-	0	110	-	-	110
Veh in Median Storage, #	0	-	-	0	0	-
Grade, %	0	-	-	0	0	-
Peak Hour Factor	92	92	92	92	92	92
Heavy Vehicles, %	2	2	2	2	2	2
Mvmt Flow	0	2	2	1654	1488	1

Major/Minor	Minor2	Major1	Major2		
Conflicting Flow All	-	744	1489	0	-
Stage 1	-	-	-	-	-
Stage 2	-	-	-	-	-
Critical Hdwy	-	7.14	5.34	-	-
Critical Hdwy Stg 1	-	-	-	-	-
Critical Hdwy Stg 2	-	-	-	-	-
Follow-up Hdwy	-	3.92	3.12	-	-
Pot Cap-1 Maneuver	0	*610	*767	-	-
Stage 1	0	-	-	-	-
Stage 2	0	-	-	-	-
Platoon blocked, %		1	1	-	-
Mov Cap-1 Maneuver	-	*610	*767	-	-
Mov Cap-2 Maneuver	-	-	-	-	-
Stage 1	-	-	-	-	-
Stage 2	-	-	-	-	-

Approach	EB	NB	SB
HCM Control Delay, s	10.9	0	0
HCM LOS	B		

Minor Lane/Major Mvmt	NBL	NBT	EBLn1	SBT	SBR
Capacity (veh/h)	* 767	-	610	-	-
HCM Lane V/C Ratio	0.003	-	0.004	-	-
HCM Control Delay (s)	9.7	-	10.9	-	-
HCM Lane LOS	A	-	B	-	-
HCM 95th %tile Q(veh)	0	-	0	-	-

Notes
 ~: Volume exceeds capacity \$: Delay exceeds 300s +: Computation Not Defined *: All major volume in platoon

Intersection												
Int Delay, s/veh	1.1											
Movement	EBL	EBT	EBR	WBL	WBT	WBR	NBL	NBT	NBR	SBL	SBT	SBR
Lane Configurations	↵	↵		↵	↵	↵	↵	↵↵↵	↵	↵	↵↵↵	↵
Traffic Vol, veh/h	10	2	31	13	1	120	30	1405	44	69	1295	12
Future Vol, veh/h	10	2	31	13	1	120	30	1405	44	69	1295	12
Conflicting Peds, #/hr	0	0	0	0	0	0	0	0	0	0	0	0
Sign Control	Stop	Stop	Stop	Stop	Stop	Stop	Free	Free	Free	Free	Free	Free
RT Channelized	-	-	None	-	-	None	-	-	None	-	-	None
Storage Length	100	-	-	80	-	115	200	-	205	195	-	100
Veh in Median Storage, #	-	0	-	-	0	-	-	0	-	-	0	-
Grade, %	-	0	-	-	0	-	-	0	-	-	0	-
Peak Hour Factor	92	92	92	92	92	92	92	92	92	92	92	92
Heavy Vehicles, %	2	2	2	2	2	2	2	2	2	2	2	2
Mvmt Flow	11	2	34	14	1	130	33	1527	48	75	1408	13

Major/Minor	Minor2		Minor1		Major1			Major2				
Conflicting Flow All	2235	3199	704	2307	3164	764	1421	0	0	1575	0	0
Stage 1	1558	1558	-	1593	1593	-	-	-	-	-	-	-
Stage 2	677	1641	-	714	1571	-	-	-	-	-	-	-
Critical Hdwy	6.44	6.54	7.14	6.44	6.54	7.14	5.34	-	-	5.34	-	-
Critical Hdwy Stg 1	7.34	5.54	-	7.34	5.54	-	-	-	-	-	-	-
Critical Hdwy Stg 2	6.74	5.54	-	6.74	5.54	-	-	-	-	-	-	-
Follow-up Hdwy	3.82	4.02	3.92	3.82	4.02	3.92	3.12	-	-	3.12	-	-
Pot Cap-1 Maneuver	*311	143	*632	*311	*164	*588	770	-	-	*740	-	-
Stage 1	*458	491	-	*604	*574	-	-	-	-	-	-	-
Stage 2	*604	550	-	*648	*482	-	-	-	-	-	-	-
Platoon blocked, %	1	1	1	1	1	1	1	-	-	1	-	-
Mov Cap-1 Maneuver	*215	123	*632	*260	*141	*588	770	-	-	*740	-	-
Mov Cap-2 Maneuver	*215	123	-	*260	*141	-	-	-	-	-	-	-
Stage 1	*438	442	-	*578	*550	-	-	-	-	-	-	-
Stage 2	*449	526	-	*549	*434	-	-	-	-	-	-	-

Approach	EB	WB	NB	SB
HCM Control Delay, s	15	13.7	0.2	0.5
HCM LOS	C	B		

Minor Lane/Major Mvmt	NBL	NBT	NBR	EBLn1	EBLn2	WBLn1	WBLn2	WBLn3	SBL	SBT	SBR
Capacity (veh/h)	770	-	-	215	505	260	141	588	*740	-	-
HCM Lane V/C Ratio	0.042	-	-	0.051	0.071	0.054	0.008	0.222	0.101	-	-
HCM Control Delay (s)	9.9	-	-	22.6	12.7	19.6	30.7	12.9	10.4	-	-
HCM Lane LOS	A	-	-	C	B	C	D	B	B	-	-
HCM 95th %tile Q(veh)	0.1	-	-	0.2	0.2	0.2	0	0.8	0.3	-	-

Notes
 ~: Volume exceeds capacity \$: Delay exceeds 300s +: Computation Not Defined *: All major volume in platoon

5: Scottsdale Road & Kierland Boulevard/Greenway Hayden Loop

08/17/2022

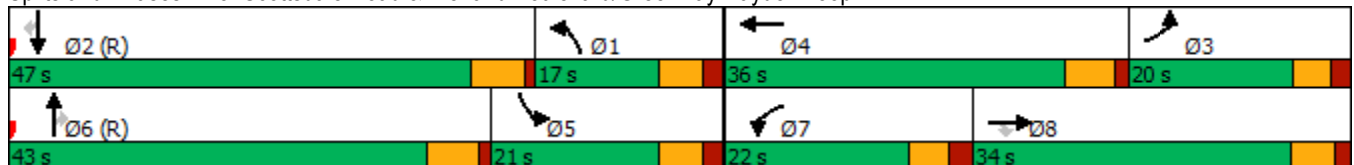


Lane Group	EBL	EBT	EBR	WBL	WBT	NBL	NBT	NBR	SBL	SBT	SBR
Lane Configurations	↔↔	↑↑	↔	↔↔	↑↑↑	↔↔	↑↑↑	↔	↔↔	↑↑↑	↔
Traffic Volume (vph)	164	183	75	363	351	113	1147	270	205	907	213
Future Volume (vph)	164	183	75	363	351	113	1147	270	205	907	213
Turn Type	Prot	NA	Perm	Prot	NA	Prot	NA	Perm	Prot	NA	Perm
Protected Phases	3	8		7	4	1	6		5	2	
Permitted Phases			8					6			2
Detector Phase	3	8	8	7	4	1	6	6	5	2	2
Switch Phase											
Minimum Initial (s)	5.0	7.0	7.0	5.0	7.0	5.0	10.0	10.0	5.0	10.0	10.0
Minimum Split (s)	11.0	13.0	13.0	11.0	13.0	11.0	39.7	39.7	11.0	37.7	37.7
Total Split (s)	20.0	34.0	34.0	22.0	36.0	17.0	43.0	43.0	21.0	47.0	47.0
Total Split (%)	16.7%	28.3%	28.3%	18.3%	30.0%	14.2%	35.8%	35.8%	17.5%	39.2%	39.2%
Yellow Time (s)	3.3	4.0	4.0	3.6	4.4	4.0	4.7	4.7	4.0	4.7	4.7
All-Red Time (s)	2.0	1.6	1.6	2.0	1.3	2.0	1.0	1.0	2.0	1.0	1.0
Lost Time Adjust (s)	0.0	0.0	0.0	0.0	0.0	0.0	0.0	0.0	0.0	0.0	0.0
Total Lost Time (s)	5.3	5.6	5.6	5.6	5.7	6.0	5.7	5.7	6.0	5.7	5.7
Lead/Lag	Lag	Lag	Lag	Lead	Lead	Lag	Lead	Lead	Lag	Lead	Lead
Lead-Lag Optimize?	Yes	Yes	Yes	Yes	Yes	Yes	Yes	Yes	Yes	Yes	Yes
Recall Mode	None	None	None	None	None	None	C-Min	C-Min	None	C-Min	C-Min
Act Effct Green (s)	13.4	11.8	11.8	17.3	15.9	16.6	56.0	56.0	12.0	51.5	51.5
Actuated g/C Ratio	0.11	0.10	0.10	0.14	0.13	0.14	0.47	0.47	0.10	0.43	0.43
v/c Ratio	0.46	0.57	0.30	0.80	0.74	0.26	0.53	0.35	0.65	0.45	0.29
Control Delay	53.8	57.7	4.5	69.6	56.9	31.1	31.9	18.7	54.6	13.6	2.3
Queue Delay	0.0	0.0	0.0	0.0	0.0	0.0	0.0	0.0	0.0	0.0	0.0
Total Delay	53.8	57.7	4.5	69.6	56.9	31.1	31.9	18.7	54.6	13.6	2.3
LOS	D	E	A	E	E	C	C	B	D	B	A
Approach Delay		46.7			62.3		29.5			18.1	
Approach LOS		D			E		C			B	

Intersection Summary

Cycle Length: 120
 Actuated Cycle Length: 120
 Offset: 95 (79%), Referenced to phase 2:SBT and 6:NBT, Start of 1st Green
 Natural Cycle: 80
 Control Type: Actuated-Coordinated
 Maximum v/c Ratio: 0.80
 Intersection Signal Delay: 34.4
 Intersection Capacity Utilization 63.3%
 Analysis Period (min) 15
 Intersection LOS: C
 ICU Level of Service B

Splits and Phases: 5: Scottsdale Road & Kierland Boulevard/Greenway Hayden Loop



5: Scottsdale Road & Kierland Boulevard/Greenway Hayden Loop

08/17/2022



Movement	EBL	EBT	EBR	WBL	WBT	WBR	NBL	NBT	NBR	SBL	SBT	SBR
Lane Configurations	↔↔	↑↑	↗	↔↔	↔↔↔		↔↔	↑↑↑	↗	↔↔	↑↑↑	↗
Traffic Volume (veh/h)	164	183	75	363	351	134	113	1147	270	205	907	213
Future Volume (veh/h)	164	183	75	363	351	134	113	1147	270	205	907	213
Initial Q (Qb), veh	0	0	0	0	0	0	0	0	0	0	0	0
Ped-Bike Adj(A_pbT)	1.00		1.00	1.00		1.00	1.00		1.00	1.00		1.00
Parking Bus, Adj	1.00	1.00	1.00	1.00	1.00	1.00	1.00	1.00	1.00	1.00	1.00	1.00
Work Zone On Approach		No			No			No			No	
Adj Sat Flow, veh/h/ln	1870	1870	1870	1870	1870	1870	1870	1870	1870	1870	1870	1870
Adj Flow Rate, veh/h	178	199	82	395	382	146	123	1247	293	223	986	232
Peak Hour Factor	0.92	0.92	0.92	0.92	0.92	0.92	0.92	0.92	0.92	0.92	0.92	0.92
Percent Heavy Veh, %	2	2	2	2	2	2	2	2	2	2	2	2
Cap, veh/h	237	279	124	453	516	188	1290	1382	429	1137	1156	359
Arrive On Green	0.07	0.08	0.08	0.04	0.05	0.05	0.75	0.54	0.54	0.66	0.45	0.45
Sat Flow, veh/h	3456	3554	1585	3456	3691	1342	3456	5106	1585	3456	5106	1585
Grp Volume(v), veh/h	178	199	82	395	351	177	123	1247	293	223	986	232
Grp Sat Flow(s),veh/h/ln	1728	1777	1585	1728	1702	1629	1728	1702	1585	1728	1702	1585
Q Serve(g_s), s	6.1	6.6	3.0	13.6	12.2	12.9	1.2	26.3	11.2	3.0	20.7	13.6
Cycle Q Clear(g_c), s	6.1	6.6	3.0	13.6	12.2	12.9	1.2	26.3	11.2	3.0	20.7	13.6
Prop In Lane	1.00		1.00	1.00		0.82	1.00		1.00	1.00		1.00
Lane Grp Cap(c), veh/h	237	279	124	453	476	228	1290	1382	429	1137	1156	359
V/C Ratio(X)	0.75	0.71	0.66	0.87	0.74	0.78	0.10	0.90	0.68	0.20	0.85	0.65
Avail Cap(c_a), veh/h	423	841	375	472	860	411	1290	1587	493	1137	1757	546
HCM Platoon Ratio	1.00	1.00	1.00	0.33	0.33	0.33	2.00	2.00	2.00	2.00	2.00	2.00
Upstream Filter(I)	1.00	1.00	1.00	0.95	0.95	0.95	0.83	0.83	0.83	1.00	1.00	1.00
Uniform Delay (d), s/veh	54.9	54.0	12.9	56.4	55.0	55.4	9.7	26.1	11.4	14.3	31.1	29.1
Incr Delay (d2), s/veh	1.8	1.3	2.2	14.5	0.8	2.1	0.0	8.4	7.1	0.0	8.0	8.7
Initial Q Delay(d3),s/veh	0.0	0.0	0.0	0.0	0.0	0.0	0.0	0.0	0.0	0.0	0.0	0.0
%ile BackOfQ(50%),veh/ln	2.7	3.0	2.4	7.2	5.6	5.8	0.4	7.7	3.7	1.1	6.8	5.0
Unsig. Movement Delay, s/veh												
LnGrp Delay(d),s/veh	56.7	55.3	15.1	70.9	55.8	57.4	9.7	34.5	18.5	14.3	39.1	37.8
LnGrp LOS	E	E	B	E	E	E	A	C	B	B	D	D
Approach Vol, veh/h		459			923			1663			1441	
Approach Delay, s/veh		48.6			62.6			29.8			35.1	
Approach LOS		D			E			C			D	
Timer - Assigned Phs	1	2	3	4	5	6	7	8				
Phs Duration (G+Y+Rc), s	50.8	32.9	13.8	22.5	45.5	38.2	21.3	15.0				
Change Period (Y+Rc), s	6.0	5.7	* 5.6	* 5.7	6.0	5.7	5.6	* 5.6				
Max Green Setting (Gmax), s	11.0	41.3	* 15	* 30	15.0	37.3	16.4	* 28				
Max Q Clear Time (g_c+I1), s	3.2	22.7	8.1	14.9	5.0	28.3	15.6	8.6				
Green Ext Time (p_c), s	0.1	4.5	0.2	1.9	0.3	4.2	0.1	0.9				

Intersection Summary

HCM 6th Ctrl Delay	40.2
HCM 6th LOS	D

Notes

User approved pedestrian interval to be less than phase max green.
 * HCM 6th computational engine requires equal clearance times for the phases crossing the barrier.

6: Scottsdale Road & Greenway Parkway/Butherus Drive

08/17/2022



Movement	EBL	EBT	EBR	WBL	WBT	WBR	NBL	NBT	NBR	SBL	SBT	SBR
Lane Configurations	↔↔	↕↔	↔	↔↔	↕↕	↔	↔↔	↕↕↕	↔	↔↔	↕↕↕	↔
Traffic Volume (veh/h)	227	197	180	295	393	211	408	1116	232	98	1062	162
Future Volume (veh/h)	227	197	180	295	393	211	408	1116	232	98	1062	162
Initial Q (Qb), veh	0	0	0	0	0	0	0	0	0	0	0	0
Ped-Bike Adj(A_pbT)	1.00		1.00	1.00		1.00	1.00		1.00	1.00		1.00
Parking Bus, Adj	1.00	1.00	1.00	1.00	1.00	1.00	1.00	1.00	1.00	1.00	1.00	1.00
Work Zone On Approach		No			No			No			No	
Adj Sat Flow, veh/h/ln	1870	1870	1870	1870	1870	1870	1870	1870	1870	1870	1870	1870
Adj Flow Rate, veh/h	247	303	137	321	427	229	443	1213	0	107	1154	176
Peak Hour Factor	0.92	0.92	0.92	0.92	0.92	0.92	0.92	0.92	0.92	0.92	0.92	0.92
Percent Heavy Veh, %	2	2	2	2	2	2	2	2	2	2	2	2
Cap, veh/h	305	392	664	459	541	241	1084	2661		157	1303	540
Arrive On Green	0.09	0.10	0.10	0.13	0.15	0.15	0.31	0.52	0.00	0.09	0.51	0.51
Sat Flow, veh/h	3563	3741	1585	3456	3554	1585	3456	5106	1585	3456	5106	1585
Grp Volume(v), veh/h	247	303	137	321	427	229	443	1213	0	107	1154	176
Grp Sat Flow(s),veh/h/ln	1781	1870	1585	1728	1777	1585	1728	1702	1585	1728	1702	1585
Q Serve(g_s), s	8.2	9.5	0.0	10.7	13.9	14.3	12.1	17.9	0.0	3.6	24.2	0.0
Cycle Q Clear(g_c), s	8.2	9.5	0.0	10.7	13.9	14.3	12.1	17.9	0.0	3.6	24.2	0.0
Prop In Lane	1.00		1.00	1.00		1.00	1.00		1.00	1.00		1.00
Lane Grp Cap(c), veh/h	305	392	664	459	541	241	1084	2661		157	1303	540
V/C Ratio(X)	0.81	0.77	0.21	0.70	0.79	0.95	0.41	0.46		0.68	0.89	0.33
Avail Cap(c_a), veh/h	356	764	821	518	903	403	1084	2661		173	1630	641
HCM Platoon Ratio	1.00	1.00	1.00	1.00	1.00	1.00	1.00	1.00	1.00	2.00	2.00	2.00
Upstream Filter(I)	1.00	1.00	1.00	1.00	1.00	1.00	1.00	1.00	0.00	0.83	0.83	0.83
Uniform Delay (d), s/veh	53.9	52.3	22.2	49.8	49.0	35.0	32.4	18.0	0.0	53.7	27.8	18.5
Incr Delay (d2), s/veh	9.9	1.2	0.1	2.7	1.0	16.7	0.1	0.6	0.0	5.9	7.7	1.3
Initial Q Delay(d3),s/veh	0.0	0.0	0.0	0.0	0.0	0.0	0.0	0.0	0.0	0.0	0.0	0.0
%ile BackOfQ(50%),veh/ln	4.0	4.4	2.4	4.7	6.2	6.5	4.9	6.7	0.0	1.6	7.4	2.5
Unsig. Movement Delay, s/veh												
LnGrp Delay(d),s/veh	63.8	53.5	22.3	52.4	50.0	51.7	32.5	18.6	0.0	59.6	35.5	19.8
LnGrp LOS	E	D	C	D	D	D	C	B		E	D	B
Approach Vol, veh/h		687			977			1656			1437	
Approach Delay, s/veh		51.0			51.2			22.3			35.4	
Approach LOS		D			D			C			D	
Timer - Assigned Phs	1	2	3	4	5	6	7	8				
Phs Duration (G+Y+Rc), s	43.7	36.3	16.3	23.8	11.4	68.5	21.9	18.1				
Change Period (Y+Rc), s	6.0	5.7	6.0	5.5	6.0	* 6	6.0	5.5				
Max Green Setting (Gmax), s	16.0	38.3	12.0	30.5	6.0	* 48	18.0	24.5				
Max Q Clear Time (g_c+I1), s	14.1	26.2	10.2	16.3	5.6	19.9	12.7	11.5				
Green Ext Time (p_c), s	0.2	4.4	0.1	1.9	0.0	5.8	0.3	1.1				

Intersection Summary

HCM 6th Ctrl Delay	36.3
HCM 6th LOS	D

Notes

- User approved pedestrian interval to be less than phase max green.
- User approved volume balancing among the lanes for turning movement.
- * HCM 6th computational engine requires equal clearance times for the phases crossing the barrier.

Intersection						
Int Delay, s/veh	4.2					
Movement	EBL	EBT	WBT	WBR	SBL	SBR
Lane Configurations						
Traffic Vol, veh/h	52	87	193	50	37	127
Future Vol, veh/h	52	87	193	50	37	127
Conflicting Peds, #/hr	0	0	0	0	0	0
Sign Control	Free	Free	Free	Free	Stop	Stop
RT Channelized	-	None	-	None	-	None
Storage Length	100	-	-	-	0	-
Veh in Median Storage, #	-	0	0	-	0	-
Grade, %	-	0	0	-	0	-
Peak Hour Factor	92	92	92	92	92	92
Heavy Vehicles, %	2	2	2	2	2	2
Mvmt Flow	57	95	210	54	40	138
Major/Minor	Major1	Major2	Minor2			
Conflicting Flow All	264	0	-	0	446	237
Stage 1	-	-	-	-	237	-
Stage 2	-	-	-	-	209	-
Critical Hdwy	4.12	-	-	-	6.42	6.22
Critical Hdwy Stg 1	-	-	-	-	5.42	-
Critical Hdwy Stg 2	-	-	-	-	5.42	-
Follow-up Hdwy	2.218	-	-	-	3.518	3.318
Pot Cap-1 Maneuver	1300	-	-	-	584	802
Stage 1	-	-	-	-	802	-
Stage 2	-	-	-	-	843	-
Platoon blocked, %		-	-	-	1	
Mov Cap-1 Maneuver	1300	-	-	-	558	802
Mov Cap-2 Maneuver	-	-	-	-	619	-
Stage 1	-	-	-	-	767	-
Stage 2	-	-	-	-	843	-
Approach	EB	WB	SB			
HCM Control Delay, s	3	0	11.3			
HCM LOS	B					
Minor Lane/Major Mvmt	EBL	EBT	WBT	WBR	SBLn1	
Capacity (veh/h)	1300	-	-	-	752	
HCM Lane V/C Ratio	0.043	-	-	-	0.237	
HCM Control Delay (s)	7.9	-	-	-	11.3	
HCM Lane LOS	A	-	-	-	B	
HCM 95th %tile Q(veh)	0.1	-	-	-	0.9	

Intersection						
Int Delay, s/veh	2.9					
Movement	EBT	EBR	WBL	WBT	NBL	NBR
Lane Configurations						
Traffic Vol, veh/h	92	68	36	175	68	42
Future Vol, veh/h	92	68	36	175	68	42
Conflicting Peds, #/hr	0	0	0	0	0	0
Sign Control	Free	Free	Free	Free	Stop	Stop
RT Channelized	-	None	-	None	-	None
Storage Length	-	-	100	-	80	0
Veh in Median Storage, #	0	-	-	0	0	-
Grade, %	0	-	-	0	0	-
Peak Hour Factor	92	92	92	92	92	92
Heavy Vehicles, %	2	2	2	2	2	2
Mvmt Flow	100	74	39	190	74	46

Major/Minor	Major1	Major2	Minor1		
Conflicting Flow All	0	0	174	0	405 137
Stage 1	-	-	-	-	137 -
Stage 2	-	-	-	-	268 -
Critical Hdwy	-	-	4.12	-	6.42 6.22
Critical Hdwy Stg 1	-	-	-	-	5.42 -
Critical Hdwy Stg 2	-	-	-	-	5.42 -
Follow-up Hdwy	-	-	2.218	-	3.518 3.318
Pot Cap-1 Maneuver	-	-	1413	-	618 951
Stage 1	-	-	-	-	911 -
Stage 2	-	-	-	-	777 -
Platoon blocked, %	-	-	1	-	1 1
Mov Cap-1 Maneuver	-	-	1413	-	601 951
Mov Cap-2 Maneuver	-	-	-	-	643 -
Stage 1	-	-	-	-	911 -
Stage 2	-	-	-	-	755 -

Approach	EB	WB	NB
HCM Control Delay, s	0	1.3	10.4
HCM LOS			B

Minor Lane/Major Mvmt	NBLn1	NBLn2	EBT	EBR	WBL	WBT
Capacity (veh/h)	643	951	-	-	1413	-
HCM Lane V/C Ratio	0.115	0.048	-	-	0.028	-
HCM Control Delay (s)	11.3	9	-	-	7.6	-
HCM Lane LOS	B	A	-	-	A	-
HCM 95th %tile Q(veh)	0.4	0.2	-	-	0.1	-

Intersection						
Int Delay, s/veh	2.1					
Movement	WBL	WBR	NBT	NBR	SBL	SBT
Lane Configurations	↔	↔	↔		↔	↔
Traffic Vol, veh/h	23	23	82	6	1	75
Future Vol, veh/h	23	23	82	6	1	75
Conflicting Peds, #/hr	0	0	0	0	0	0
Sign Control	Stop	Stop	Free	Free	Free	Free
RT Channelized	-	None	-	None	-	None
Storage Length	75	0	-	-	100	-
Veh in Median Storage, #	0	-	0	-	-	0
Grade, %	0	-	0	-	-	0
Peak Hour Factor	92	92	92	92	92	92
Heavy Vehicles, %	2	2	2	2	2	2
Mvmt Flow	25	25	89	7	1	82

Major/Minor	Minor1	Major1	Major2		
Conflicting Flow All	177	93	0	0	96
Stage 1	93	-	-	-	-
Stage 2	84	-	-	-	-
Critical Hdwy	6.42	6.22	-	-	4.12
Critical Hdwy Stg 1	5.42	-	-	-	-
Critical Hdwy Stg 2	5.42	-	-	-	-
Follow-up Hdwy	3.518	3.318	-	-	2.218
Pot Cap-1 Maneuver	813	964	-	-	1498
Stage 1	931	-	-	-	-
Stage 2	939	-	-	-	-
Platoon blocked, %			-	-	-
Mov Cap-1 Maneuver	812	964	-	-	1498
Mov Cap-2 Maneuver	797	-	-	-	-
Stage 1	931	-	-	-	-
Stage 2	938	-	-	-	-

Approach	WB	NB	SB
HCM Control Delay, s	9.3	0	0.1
HCM LOS	A		

Minor Lane/Major Mvmt	NBT	NBRWBLn1	WBLn2	SBL	SBT
Capacity (veh/h)	-	-	797	964	1498
HCM Lane V/C Ratio	-	-	0.031	0.026	0.001
HCM Control Delay (s)	-	-	9.7	8.8	7.4
HCM Lane LOS	-	-	A	A	A
HCM 95th %tile Q(veh)	-	-	0.1	0.1	0

Intersection												
Int Delay, s/veh	0.2											
Movement	EBL	EBT	EBR	WBL	WBT	WBR	NBL	NBT	NBR	SBL	SBT	SBR
Lane Configurations		↕			↕		↕	↕		↕	↕	
Traffic Vol, veh/h	0	0	0	0	0	2	0	83	2	2	93	0
Future Vol, veh/h	0	0	0	0	0	2	0	83	2	2	93	0
Conflicting Peds, #/hr	0	0	0	0	0	0	0	0	0	0	0	0
Sign Control	Stop	Stop	Stop	Stop	Stop	Stop	Free	Free	Free	Free	Free	Free
RT Channelized	-	-	None	-	-	None	-	-	None	-	-	None
Storage Length	-	-	-	-	-	-	100	-	-	100	-	-
Veh in Median Storage, #	-	0	-	-	0	-	-	0	-	-	0	-
Grade, %	-	0	-	-	0	-	-	0	-	-	0	-
Peak Hour Factor	92	92	92	92	92	92	92	92	92	92	92	92
Heavy Vehicles, %	2	2	2	2	2	2	2	2	2	2	2	2
Mvmt Flow	0	0	0	0	0	2	0	90	2	2	101	0

Major/Minor	Minor2		Minor1		Major1			Major2				
Conflicting Flow All	197	197	101	196	196	91	101	0	0	92	0	0
Stage 1	105	105	-	91	91	-	-	-	-	-	-	-
Stage 2	92	92	-	105	105	-	-	-	-	-	-	-
Critical Hdwy	7.12	6.52	6.22	7.12	6.52	6.22	4.12	-	-	4.12	-	-
Critical Hdwy Stg 1	6.12	5.52	-	6.12	5.52	-	-	-	-	-	-	-
Critical Hdwy Stg 2	6.12	5.52	-	6.12	5.52	-	-	-	-	-	-	-
Follow-up Hdwy	3.518	4.018	3.318	3.518	4.018	3.318	2.218	-	-	2.218	-	-
Pot Cap-1 Maneuver	762	699	954	763	699	967	1491	-	-	1503	-	-
Stage 1	901	808	-	916	820	-	-	-	-	-	-	-
Stage 2	915	819	-	901	808	-	-	-	-	-	-	-
Platoon blocked, %								-	-	-	-	-
Mov Cap-1 Maneuver	760	698	954	762	698	967	1491	-	-	1503	-	-
Mov Cap-2 Maneuver	760	698	-	762	698	-	-	-	-	-	-	-
Stage 1	901	807	-	916	820	-	-	-	-	-	-	-
Stage 2	913	819	-	900	807	-	-	-	-	-	-	-

Approach	EB		WB		NB		SB	
HCM Control Delay, s	0		8.7		0		0.2	
HCM LOS	A		A					

Minor Lane/Major Mvmt	NBL	NBT	NBR	EBLn1	WBLn1	SBL	SBT	SBR
Capacity (veh/h)	1491	-	-	-	-	967	1503	-
HCM Lane V/C Ratio	-	-	-	-	0.002	0.001	-	-
HCM Control Delay (s)	0	-	-	0	8.7	7.4	-	-
HCM Lane LOS	A	-	-	A	A	A	-	-
HCM 95th %tile Q(veh)	0	-	-	-	0	0	-	-

Intersection												
Int Delay, s/veh	1.2											
Movement	EBL	EBT	EBR	WBL	WBT	WBR	NBL	NBT	NBR	SBL	SBT	SBR
Lane Configurations	↖	↗		↖	↗			↕			↕	
Traffic Vol, veh/h	0	114	11	16	140	0	8	0	16	0	0	0
Future Vol, veh/h	0	114	11	16	140	0	8	0	16	0	0	0
Conflicting Peds, #/hr	0	0	0	0	0	0	0	0	0	0	0	0
Sign Control	Free	Free	Free	Free	Free	Free	Stop	Stop	Stop	Stop	Stop	Stop
RT Channelized	-	-	None	-	-	None	-	-	None	-	-	None
Storage Length	100	-	-	100	-	-	-	-	-	-	-	-
Veh in Median Storage, #	-	0	-	-	0	-	-	0	-	-	0	-
Grade, %	-	0	-	-	0	-	-	0	-	-	0	-
Peak Hour Factor	92	92	92	92	92	92	92	92	92	92	92	92
Heavy Vehicles, %	2	2	2	2	2	2	2	2	2	2	2	2
Mvmt Flow	0	124	12	17	152	0	9	0	17	0	0	0

Major/Minor	Major1			Major2			Minor1			Minor2		
Conflicting Flow All	152	0	0	136	0	0	316	316	130	325	322	152
Stage 1	-	-	-	-	-	-	130	130	-	186	186	-
Stage 2	-	-	-	-	-	-	186	186	-	139	136	-
Critical Hdwy	4.12	-	-	4.12	-	-	7.12	6.52	6.22	7.12	6.52	6.22
Critical Hdwy Stg 1	-	-	-	-	-	-	6.12	5.52	-	6.12	5.52	-
Critical Hdwy Stg 2	-	-	-	-	-	-	6.12	5.52	-	6.12	5.52	-
Follow-up Hdwy	2.218	-	-	2.218	-	-	3.518	4.018	3.318	3.518	4.018	3.318
Pot Cap-1 Maneuver	1429	-	-	1448	-	-	637	600	920	628	595	894
Stage 1	-	-	-	-	-	-	874	789	-	816	746	-
Stage 2	-	-	-	-	-	-	816	746	-	864	784	-
Platoon blocked, %	-	-	-	-	-	-	-	-	-	-	-	-
Mov Cap-1 Maneuver	1429	-	-	1448	-	-	631	593	920	610	588	894
Mov Cap-2 Maneuver	-	-	-	-	-	-	631	593	-	610	588	-
Stage 1	-	-	-	-	-	-	874	789	-	816	737	-
Stage 2	-	-	-	-	-	-	806	737	-	848	784	-

Approach	EB			WB			NB			SB		
HCM Control Delay, s	0			0.8			9.7			0		
HCM LOS							A			A		

Minor Lane/Major Mvmt	NBLn1	EBL	EBT	EBR	WBL	WBT	WBR	SBLn1
Capacity (veh/h)	798	1429	-	-	1448	-	-	-
HCM Lane V/C Ratio	0.033	-	-	-	0.012	-	-	-
HCM Control Delay (s)	9.7	0	-	-	7.5	-	-	0
HCM Lane LOS	A	A	-	-	A	-	-	A
HCM 95th %tile Q(veh)	0.1	0	-	-	0	-	-	-

Intersection	
Intersection Delay, s/veh	8.6
Intersection LOS	A

Movement	EBL	EBT	EBR	WBL	WBT	WBR	NBL	NBT	NBR	SBL	SBT	SBR
Lane Configurations	↶	↷		↶	↷		↶	↷		↶	↷	
Traffic Vol, veh/h	18	50	41	38	58	3	50	63	16	8	63	28
Future Vol, veh/h	18	50	41	38	58	3	50	63	16	8	63	28
Peak Hour Factor	0.92	0.92	0.92	0.92	0.92	0.92	0.92	0.92	0.92	0.92	0.92	0.92
Heavy Vehicles, %	2	2	2	2	2	2	2	2	2	2	2	2
Mvmt Flow	20	54	45	41	63	3	54	68	17	9	68	30
Number of Lanes	1	1	0	1	1	0	1	1	0	1	1	0

Approach	EB	WB	NB	SB
Opposing Approach	WB	EB	SB	NB
Opposing Lanes	2	2	2	2
Conflicting Approach Left	SB	NB	EB	WB
Conflicting Lanes Left	2	2	2	2
Conflicting Approach Right	NB	SB	WB	EB
Conflicting Lanes Right	2	2	2	2
HCM Control Delay	8.5	8.7	8.7	8.6
HCM LOS	A	A	A	A

Lane	NBLn1	NBLn2	EBLn1	EBLn2	WBLn1	WBLn2	SBLn1	SBLn2
Vol Left, %	100%	0%	100%	0%	100%	0%	100%	0%
Vol Thru, %	0%	80%	0%	55%	0%	95%	0%	69%
Vol Right, %	0%	20%	0%	45%	0%	5%	0%	31%
Sign Control	Stop	Stop	Stop	Stop	Stop	Stop	Stop	Stop
Traffic Vol by Lane	50	79	18	91	38	61	8	91
LT Vol	50	0	18	0	38	0	8	0
Through Vol	0	63	0	50	0	58	0	63
RT Vol	0	16	0	41	0	3	0	28
Lane Flow Rate	54	86	20	99	41	66	9	99
Geometry Grp	7	7	7	7	7	7	7	7
Degree of Util (X)	0.086	0.121	0.031	0.136	0.066	0.097	0.014	0.139
Departure Headway (Hd)	5.725	5.08	5.787	4.967	5.789	5.252	5.767	5.048
Convergence, Y/N	Yes	Yes	Yes	Yes	Yes	Yes	Yes	Yes
Cap	626	705	618	721	618	681	620	709
Service Time	3.462	2.816	3.526	2.706	3.529	2.992	3.504	2.785
HCM Lane V/C Ratio	0.086	0.122	0.032	0.137	0.066	0.097	0.015	0.14
HCM Control Delay	9	8.5	8.7	8.5	8.9	8.6	8.6	8.6
HCM Lane LOS	A	A	A	A	A	A	A	A
HCM 95th-tile Q	0.3	0.4	0.1	0.5	0.2	0.3	0	0.5

15: 73rd Street/Dial Boulevard & Greenway Hayden Loop

08/17/2022

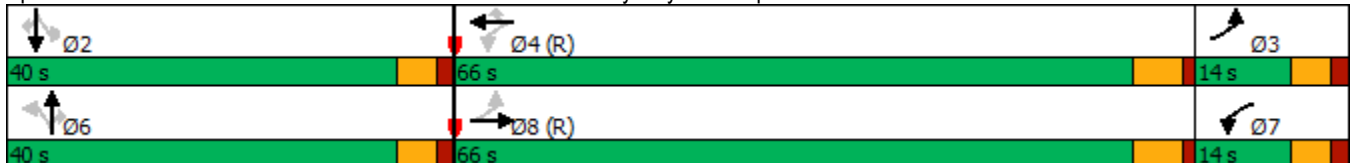


Lane Group	EBL	EBT	WBL	WBT	WBR	NBL	NBT	NBR	SBL	SBT	SBR
Lane Configurations	↘	↑↑↑	↘	↑↑	↗	↘	↑	↗	↘	↑	↗
Traffic Volume (vph)	87	486	183	697	40	94	82	339	45	71	93
Future Volume (vph)	87	486	183	697	40	94	82	339	45	71	93
Turn Type	pm+pt	NA	pm+pt	NA	Perm	Perm	NA	Perm	Perm	NA	Perm
Protected Phases	3	8	7	4			6			2	
Permitted Phases	8		4		4	6		6	2		2
Detector Phase	3	8	7	4	4	6	6	6	2	2	2
Switch Phase											
Minimum Initial (s)	5.0	10.0	5.0	10.0	10.0	7.0	7.0	7.0	7.0	7.0	7.0
Minimum Split (s)	12.0	37.0	37.0	36.0	36.0	37.0	37.0	37.0	37.0	37.0	37.0
Total Split (s)	14.0	66.0	14.0	66.0	66.0	40.0	40.0	40.0	40.0	40.0	40.0
Total Split (%)	11.7%	55.0%	11.7%	55.0%	55.0%	33.3%	33.3%	33.3%	33.3%	33.3%	33.3%
Yellow Time (s)	3.6	4.4	3.6	4.4	4.4	3.6	3.6	3.6	3.6	3.6	3.6
All-Red Time (s)	1.7	1.0	1.7	1.0	1.0	1.6	1.6	1.6	1.6	1.6	1.6
Lost Time Adjust (s)	0.0	0.0	0.0	0.0	0.0	0.0	0.0	0.0	0.0	0.0	0.0
Total Lost Time (s)	5.3	5.4	5.3	5.4	5.4	5.2	5.2	5.2	5.2	5.2	5.2
Lead/Lag	Lag	Lead	Lag	Lead	Lead						
Lead-Lag Optimize?	Yes	Yes	Yes	Yes	Yes						
Recall Mode	None	C-Min	None	C-Min	C-Min	None	None	None	None	None	None
Act Effct Green (s)	85.5	79.2	93.7	83.6	83.6	14.3	14.3	14.3	14.3	14.3	14.3
Actuated g/C Ratio	0.71	0.66	0.78	0.70	0.70	0.12	0.12	0.12	0.12	0.12	0.12
v/c Ratio	0.19	0.18	0.29	0.31	0.04	0.65	0.40	0.72	0.32	0.35	0.36
Control Delay	7.1	6.0	6.8	14.3	6.3	68.5	52.6	13.1	51.8	51.0	12.2
Queue Delay	0.0	0.0	0.0	0.0	0.0	0.0	0.0	0.0	0.0	0.0	0.0
Total Delay	7.1	6.0	6.8	14.3	6.3	68.5	52.6	13.1	51.8	51.0	12.2
LOS	A	A	A	B	A	E	D	B	D	D	B
Approach Delay		6.1		12.4			29.5			33.9	
Approach LOS		A		B			C			C	

Intersection Summary

Cycle Length: 120
 Actuated Cycle Length: 120
 Offset: 111 (93%), Referenced to phase 4:WBTL and 8:EBTL, Start of Green
 Natural Cycle: 115
 Control Type: Actuated-Coordinated
 Maximum v/c Ratio: 0.72
 Intersection Signal Delay: 16.5
 Intersection Capacity Utilization 50.6%
 Analysis Period (min) 15
 Intersection LOS: B
 ICU Level of Service A

Splits and Phases: 15: 73rd Street/Dial Boulevard & Greenway Hayden Loop



15: 73rd Street/Dial Boulevard & Greenway Hayden Loop

08/17/2022



Movement	EBL	EBT	EBR	WBL	WBT	WBR	NBL	NBT	NBR	SBL	SBT	SBR
Lane Configurations	↖	↕↕↕		↖	↕↕	↖	↖	↕	↖	↖	↕	↖
Traffic Volume (veh/h)	87	486	54	183	697	40	94	82	339	45	71	93
Future Volume (veh/h)	87	486	54	183	697	40	94	82	339	45	71	93
Initial Q (Qb), veh	0	0	0	0	0	0	0	0	0	0	0	0
Ped-Bike Adj(A_pbT)	1.00		1.00	1.00		1.00	1.00		1.00	1.00		1.00
Parking Bus, Adj	1.00	1.00	1.00	1.00	1.00	1.00	1.00	1.00	1.00	1.00	1.00	1.00
Work Zone On Approach		No			No			No			No	
Adj Sat Flow, veh/h/ln	1870	1870	1870	1870	1870	1870	1870	1870	1870	1870	1870	1870
Adj Flow Rate, veh/h	95	528	59	199	758	43	102	89	368	49	77	101
Peak Hour Factor	0.92	0.92	0.92	0.92	0.92	0.92	0.92	0.92	0.92	0.92	0.92	0.92
Percent Heavy Veh, %	2	2	2	2	2	2	2	2	2	2	2	2
Cap, veh/h	711	711	78	908	897	400	322	467	396	258	467	396
Arrive On Green	0.12	0.05	0.05	0.47	0.25	0.25	0.25	0.25	0.25	0.25	0.25	0.25
Sat Flow, veh/h	1781	4667	515	1781	3554	1585	1206	1870	1585	934	1870	1585
Grp Volume(v), veh/h	95	383	204	199	758	43	102	89	368	49	77	101
Grp Sat Flow(s),veh/h/ln	1781	1702	1778	1781	1777	1585	1206	1870	1585	934	1870	1585
Q Serve(g_s), s	1.6	13.3	13.6	2.1	24.3	2.5	8.7	4.5	27.2	5.2	3.9	6.1
Cycle Q Clear(g_c), s	1.6	13.3	13.6	2.1	24.3	2.5	12.5	4.5	27.2	9.7	3.9	6.1
Prop In Lane	1.00		0.29	1.00		1.00	1.00		1.00	1.00		1.00
Lane Grp Cap(c), veh/h	711	519	271	908	897	400	322	467	396	258	467	396
V/C Ratio(X)	0.13	0.74	0.75	0.22	0.84	0.11	0.32	0.19	0.93	0.19	0.16	0.26
Avail Cap(c_a), veh/h	711	1719	898	908	1795	800	371	542	460	296	542	460
HCM Platoon Ratio	0.33	0.33	0.33	1.00	1.00	1.00	1.00	1.00	1.00	1.00	1.00	1.00
Upstream Filter(I)	0.85	0.85	0.85	1.00	1.00	1.00	1.00	1.00	1.00	1.00	1.00	1.00
Uniform Delay (d), s/veh	33.7	54.6	54.7	17.2	42.6	34.5	40.1	35.5	44.0	39.3	35.2	36.1
Incr Delay (d2), s/veh	0.0	7.8	15.1	0.0	9.6	0.5	0.2	0.1	22.4	0.1	0.1	0.1
Initial Q Delay(d3),s/veh	0.0	0.0	0.0	0.0	0.0	0.0	0.0	0.0	0.0	0.0	0.0	0.0
%ile BackOfQ(50%),veh/ln	2.4	6.7	7.6	3.0	11.8	1.0	2.6	2.1	13.1	1.2	1.8	2.4
Unsig. Movement Delay, s/veh												
LnGrp Delay(d),s/veh	33.7	62.5	69.9	17.2	52.2	35.0	40.4	35.6	66.4	39.4	35.3	36.2
LnGrp LOS	C	E	E	B	D	D	D	D	E	D	D	D
Approach Vol, veh/h		682			1000			559			227	
Approach Delay, s/veh		60.7			44.5			56.8			36.6	
Approach LOS		E			D			E			D	
Timer - Assigned Phs		2	3	4		6	7	8				
Phs Duration (G+Y+Rc), s		35.1	49.2	35.7		35.1	61.2	23.7				
Change Period (Y+Rc), s		* 5.2	5.3	* 5.4		* 5.2	5.3	* 5.4				
Max Green Setting (Gmax), s		* 35	8.7	* 61		* 35	8.7	* 61				
Max Q Clear Time (g_c+I1), s		11.7	3.6	26.3		29.2	4.1	15.6				
Green Ext Time (p_c), s		0.6	0.0	4.0		0.7	0.1	2.7				

Intersection Summary

HCM 6th Ctrl Delay	51.0
HCM 6th LOS	D

Notes

User approved pedestrian interval to be less than phase max green.
 * HCM 6th computational engine requires equal clearance times for the phases crossing the barrier.

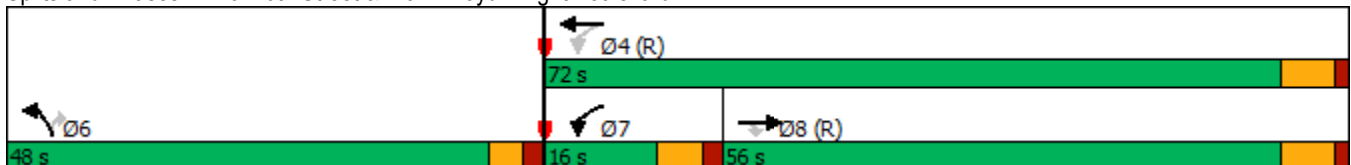


Lane Group	EBT	EBR	WBL	WBT	NBL	NBR
Lane Configurations	↑↑↑	↑	↓	↑↑↑	↓	↓
Traffic Volume (vph)	1134	92	199	1489	144	282
Future Volume (vph)	1134	92	199	1489	144	282
Turn Type	NA	Perm	pm+pt	NA	Prot	Perm
Protected Phases	8		7	4	6	
Permitted Phases		8	4			6
Detector Phase	8	8	7	4	6	6
Switch Phase						
Minimum Initial (s)	7.0	7.0	5.0	10.0	7.0	7.0
Minimum Split (s)	13.2	13.2	11.0	16.2	12.0	12.0
Total Split (s)	56.0	56.0	16.0	72.0	48.0	48.0
Total Split (%)	46.7%	46.7%	13.3%	60.0%	40.0%	40.0%
Yellow Time (s)	4.7	4.7	4.0	4.7	3.0	3.0
All-Red Time (s)	1.5	1.5	1.9	1.5	2.0	2.0
Lost Time Adjust (s)	0.0	0.0	0.0	0.0	0.0	0.0
Total Lost Time (s)	6.2	6.2	5.9	6.2	5.0	5.0
Lead/Lag	Lag	Lag	Lead			
Lead-Lag Optimize?	Yes	Yes	Yes			
Recall Mode	C-Min	C-Min	None	C-Min	None	None
Act Effct Green (s)	79.4	79.4	94.4	94.1	14.7	14.7
Actuated g/C Ratio	0.66	0.66	0.79	0.78	0.12	0.12
v/c Ratio	0.37	0.09	0.58	0.41	0.37	0.83
Control Delay	17.1	8.9	11.8	4.7	49.2	36.7
Queue Delay	0.0	0.0	0.0	0.0	0.0	0.0
Total Delay	17.1	8.9	11.8	4.7	49.2	36.7
LOS	B	A	B	A	D	D
Approach Delay	16.5			5.5	40.9	
Approach LOS	B			A	D	

Intersection Summary

Cycle Length: 120
 Actuated Cycle Length: 120
 Offset: 44 (37%), Referenced to phase 4:WBTL and 8:EBT, Start of 1st Green
 Natural Cycle: 50
 Control Type: Actuated-Coordinated
 Maximum v/c Ratio: 0.83
 Intersection Signal Delay: 14.1
 Intersection Capacity Utilization 53.0%
 Analysis Period (min) 15
 Intersection LOS: B
 ICU Level of Service A

Splits and Phases: 16: 76th Street & Frank Lloyd Wright Boulevard





Movement	EBT	EBR	WBL	WBT	NBL	NBR	
Lane Configurations	↑↑↑	↑	↓	↑↑↑	↓	↑	
Traffic Volume (veh/h)	1134	92	199	1489	144	282	
Future Volume (veh/h)	1134	92	199	1489	144	282	
Initial Q (Qb), veh	0	0	0	0	0	0	
Ped-Bike Adj(A_pbT)		1.00	1.00		1.00	1.00	
Parking Bus, Adj	1.00	1.00	1.00	1.00	1.00	1.00	
Work Zone On Approach	No			No	No		
Adj Sat Flow, veh/h/ln	1870	1870	1870	1870	1870	1870	
Adj Flow Rate, veh/h	1233	100	216	1618	157	307	
Peak Hour Factor	0.92	0.92	0.92	0.92	0.92	0.92	
Percent Heavy Veh, %	2	2	2	2	2	2	
Cap, veh/h	2950	916	417	3543	735	337	
Arrive On Green	1.00	1.00	0.13	1.00	0.21	0.21	
Sat Flow, veh/h	5274	1585	1781	5274	3456	1585	
Grp Volume(v), veh/h	1233	100	216	1618	157	307	
Grp Sat Flow(s),veh/h/ln	1702	1585	1781	1702	1728	1585	
Q Serve(g_s), s	0.0	0.0	6.0	0.0	4.5	22.7	
Cycle Q Clear(g_c), s	0.0	0.0	6.0	0.0	4.5	22.7	
Prop In Lane		1.00	1.00		1.00	1.00	
Lane Grp Cap(c), veh/h	2950	916	417	3543	735	337	
V/C Ratio(X)	0.42	0.11	0.52	0.46	0.21	0.91	
Avail Cap(c_a), veh/h	2950	916	447	3543	1238	568	
HCM Platoon Ratio	2.00	2.00	2.00	2.00	1.00	1.00	
Upstream Filter(I)	0.82	0.82	0.72	0.72	1.00	1.00	
Uniform Delay (d), s/veh	0.0	0.0	7.4	0.0	39.0	46.1	
Incr Delay (d2), s/veh	0.4	0.2	0.3	0.3	0.1	7.1	
Initial Q Delay(d3),s/veh	0.0	0.0	0.0	0.0	0.0	0.0	
%ile BackOfQ(50%),veh/ln	0.1	0.1	1.8	0.1	1.9	18.9	
Unsig. Movement Delay, s/veh							
LnGrp Delay(d),s/veh	0.4	0.2	7.6	0.3	39.0	53.2	
LnGrp LOS	A	A	A	A	D	D	
Approach Vol, veh/h	1333			1834	464		
Approach Delay, s/veh	0.3			1.2	48.4		
Approach LOS	A			A	D		
Timer - Assigned Phs				4	6	7	8
Phs Duration (G+Y+Rc), s				89.5	30.5	13.9	75.5
Change Period (Y+Rc), s				6.2	5.0	* 5.9	6.2
Max Green Setting (Gmax), s				65.8	43.0	* 10	49.8
Max Q Clear Time (g_c+I1), s				2.0	24.7	8.0	2.0
Green Ext Time (p_c), s				2.2	0.8	0.0	1.5

Intersection Summary

HCM 6th Ctrl Delay	6.9
HCM 6th LOS	A

Notes

User approved pedestrian interval to be less than phase max green.

* HCM 6th computational engine requires equal clearance times for the phases crossing the barrier.

Intersection

Intersection Delay, s/veh 9.6

Intersection LOS A

Movement	EBL	EBT	EBR	WBL	WBT	WBR	NBL	NBT	NBR	SBL	SBT	SBR
Lane Configurations												
Traffic Vol, veh/h	75	41	11	6	100	55	16	139	16	14	73	36
Future Vol, veh/h	75	41	11	6	100	55	16	139	16	14	73	36
Peak Hour Factor	0.92	0.92	0.92	0.92	0.92	0.92	0.92	0.92	0.92	0.92	0.92	0.92
Heavy Vehicles, %	2	2	2	2	2	2	2	2	2	2	2	2
Mvmt Flow	82	45	12	7	109	60	17	151	17	15	79	39
Number of Lanes	1	1	0	1	1	0	1	1	0	1	1	0

Approach	EB	WB	NB	SB
Opposing Approach	WB	EB	SB	NB
Opposing Lanes	2	2	2	2
Conflicting Approach Left	SB	NB	EB	WB
Conflicting Lanes Left	2	2	2	2
Conflicting Approach Right	NB	SB	WB	EB
Conflicting Lanes Right	2	2	2	2
HCM Control Delay	9.3	9.8	10	9.3
HCM LOS	A	A	A	A

Lane	NBLn1	NBLn2	EBLn1	EBLn2	WBLn1	WBLn2	SBLn1	SBLn2
Vol Left, %	100%	0%	100%	0%	100%	0%	100%	0%
Vol Thru, %	0%	90%	0%	79%	0%	65%	0%	67%
Vol Right, %	0%	10%	0%	21%	0%	35%	0%	33%
Sign Control	Stop	Stop	Stop	Stop	Stop	Stop	Stop	Stop
Traffic Vol by Lane	16	155	75	52	6	155	14	109
LT Vol	16	0	75	0	6	0	14	0
Through Vol	0	139	0	41	0	100	0	73
RT Vol	0	16	0	11	0	55	0	36
Lane Flow Rate	17	168	82	57	7	168	15	118
Geometry Grp	7	7	7	7	7	7	7	7
Degree of Util (X)	0.029	0.255	0.138	0.085	0.011	0.248	0.026	0.176
Departure Headway (Hd)	6.017	5.44	6.072	5.419	6.044	5.29	6.083	5.346
Convergence, Y/N	Yes	Yes	Yes	Yes	Yes	Yes	Yes	Yes
Cap	591	655	586	655	588	674	584	665
Service Time	3.793	3.216	3.856	3.202	3.823	3.068	3.866	3.128
HCM Lane V/C Ratio	0.029	0.256	0.14	0.087	0.012	0.249	0.026	0.177
HCM Control Delay	9	10.1	9.8	8.7	8.9	9.8	9	9.3
HCM Lane LOS	A	B	A	A	A	A	A	A
HCM 95th-tile Q	0.1	1	0.5	0.3	0	1	0.1	0.6

18: Greenway Hayden Loop & Frank Lloyd Wright Boulevard

08/17/2022

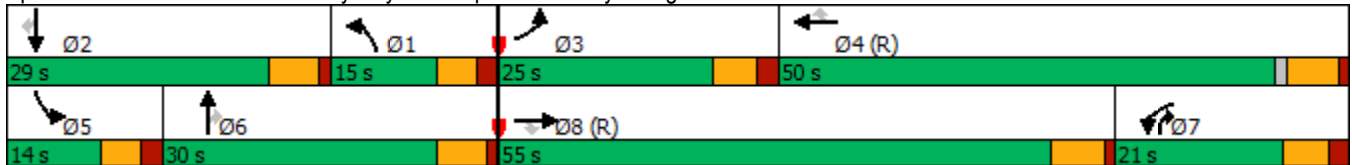


Lane Group	EBL	EBT	EBR	WBL	WBT	WBR	NBL	NBT	NBR	SBL	SBT	SBR
Lane Configurations	↔↔	↑↑↑	↔	↔↔	↑↑↑	↔	↔	↑↑	↔	↔↔	↑↑	↔
Traffic Volume (vph)	377	1215	42	415	1274	342	50	529	606	148	428	355
Future Volume (vph)	377	1215	42	415	1274	342	50	529	606	148	428	355
Turn Type	Prot	NA	Perm	Prot	NA	Perm	Prot	NA	pm+ov	Prot	NA	Perm
Protected Phases	3	8		7	4		1	6	7	5	2	
Permitted Phases			8			4			6			2
Detector Phase	3	8	8	7	4	4	1	6	7	5	2	2
Switch Phase												
Minimum Initial (s)	5.0	10.0	10.0	5.0	10.0	10.0	5.0	7.0	5.0	5.0	7.0	7.0
Minimum Split (s)	11.0	15.9	15.9	11.0	15.9	15.9	11.0	13.0	11.0	11.0	13.0	13.0
Total Split (s)	25.0	55.0	55.0	21.0	50.0	50.0	15.0	30.0	21.0	14.0	29.0	29.0
Total Split (%)	20.8%	45.8%	45.8%	17.5%	41.7%	41.7%	12.5%	25.0%	17.5%	11.7%	24.2%	24.2%
Yellow Time (s)	4.0	4.7	4.7	4.0	4.7	4.7	3.6	4.4	4.0	3.6	4.4	4.4
All-Red Time (s)	2.0	1.0	1.0	2.0	1.0	1.0	2.0	1.2	2.0	2.0	1.2	1.2
Lost Time Adjust (s)	0.0	0.0	0.0	0.0	0.0	0.0	0.0	0.0	0.0	0.0	0.0	0.0
Total Lost Time (s)	6.0	5.7	5.7	6.0	5.7	5.7	5.6	5.6	6.0	5.6	5.6	5.6
Lead/Lag	Lead	Lead	Lead	Lag	Lag	Lag	Lag	Lag	Lag	Lead	Lead	Lead
Lead-Lag Optimize?	Yes	Yes	Yes	Yes	Yes	Yes	Yes	Yes	Yes	Yes	Yes	Yes
Recall Mode	None	C-Min	C-Min	None	C-Min	C-Min	None	None	None	None	None	None
Act Effct Green (s)	16.9	38.8	38.8	28.2	50.0	50.0	9.9	22.0	49.8	8.1	22.4	22.4
Actuated g/C Ratio	0.14	0.32	0.32	0.24	0.42	0.42	0.08	0.18	0.42	0.07	0.19	0.19
v/c Ratio	0.85	0.80	0.07	0.56	0.65	0.47	0.37	0.88	0.90	0.69	0.70	0.65
Control Delay	65.1	27.0	0.5	44.9	30.7	12.8	64.1	68.9	39.1	70.7	52.7	10.7
Queue Delay	0.0	0.0	0.0	0.0	0.0	0.0	0.0	0.0	0.0	0.0	0.0	0.0
Total Delay	65.1	27.0	0.5	44.9	30.7	12.8	64.1	68.9	39.1	70.7	52.7	10.7
LOS	E	C	A	D	C	B	E	E	D	E	D	B
Approach Delay		35.1			30.6			53.5			39.5	
Approach LOS		D			C			D			D	

Intersection Summary

Cycle Length: 120
 Actuated Cycle Length: 120
 Offset: 38 (32%), Referenced to phase 4:WBT and 8:EBT, Start of 1st Green
 Natural Cycle: 90
 Control Type: Actuated-Coordinated
 Maximum v/c Ratio: 0.90
 Intersection Signal Delay: 38.0
 Intersection LOS: D
 Intersection Capacity Utilization 79.6%
 ICU Level of Service D
 Analysis Period (min) 15

Splits and Phases: 18: Greenway Hayden Loop & Frank Lloyd Wright Boulevard



18: Greenway Hayden Loop & Frank Lloyd Wright Boulevard

08/17/2022



Movement	EBL	EBT	EBR	WBL	WBT	WBR	NBL	NBT	NBR	SBL	SBT	SBR
Lane Configurations	↔↔	↑↑↑	↔	↔↔	↑↑↑	↔	↔	↑↑	↔	↔↔	↑↑	↔
Traffic Volume (veh/h)	377	1215	42	415	1274	342	50	529	606	148	428	355
Future Volume (veh/h)	377	1215	42	415	1274	342	50	529	606	148	428	355
Initial Q (Qb), veh	0	0	0	0	0	0	0	0	0	0	0	0
Ped-Bike Adj(A_pbT)	1.00		1.00	1.00		1.00	1.00		1.00	1.00		1.00
Parking Bus, Adj	1.00	1.00	1.00	1.00	1.00	1.00	1.00	1.00	1.00	1.00	1.00	1.00
Work Zone On Approach		No			No			No			No	
Adj Sat Flow, veh/h/ln	1870	1870	1870	1870	1870	1870	1870	1870	1870	1870	1870	1870
Adj Flow Rate, veh/h	410	1321	46	451	1385	372	54	575	659	161	465	386
Peak Hour Factor	0.92	0.92	0.92	0.92	0.92	0.92	0.92	0.92	0.92	0.92	0.92	0.92
Percent Heavy Veh, %	2	2	2	2	2	2	2	2	2	2	2	2
Cap, veh/h	469	1525	473	920	2180	677	165	646	710	216	538	240
Arrive On Green	0.04	0.10	0.10	0.27	0.43	0.43	0.09	0.18	0.18	0.06	0.15	0.15
Sat Flow, veh/h	3456	5106	1585	3456	5106	1585	1781	3554	1585	3456	3554	1585
Grp Volume(v), veh/h	410	1321	46	451	1385	372	54	575	659	161	465	386
Grp Sat Flow(s),veh/h/ln	1728	1702	1585	1728	1702	1585	1781	1777	1585	1728	1777	1585
Q Serve(g_s), s	14.2	30.6	3.2	13.2	25.6	21.1	3.4	19.0	9.3	5.5	15.3	13.2
Cycle Q Clear(g_c), s	14.2	30.6	3.2	13.2	25.6	21.1	3.4	19.0	9.3	5.5	15.3	13.2
Prop In Lane	1.00		1.00	1.00		1.00	1.00		1.00	1.00		1.00
Lane Grp Cap(c), veh/h	469	1525	473	920	2180	677	165	646	710	216	538	240
V/C Ratio(X)	0.88	0.87	0.10	0.49	0.64	0.55	0.33	0.89	0.93	0.75	0.86	1.61
Avail Cap(c_a), veh/h	547	2098	651	920	2180	677	165	723	744	242	693	309
HCM Platoon Ratio	0.33	0.33	0.33	1.00	1.00	1.00	1.00	1.00	1.00	1.00	1.00	1.00
Upstream Filter(I)	0.89	0.89	0.89	1.00	1.00	1.00	1.00	1.00	1.00	1.00	1.00	1.00
Uniform Delay (d), s/veh	56.3	51.7	39.4	37.1	27.0	25.8	50.9	47.9	13.5	55.3	49.7	26.9
Incr Delay (d2), s/veh	10.8	6.2	0.4	0.2	1.4	3.2	0.4	11.4	16.9	8.8	7.5	292.1
Initial Q Delay(d3),s/veh	0.0	0.0	0.0	0.0	0.0	0.0	0.0	0.0	0.0	0.0	0.0	0.0
%ile BackOfQ(50%),veh/ln	7.3	14.8	1.3	5.4	10.1	8.2	1.5	9.2	12.3	2.6	7.2	24.3
Unsig. Movement Delay, s/veh												
LnGrp Delay(d),s/veh	67.1	57.9	39.7	37.3	28.5	29.0	51.4	59.3	30.4	64.1	57.2	318.9
LnGrp LOS	E	E	D	D	C	C	D	E	C	E	E	F
Approach Vol, veh/h		1777			2208			1288			1012	
Approach Delay, s/veh		59.6			30.4			44.2			158.1	
Approach LOS		E			C			D			F	
Timer - Assigned Phs	1	2	3	4	5	6	7	8				
Phs Duration (G+Y+Rc), s	16.7	23.8	22.3	57.2	13.1	27.4	38.0	41.5				
Change Period (Y+Rc), s	* 5.6	5.6	6.0	* 6	5.6	* 5.6	6.0	5.7				
Max Green Setting (Gmax), s	* 9.4	23.4	19.0	* 44	8.4	* 24	15.0	49.3				
Max Q Clear Time (g_c+I1), s	5.4	17.3	16.2	27.6	7.5	21.0	15.2	32.6				
Green Ext Time (p_c), s	0.0	0.8	0.1	3.6	0.0	0.9	0.0	3.2				

Intersection Summary

HCM 6th Ctrl Delay	62.0
HCM 6th LOS	E

Notes

- User approved pedestrian interval to be less than phase max green.
- * HCM 6th computational engine requires equal clearance times for the phases crossing the barrier.

Intersection												
Int Delay, s/veh	1.7											
Movement	EBL	EBT	EBR	WBL	WBT	WBR	NBL	NBT	NBR	SBL	SBT	SBR
Lane Configurations		↕	↗		↕	↗	↖	↕	↗	↖	↕	↗
Traffic Vol, veh/h	10	1	21	21	1	63	25	1096	28	29	836	43
Future Vol, veh/h	10	1	21	21	1	63	25	1096	28	29	836	43
Conflicting Peds, #/hr	0	0	0	0	0	0	0	0	0	0	0	0
Sign Control	Stop	Stop	Stop	Stop	Stop	Stop	Free	Free	Free	Free	Free	Free
RT Channelized	-	-	None	-	-	None	-	-	None	-	-	None
Storage Length	-	-	130	-	-	130	150	-	-	110	-	175
Veh in Median Storage, #	-	0	-	-	0	-	-	0	-	-	0	-
Grade, %	-	0	-	-	0	-	-	0	-	-	0	-
Peak Hour Factor	92	92	92	92	92	92	92	92	92	92	92	92
Heavy Vehicles, %	2	2	2	2	2	2	2	2	2	2	2	2
Mvmt Flow	11	1	23	23	1	68	27	1191	30	32	909	47

Major/Minor	Minor2		Minor1		Major1			Major2				
Conflicting Flow All	1623	2248	455	1764	2265	596	956	0	0	1221	0	0
Stage 1	973	973	-	1245	1245	-	-	-	-	-	-	-
Stage 2	650	1275	-	519	1020	-	-	-	-	-	-	-
Critical Hdwy	7.54	6.54	6.94	7.54	6.54	6.94	4.14	-	-	4.14	-	-
Critical Hdwy Stg 1	6.54	5.54	-	6.54	5.54	-	-	-	-	-	-	-
Critical Hdwy Stg 2	6.54	5.54	-	6.54	5.54	-	-	-	-	-	-	-
Follow-up Hdwy	3.52	4.02	3.32	3.52	4.02	3.32	2.22	-	-	2.22	-	-
Pot Cap-1 Maneuver	140	47	*737	*99	46	447	*1102	-	-	567	-	-
Stage 1	677	597	-	*184	244	-	-	-	-	-	-	-
Stage 2	424	236	-	*695	558	-	-	-	-	-	-	-
Platoon blocked, %	1	1	1	1	1	1	1	-	-	-	-	-
Mov Cap-1 Maneuver	109	43	*737	*88	42	447	*1102	-	-	567	-	-
Mov Cap-2 Maneuver	109	43	-	*88	42	-	-	-	-	-	-	-
Stage 1	660	564	-	*179	238	-	-	-	-	-	-	-
Stage 2	349	230	-	*634	527	-	-	-	-	-	-	-

Approach	EB	WB	NB	SB
HCM Control Delay, s	23	27.3	0.2	0.4
HCM LOS	C	D		

Minor Lane/Major Mvmt	NBL	NBT	NBR	EBLn1	EBLn2	WBLn1	WBLn2	SBL	SBT	SBR
Capacity (veh/h)	* 1102	-	-	96	737	84	447	567	-	-
HCM Lane V/C Ratio	0.025	-	-	0.125	0.031	0.285	0.153	0.056	-	-
HCM Control Delay (s)	8.3	-	-	47.8	10	64.1	14.5	11.7	-	-
HCM Lane LOS	A	-	-	E	B	F	B	B	-	-
HCM 95th %tile Q(veh)	0.1	-	-	0.4	0.1	1	0.5	0.2	-	-

Notes
 ~: Volume exceeds capacity \$: Delay exceeds 300s +: Computation Not Defined *: All major volume in platoon



Appendix J – Year 2025 Build Capacity Analysis

1: Scottsdale Road & Bell Road/Frank Lloyd Wright Boulevard

08/17/2022



Movement	EBL	EBT	EBR	WBL	WBT	WBR	NBL	NBT	NBR	SBL	SBT	SBR
Lane Configurations	↔↔	↑↑↑	↔	↔↔	↑↑↑	↔	↔↔	↑↑↑	↔	↔↔	↑↑↑	↔
Traffic Volume (veh/h)	373	1076	369	172	429	197	177	695	102	353	1453	164
Future Volume (veh/h)	373	1076	369	172	429	197	177	695	102	353	1453	164
Initial Q (Qb), veh	0	0	0	0	0	0	0	0	0	0	0	0
Ped-Bike Adj(A_pbT)	1.00		1.00	1.00		1.00	1.00		1.00	1.00		1.00
Parking Bus, Adj	1.00	1.00	1.00	1.00	1.00	1.00	1.00	1.00	1.00	1.00	1.00	1.00
Work Zone On Approach		No			No			No			No	
Adj Sat Flow, veh/h/ln	1870	1870	1870	1870	1870	1870	1870	1870	1870	1870	1870	1870
Adj Flow Rate, veh/h	405	1170	401	187	466	214	192	755	111	384	1579	178
Peak Hour Factor	0.92	0.92	0.92	0.92	0.92	0.92	0.92	0.92	0.92	0.92	0.92	0.92
Percent Heavy Veh, %	2	2	2	2	2	2	2	2	2	2	2	2
Cap, veh/h	809	1439	447	241	609	623	249	901	280	946	1751	197
Arrive On Green	0.23	0.28	0.28	0.14	0.24	0.24	0.02	0.06	0.06	0.27	0.38	0.38
Sat Flow, veh/h	3456	5106	1585	3456	5106	1585	3456	5106	1585	3456	4656	524
Grp Volume(v), veh/h	405	1170	401	187	466	214	192	755	111	384	1154	603
Grp Sat Flow(s),veh/h/ln	1728	1702	1585	1728	1702	1585	1728	1702	1585	1728	1702	1776
Q Serve(g_s), s	12.2	25.6	29.2	6.3	10.2	0.0	6.6	17.6	6.4	10.9	38.4	38.5
Cycle Q Clear(g_c), s	12.2	25.6	29.2	6.3	10.2	0.0	6.6	17.6	6.4	10.9	38.4	38.5
Prop In Lane	1.00		1.00	1.00		1.00	1.00		1.00	1.00		0.30
Lane Grp Cap(c), veh/h	809	1439	447	241	609	623	249	901	280	946	1280	668
V/C Ratio(X)	0.50	0.81	0.90	0.78	0.76	0.34	0.77	0.84	0.40	0.41	0.90	0.90
Avail Cap(c_a), veh/h	809	1796	557	374	1370	859	288	1370	425	946	1280	668
HCM Platoon Ratio	1.00	1.00	1.00	2.00	2.00	2.00	0.33	0.33	0.33	1.00	1.00	1.00
Upstream Filter(I)	1.00	1.00	1.00	0.99	0.99	0.99	0.81	0.81	0.81	1.00	1.00	1.00
Uniform Delay (d), s/veh	39.9	40.1	41.4	50.7	44.1	21.6	57.6	54.8	31.9	35.6	35.3	35.4
Incr Delay (d2), s/veh	0.2	1.9	13.3	2.0	0.8	0.1	7.1	7.6	3.4	0.1	10.4	17.8
Initial Q Delay(d3),s/veh	0.0	0.0	0.0	0.0	0.0	0.0	0.0	0.0	0.0	0.0	0.0	0.0
%ile BackOfQ(50%),veh/ln	5.1	10.6	12.6	2.6	3.8	3.5	3.2	8.6	3.5	4.5	16.9	19.0
Unsig. Movement Delay, s/veh												
LnGrp Delay(d),s/veh	40.1	42.0	54.7	52.7	44.9	21.8	64.7	62.4	35.3	35.7	45.7	53.2
LnGrp LOS	D	D	D	D	D	C	E	E	D	D	D	D
Approach Vol, veh/h		1976			867			1058			2141	
Approach Delay, s/veh		44.2			40.9			60.0			46.0	
Approach LOS		D			D			E			D	
Timer - Assigned Phs	1	2	3	4	5	6	7	8				
Phs Duration (G+Y+Rc), s	14.7	51.1	34.1	20.1	38.8	27.0	14.4	39.8				
Change Period (Y+Rc), s	6.0	* 6	* 6	5.8	* 6	5.8	6.0	* 6				
Max Green Setting (Gmax), s	10.0	* 31	* 23	32.2	* 9	32.2	13.0	* 42				
Max Q Clear Time (g_c+I1), s	8.6	40.5	14.2	12.2	12.9	19.6	8.3	31.2				
Green Ext Time (p_c), s	0.0	0.0	0.5	2.1	0.0	1.6	0.1	2.6				

Intersection Summary

HCM 6th Ctrl Delay	47.1
HCM 6th LOS	D

Notes

User approved pedestrian interval to be less than phase max green.
 * HCM 6th computational engine requires equal clearance times for the phases crossing the barrier.

2: Scottsdale Road & Paradise Lane

08/17/2022

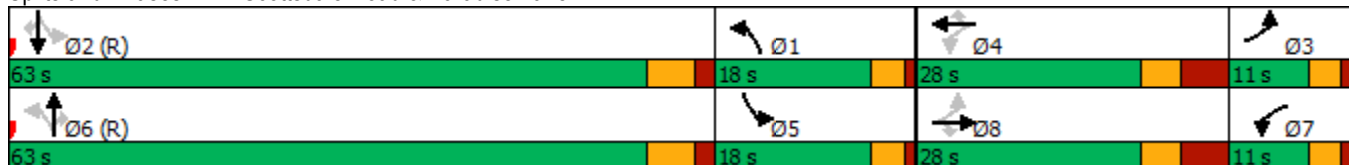


Lane Group	EBL	EBT	EBR	WBL	WBT	WBR	NBL	NBT	NBR	SBL	SBT	SBR
Lane Configurations	↘	↑	↗	↘	↑	↗	↘	↑↑↑	↗	↘	↑↑↑	↗
Traffic Volume (vph)	41	13	6	87	21	141	28	789	75	226	1478	48
Future Volume (vph)	41	13	6	87	21	141	28	789	75	226	1478	48
Turn Type	pm+pt	NA	Perm	pm+pt	NA	Perm	pm+pt	NA	Perm	pm+pt	NA	Perm
Protected Phases	3	8		7	4		1	6		5	2	
Permitted Phases	8		8	4		4	6		6	2		2
Detector Phase	3	8	8	7	4	4	1	6	6	5	2	2
Switch Phase												
Minimum Initial (s)	4.0	7.0	7.0	4.0	7.0	7.0	4.0	10.0	10.0	4.0	10.0	10.0
Minimum Split (s)	10.0	15.0	15.0	11.0	15.0	15.0	11.0	16.0	16.0	11.0	16.0	16.0
Total Split (s)	11.0	28.0	28.0	11.0	28.0	28.0	18.0	63.0	63.0	18.0	63.0	63.0
Total Split (%)	9.2%	23.3%	23.3%	9.2%	23.3%	23.3%	15.0%	52.5%	52.5%	15.0%	52.5%	52.5%
Yellow Time (s)	3.0	3.7	3.7	3.0	3.7	3.7	3.0	4.3	4.3	3.0	4.3	4.3
All-Red Time (s)	1.0	4.3	4.3	1.0	4.3	4.3	1.0	1.7	1.7	1.0	1.7	1.7
Lost Time Adjust (s)	0.0	0.0	0.0	0.0	0.0	0.0	0.0	0.0	0.0	0.0	0.0	0.0
Total Lost Time (s)	4.0	8.0	8.0	4.0	8.0	8.0	4.0	6.0	6.0	4.0	6.0	6.0
Lead/Lag	Lag	Lead	Lead	Lag	Lead	Lead	Lag	Lead	Lead	Lag	Lead	Lead
Lead-Lag Optimize?	Yes	Yes	Yes	Yes	Yes	Yes	Yes	Yes	Yes	Yes	Yes	Yes
Recall Mode	None	None	None	Min	None	None	Max	C-Min	C-Min	None	C-Min	C-Min
Act Effct Green (s)	9.9	7.0	7.0	19.1	8.0	8.0	72.3	36.2	36.2	92.1	52.1	52.1
Actuated g/C Ratio	0.08	0.06	0.06	0.16	0.07	0.07	0.60	0.30	0.30	0.77	0.43	0.43
v/c Ratio	0.30	0.13	0.04	0.36	0.19	0.62	0.05	0.56	0.15	0.28	0.73	0.07
Control Delay	50.6	56.5	0.3	47.5	55.6	19.4	15.1	34.6	10.0	26.4	21.6	1.4
Queue Delay	0.0	0.0	0.0	0.0	0.0	0.0	0.0	0.0	0.0	0.0	0.0	0.0
Total Delay	50.6	56.5	0.3	47.5	55.6	19.4	15.1	34.6	10.0	26.4	21.6	1.4
LOS	D	E	A	D	E	B	B	C	A	C	C	A
Approach Delay		46.5			32.3			31.9			21.7	
Approach LOS		D			C			C			C	

Intersection Summary

Cycle Length: 120
 Actuated Cycle Length: 120
 Offset: 20 (17%), Referenced to phase 2:SBTL and 6:NBTL, Start of 1st Green
 Natural Cycle: 60
 Control Type: Actuated-Coordinated
 Maximum v/c Ratio: 0.73
 Intersection Signal Delay: 26.2
 Intersection LOS: C
 Intersection Capacity Utilization 58.4%
 ICU Level of Service B
 Analysis Period (min) 15

Splits and Phases: 2: Scottsdale Road & Paradise Lane



2: Scottsdale Road & Paradise Lane

08/17/2022



Movement	EBL	EBT	EBR	WBL	WBT	WBR	NBL	NBT	NBR	SBL	SBT	SBR
Lane Configurations	↖	↑	↗	↖	↑	↗	↖	↑↑↑	↗	↖	↑↑↑	↗
Traffic Volume (veh/h)	41	13	6	87	21	141	28	789	75	226	1478	48
Future Volume (veh/h)	41	13	6	87	21	141	28	789	75	226	1478	48
Initial Q (Qb), veh	0	0	0	0	0	0	0	0	0	0	0	0
Ped-Bike Adj(A_pbT)	1.00		1.00	1.00		1.00	1.00		1.00	1.00		1.00
Parking Bus, Adj	1.00	1.00	1.00	1.00	1.00	1.00	1.00	1.00	1.00	1.00	1.00	1.00
Work Zone On Approach		No			No			No			No	
Adj Sat Flow, veh/h/ln	1870	1870	1870	1870	1870	1870	1870	1870	1870	1870	1870	1870
Adj Flow Rate, veh/h	45	14	7	95	23	153	30	858	82	246	1607	52
Peak Hour Factor	0.92	0.92	0.92	0.92	0.92	0.92	0.92	0.92	0.92	0.92	0.92	0.92
Percent Heavy Veh, %	2	2	2	2	2	2	2	2	2	2	2	2
Cap, veh/h	163	109	92	268	211	179	652	942	293	944	1763	547
Arrive On Green	0.03	0.06	0.06	0.08	0.11	0.11	0.67	0.37	0.37	0.16	0.11	0.11
Sat Flow, veh/h	1781	1870	1585	1781	1870	1585	1781	5106	1585	1781	5106	1585
Grp Volume(v), veh/h	45	14	7	95	23	153	30	858	82	246	1607	52
Grp Sat Flow(s),veh/h/ln	1781	1870	1585	1781	1870	1585	1781	1702	1585	1781	1702	1585
Q Serve(g_s), s	0.0	0.9	0.5	0.0	1.3	11.4	0.0	19.2	4.4	10.0	37.3	3.5
Cycle Q Clear(g_c), s	0.0	0.9	0.5	0.0	1.3	11.4	0.0	19.2	4.4	10.0	37.3	3.5
Prop In Lane	1.00		1.00	1.00		1.00	1.00		1.00	1.00		1.00
Lane Grp Cap(c), veh/h	163	109	92	268	211	179	652	942	293	944	1763	547
V/C Ratio(X)	0.28	0.13	0.08	0.35	0.11	0.86	0.05	0.91	0.28	0.26	0.91	0.09
Avail Cap(c_a), veh/h	221	312	264	268	312	264	652	2425	753	944	2425	753
HCM Platoon Ratio	1.00	1.00	1.00	1.00	1.00	1.00	2.00	2.00	2.00	0.33	0.33	0.33
Upstream Filter(I)	1.00	1.00	1.00	1.00	1.00	1.00	1.00	1.00	1.00	0.30	0.30	0.30
Uniform Delay (d), s/veh	53.5	53.6	53.4	48.8	47.8	52.3	13.4	36.9	32.2	28.3	51.3	36.4
Incr Delay (d2), s/veh	0.3	0.2	0.1	0.3	0.1	11.5	0.1	14.3	2.4	0.0	2.9	0.1
Initial Q Delay(d3),s/veh	0.0	0.0	0.0	0.0	0.0	0.0	0.0	0.0	0.0	0.0	0.0	0.0
%ile BackOfQ(50%),veh/ln	1.3	0.4	0.2	2.6	0.6	5.1	0.3	7.3	1.8	6.4	17.4	1.4
Unsig. Movement Delay, s/veh												
LnGrp Delay(d),s/veh	53.9	53.8	53.6	49.1	47.9	63.7	13.5	51.2	34.6	28.3	54.3	36.5
LnGrp LOS	D	D	D	D	D	E	B	D	C	C	D	D
Approach Vol, veh/h		66			271			970			1905	
Approach Delay, s/veh		53.8			57.3			48.7			50.4	
Approach LOS		D			E			D			D	
Timer - Assigned Phs	1	2	3	4	5	6	7	8				
Phs Duration (G+Y+Rc), s	43.9	47.4	7.1	21.5	63.2	28.1	13.6	15.0				
Change Period (Y+Rc), s	* 4	6.0	* 4	8.0	* 4	6.0	* 4	8.0				
Max Green Setting (Gmax), s	* 14	57.0	* 7	20.0	* 14	57.0	* 7	20.0				
Max Q Clear Time (g_c+I1), s	2.0	39.3	2.0	13.4	12.0	21.2	2.0	2.9				
Green Ext Time (p_c), s	0.0	2.1	0.0	0.2	0.1	1.0	0.0	0.0				

Intersection Summary

HCM 6th Ctrl Delay	50.6
HCM 6th LOS	D

Notes

- User approved pedestrian interval to be less than phase max green.
- * HCM 6th computational engine requires equal clearance times for the phases crossing the barrier.

3: Scottsdale Road & Driveway A

08/17/2022

Intersection												
Int Delay, s/veh	0.4											
Movement	EBL	EBT	EBR	WBL	WBT	WBR	NBL	NBT	NBR	SBL	SBT	SBR
Lane Configurations			↗			↗	↘	↑↑↑	↗	↘	↑↑↑	↗
Traffic Vol, veh/h	0	0	2	0	0	32	6	859	60	52	1520	3
Future Vol, veh/h	0	0	2	0	0	32	6	859	60	52	1520	3
Conflicting Peds, #/hr	0	0	0	0	0	0	0	0	0	0	0	0
Sign Control	Stop	Stop	Stop	Stop	Stop	Stop	Free	Free	Free	Free	Free	Free
RT Channelized	-	-	None	-	-	None	-	-	None	-	-	None
Storage Length	-	-	0	-	-	0	110	-	150	150	-	110
Veh in Median Storage, #	-	0	-	-	0	-	-	0	-	-	0	-
Grade, %	-	0	-	-	0	-	-	0	-	-	0	-
Peak Hour Factor	92	92	92	92	92	92	92	92	92	92	92	92
Heavy Vehicles, %	2	2	2	2	2	2	2	2	2	2	2	2
Mvmt Flow	0	0	2	0	0	35	7	934	65	57	1652	3

Major/Minor	Minor2		Minor1		Major1			Major2				
Conflicting Flow All	-	-	826	-	-	467	1655	0	0	999	0	0
Stage 1	-	-	-	-	-	-	-	-	-	-	-	-
Stage 2	-	-	-	-	-	-	-	-	-	-	-	-
Critical Hdwy	-	-	7.14	-	-	7.14	5.34	-	-	5.34	-	-
Critical Hdwy Stg 1	-	-	-	-	-	-	-	-	-	-	-	-
Critical Hdwy Stg 2	-	-	-	-	-	-	-	-	-	-	-	-
Follow-up Hdwy	-	-	3.92	-	-	3.92	3.12	-	-	3.12	-	-
Pot Cap-1 Maneuver	0	0	*567	0	0	*718	*713	-	-	876	-	-
Stage 1	0	0	-	0	0	-	-	-	-	-	-	-
Stage 2	0	0	-	0	0	-	-	-	-	-	-	-
Platoon blocked, %			1			1	1	-	-	1	-	-
Mov Cap-1 Maneuver	-	-	*567	-	-	*718	*713	-	-	876	-	-
Mov Cap-2 Maneuver	-	-	-	-	-	-	-	-	-	-	-	-
Stage 1	-	-	-	-	-	-	-	-	-	-	-	-
Stage 2	-	-	-	-	-	-	-	-	-	-	-	-

Approach	EB		WB		NB			SB		
HCM Control Delay, s	11.4		10.3		0.1			0.3		
HCM LOS	B		B							

Minor Lane/Major Mvmt	NBL	NBT	NBR	EBLn1	WBLn1	SBL	SBT	SBR
Capacity (veh/h)	* 713	-	-	567	718	876	-	-
HCM Lane V/C Ratio	0.009	-	-	0.004	0.048	0.065	-	-
HCM Control Delay (s)	10.1	-	-	11.4	10.3	9.4	-	-
HCM Lane LOS	B	-	-	B	B	A	-	-
HCM 95th %tile Q(veh)	0	-	-	0	0.2	0.2	-	-

Notes
 ~: Volume exceeds capacity \$: Delay exceeds 300s +: Computation Not Defined *: All major volume in platoon

4: Scottsdale Road & Tierra Buena Lane

08/17/2022

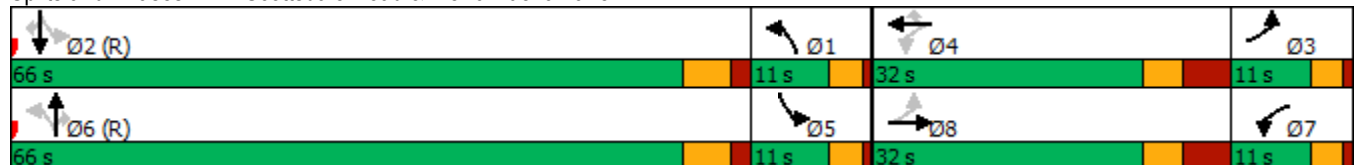


Lane Group	EBL	EBT	WBL	WBT	WBR	NBL	NBT	NBR	SBL	SBT	SBR
Lane Configurations	↘	↘	↘	↗	↗	↘	↑↑↑	↗	↘	↑↑↑	↗
Traffic Volume (vph)	11	3	84	1	109	13	810	75	117	1382	17
Future Volume (vph)	11	3	84	1	109	13	810	75	117	1382	17
Turn Type	pm+pt	NA	pm+pt	NA	Perm	pm+pt	NA	Perm	pm+pt	NA	Perm
Protected Phases	3	8	7	4		1	6		5	2	
Permitted Phases	8		4		4	6		6	2		2
Detector Phase	3	8	7	4	4	1	6	6	5	2	2
Switch Phase											
Minimum Initial (s)	4.0	7.0	4.0	7.0	7.0	4.0	10.0	10.0	4.0	10.0	10.0
Minimum Split (s)	9.5	43.0	9.5	43.0	43.0	9.5	36.0	36.0	9.5	36.0	36.0
Total Split (s)	11.0	32.0	11.0	32.0	32.0	11.0	66.0	66.0	11.0	66.0	66.0
Total Split (%)	9.2%	26.7%	9.2%	26.7%	26.7%	9.2%	55.0%	55.0%	9.2%	55.0%	55.0%
Yellow Time (s)	3.0	3.7	3.0	3.7	3.7	3.0	4.3	4.3	3.0	4.3	4.3
All-Red Time (s)	1.0	4.3	1.0	4.3	4.3	1.0	1.7	1.7	1.0	1.7	1.7
Lost Time Adjust (s)	0.0	0.0	0.0	0.0	0.0	0.0	0.0	0.0	0.0	0.0	0.0
Total Lost Time (s)	4.0	8.0	4.0	8.0	8.0	4.0	6.0	6.0	4.0	6.0	6.0
Lead/Lag	Lag	Lead	Lag	Lead	Lead	Lag	Lead	Lead	Lag	Lead	Lead
Lead-Lag Optimize?	Yes	Yes	Yes	Yes	Yes	Yes	Yes	Yes	Yes	Yes	Yes
Recall Mode	None	None	None	None	None	None	C-Min	C-Min	None	C-Min	C-Min
Act Effct Green (s)	9.1	7.0	15.1	9.5	9.5	89.4	82.8	82.8	96.8	91.4	91.4
Actuated g/C Ratio	0.08	0.06	0.13	0.08	0.08	0.74	0.69	0.69	0.81	0.76	0.76
v/c Ratio	0.09	0.17	0.45	0.01	0.51	0.06	0.25	0.07	0.24	0.39	0.01
Control Delay	45.1	30.2	54.5	49.0	16.9	11.2	28.0	18.3	7.4	12.9	0.1
Queue Delay	0.0	0.0	0.0	0.0	0.0	0.0	0.0	0.0	0.0	0.0	0.0
Total Delay	45.1	30.2	54.5	49.0	16.9	11.2	28.0	18.3	7.4	12.9	0.1
LOS	D	C	D	D	B	B	C	B	A	B	A
Approach Delay		35.9		33.3			27.0			12.3	
Approach LOS		D		C			C			B	

Intersection Summary

Cycle Length: 120
 Actuated Cycle Length: 120
 Offset: 20 (17%), Referenced to phase 2:SBTL and 6:NBT, Start of 1st Green
 Natural Cycle: 100
 Control Type: Actuated-Coordinated
 Maximum v/c Ratio: 0.51
 Intersection Signal Delay: 19.1
 Intersection Capacity Utilization 56.4%
 Analysis Period (min) 15
 Intersection LOS: B
 ICU Level of Service B

Splits and Phases: 4: Scottsdale Road & Tierra Buena Lane



4: Scottsdale Road & Tierra Buena Lane

08/17/2022



Movement	EBL	EBT	EBR	WBL	WBT	WBR	NBL	NBT	NBR	SBL	SBT	SBR
Lane Configurations	↖	↗		↖	↖	↖	↖	↖↖↖	↖	↖	↖↖↖	↖
Traffic Volume (veh/h)	11	3	15	84	1	109	13	810	75	117	1382	17
Future Volume (veh/h)	11	3	15	84	1	109	13	810	75	117	1382	17
Initial Q (Qb), veh	0	0	0	0	0	0	0	0	0	0	0	0
Ped-Bike Adj(A_pbT)	1.00		1.00	1.00		1.00	1.00		1.00	1.00		1.00
Parking Bus, Adj	1.00	1.00	1.00	1.00	1.00	1.00	1.00	1.00	1.00	1.00	1.00	1.00
Work Zone On Approach		No			No			No			No	
Adj Sat Flow, veh/h/ln	1870	1870	1870	1870	1870	1870	1870	1870	1870	1870	1870	1870
Adj Flow Rate, veh/h	12	3	16	91	1	118	14	880	82	127	1502	18
Peak Hour Factor	0.92	0.92	0.92	0.92	0.92	0.92	0.92	0.92	0.92	0.92	0.92	0.92
Percent Heavy Veh, %	2	2	2	2	2	2	2	2	2	2	2	2
Cap, veh/h	153	15	79	203	170	144	785	1051	326	987	1572	488
Arrive On Green	0.01	0.06	0.06	0.04	0.09	0.09	0.81	0.41	0.41	1.00	0.62	0.62
Sat Flow, veh/h	1781	256	1368	1781	1870	1585	1781	5106	1585	1781	5106	1585
Grp Volume(v), veh/h	12	0	19	91	1	118	14	880	82	127	1502	18
Grp Sat Flow(s),veh/h/ln	1781	0	1624	1781	1870	1585	1781	1702	1585	1781	1702	1585
Q Serve(g_s), s	0.0	0.0	1.3	0.0	0.1	8.8	0.0	18.6	4.1	0.0	33.0	0.5
Cycle Q Clear(g_c), s	0.0	0.0	1.3	0.0	0.1	8.8	0.0	18.6	4.1	0.0	33.0	0.5
Prop In Lane	1.00		0.84	1.00		1.00	1.00		1.00	1.00		1.00
Lane Grp Cap(c), veh/h	153	0	94	203	170	144	785	1051	326	987	1572	488
V/C Ratio(X)	0.08	0.00	0.20	0.45	0.01	0.82	0.02	0.84	0.25	0.13	0.96	0.04
Avail Cap(c_a), veh/h	237	0	325	229	374	317	785	2553	793	987	2553	793
HCM Platoon Ratio	1.00	1.00	1.00	1.00	1.00	1.00	2.00	2.00	2.00	2.00	2.00	2.00
Upstream Filter(I)	1.00	0.00	1.00	1.00	1.00	1.00	0.87	0.87	0.87	1.00	1.00	1.00
Uniform Delay (d), s/veh	52.6	0.0	53.9	52.8	49.6	53.6	6.6	33.5	29.2	0.0	22.3	16.1
Incr Delay (d2), s/veh	0.1	0.0	0.4	0.6	0.0	4.3	0.0	7.0	1.6	0.0	14.4	0.1
Initial Q Delay(d3),s/veh	0.0	0.0	0.0	0.0	0.0	0.0	0.0	0.0	0.0	0.0	0.0	0.0
%ile BackOfQ(50%),veh/ln	0.3	0.0	0.6	2.7	0.0	3.7	0.1	6.4	1.6	0.0	9.0	0.2
Unsig. Movement Delay, s/veh												
LnGrp Delay(d),s/veh	52.6	0.0	54.3	53.4	49.6	57.9	6.6	40.5	30.8	0.0	36.7	16.2
LnGrp LOS	D	A	D	D	D	E	A	D	C	A	D	B
Approach Vol, veh/h		31			210			976			1647	
Approach Delay, s/veh		53.6			55.9			39.2			33.6	
Approach LOS		D			E			D			C	
Timer - Assigned Phs	1	2	3	4	5	6	7	8				
Phs Duration (G+Y+Rc), s	52.8	42.9	5.3	18.9	65.1	30.7	9.3	15.0				
Change Period (Y+Rc), s	* 4	6.0	* 4	8.0	* 4	6.0	* 4	8.0				
Max Green Setting (Gmax), s	* 7	60.0	* 7	24.0	* 7	60.0	* 7	24.0				
Max Q Clear Time (g_c+I1), s	2.0	35.0	2.0	10.8	2.0	20.6	2.0	3.3				
Green Ext Time (p_c), s	0.0	2.0	0.0	0.1	0.1	4.1	0.0	0.0				

Intersection Summary

HCM 6th Ctrl Delay	37.4
HCM 6th LOS	D

Notes

- User approved pedestrian interval to be less than phase max green.
- * HCM 6th computational engine requires equal clearance times for the phases crossing the barrier.

5: Scottsdale Road & Kierland Boulevard/Greenway Hayden Loop

08/17/2022



Movement	EBL	EBT	EBR	WBL	WBT	WBR	NBL	NBT	NBR	SBL	SBT	SBR
Lane Configurations	↔↔	↑↑	↗	↔↔	↑↑↔		↔↔	↑↑↑	↗	↔↔	↑↑↑	↗
Traffic Volume (veh/h)	51	129	39	277	173	45	39	819	374	141	1151	165
Future Volume (veh/h)	51	129	39	277	173	45	39	819	374	141	1151	165
Initial Q (Qb), veh	0	0	0	0	0	0	0	0	0	0	0	0
Ped-Bike Adj(A_pbT)	1.00		1.00	1.00		1.00	1.00		1.00	1.00		1.00
Parking Bus, Adj	1.00	1.00	1.00	1.00	1.00	1.00	1.00	1.00	1.00	1.00	1.00	1.00
Work Zone On Approach		No			No			No			No	
Adj Sat Flow, veh/h/ln	1870	1870	1870	1870	1870	1870	1870	1870	1870	1870	1870	1870
Adj Flow Rate, veh/h	55	140	42	301	188	49	42	890	407	153	1251	179
Peak Hour Factor	0.92	0.92	0.92	0.92	0.92	0.92	0.92	0.92	0.92	0.92	0.92	0.92
Percent Heavy Veh, %	2	2	2	2	2	2	2	2	2	2	2	2
Cap, veh/h	319	207	92	369	294	72	719	1126	350	1463	2225	691
Arrive On Green	0.09	0.06	0.06	0.04	0.02	0.02	0.21	0.22	0.22	0.85	0.87	0.87
Sat Flow, veh/h	3456	3554	1585	3456	4088	1005	3456	5106	1585	3456	5106	1585
Grp Volume(v), veh/h	55	140	42	301	155	82	42	890	407	153	1251	179
Grp Sat Flow(s),veh/h/ln	1728	1777	1585	1728	1702	1689	1728	1702	1585	1728	1702	1585
Q Serve(g_s), s	1.8	4.6	2.1	10.4	5.4	5.8	1.2	19.7	19.6	0.9	7.4	2.2
Cycle Q Clear(g_c), s	1.8	4.6	2.1	10.4	5.4	5.8	1.2	19.7	19.6	0.9	7.4	2.2
Prop In Lane	1.00		1.00	1.00		0.60	1.00		1.00	1.00		1.00
Lane Grp Cap(c), veh/h	319	207	92	369	245	122	719	1126	350	1463	2225	691
V/C Ratio(X)	0.17	0.68	0.45	0.82	0.63	0.68	0.06	0.79	1.16	0.10	0.56	0.26
Avail Cap(c_a), veh/h	319	397	177	703	860	427	719	2055	638	1463	2225	691
HCM Platoon Ratio	1.00	1.00	1.00	0.33	0.33	0.33	1.00	1.00	1.00	2.00	2.00	2.00
Upstream Filter(I)	1.00	1.00	1.00	0.87	0.87	0.87	0.92	0.92	0.92	0.93	0.93	0.93
Uniform Delay (d), s/veh	50.2	55.4	25.0	56.7	57.0	57.2	38.1	44.1	25.8	5.4	4.8	4.5
Incr Delay (d2), s/veh	0.1	1.4	1.3	1.5	0.9	2.1	0.0	5.2	99.0	0.0	1.0	0.8
Initial Q Delay(d3),s/veh	0.0	0.0	0.0	0.0	0.0	0.0	0.0	0.0	0.0	0.0	0.0	0.0
%ile BackOfQ(50%),veh/ln	0.8	2.1	1.2	4.8	2.4	2.6	0.5	8.6	16.9	0.3	1.7	0.8
Unsig. Movement Delay, s/veh												
LnGrp Delay(d),s/veh	50.3	56.8	26.3	58.2	57.9	59.3	38.1	49.4	124.7	5.4	5.8	5.3
LnGrp LOS	D	E	C	E	E	E	D	D	F	A	A	A
Approach Vol, veh/h		237			538			1339			1583	
Approach Delay, s/veh		49.9			58.3			71.9			5.7	
Approach LOS		D			E			E			A	
Timer - Assigned Phs	1	2	3	4	5	6	7	8				
Phs Duration (G+Y+Rc), s	31.0	58.0	16.7	14.3	56.8	32.2	18.4	12.6				
Change Period (Y+Rc), s	6.0	5.7	* 5.6	* 5.7	6.0	5.7	5.6	* 5.6				
Max Green Setting (Gmax), s	7.0	52.3	* 7.7	* 30	11.0	48.3	24.4	* 13				
Max Q Clear Time (g_c+I1), s	3.2	9.4	3.8	7.8	2.9	21.7	12.4	6.6				
Green Ext Time (p_c), s	0.0	6.8	0.0	0.8	0.1	4.7	0.4	0.3				

Intersection Summary

HCM 6th Ctrl Delay	40.2
HCM 6th LOS	D

Notes

User approved pedestrian interval to be less than phase max green.
 * HCM 6th computational engine requires equal clearance times for the phases crossing the barrier.

6: Scottsdale Road & Greenway Parkway/Butherus Drive

08/17/2022

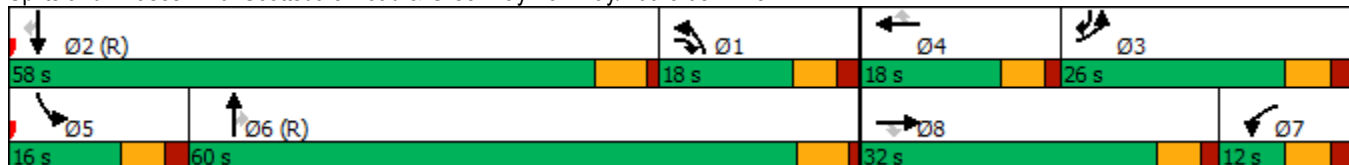


Lane Group	EBL	EBT	EBR	WBL	WBT	WBR	NBL	NBT	NBR	SBL	SBT	SBR
Lane Configurations	↔↔	↕↔	↗	↔↔	↕↕	↗	↔↔	↕↕↕	↗	↔↔	↕↕↕	↗
Traffic Volume (vph)	306	376	323	86	63	32	166	912	267	132	1198	118
Future Volume (vph)	306	376	323	86	63	32	166	912	267	132	1198	118
Turn Type	Prot	NA	pm+ov	Prot	NA	Perm	Prot	NA	Perm	Prot	NA	pm+ov
Protected Phases	3	8	1	7	4		1	6		5	2	3
Permitted Phases			8			4			6			2
Detector Phase	3	8	1	7	4	4	1	6	6	5	2	3
Switch Phase												
Minimum Initial (s)	5.0	7.0	5.0	5.0	7.0	7.0	5.0	10.0	10.0	5.0	10.0	5.0
Minimum Split (s)	11.0	13.2	11.0	11.0	13.2	13.2	11.0	16.0	16.0	11.0	16.0	11.0
Total Split (s)	26.0	32.0	18.0	12.0	18.0	18.0	18.0	60.0	60.0	16.0	58.0	26.0
Total Split (%)	21.7%	26.7%	15.0%	10.0%	15.0%	15.0%	15.0%	50.0%	50.0%	13.3%	48.3%	21.7%
Yellow Time (s)	4.0	4.0	4.0	4.0	4.0	4.0	4.0	4.7	4.7	4.0	4.7	4.0
All-Red Time (s)	2.0	1.5	2.0	2.0	1.5	1.5	2.0	1.0	1.0	2.0	1.0	2.0
Lost Time Adjust (s)	0.0	0.0	0.0	0.0	0.0	0.0	0.0	0.0	0.0	0.0	0.0	0.0
Total Lost Time (s)	6.0	5.5	6.0	6.0	5.5	5.5	6.0	5.7	5.7	6.0	5.7	6.0
Lead/Lag	Lag	Lead	Lag	Lag	Lead	Lead	Lag	Lag	Lag	Lead	Lead	Lag
Lead-Lag Optimize?	Yes	Yes	Yes	Yes	Yes	Yes	Yes	Yes	Yes	Yes	Yes	Yes
Recall Mode	None	None	None	None	None	None	None	C-Min	C-Min	None	C-Min	None
Act Effct Green (s)	24.6	22.7	40.2	6.8	7.4	7.4	12.0	58.3	58.3	8.9	55.3	85.6
Actuated g/C Ratio	0.20	0.19	0.34	0.06	0.06	0.06	0.10	0.49	0.49	0.07	0.46	0.71
v/c Ratio	0.47	0.82	0.41	0.48	0.31	0.11	0.53	0.40	0.33	0.56	0.56	0.11
Control Delay	44.6	55.2	13.3	63.1	57.5	0.7	56.1	21.2	7.7	64.5	13.9	0.8
Queue Delay	0.0	0.0	0.0	0.0	0.0	0.0	0.0	0.0	0.0	0.0	0.0	0.0
Total Delay	44.6	55.2	13.3	63.1	57.5	0.7	56.1	21.2	7.7	64.5	13.9	0.8
LOS	D	E	B	E	E	A	E	C	A	E	B	A
Approach Delay		43.1			50.0			22.8			17.4	
Approach LOS		D			D			C			B	

Intersection Summary

Cycle Length: 120
 Actuated Cycle Length: 120
 Offset: 53 (44%), Referenced to phase 2:SBT and 6:NBT, Start of 1st Green
 Natural Cycle: 65
 Control Type: Actuated-Coordinated
 Maximum v/c Ratio: 0.82
 Intersection Signal Delay: 27.2
 Intersection Capacity Utilization 65.2%
 Analysis Period (min) 15
 Intersection LOS: C
 ICU Level of Service C

Splits and Phases: 6: Scottsdale Road & Greenway Parkway/Butherus Drive



6: Scottsdale Road & Greenway Parkway/Butherus Drive

08/17/2022



Movement	EBL	EBT	EBR	WBL	WBT	WBR	NBL	NBT	NBR	SBL	SBT	SBR
Lane Configurations	↔↔	↕↔	↔↔	↔↔	↕↕	↔↔	↔↔	↕↕↕	↔↔	↔↔	↕↕↕	↔↔
Traffic Volume (veh/h)	306	376	323	86	63	32	166	912	267	132	1198	118
Future Volume (veh/h)	306	376	323	86	63	32	166	912	267	132	1198	118
Initial Q (Qb), veh	0	0	0	0	0	0	0	0	0	0	0	0
Ped-Bike Adj(A_pbT)	1.00		1.00	1.00		1.00	1.00		1.00	1.00		1.00
Parking Bus, Adj	1.00	1.00	1.00	1.00	1.00	1.00	1.00	1.00	1.00	1.00	1.00	1.00
Work Zone On Approach		No			No			No			No	
Adj Sat Flow, veh/h/ln	1870	1870	1870	1870	1870	1870	1870	1870	1870	1870	1870	1870
Adj Flow Rate, veh/h	333	556	253	93	68	35	180	991	0	143	1302	128
Peak Hour Factor	0.92	0.92	0.92	0.92	0.92	0.92	0.92	0.92	0.92	0.92	0.92	0.92
Percent Heavy Veh, %	2	2	2	2	2	2	2	2	2	2	2	2
Cap, veh/h	563	655	754	143	207	92	1040	2712		196	1478	709
Arrive On Green	0.16	0.17	0.17	0.04	0.06	0.06	0.30	0.53	0.00	0.11	0.58	0.58
Sat Flow, veh/h	3563	3741	1585	3456	3554	1585	3456	5106	1585	3456	5106	1585
Grp Volume(v), veh/h	333	556	253	93	68	35	180	991	0	143	1302	128
Grp Sat Flow(s),veh/h/ln	1781	1870	1585	1728	1777	1585	1728	1702	1585	1728	1702	1585
Q Serve(g_s), s	10.4	17.3	0.0	3.2	2.2	2.1	4.6	13.5	0.0	4.8	26.3	0.0
Cycle Q Clear(g_c), s	10.4	17.3	0.0	3.2	2.2	2.1	4.6	13.5	0.0	4.8	26.3	0.0
Prop In Lane	1.00		1.00	1.00		1.00	1.00		1.00	1.00		1.00
Lane Grp Cap(c), veh/h	563	655	754	143	207	92	1040	2712		196	1478	709
V/C Ratio(X)	0.59	0.85	0.34	0.65	0.33	0.38	0.17	0.37		0.73	0.88	0.18
Avail Cap(c_a), veh/h	594	826	827	173	370	165	1040	2712		288	2225	941
HCM Platoon Ratio	1.00	1.00	1.00	1.00	1.00	1.00	1.00	1.00	1.00	2.00	2.00	2.00
Upstream Filter(I)	1.00	1.00	1.00	1.00	1.00	1.00	1.00	1.00	0.00	0.88	0.88	0.88
Uniform Delay (d), s/veh	46.9	48.0	19.6	56.7	54.2	38.2	30.9	16.4	0.0	52.3	23.5	11.4
Incr Delay (d2), s/veh	0.9	5.7	0.1	3.5	0.3	0.9	0.0	0.4	0.0	1.7	7.0	0.5
Initial Q Delay(d3),s/veh	0.0	0.0	0.0	0.0	0.0	0.0	0.0	0.0	0.0	0.0	0.0	0.0
%ile BackOfQ(50%),veh/ln	4.6	8.3	4.2	1.4	1.0	1.0	1.9	5.0	0.0	2.0	7.1	1.3
Unsig. Movement Delay, s/veh												
LnGrp Delay(d),s/veh	47.8	53.7	19.7	60.1	54.6	39.2	31.0	16.7	0.0	54.0	30.5	11.9
LnGrp LOS	D	D	B	E	D	D	C	B		D	C	B
Approach Vol, veh/h		1142			196			1171			1573	
Approach Delay, s/veh		44.4			54.5			18.9			31.1	
Approach LOS		D			D			B			C	
Timer - Assigned Phs	1	2	3	4	5	6	7	8				
Phs Duration (G+Y+Rc), s	42.1	40.4	25.0	12.5	12.8	69.7	11.0	26.5				
Change Period (Y+Rc), s	6.0	5.7	6.0	5.5	6.0	* 6	6.0	5.5				
Max Green Setting (Gmax), s	12.0	52.3	20.0	12.5	10.0	* 54	6.0	26.5				
Max Q Clear Time (g_c+I1), s	6.6	28.3	12.4	4.2	6.8	15.5	5.2	19.3				
Green Ext Time (p_c), s	0.1	6.4	0.4	0.1	0.1	4.6	0.0	1.7				

Intersection Summary

HCM 6th Ctrl Delay	32.5
HCM 6th LOS	C

Notes

- User approved pedestrian interval to be less than phase max green.
- User approved volume balancing among the lanes for turning movement.
- * HCM 6th computational engine requires equal clearance times for the phases crossing the barrier.

Intersection						
Int Delay, s/veh	0.4					
Movement	EBT	EBR	WBL	WBT	NBL	NBR
Lane Configurations	↔			↑		↗
Traffic Vol, veh/h	279	57	0	259	0	27
Future Vol, veh/h	279	57	0	259	0	27
Conflicting Peds, #/hr	0	0	0	0	0	0
Sign Control	Free	Free	Free	Free	Stop	Stop
RT Channelized	-	None	-	None	-	None
Storage Length	-	-	-	-	-	0
Veh in Median Storage, #	0	-	-	0	0	-
Grade, %	0	-	-	0	0	-
Peak Hour Factor	92	92	92	92	92	92
Heavy Vehicles, %	2	2	2	2	2	2
Mvmt Flow	303	62	0	282	0	29
Major/Minor	Major1	Major2	Minor1			
Conflicting Flow All	0	0	-	-	-	334
Stage 1	-	-	-	-	-	-
Stage 2	-	-	-	-	-	-
Critical Hdwy	-	-	-	-	-	6.22
Critical Hdwy Stg 1	-	-	-	-	-	-
Critical Hdwy Stg 2	-	-	-	-	-	-
Follow-up Hdwy	-	-	-	-	-	3.318
Pot Cap-1 Maneuver	-	-	0	-	0	708
Stage 1	-	-	0	-	0	-
Stage 2	-	-	0	-	0	-
Platoon blocked, %	-	-	-	-	-	-
Mov Cap-1 Maneuver	-	-	-	-	-	708
Mov Cap-2 Maneuver	-	-	-	-	-	-
Stage 1	-	-	-	-	-	-
Stage 2	-	-	-	-	-	-
Approach	EB	WB	NB			
HCM Control Delay, s	0	0	10.3			
HCM LOS				B		
Minor Lane/Major Mvmt	NBLn1	EBT	EBR	WBT		
Capacity (veh/h)	708	-	-	-		
HCM Lane V/C Ratio	0.041	-	-	-		
HCM Control Delay (s)	10.3	-	-	-		
HCM Lane LOS	B	-	-	-		
HCM 95th %tile Q(veh)	0.1	-	-	-		

8: Driveway C & Paradise Lane

08/17/2022

Intersection												
Int Delay, s/veh	3.5											
Movement	EBL	EBT	EBR	WBL	WBT	WBR	NBL	NBT	NBR	SBL	SBT	SBR
Lane Configurations												
Traffic Vol, veh/h	28	235	26	29	160	16	59	0	36	14	0	30
Future Vol, veh/h	28	235	26	29	160	16	59	0	36	14	0	30
Conflicting Peds, #/hr	0	0	0	0	0	0	0	0	0	0	0	0
Sign Control	Free	Free	Free	Free	Free	Free	Stop	Stop	Stop	Stop	Stop	Stop
RT Channelized	-	-	None	-	-	None	-	-	None	-	-	None
Storage Length	100	-	-	100	-	-	-	-	-	-	-	-
Veh in Median Storage, #	-	0	-	-	0	-	-	0	-	-	0	-
Grade, %	-	0	-	-	0	-	-	0	-	-	0	-
Peak Hour Factor	92	92	92	92	92	92	92	92	92	92	92	92
Heavy Vehicles, %	2	2	2	2	2	2	2	2	2	2	2	2
Mvmt Flow	30	255	28	32	174	17	64	0	39	15	0	33

Major/Minor	Major1			Major2			Minor1			Minor2		
Conflicting Flow All	191	0	0	283	0	0	592	584	269	596	590	183
Stage 1	-	-	-	-	-	-	329	329	-	247	247	-
Stage 2	-	-	-	-	-	-	263	255	-	349	343	-
Critical Hdwy	4.12	-	-	4.12	-	-	7.12	6.52	6.22	7.12	6.52	6.22
Critical Hdwy Stg 1	-	-	-	-	-	-	6.12	5.52	-	6.12	5.52	-
Critical Hdwy Stg 2	-	-	-	-	-	-	6.12	5.52	-	6.12	5.52	-
Follow-up Hdwy	2.218	-	-	2.218	-	-	3.518	4.018	3.318	3.518	4.018	3.318
Pot Cap-1 Maneuver	1383	-	-	1310	-	-	461	449	883	458	445	859
Stage 1	-	-	-	-	-	-	763	682	-	757	702	-
Stage 2	-	-	-	-	-	-	742	696	-	741	671	-
Platoon blocked, %		-	-	1	-	-	1	1	1	1	1	
Mov Cap-1 Maneuver	1383	-	-	1310	-	-	429	429	883	422	425	859
Mov Cap-2 Maneuver	-	-	-	-	-	-	429	429	-	422	425	-
Stage 1	-	-	-	-	-	-	746	667	-	740	685	-
Stage 2	-	-	-	-	-	-	696	679	-	693	656	-

Approach	EB			WB			NB			SB		
HCM Control Delay, s	0.7			1.1			13.4			11		
HCM LOS							B			B		

Minor Lane/Major Mvmt	NBLn1	EBL	EBT	EBR	WBL	WBT	WBR	SBLn1
Capacity (veh/h)	533	1383	-	-	1310	-	-	646
HCM Lane V/C Ratio	0.194	0.022	-	-	0.024	-	-	0.074
HCM Control Delay (s)	13.4	7.7	-	-	7.8	-	-	11
HCM Lane LOS	B	A	-	-	A	-	-	B
HCM 95th %tile Q(veh)	0.7	0.1	-	-	0.1	-	-	0.2

Intersection						
Int Delay, s/veh	4.3					
Movement	EBT	EBR	WBL	WBT	NBL	NBR
Lane Configurations						
Traffic Vol, veh/h	202	82	43	118	92	153
Future Vol, veh/h	202	82	43	118	92	153
Conflicting Peds, #/hr	0	0	0	0	0	0
Sign Control	Free	Free	Free	Free	Stop	Stop
RT Channelized	-	None	-	None	-	None
Storage Length	-	-	100	-	80	0
Veh in Median Storage, #	0	-	-	0	0	-
Grade, %	0	-	-	0	0	-
Peak Hour Factor	92	92	92	92	92	92
Heavy Vehicles, %	2	2	2	2	2	2
Mvmt Flow	220	89	47	128	100	166

Major/Minor	Major1	Major2	Minor1		
Conflicting Flow All	0	0	309	0	487
Stage 1	-	-	-	-	265
Stage 2	-	-	-	-	222
Critical Hdwy	-	-	4.12	-	6.42
Critical Hdwy Stg 1	-	-	-	-	5.42
Critical Hdwy Stg 2	-	-	-	-	5.42
Follow-up Hdwy	-	-	2.218	-	3.518
Pot Cap-1 Maneuver	-	-	1269	-	580
Stage 1	-	-	-	-	828
Stage 2	-	-	-	-	815
Platoon blocked, %	-	-	1	-	1
Mov Cap-1 Maneuver	-	-	1269	-	559
Mov Cap-2 Maneuver	-	-	-	-	622
Stage 1	-	-	-	-	828
Stage 2	-	-	-	-	785

Approach	EB	WB	NB
HCM Control Delay, s	0	2.1	10.8
HCM LOS			B

Minor Lane/Major Mvmt	NBLn1	NBLn2	EBT	EBR	WBL	WBT
Capacity (veh/h)	622	867	-	-	1269	-
HCM Lane V/C Ratio	0.161	0.192	-	-	0.037	-
HCM Control Delay (s)	11.9	10.1	-	-	7.9	-
HCM Lane LOS	B	B	-	-	A	-
HCM 95th %tile Q(veh)	0.6	0.7	-	-	0.1	-

Intersection						
Int Delay, s/veh	2.7					
Movement	EBL	EBR	NBL	NBT	SBT	SBR
Lane Configurations						
Traffic Vol, veh/h	65	35	14	181	97	33
Future Vol, veh/h	65	35	14	181	97	33
Conflicting Peds, #/hr	0	0	0	0	0	0
Sign Control	Stop	Stop	Free	Free	Free	Free
RT Channelized	-	None	-	None	-	None
Storage Length	0	-	100	-	-	-
Veh in Median Storage, #	0	-	-	0	0	-
Grade, %	0	-	-	0	0	-
Peak Hour Factor	92	92	92	92	92	92
Heavy Vehicles, %	2	2	2	2	2	2
Mvmt Flow	71	38	15	197	105	36

Major/Minor	Minor2	Major1		Major2	
Conflicting Flow All	350	123	141	0	0
Stage 1	123	-	-	-	-
Stage 2	227	-	-	-	-
Critical Hdwy	6.42	6.22	4.12	-	-
Critical Hdwy Stg 1	5.42	-	-	-	-
Critical Hdwy Stg 2	5.42	-	-	-	-
Follow-up Hdwy	3.518	3.318	2.218	-	-
Pot Cap-1 Maneuver	647	928	1442	-	-
Stage 1	902	-	-	-	-
Stage 2	811	-	-	-	-
Platoon blocked, %				-	-
Mov Cap-1 Maneuver	641	928	1442	-	-
Mov Cap-2 Maneuver	678	-	-	-	-
Stage 1	893	-	-	-	-
Stage 2	811	-	-	-	-

Approach	EB	NB	SB
HCM Control Delay, s	10.6	0.5	0
HCM LOS	B		

Minor Lane/Major Mvmt	NBL	NBT	EBLn1	SBT	SBR
Capacity (veh/h)	1442	-	749	-	-
HCM Lane V/C Ratio	0.011	-	0.145	-	-
HCM Control Delay (s)	7.5	-	10.6	-	-
HCM Lane LOS	A	-	B	-	-
HCM 95th %tile Q(veh)	0	-	0.5	-	-

Intersection						
Int Delay, s/veh	0.9					
Movement	WBL	WBR	NBT	NBR	SBL	SBT
Lane Configurations	↙	↗	↖		↙	↗
Traffic Vol, veh/h	6	9	181	29	24	105
Future Vol, veh/h	6	9	181	29	24	105
Conflicting Peds, #/hr	0	0	0	0	0	0
Sign Control	Stop	Stop	Free	Free	Free	Free
RT Channelized	-	None	-	None	-	None
Storage Length	75	0	-	-	100	-
Veh in Median Storage, #	0	-	0	-	-	0
Grade, %	0	-	0	-	-	0
Peak Hour Factor	92	92	92	92	92	92
Heavy Vehicles, %	2	2	2	2	2	2
Mvmt Flow	7	10	197	32	26	114

Major/Minor	Minor1	Major1	Major2		
Conflicting Flow All	379	213	0	0	229
Stage 1	213	-	-	-	-
Stage 2	166	-	-	-	-
Critical Hdwy	6.42	6.22	-	-	4.12
Critical Hdwy Stg 1	5.42	-	-	-	-
Critical Hdwy Stg 2	5.42	-	-	-	-
Follow-up Hdwy	3.518	3.318	-	-	2.218
Pot Cap-1 Maneuver	623	827	-	-	1339
Stage 1	823	-	-	-	-
Stage 2	863	-	-	-	-
Platoon blocked, %			-	-	-
Mov Cap-1 Maneuver	611	827	-	-	1339
Mov Cap-2 Maneuver	660	-	-	-	-
Stage 1	823	-	-	-	-
Stage 2	847	-	-	-	-

Approach	WB	NB	SB
HCM Control Delay, s	9.8	0	1.4
HCM LOS	A		

Minor Lane/Major Mvmt	NBT	NBRWBLn1	WBLn2	SBL	SBT
Capacity (veh/h)	-	-	660	827	1339
HCM Lane V/C Ratio	-	-	0.01	0.012	0.019
HCM Control Delay (s)	-	-	10.5	9.4	7.7
HCM Lane LOS	-	-	B	A	A
HCM 95th %tile Q(veh)	-	-	0	0	0.1

Intersection												
Int Delay, s/veh	4.5											
Movement	EBL	EBT	EBR	WBL	WBT	WBR	NBL	NBT	NBR	SBL	SBT	SBR
Lane Configurations		↕			↕		↕	↕		↕	↕	
Traffic Vol, veh/h	105	0	25	0	0	0	25	110	2	1	97	14
Future Vol, veh/h	105	0	25	0	0	0	25	110	2	1	97	14
Conflicting Peds, #/hr	0	0	0	0	0	0	0	0	0	0	0	0
Sign Control	Stop	Stop	Stop	Stop	Stop	Stop	Free	Free	Free	Free	Free	Free
RT Channelized	-	-	None	-	-	None	-	-	None	-	-	None
Storage Length	-	-	-	-	-	-	100	-	-	100	-	-
Veh in Median Storage, #	-	0	-	-	0	-	-	0	-	-	0	-
Grade, %	-	0	-	-	0	-	-	0	-	-	0	-
Peak Hour Factor	92	92	92	92	92	92	92	92	92	92	92	92
Heavy Vehicles, %	2	2	2	2	2	2	2	2	2	2	2	2
Mvmt Flow	114	0	27	0	0	0	27	120	2	1	105	15

Major/Minor	Minor2		Minor1		Major1			Major2				
Conflicting Flow All	290	291	113	303	297	121	120	0	0	122	0	0
Stage 1	115	115	-	175	175	-	-	-	-	-	-	-
Stage 2	175	176	-	128	122	-	-	-	-	-	-	-
Critical Hdwy	7.12	6.52	6.22	7.12	6.52	6.22	4.12	-	-	4.12	-	-
Critical Hdwy Stg 1	6.12	5.52	-	6.12	5.52	-	-	-	-	-	-	-
Critical Hdwy Stg 2	6.12	5.52	-	6.12	5.52	-	-	-	-	-	-	-
Follow-up Hdwy	3.518	4.018	3.318	3.518	4.018	3.318	2.218	-	-	2.218	-	-
Pot Cap-1 Maneuver	662	619	940	649	615	930	1468	-	-	1465	-	-
Stage 1	890	800	-	827	754	-	-	-	-	-	-	-
Stage 2	827	753	-	876	795	-	-	-	-	-	-	-
Platoon blocked, %								-	-	-	-	-
Mov Cap-1 Maneuver	652	607	940	621	603	930	1468	-	-	1465	-	-
Mov Cap-2 Maneuver	652	607	-	621	603	-	-	-	-	-	-	-
Stage 1	874	799	-	812	740	-	-	-	-	-	-	-
Stage 2	812	739	-	850	794	-	-	-	-	-	-	-

Approach	EB		WB		NB		SB	
HCM Control Delay, s	11.5		0		1.4		0.1	
HCM LOS	B		A					

Minor Lane/Major Mvmt	NBL	NBT	NBR	EBLn1WBLn1	SBL	SBT	SBR
Capacity (veh/h)	1468	-	-	693	-	1465	-
HCM Lane V/C Ratio	0.019	-	-	0.204	-	0.001	-
HCM Control Delay (s)	7.5	-	-	11.5	0	7.5	-
HCM Lane LOS	A	-	-	B	A	A	-
HCM 95th %tile Q(veh)	0.1	-	-	0.8	-	0	-

Intersection												
Int Delay, s/veh	3											
Movement	EBL	EBT	EBR	WBL	WBT	WBR	NBL	NBT	NBR	SBL	SBT	SBR
Lane Configurations												
Traffic Vol, veh/h	45	142	6	0	151	33	10	0	11	6	0	81
Future Vol, veh/h	45	142	6	0	151	33	10	0	11	6	0	81
Conflicting Peds, #/hr	0	0	0	0	0	0	0	0	0	0	0	0
Sign Control	Free	Free	Free	Free	Free	Free	Stop	Stop	Stop	Stop	Stop	Stop
RT Channelized	-	-	None	-	-	None	-	-	None	-	-	None
Storage Length	100	-	-	100	-	-	-	-	-	-	-	-
Veh in Median Storage, #	-	0	-	-	0	-	-	0	-	-	0	-
Grade, %	-	0	-	-	0	-	-	0	-	-	0	-
Peak Hour Factor	92	92	92	92	92	92	92	92	92	92	92	92
Heavy Vehicles, %	2	2	2	2	2	2	2	2	2	2	2	2
Mvmt Flow	49	154	7	0	164	36	11	0	12	7	0	88

Major/Minor	Major1			Major2			Minor1			Minor2		
Conflicting Flow All	200	0	0	161	0	0	482	456	158	444	441	182
Stage 1	-	-	-	-	-	-	256	256	-	182	182	-
Stage 2	-	-	-	-	-	-	226	200	-	262	259	-
Critical Hdwy	4.12	-	-	4.12	-	-	7.12	6.52	6.22	7.12	6.52	6.22
Critical Hdwy Stg 1	-	-	-	-	-	-	6.12	5.52	-	6.12	5.52	-
Critical Hdwy Stg 2	-	-	-	-	-	-	6.12	5.52	-	6.12	5.52	-
Follow-up Hdwy	2.218	-	-	2.218	-	-	3.518	4.018	3.318	3.518	4.018	3.318
Pot Cap-1 Maneuver	1372	-	-	1447	-	-	530	525	969	565	535	861
Stage 1	-	-	-	-	-	-	800	719	-	820	749	-
Stage 2	-	-	-	-	-	-	777	736	-	794	717	-
Platoon blocked, %		-	-	1	-	-	1	1	1	1	1	
Mov Cap-1 Maneuver	1372	-	-	1447	-	-	463	506	969	543	516	861
Mov Cap-2 Maneuver	-	-	-	-	-	-	463	506	-	543	516	-
Stage 1	-	-	-	-	-	-	771	693	-	790	749	-
Stage 2	-	-	-	-	-	-	698	736	-	756	691	-

Approach	EB	WB	NB	SB
HCM Control Delay, s	1.8	0	10.9	9.9
HCM LOS			B	A

Minor Lane/Major Mvmt	NBLn1	EBL	EBT	EBR	WBL	WBT	WBR	SBLn1
Capacity (veh/h)	637	1372	-	-	1447	-	-	828
HCM Lane V/C Ratio	0.036	0.036	-	-	-	-	-	0.114
HCM Control Delay (s)	10.9	7.7	-	-	0	-	-	9.9
HCM Lane LOS	B	A	-	-	A	-	-	A
HCM 95th %tile Q(veh)	0.1	0.1	-	-	0	-	-	0.4

Intersection	
Intersection Delay, s/veh	9
Intersection LOS	A

Movement	EBL	EBT	EBR	WBL	WBT	WBR	NBL	NBT	NBR	SBL	SBT	SBR
Lane Configurations	↵	↶		↵	↶		↵	↶		↵	↶	
Traffic Vol, veh/h	74	55	44	29	48	6	61	52	13	5	67	46
Future Vol, veh/h	74	55	44	29	48	6	61	52	13	5	67	46
Peak Hour Factor	0.92	0.92	0.92	0.92	0.92	0.92	0.92	0.92	0.92	0.92	0.92	0.92
Heavy Vehicles, %	2	2	2	2	2	2	2	2	2	2	2	2
Mvmt Flow	80	60	48	32	52	7	66	57	14	5	73	50
Number of Lanes	1	1	0	1	1	0	1	1	0	1	1	0

Approach	EB	WB	NB	SB
Opposing Approach	WB	EB	SB	NB
Opposing Lanes	2	2	2	2
Conflicting Approach Left	SB	NB	EB	WB
Conflicting Lanes Left	2	2	2	2
Conflicting Approach Right	NB	SB	WB	EB
Conflicting Lanes Right	2	2	2	2
HCM Control Delay	9	8.7	9	9
HCM LOS	A	A	A	A

Lane	NBLn1	NBLn2	EBLn1	EBLn2	WBLn1	WBLn2	SBLn1	SBLn2
Vol Left, %	100%	0%	100%	0%	100%	0%	100%	0%
Vol Thru, %	0%	80%	0%	56%	0%	89%	0%	59%
Vol Right, %	0%	20%	0%	44%	0%	11%	0%	41%
Sign Control	Stop	Stop	Stop	Stop	Stop	Stop	Stop	Stop
Traffic Vol by Lane	61	65	74	99	29	54	5	113
LT Vol	61	0	74	0	29	0	5	0
Through Vol	0	52	0	55	0	48	0	67
RT Vol	0	13	0	44	0	6	0	46
Lane Flow Rate	66	71	80	108	32	59	5	123
Geometry Grp	7	7	7	7	7	7	7	7
Degree of Util (X)	0.109	0.103	0.13	0.15	0.052	0.087	0.009	0.175
Departure Headway (Hd)	5.893	5.249	5.825	5.009	5.934	5.352	5.916	5.126
Convergence, Y/N	Yes	Yes	Yes	Yes	Yes	Yes	Yes	Yes
Cap	607	680	614	713	601	666	603	698
Service Time	3.645	3	3.575	2.759	3.692	3.11	3.668	2.878
HCM Lane V/C Ratio	0.109	0.104	0.13	0.151	0.053	0.089	0.008	0.176
HCM Control Delay	9.4	8.6	9.5	8.6	9	8.6	8.7	9
HCM Lane LOS	A	A	A	A	A	A	A	A
HCM 95th-tile Q	0.4	0.3	0.4	0.5	0.2	0.3	0	0.6

15: 73rd Street/Dial Boulevard & Greenway Hayden Loop

08/17/2022

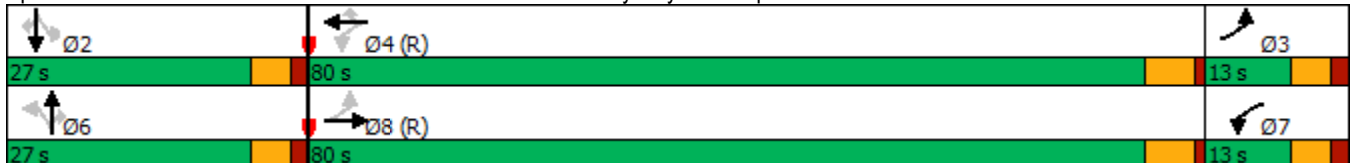


Lane Group	EBL	EBT	WBL	WBT	WBR	NBL	NBT	NBR	SBL	SBT	SBR
Lane Configurations	↘	↑↑↑	↘	↑↑	↗	↘	↑	↗	↘	↑	↗
Traffic Volume (vph)	29	488	189	393	73	35	52	217	78	55	100
Future Volume (vph)	29	488	189	393	73	35	52	217	78	55	100
Turn Type	pm+pt	NA	pm+pt	NA	Perm	Perm	NA	Perm	Perm	NA	Perm
Protected Phases	3	8	7	4			6			2	
Permitted Phases	8		4		4	6		6	2		2
Detector Phase	3	8	7	4	4	6	6	6	2	2	2
Switch Phase											
Minimum Initial (s)	5.0	10.0	5.0	10.0	10.0	7.0	7.0	7.0	7.0	7.0	7.0
Minimum Split (s)	12.0	37.0	37.0	36.0	36.0	37.0	37.0	37.0	37.0	37.0	37.0
Total Split (s)	13.0	80.0	13.0	80.0	80.0	27.0	27.0	27.0	27.0	27.0	27.0
Total Split (%)	10.8%	66.7%	10.8%	66.7%	66.7%	22.5%	22.5%	22.5%	22.5%	22.5%	22.5%
Yellow Time (s)	3.6	4.4	3.6	4.4	4.4	3.6	3.6	3.6	3.6	3.6	3.6
All-Red Time (s)	1.7	1.0	1.7	1.0	1.0	1.6	1.6	1.6	1.6	1.6	1.6
Lost Time Adjust (s)	0.0	0.0	0.0	0.0	0.0	0.0	0.0	0.0	0.0	0.0	0.0
Total Lost Time (s)	5.3	5.4	5.3	5.4	5.4	5.2	5.2	5.2	5.2	5.2	5.2
Lead/Lag	Lag	Lead	Lag	Lead	Lead						
Lead-Lag Optimize?	Yes	Yes	Yes	Yes	Yes						
Recall Mode	Max	C-Min	None	C-Min	C-Min	None	None	None	None	None	None
Act Effct Green (s)	91.1	27.5	93.1	28.5	28.5	12.1	12.1	12.1	12.1	12.1	12.1
Actuated g/C Ratio	0.76	0.23	0.78	0.24	0.24	0.10	0.10	0.10	0.10	0.10	0.10
v/c Ratio	0.03	0.50	0.19	0.51	0.18	0.28	0.30	0.63	0.63	0.32	0.42
Control Delay	3.7	36.6	9.1	28.3	4.6	53.4	52.6	14.2	70.9	53.0	13.8
Queue Delay	0.0	0.0	0.0	0.0	0.0	0.0	0.0	0.0	0.0	0.0	0.0
Total Delay	3.7	36.6	9.1	28.3	4.6	53.4	52.6	14.2	70.9	53.0	13.8
LOS	A	D	A	C	A	D	D	B	E	D	B
Approach Delay		34.9		20.1			25.3			42.2	
Approach LOS		C		C			C			D	

Intersection Summary

Cycle Length: 120
 Actuated Cycle Length: 120
 Offset: 47 (39%), Referenced to phase 4:WBTL and 8:EBTL, Start of Green
 Natural Cycle: 115
 Control Type: Actuated-Coordinated
 Maximum v/c Ratio: 0.63
 Intersection Signal Delay: 28.7
 Intersection Capacity Utilization 45.2%
 Analysis Period (min) 15
 Intersection LOS: C
 ICU Level of Service A

Splits and Phases: 15: 73rd Street/Dial Boulevard & Greenway Hayden Loop



15: 73rd Street/Dial Boulevard & Greenway Hayden Loop

08/17/2022



Movement	EBL	EBT	EBR	WBL	WBT	WBR	NBL	NBT	NBR	SBL	SBT	SBR
Lane Configurations	↖	↕↕↕		↖	↕↕	↖	↖	↕	↖	↖	↕	↖
Traffic Volume (veh/h)	29	488	46	189	393	73	35	52	217	78	55	100
Future Volume (veh/h)	29	488	46	189	393	73	35	52	217	78	55	100
Initial Q (Qb), veh	0	0	0	0	0	0	0	0	0	0	0	0
Ped-Bike Adj(A_pbT)	1.00		1.00	1.00		1.00	1.00		1.00	1.00		1.00
Parking Bus, Adj	1.00	1.00	1.00	1.00	1.00	1.00	1.00	1.00	1.00	1.00	1.00	1.00
Work Zone On Approach		No			No			No			No	
Adj Sat Flow, veh/h/ln	1870	1870	1870	1870	1870	1870	1870	1870	1870	1870	1870	1870
Adj Flow Rate, veh/h	32	530	50	205	427	79	38	57	236	85	60	109
Peak Hour Factor	0.92	0.92	0.92	0.92	0.92	0.92	0.92	0.92	0.92	0.92	0.92	0.92
Percent Heavy Veh, %	2	2	2	2	2	2	2	2	2	2	2	2
Cap, veh/h	1075	714	67	1077	535	239	226	307	261	210	307	261
Arrive On Green	0.18	0.05	0.05	0.55	0.15	0.15	0.16	0.16	0.16	0.16	0.16	0.16
Sat Flow, veh/h	1781	4751	443	1781	3554	1585	1216	1870	1585	1086	1870	1585
Grp Volume(v), veh/h	32	378	202	205	427	79	38	57	236	85	60	109
Grp Sat Flow(s),veh/h/ln	1781	1702	1791	1781	1777	1585	1216	1870	1585	1086	1870	1585
Q Serve(g_s), s	0.0	13.1	13.4	0.0	13.9	5.3	3.3	3.2	17.5	8.8	3.3	7.4
Cycle Q Clear(g_c), s	0.0	13.1	13.4	0.0	13.9	5.3	6.7	3.2	17.5	11.9	3.3	7.4
Prop In Lane	1.00		0.25	1.00		1.00	1.00		1.00	1.00		1.00
Lane Grp Cap(c), veh/h	1075	512	269	1077	535	239	226	307	261	210	307	261
V/C Ratio(X)	0.03	0.74	0.75	0.19	0.80	0.33	0.17	0.19	0.91	0.40	0.20	0.42
Avail Cap(c_a), veh/h	1075	2116	1113	1077	2209	985	247	340	288	229	340	288
HCM Platoon Ratio	0.33	0.33	0.33	1.00	1.00	1.00	1.00	1.00	1.00	1.00	1.00	1.00
Upstream Filter(I)	0.90	0.90	0.90	1.00	1.00	1.00	1.00	1.00	1.00	1.00	1.00	1.00
Uniform Delay (d), s/veh	20.0	54.7	54.8	11.6	49.2	45.6	46.2	43.2	49.2	48.4	43.3	45.0
Incr Delay (d2), s/veh	0.0	8.4	15.9	0.0	11.8	3.7	0.1	0.1	27.1	0.5	0.1	0.4
Initial Q Delay(d3),s/veh	0.0	0.0	0.0	0.0	0.0	0.0	0.0	0.0	0.0	0.0	0.0	0.0
%ile BackOfQ(50%),veh/ln	0.7	6.6	7.6	2.5	7.0	2.4	1.0	1.5	8.9	2.4	1.6	2.9
Unsig. Movement Delay, s/veh												
LnGrp Delay(d),s/veh	20.1	63.1	70.7	11.7	61.0	49.3	46.3	43.3	76.3	48.8	43.4	45.4
LnGrp LOS	C	E	E	B	E	D	D	D	E	D	D	D
Approach Vol, veh/h		612			711			331			254	
Approach Delay, s/veh		63.3			45.5			67.2			46.1	
Approach LOS		E			D			E			D	
Timer - Assigned Phs		2	3	4		6	7	8				
Phs Duration (G+Y+Rc), s		24.9	71.6	23.5		24.9	71.6	23.4				
Change Period (Y+Rc), s		* 5.2	5.3	* 5.4		* 5.2	5.3	* 5.4				
Max Green Setting (Gmax), s		* 22	7.7	* 75		* 22	7.7	* 75				
Max Q Clear Time (g_c+I1), s		13.9	2.0	15.9		19.5	2.0	15.4				
Green Ext Time (p_c), s		0.4	0.0	2.1		0.2	0.1	2.7				

Intersection Summary

HCM 6th Ctrl Delay	55.0
HCM 6th LOS	E

Notes

User approved pedestrian interval to be less than phase max green.
 * HCM 6th computational engine requires equal clearance times for the phases crossing the barrier.

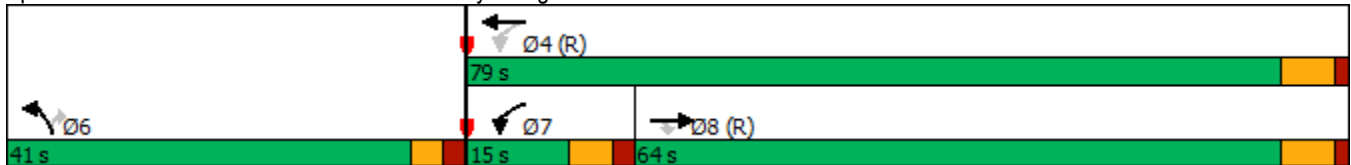


Lane Group	EBT	EBR	WBL	WBT	NBL	NBR
Lane Configurations	↑↑↑	↑	↓	↑↑↑	↓	↓
Traffic Volume (vph)	1365	94	210	827	42	218
Future Volume (vph)	1365	94	210	827	42	218
Turn Type	NA	Perm	pm+pt	NA	Prot	Perm
Protected Phases	8		7	4	6	
Permitted Phases		8	4			6
Detector Phase	8	8	7	4	6	6
Switch Phase						
Minimum Initial (s)	7.0	7.0	5.0	10.0	7.0	7.0
Minimum Split (s)	13.2	13.2	11.0	16.2	12.0	12.0
Total Split (s)	64.0	64.0	15.0	79.0	41.0	41.0
Total Split (%)	53.3%	53.3%	12.5%	65.8%	34.2%	34.2%
Yellow Time (s)	4.7	4.7	4.0	4.7	3.0	3.0
All-Red Time (s)	1.5	1.5	1.9	1.5	2.0	2.0
Lost Time Adjust (s)	0.0	0.0	0.0	0.0	0.0	0.0
Total Lost Time (s)	6.2	6.2	5.9	6.2	5.0	5.0
Lead/Lag	Lag	Lag	Lead			
Lead-Lag Optimize?	Yes	Yes	Yes			
Recall Mode	C-Min	C-Min	None	C-Min	None	None
Act Effct Green (s)	77.8	77.8	97.2	96.9	11.9	11.9
Actuated g/C Ratio	0.65	0.65	0.81	0.81	0.10	0.10
v/c Ratio	0.45	0.10	0.63	0.22	0.14	0.78
Control Delay	6.1	3.4	24.6	0.6	47.6	35.6
Queue Delay	0.0	0.0	0.0	0.0	0.0	0.0
Total Delay	6.1	3.4	24.6	0.6	47.6	35.6
LOS	A	A	C	A	D	D
Approach Delay	6.0			5.5	37.5	
Approach LOS	A			A	D	

Intersection Summary

Cycle Length: 120
 Actuated Cycle Length: 120
 Offset: 75 (63%), Referenced to phase 4:WBTL and 8:EBT, Start of 1st Green
 Natural Cycle: 50
 Control Type: Actuated-Coordinated
 Maximum v/c Ratio: 0.78
 Intersection Signal Delay: 8.8
 Intersection LOS: A
 Intersection Capacity Utilization 58.1%
 ICU Level of Service B
 Analysis Period (min) 15

Splits and Phases: 16: 76th Street & Frank Lloyd Wright Boulevard





Movement	EBT	EBR	WBL	WBT	NBL	NBR	
Lane Configurations	↑↑↑	↑	↓	↑↑↑	↓	↑	
Traffic Volume (veh/h)	1365	94	210	827	42	218	
Future Volume (veh/h)	1365	94	210	827	42	218	
Initial Q (Qb), veh	0	0	0	0	0	0	
Ped-Bike Adj(A_pbT)		1.00	1.00		1.00	1.00	
Parking Bus, Adj	1.00	1.00	1.00	1.00	1.00	1.00	
Work Zone On Approach	No			No	No		
Adj Sat Flow, veh/h/ln	1870	1870	1870	1870	1870	1870	
Adj Flow Rate, veh/h	1484	102	228	899	46	237	
Peak Hour Factor	0.92	0.92	0.92	0.92	0.92	0.92	
Percent Heavy Veh, %	2	2	2	2	2	2	
Cap, veh/h	3201	994	293	3777	577	265	
Arrive On Green	0.21	0.21	0.13	1.00	0.17	0.17	
Sat Flow, veh/h	5274	1585	1781	5274	3456	1585	
Grp Volume(v), veh/h	1484	102	228	899	46	237	
Grp Sat Flow(s),veh/h/ln	1702	1585	1781	1702	1728	1585	
Q Serve(g_s), s	30.6	6.3	5.6	0.0	1.3	17.6	
Cycle Q Clear(g_c), s	30.6	6.3	5.6	0.0	1.3	17.6	
Prop In Lane		1.00	1.00		1.00	1.00	
Lane Grp Cap(c), veh/h	3201	994	293	3777	577	265	
V/C Ratio(X)	0.46	0.10	0.78	0.24	0.08	0.90	
Avail Cap(c_a), veh/h	3201	994	315	3777	1037	476	
HCM Platoon Ratio	0.33	0.33	2.00	2.00	1.00	1.00	
Upstream Filter(I)	0.59	0.59	0.90	0.90	1.00	1.00	
Uniform Delay (d), s/veh	29.9	20.2	17.0	0.0	42.2	49.0	
Incr Delay (d2), s/veh	0.3	0.1	8.7	0.1	0.0	4.3	
Initial Q Delay(d3),s/veh	0.0	0.0	0.0	0.0	0.0	0.0	
%ile BackOfQ(50%),veh/ln	13.9	2.3	4.1	0.0	0.6	14.8	
Unsig. Movement Delay, s/veh							
LnGrp Delay(d),s/veh	30.2	20.4	25.7	0.1	42.2	53.2	
LnGrp LOS	C	C	C	A	D	D	
Approach Vol, veh/h	1586			1127	283		
Approach Delay, s/veh	29.5			5.3	51.4		
Approach LOS	C			A	D		
Timer - Assigned Phs				4	6	7	8
Phs Duration (G+Y+Rc), s				95.0	25.0	13.5	81.4
Change Period (Y+Rc), s				6.2	5.0	* 5.9	6.2
Max Green Setting (Gmax), s				72.8	36.0	* 9.1	57.8
Max Q Clear Time (g_c+I1), s				2.0	19.6	7.6	32.6
Green Ext Time (p_c), s				1.1	0.5	0.0	1.9

Intersection Summary

HCM 6th Ctrl Delay	22.5
HCM 6th LOS	C

Notes

User approved pedestrian interval to be less than phase max green.
 * HCM 6th computational engine requires equal clearance times for the phases crossing the barrier.

Intersection

Intersection Delay, s/veh 10.5

Intersection LOS B

Movement	EBL	EBT	EBR	WBL	WBT	WBR	NBL	NBT	NBR	SBL	SBT	SBR
Lane Configurations												
Traffic Vol, veh/h	140	150	43	18	74	22	3	64	9	28	111	64
Future Vol, veh/h	140	150	43	18	74	22	3	64	9	28	111	64
Peak Hour Factor	0.92	0.92	0.92	0.92	0.92	0.92	0.92	0.92	0.92	0.92	0.92	0.92
Heavy Vehicles, %	2	2	2	2	2	2	2	2	2	2	2	2
Mvmt Flow	152	163	47	20	80	24	3	70	10	30	121	70
Number of Lanes	1	1	0	1	1	0	1	1	0	1	1	0

Approach	EB	WB	NB	SB
Opposing Approach	WB	EB	SB	NB
Opposing Lanes	2	2	2	2
Conflicting Approach Left	SB	NB	EB	WB
Conflicting Lanes Left	2	2	2	2
Conflicting Approach Right	NB	SB	WB	EB
Conflicting Lanes Right	2	2	2	2
HCM Control Delay	10.8	9.6	9.8	10.7
HCM LOS	B	A	A	B

Lane	NBLn1	NBLn2	EBLn1	EBLn2	WBLn1	WBLn2	SBLn1	SBLn2
Vol Left, %	100%	0%	100%	0%	100%	0%	100%	0%
Vol Thru, %	0%	88%	0%	78%	0%	77%	0%	63%
Vol Right, %	0%	12%	0%	22%	0%	23%	0%	37%
Sign Control	Stop	Stop	Stop	Stop	Stop	Stop	Stop	Stop
Traffic Vol by Lane	3	73	140	193	18	96	28	175
LT Vol	3	0	140	0	18	0	28	0
Through Vol	0	64	0	150	0	74	0	111
RT Vol	0	9	0	43	0	22	0	64
Lane Flow Rate	3	79	152	210	20	104	30	190
Geometry Grp	7	7	7	7	7	7	7	7
Degree of Util (X)	0.006	0.135	0.258	0.318	0.035	0.167	0.055	0.302
Departure Headway (Hd)	6.697	6.103	6.105	5.465	6.425	5.757	6.484	5.72
Convergence, Y/N	Yes	Yes	Yes	Yes	Yes	Yes	Yes	Yes
Cap	535	588	590	663	558	624	553	630
Service Time	4.43	3.835	3.826	3.165	4.153	3.484	4.212	3.448
HCM Lane V/C Ratio	0.006	0.134	0.258	0.317	0.036	0.167	0.054	0.302
HCM Control Delay	9.5	9.8	10.9	10.7	9.4	9.6	9.6	10.9
HCM Lane LOS	A	A	B	B	A	A	A	B
HCM 95th-tile Q	0	0.5	1	1.4	0.1	0.6	0.2	1.3

18: Greenway Hayden Loop & Frank Lloyd Wright Boulevard

08/17/2022



Lane Group	EBL	EBT	EBR	WBL	WBT	WBR	NBL	NBT	NBR	SBL	SBT	SBR
Lane Configurations	↔↔	↑↑↑	↔	↔↔	↑↑↑	↔	↔	↑↑	↔	↔↔	↑↑	↔
Traffic Volume (vph)	298	1179	55	572	890	152	12	373	383	213	559	266
Future Volume (vph)	298	1179	55	572	890	152	12	373	383	213	559	266
Turn Type	Prot	NA	Perm	Prot	NA	Perm	Prot	NA	pm+ov	Prot	NA	Perm
Protected Phases	3	8		7	4		1	6	7	5	2	
Permitted Phases			8			4			6			2
Detector Phase	3	8	8	7	4	4	1	6	7	5	2	2
Switch Phase												
Minimum Initial (s)	5.0	10.0	10.0	5.0	10.0	10.0	5.0	7.0	5.0	5.0	7.0	7.0
Minimum Split (s)	11.0	15.9	15.9	11.0	15.9	15.9	11.0	13.0	11.0	11.0	13.0	13.0
Total Split (s)	25.0	36.0	36.0	30.0	41.0	41.0	18.0	24.0	30.0	30.0	36.0	36.0
Total Split (%)	20.8%	30.0%	30.0%	25.0%	34.2%	34.2%	15.0%	20.0%	25.0%	25.0%	30.0%	30.0%
Yellow Time (s)	4.0	4.7	4.7	4.0	4.7	4.7	3.6	4.4	4.0	3.6	4.4	4.4
All-Red Time (s)	2.0	1.0	1.0	2.0	1.0	1.0	2.0	1.2	2.0	2.0	1.2	1.2
Lost Time Adjust (s)	0.0	0.0	0.0	0.0	0.0	0.0	0.0	0.0	0.0	0.0	0.0	0.0
Total Lost Time (s)	6.0	5.7	5.7	6.0	5.7	5.7	5.6	5.6	6.0	5.6	5.6	5.6
Lead/Lag	Lead	Lead	Lead	Lag	Lag	Lag	Lag	Lag	Lag	Lead	Lead	Lead
Lead-Lag Optimize?	Yes	Yes	Yes	Yes	Yes	Yes	Yes	Yes	Yes	Yes	Yes	Yes
Recall Mode	None	C-Min	C-Min	None	C-Min	C-Min	None	None	None	None	None	None
Act Effct Green (s)	14.7	44.3	44.3	23.3	52.8	52.8	6.2	17.1	39.9	12.5	29.8	29.8
Actuated g/C Ratio	0.12	0.37	0.37	0.19	0.44	0.44	0.05	0.14	0.33	0.10	0.25	0.25
v/c Ratio	0.77	0.68	0.09	0.94	0.43	0.21	0.14	0.81	0.68	0.65	0.69	0.47
Control Delay	79.2	23.1	1.0	70.0	25.5	3.7	32.8	37.1	24.8	60.1	45.9	7.0
Queue Delay	0.0	0.0	0.0	0.0	0.0	0.0	0.0	0.0	0.0	0.0	0.0	0.0
Total Delay	79.2	23.1	1.0	70.0	25.5	3.7	32.8	37.1	24.8	60.1	45.9	7.0
LOS	E	C	A	E	C	A	C	D	C	E	D	A
Approach Delay		33.2			39.2			30.9			38.8	
Approach LOS		C			D			C			D	

Intersection Summary

Cycle Length: 120

Actuated Cycle Length: 120

Offset: 93 (78%), Referenced to phase 4:WBT and 8:EBT, Start of 1st Green

Natural Cycle: 80

Control Type: Actuated-Coordinated

Maximum v/c Ratio: 0.94

Intersection Signal Delay: 36.0

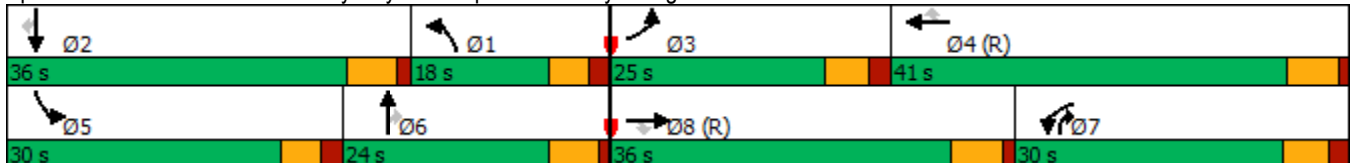
Intersection LOS: D

Intersection Capacity Utilization 77.8%

ICU Level of Service D

Analysis Period (min) 15

Splits and Phases: 18: Greenway Hayden Loop & Frank Lloyd Wright Boulevard



18: Greenway Hayden Loop & Frank Lloyd Wright Boulevard

08/17/2022



Movement	EBL	EBT	EBR	WBL	WBT	WBR	NBL	NBT	NBR	SBL	SBT	SBR
Lane Configurations	↔↔	↑↑↑	↔	↔↔	↑↑↑	↔	↔	↑↑	↔	↔↔	↑↑	↔
Traffic Volume (veh/h)	298	1179	55	572	890	152	12	373	383	213	559	266
Future Volume (veh/h)	298	1179	55	572	890	152	12	373	383	213	559	266
Initial Q (Qb), veh	0	0	0	0	0	0	0	0	0	0	0	0
Ped-Bike Adj(A_pbT)	1.00		1.00	1.00		1.00	1.00		1.00	1.00		1.00
Parking Bus, Adj	1.00	1.00	1.00	1.00	1.00	1.00	1.00	1.00	1.00	1.00	1.00	1.00
Work Zone On Approach		No			No			No			No	
Adj Sat Flow, veh/h/ln	1870	1870	1870	1870	1870	1870	1870	1870	1870	1870	1870	1870
Adj Flow Rate, veh/h	324	1282	60	622	967	165	13	405	416	232	608	289
Peak Hour Factor	0.92	0.92	0.92	0.92	0.92	0.92	0.92	0.92	0.92	0.92	0.92	0.92
Percent Heavy Veh, %	2	2	2	2	2	2	2	2	2	2	2	2
Cap, veh/h	374	1289	400	1171	2455	762	44	471	747	295	687	306
Arrive On Green	0.22	0.50	0.50	0.34	0.48	0.48	0.02	0.13	0.13	0.09	0.19	0.19
Sat Flow, veh/h	3456	5106	1585	3456	5106	1585	1781	3554	1585	3456	3554	1585
Grp Volume(v), veh/h	324	1282	60	622	967	165	13	405	416	232	608	289
Grp Sat Flow(s),veh/h/ln	1728	1702	1585	1728	1702	1585	1781	1777	1585	1728	1777	1585
Q Serve(g_s), s	10.9	30.0	2.4	17.4	14.6	7.2	0.9	13.4	5.6	7.9	20.0	16.1
Cycle Q Clear(g_c), s	10.9	30.0	2.4	17.4	14.6	7.2	0.9	13.4	5.6	7.9	20.0	16.1
Prop In Lane	1.00		1.00	1.00		1.00	1.00		1.00	1.00		1.00
Lane Grp Cap(c), veh/h	374	1289	400	1171	2455	762	44	471	747	295	687	306
V/C Ratio(X)	0.87	0.99	0.15	0.53	0.39	0.22	0.30	0.86	0.56	0.79	0.89	0.94
Avail Cap(c_a), veh/h	547	1289	400	1171	2455	762	184	545	780	703	900	402
HCM Platoon Ratio	2.00	2.00	2.00	1.00	1.00	1.00	1.00	1.00	1.00	1.00	1.00	1.00
Upstream Filter(I)	0.86	0.86	0.86	1.00	1.00	1.00	1.00	1.00	1.00	1.00	1.00	1.00
Uniform Delay (d), s/veh	46.2	29.6	22.8	32.0	20.0	18.1	57.5	51.0	8.7	53.8	47.1	26.6
Incr Delay (d2), s/veh	6.1	21.9	0.7	0.2	0.5	0.7	1.4	10.6	0.4	1.8	7.2	24.3
Initial Q Delay(d3),s/veh	0.0	0.0	0.0	0.0	0.0	0.0	0.0	0.0	0.0	0.0	0.0	0.0
%ile BackOfQ(50%),veh/ln	4.4	10.7	0.9	7.1	5.6	2.7	0.4	6.5	3.7	3.4	9.3	7.9
Unsig. Movement Delay, s/veh												
LnGrp Delay(d),s/veh	52.3	51.6	23.5	32.2	20.4	18.7	58.9	61.6	9.2	55.6	54.3	50.9
LnGrp LOS	D	D	C	C	C	B	E	E	A	E	D	D
Approach Vol, veh/h		1666			1754			834			1129	
Approach Delay, s/veh		50.7			24.5			35.4			53.7	
Approach LOS		D			C			D			D	
Timer - Assigned Phs	1	2	3	4	5	6	7	8				
Phs Duration (G+Y+Rc), s	8.5	28.8	19.0	63.7	15.8	21.5	46.7	36.0				
Change Period (Y+Rc), s	* 5.6	5.6	6.0	* 6	5.6	* 5.6	6.0	5.7				
Max Green Setting (Gmax), s	* 12	30.4	19.0	* 35	24.4	* 18	24.0	30.3				
Max Q Clear Time (g_c+I1), s	2.9	22.0	12.9	16.6	9.9	15.4	19.4	32.0				
Green Ext Time (p_c), s	0.0	1.2	0.1	2.3	0.3	0.5	0.3	0.0				

Intersection Summary

HCM 6th Ctrl Delay	40.4
HCM 6th LOS	D

Notes

- User approved pedestrian interval to be less than phase max green.
- * HCM 6th computational engine requires equal clearance times for the phases crossing the barrier.

19: Greenway Hayden Loop & Paradise Lane

08/17/2022

Intersection												
Int Delay, s/veh	3											
Movement	EBL	EBT	EBR	WBL	WBT	WBR	NBL	NBT	NBR	SBL	SBT	SBR
Lane Configurations		↕	↗		↕	↗	↖	↕	↗	↖	↕	↗
Traffic Vol, veh/h	75	6	14	12	4	24	15	669	31	51	1017	97
Future Vol, veh/h	75	6	14	12	4	24	15	669	31	51	1017	97
Conflicting Peds, #/hr	0	0	0	0	0	0	0	0	0	0	0	0
Sign Control	Stop	Stop	Stop	Stop	Stop	Stop	Free	Free	Free	Free	Free	Free
RT Channelized	-	-	None	-	-	None	-	-	None	-	-	None
Storage Length	-	-	130	-	-	130	150	-	-	110	-	175
Veh in Median Storage, #	-	0	-	-	0	-	-	0	-	-	0	-
Grade, %	-	0	-	-	0	-	-	0	-	-	0	-
Peak Hour Factor	92	92	92	92	92	92	92	92	92	92	92	92
Heavy Vehicles, %	2	2	2	2	2	2	2	2	2	2	2	2
Mvmt Flow	82	7	15	13	4	26	16	727	34	55	1105	105

Major/Minor	Minor2		Minor1		Major1			Major2				
Conflicting Flow All	1613	2008	553	1425	2079	364	1210	0	0	761	0	0
Stage 1	1215	1215	-	759	759	-	-	-	-	-	-	-
Stage 2	398	793	-	666	1320	-	-	-	-	-	-	-
Critical Hdwy	7.54	6.54	6.94	7.54	6.54	6.94	4.14	-	-	4.14	-	-
Critical Hdwy Stg 1	6.54	5.54	-	6.54	5.54	-	-	-	-	-	-	-
Critical Hdwy Stg 2	6.54	5.54	-	6.54	5.54	-	-	-	-	-	-	-
Follow-up Hdwy	3.52	4.02	3.32	3.52	4.02	3.32	2.22	-	-	2.22	-	-
Pot Cap-1 Maneuver	192	88	*659	*320	75	633	940	-	-	847	-	-
Stage 1	570	511	-	*365	413	-	-	-	-	-	-	-
Stage 2	599	398	-	*621	430	-	-	-	-	-	-	-
Platoon blocked, %	1	1	1	1	1	1	1	-	-	-	-	-
Mov Cap-1 Maneuver	165	81	*659	*275	69	633	940	-	-	847	-	-
Mov Cap-2 Maneuver	165	81	-	*275	69	-	-	-	-	-	-	-
Stage 1	561	478	-	*359	406	-	-	-	-	-	-	-
Stage 2	558	391	-	*559	402	-	-	-	-	-	-	-

Approach	EB		WB		NB			SB		
HCM Control Delay, s	49.7		18.9		0.2			0.4		
HCM LOS	E		C							

Minor Lane/Major Mvmt	NBL	NBT	NBR	EBLn1	EBLn2	WBLn1	WBLn2	SBL	SBT	SBR
Capacity (veh/h)	940	-	-	153	659	157	633	847	-	-
HCM Lane V/C Ratio	0.017	-	-	0.575	0.023	0.111	0.041	0.065	-	-
HCM Control Delay (s)	8.9	-	-	56.4	10.6	30.8	10.9	9.5	-	-
HCM Lane LOS	A	-	-	F	B	D	B	A	-	-
HCM 95th %tile Q(veh)	0.1	-	-	3	0.1	0.4	0.1	0.2	-	-

Notes
 ~: Volume exceeds capacity \$: Delay exceeds 300s +: Computation Not Defined *: All major volume in platoon

1: Scottsdale Road & Bell Road/Frank Lloyd Wright Boulevard

08/17/2022



Movement	EBL	EBT	EBR	WBL	WBT	WBR	NBL	NBT	NBR	SBL	SBT	SBR
Lane Configurations	↔↔	↑↑↑	↔	↔↔	↑↑↑	↔	↔↔	↑↑↑	↔	↔↔	↑↑↑	↔
Traffic Volume (veh/h)	297	635	235	156	982	523	352	1366	185	375	1116	291
Future Volume (veh/h)	297	635	235	156	982	523	352	1366	185	375	1116	291
Initial Q (Qb), veh	0	0	0	0	0	0	0	0	0	0	0	0
Ped-Bike Adj(A_pbT)	1.00		1.00	1.00		1.00	1.00		1.00	1.00		1.00
Parking Bus, Adj	1.00	1.00	1.00	1.00	1.00	1.00	1.00	1.00	1.00	1.00	1.00	1.00
Work Zone On Approach		No			No			No			No	
Adj Sat Flow, veh/h/ln	1870	1870	1870	1870	1870	1870	1870	1870	1870	1870	1870	1870
Adj Flow Rate, veh/h	323	690	255	170	1067	568	383	1485	201	408	1213	316
Peak Hour Factor	0.92	0.92	0.92	0.92	0.92	0.92	0.92	0.92	0.92	0.92	0.92	0.92
Percent Heavy Veh, %	2	2	2	2	2	2	2	2	2	2	2	2
Cap, veh/h	317	1369	425	227	1245	650	432	1540	478	574	1377	359
Arrive On Green	0.09	0.27	0.27	0.02	0.08	0.08	0.04	0.10	0.10	0.17	0.34	0.34
Sat Flow, veh/h	3456	5106	1585	3456	5106	1585	3456	5106	1585	3456	4034	1051
Grp Volume(v), veh/h	323	690	255	170	1067	568	383	1485	201	408	1023	506
Grp Sat Flow(s),veh/h/ln	1728	1702	1585	1728	1702	1585	1728	1702	1585	1728	1702	1681
Q Serve(g_s), s	11.0	13.7	16.8	5.9	24.8	22.2	13.2	34.8	10.9	13.4	34.0	34.0
Cycle Q Clear(g_c), s	11.0	13.7	16.8	5.9	24.8	22.2	13.2	34.8	10.9	13.4	34.0	34.0
Prop In Lane	1.00		1.00	1.00		1.00	1.00		1.00	1.00		0.63
Lane Grp Cap(c), veh/h	317	1369	425	227	1245	650	432	1540	478	574	1161	574
V/C Ratio(X)	1.02	0.50	0.60	0.75	0.86	0.87	0.89	0.96	0.42	0.71	0.88	0.88
Avail Cap(c_a), veh/h	317	1413	439	259	1328	676	432	1540	478	574	1161	574
HCM Platoon Ratio	1.00	1.00	1.00	0.33	0.33	0.33	0.33	0.33	0.33	1.00	1.00	1.00
Upstream Filter(I)	1.00	1.00	1.00	0.91	0.91	0.91	0.78	0.78	0.78	1.00	1.00	1.00
Uniform Delay (d), s/veh	54.5	37.2	38.3	57.7	53.1	42.2	56.7	53.4	25.9	47.3	37.2	37.2
Incr Delay (d2), s/veh	55.7	0.1	1.4	7.4	4.7	10.4	15.4	13.4	2.1	3.5	9.7	17.5
Initial Q Delay(d3),s/veh	0.0	0.0	0.0	0.0	0.0	0.0	0.0	0.0	0.0	0.0	0.0	0.0
%ile BackOfQ(50%),veh/ln	7.1	5.6	6.5	2.8	11.8	10.9	7.0	17.7	4.7	5.9	15.0	16.1
Unsig. Movement Delay, s/veh												
LnGrp Delay(d),s/veh	110.2	37.3	39.7	65.2	57.8	52.6	72.1	66.8	28.0	50.8	47.0	54.8
LnGrp LOS	F	D	D	E	E	D	E	E	C	D	D	D
Approach Vol, veh/h		1268			1805			2069			1937	
Approach Delay, s/veh		56.3			56.9			64.0			49.8	
Approach LOS		E			E			E			D	
Timer - Assigned Phs	1	2	3	4	5	6	7	8				
Phs Duration (G+Y+Rc), s	21.0	46.9	17.0	35.1	25.9	42.0	13.9	38.2				
Change Period (Y+Rc), s	6.0	* 6	* 6	5.8	* 6	5.8	6.0	* 6				
Max Green Setting (Gmax), s	15.0	* 39	* 11	31.2	* 18	36.2	9.0	* 33				
Max Q Clear Time (g_c+I1), s	15.2	36.0	13.0	26.8	15.4	36.8	7.9	18.8				
Green Ext Time (p_c), s	0.0	1.5	0.0	2.5	0.2	0.0	0.0	1.5				

Intersection Summary

HCM 6th Ctrl Delay	56.9
HCM 6th LOS	E

Notes

User approved pedestrian interval to be less than phase max green.
 * HCM 6th computational engine requires equal clearance times for the phases crossing the barrier.

2: Scottsdale Road & Paradise Lane

08/17/2022



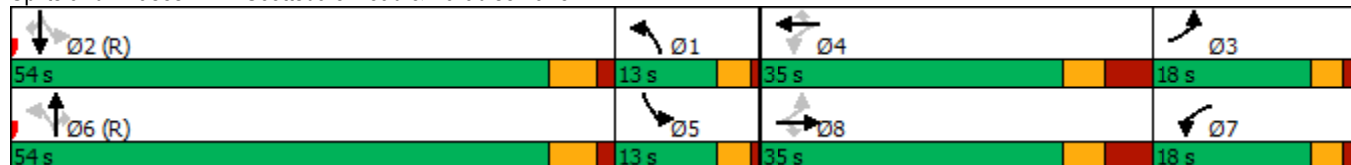
Lane Group	EBL	EBT	EBR	WBL	WBT	WBR	NBL	NBT	NBR	SBL	SBT	SBR
Lane Configurations	↘	↑	↗	↘	↑	↗	↘	↑↑↑	↗	↘	↑↑↑	↗
Traffic Volume (vph)	99	26	17	165	28	250	12	1530	99	130	1292	25
Future Volume (vph)	99	26	17	165	28	250	12	1530	99	130	1292	25
Turn Type	pm+pt	NA	Perm	pm+pt	NA	Perm	pm+pt	NA	Perm	pm+pt	NA	Perm
Protected Phases	3	8		7	4		1	6		5	2	
Permitted Phases	8		8	4		4	6		6	2		2
Detector Phase	3	8	8	7	4	4	1	6	6	5	2	2
Switch Phase												
Minimum Initial (s)	4.0	7.0	7.0	4.0	7.0	7.0	4.0	10.0	10.0	4.0	10.0	10.0
Minimum Split (s)	10.0	15.0	15.0	11.0	15.0	15.0	11.0	16.0	16.0	11.0	16.0	16.0
Total Split (s)	18.0	35.0	35.0	18.0	35.0	35.0	13.0	54.0	54.0	13.0	54.0	54.0
Total Split (%)	15.0%	29.2%	29.2%	15.0%	29.2%	29.2%	10.8%	45.0%	45.0%	10.8%	45.0%	45.0%
Yellow Time (s)	3.0	3.7	3.7	3.0	3.7	3.7	3.0	4.3	4.3	3.0	4.3	4.3
All-Red Time (s)	1.0	4.3	4.3	1.0	4.3	4.3	1.0	1.7	1.7	1.0	1.7	1.7
Lost Time Adjust (s)	0.0	0.0	0.0	0.0	0.0	0.0	0.0	0.0	0.0	0.0	0.0	0.0
Total Lost Time (s)	4.0	8.0	8.0	4.0	8.0	8.0	4.0	6.0	6.0	4.0	6.0	6.0
Lead/Lag	Lag	Lead	Lead	Lag	Lead	Lead	Lag	Lead	Lead	Lag	Lead	Lead
Lead-Lag Optimize?	Yes	Yes	Yes	Yes	Yes	Yes	Yes	Yes	Yes	Yes	Yes	Yes
Recall Mode	None	None	None	None	None	None	None	C-Min	C-Min	None	C-Min	C-Min
Act Effct Green (s)	15.3	7.4	7.4	24.0	8.9	8.9	75.6	68.1	68.1	85.3	79.8	79.8
Actuated g/C Ratio	0.13	0.06	0.06	0.20	0.07	0.07	0.63	0.57	0.57	0.71	0.66	0.66
v/c Ratio	0.50	0.25	0.09	0.55	0.22	0.74	0.05	0.58	0.11	0.50	0.42	0.02
Control Delay	50.5	59.0	1.0	49.4	54.5	18.5	3.8	8.1	0.6	16.8	5.4	0.0
Queue Delay	0.0	0.0	0.0	0.0	0.0	0.0	0.0	0.0	0.0	0.0	0.0	0.0
Total Delay	50.5	59.0	1.0	49.4	54.5	18.5	3.8	8.1	0.6	16.8	5.4	0.0
LOS	D	E	A	D	D	B	A	A	A	B	A	A
Approach Delay		46.3			32.2			7.6			6.3	
Approach LOS		D			C			A			A	

Intersection Summary

Cycle Length: 120
 Actuated Cycle Length: 120
 Offset: 49 (41%), Referenced to phase 2:SBTL and 6:NBTL, Start of 1st Green
 Natural Cycle: 65
 Control Type: Actuated-Coordinated
 Maximum v/c Ratio: 0.74
 Intersection Signal Delay: 11.6
 Intersection Capacity Utilization 67.6%
 Analysis Period (min) 15

Intersection LOS: B
 ICU Level of Service C

Splits and Phases: 2: Scottsdale Road & Paradise Lane



2: Scottsdale Road & Paradise Lane

08/17/2022



Movement	EBL	EBT	EBR	WBL	WBT	WBR	NBL	NBT	NBR	SBL	SBT	SBR
Lane Configurations	↘	↑	↗	↘	↑	↗	↘	↑↑↑	↗	↘	↑↑↑	↗
Traffic Volume (veh/h)	99	26	17	165	28	250	12	1530	99	130	1292	25
Future Volume (veh/h)	99	26	17	165	28	250	12	1530	99	130	1292	25
Initial Q (Qb), veh	0	0	0	0	0	0	0	0	0	0	0	0
Ped-Bike Adj(A_pbT)	1.00		1.00	1.00		1.00	1.00		1.00	1.00		1.00
Parking Bus, Adj	1.00	1.00	1.00	1.00	1.00	1.00	1.00	1.00	1.00	1.00	1.00	1.00
Work Zone On Approach		No			No			No			No	
Adj Sat Flow, veh/h/ln	1870	1870	1870	1870	1870	1870	1870	1870	1870	1870	1870	1870
Adj Flow Rate, veh/h	108	28	18	179	30	272	13	1663	108	141	1404	27
Peak Hour Factor	0.92	0.92	0.92	0.92	0.92	0.92	0.92	0.92	0.92	0.92	0.92	0.92
Percent Heavy Veh, %	2	2	2	2	2	2	2	2	2	2	2	2
Cap, veh/h	166	109	92	385	350	297	595	1722	534	523	1548	481
Arrive On Green	0.03	0.06	0.06	0.16	0.19	0.19	0.59	0.67	0.67	0.09	0.10	0.10
Sat Flow, veh/h	1781	1870	1585	1781	1870	1585	1781	5106	1585	1781	5106	1585
Grp Volume(v), veh/h	108	28	18	179	30	272	13	1663	108	141	1404	27
Grp Sat Flow(s),veh/h/ln	1781	1870	1585	1781	1870	1585	1781	1702	1585	1781	1702	1585
Q Serve(g_s), s	0.0	1.7	1.3	4.0	1.6	20.2	0.0	36.5	3.1	4.8	32.7	1.8
Cycle Q Clear(g_c), s	0.0	1.7	1.3	4.0	1.6	20.2	0.0	36.5	3.1	4.8	32.7	1.8
Prop In Lane	1.00		1.00	1.00		1.00	1.00		1.00	1.00		1.00
Lane Grp Cap(c), veh/h	166	109	92	385	350	297	595	1722	534	523	1548	481
V/C Ratio(X)	0.65	0.26	0.19	0.47	0.09	0.92	0.02	0.97	0.20	0.27	0.91	0.06
Avail Cap(c_a), veh/h	316	421	357	385	421	357	595	2042	634	523	2042	634
HCM Platoon Ratio	1.00	1.00	1.00	1.00	1.00	1.00	2.00	2.00	2.00	0.33	0.33	0.33
Upstream Filter(I)	1.00	1.00	1.00	1.00	1.00	1.00	1.00	1.00	1.00	0.44	0.44	0.44
Uniform Delay (d), s/veh	55.0	54.0	53.8	42.4	40.3	47.8	16.3	18.9	13.5	41.8	52.3	38.5
Incr Delay (d2), s/veh	1.6	0.5	0.4	0.3	0.0	23.1	0.0	15.0	0.9	0.0	4.5	0.1
Initial Q Delay(d3),s/veh	0.0	0.0	0.0	0.0	0.0	0.0	0.0	0.0	0.0	0.0	0.0	0.0
%ile BackOfQ(50%),veh/ln	3.3	0.8	0.5	4.6	0.7	9.9	0.1	8.4	1.2	3.9	15.5	0.7
Unsig. Movement Delay, s/veh												
LnGrp Delay(d),s/veh	56.5	54.5	54.2	42.8	40.3	71.0	16.3	33.9	14.3	41.8	56.8	38.6
LnGrp LOS	E	D	D	D	D	E	B	C	B	D	E	D
Approach Vol, veh/h		154			481			1784			1572	
Approach Delay, s/veh		55.9			58.6			32.6			55.2	
Approach LOS		E			E			C			E	
Timer - Assigned Phs	1	2	3	4	5	6	7	8				
Phs Duration (G+Y+Rc), s	39.3	42.4	7.9	30.5	35.2	46.5	23.4	15.0				
Change Period (Y+Rc), s	* 4	6.0	* 4	8.0	* 4	6.0	* 4	8.0				
Max Green Setting (Gmax), s	* 9	48.0	* 14	27.0	* 9	48.0	* 14	27.0				
Max Q Clear Time (g_c+I1), s	2.0	34.7	2.0	22.2	6.8	38.5	6.0	3.7				
Green Ext Time (p_c), s	0.0	1.7	0.1	0.3	0.0	2.0	0.1	0.1				

Intersection Summary

HCM 6th Ctrl Delay	45.5
HCM 6th LOS	D

Notes

User approved pedestrian interval to be less than phase max green.
 * HCM 6th computational engine requires equal clearance times for the phases crossing the barrier.

3: Scottsdale Road & Driveway A

08/17/2022

Intersection												
Int Delay, s/veh	0.8											
Movement	EBL	EBT	EBR	WBL	WBT	WBR	NBL	NBT	NBR	SBL	SBT	SBR
Lane Configurations			↗			↗	↘	↑↑↑	↗	↘	↑↑↑	↗
Traffic Vol, veh/h	0	0	2	0	0	109	2	1527	128	92	1395	1
Future Vol, veh/h	0	0	2	0	0	109	2	1527	128	92	1395	1
Conflicting Peds, #/hr	0	0	0	0	0	0	0	0	0	0	0	0
Sign Control	Stop	Stop	Stop	Stop	Stop	Stop	Free	Free	Free	Free	Free	Free
RT Channelized	-	-	None	-	-	None	-	-	None	-	-	None
Storage Length	-	-	0	-	-	0	110	-	150	150	-	110
Veh in Median Storage, #	-	0	-	-	0	-	-	0	-	-	0	-
Grade, %	-	0	-	-	0	-	-	0	-	-	0	-
Peak Hour Factor	92	92	92	92	92	92	92	92	92	92	92	92
Heavy Vehicles, %	2	2	2	2	2	2	2	2	2	2	2	2
Mvmt Flow	0	0	2	0	0	118	2	1660	139	100	1516	1

Major/Minor	Minor2		Minor1		Major1			Major2				
Conflicting Flow All	-	-	758	-	-	830	1517	0	0	1799	0	0
Stage 1	-	-	-	-	-	-	-	-	-	-	-	-
Stage 2	-	-	-	-	-	-	-	-	-	-	-	-
Critical Hdwy	-	-	7.14	-	-	7.14	5.34	-	-	5.34	-	-
Critical Hdwy Stg 1	-	-	-	-	-	-	-	-	-	-	-	-
Critical Hdwy Stg 2	-	-	-	-	-	-	-	-	-	-	-	-
Follow-up Hdwy	-	-	3.92	-	-	3.92	3.12	-	-	3.12	-	-
Pot Cap-1 Maneuver	0	0	*588	0	0	*567	*740	-	-	621	-	-
Stage 1	0	0	-	0	0	-	-	-	-	-	-	-
Stage 2	0	0	-	0	0	-	-	-	-	-	-	-
Platoon blocked, %			1			1	1	-	-	1	-	-
Mov Cap-1 Maneuver	-	-	*588	-	-	*567	*740	-	-	621	-	-
Mov Cap-2 Maneuver	-	-	-	-	-	-	-	-	-	-	-	-
Stage 1	-	-	-	-	-	-	-	-	-	-	-	-
Stage 2	-	-	-	-	-	-	-	-	-	-	-	-

Approach	EB		WB		NB			SB		
HCM Control Delay, s	11.1		13		0			0.7		
HCM LOS	B		B							

Minor Lane/Major Mvmt	NBL	NBT	NBR	EBLn1	WBLn1	SBL	SBT	SBR
Capacity (veh/h)	* 740	-	-	588	567	621	-	-
HCM Lane V/C Ratio	0.003	-	-	0.004	0.209	0.161	-	-
HCM Control Delay (s)	9.9	-	-	11.1	13	11.9	-	-
HCM Lane LOS	A	-	-	B	B	B	-	-
HCM 95th %tile Q(veh)	0	-	-	0	0.8	0.6	-	-

Notes
 ~: Volume exceeds capacity \$: Delay exceeds 300s +: Computation Not Defined *: All major volume in platoon

4: Scottsdale Road & Tierra Buena Lane

08/17/2022



Movement	EBL	EBT	EBR	WBL	WBT	WBR	NBL	NBT	NBR	SBL	SBT	SBR
Lane Configurations												
Traffic Volume (veh/h)	10	2	31	100	1	171	30	1487	107	131	1303	12
Future Volume (veh/h)	10	2	31	100	1	171	30	1487	107	131	1303	12
Initial Q (Qb), veh	0	0	0	0	0	0	0	0	0	0	0	0
Ped-Bike Adj(A_pbT)	1.00		1.00	1.00		1.00	1.00		1.00	1.00		1.00
Parking Bus, Adj	1.00	1.00	1.00	1.00	1.00	1.00	1.00	1.00	1.00	1.00	1.00	1.00
Work Zone On Approach		No			No			No			No	
Adj Sat Flow, veh/h/ln	1870	1870	1870	1870	1870	1870	1870	1870	1870	1870	1870	1870
Adj Flow Rate, veh/h	11	2	34	109	1	186	33	1616	116	142	1416	13
Peak Hour Factor	0.92	0.92	0.92	0.92	0.92	0.92	0.92	0.92	0.92	0.92	0.92	0.92
Percent Heavy Veh, %	2	2	2	2	2	2	2	2	2	2	2	2
Cap, veh/h	147	5	88	240	250	212	745	1811	562	627	1487	462
Arrive On Green	0.01	0.06	0.06	0.09	0.13	0.13	0.51	0.47	0.47	0.64	0.58	0.58
Sat Flow, veh/h	1781	89	1510	1781	1870	1585	1781	5106	1585	1781	5106	1585
Grp Volume(v), veh/h	11	0	36	109	1	186	33	1616	116	142	1416	13
Grp Sat Flow(s),veh/h/ln	1781	0	1599	1781	1870	1585	1781	1702	1585	1781	1702	1585
Q Serve(g_s), s	0.0	0.0	2.6	0.9	0.1	13.8	0.0	34.6	5.1	0.0	31.2	0.4
Cycle Q Clear(g_c), s	0.0	0.0	2.6	0.9	0.1	13.8	0.0	34.6	5.1	0.0	31.2	0.4
Prop In Lane	1.00		0.94	1.00		1.00	1.00		1.00	1.00		1.00
Lane Grp Cap(c), veh/h	147	0	93	240	250	212	745	1811	562	627	1487	462
V/C Ratio(X)	0.07	0.00	0.39	0.45	0.00	0.88	0.04	0.89	0.21	0.23	0.95	0.03
Avail Cap(c_a), veh/h	248	0	386	240	452	383	745	2042	634	627	2042	634
HCM Platoon Ratio	1.00	1.00	1.00	1.00	1.00	1.00	1.33	1.33	1.33	2.00	2.00	2.00
Upstream Filter(I)	1.00	0.00	1.00	1.00	1.00	1.00	0.78	0.78	0.78	1.00	1.00	1.00
Uniform Delay (d), s/veh	52.6	0.0	54.4	49.9	45.0	51.0	18.2	29.6	21.8	14.9	24.3	17.8
Incr Delay (d2), s/veh	0.1	0.0	1.0	0.5	0.0	4.5	0.0	5.7	0.6	0.1	14.4	0.1
Initial Q Delay(d3),s/veh	0.0	0.0	0.0	0.0	0.0	0.0	0.0	0.0	0.0	0.0	0.0	0.0
%ile BackOfQ(50%),veh/ln	0.3	0.0	1.1	3.0	0.0	5.7	0.4	12.9	2.0	1.5	9.2	0.2
Unsig. Movement Delay, s/veh												
LnGrp Delay(d),s/veh	52.7	0.0	55.4	50.4	45.0	55.5	18.2	35.4	22.5	15.0	38.6	17.9
LnGrp LOS	D	A	E	D	D	E	B	D	C	B	D	B
Approach Vol, veh/h		47			296			1765			1571	
Approach Delay, s/veh		54.8			53.6			34.2			36.3	
Approach LOS		D			D			C			D	
Timer - Assigned Phs	1	2	3	4	5	6	7	8				
Phs Duration (G+Y+Rc), s	49.7	41.0	5.2	24.1	42.1	48.6	14.3	15.0				
Change Period (Y+Rc), s	* 4	6.0	* 4	8.0	* 4	6.0	* 4	8.0				
Max Green Setting (Gmax), s	* 13	48.0	* 8	29.0	* 13	48.0	* 8	29.0				
Max Q Clear Time (g_c+I1), s	2.0	33.2	2.0	15.8	2.0	36.6	2.9	4.6				
Green Ext Time (p_c), s	0.0	1.8	0.0	0.3	0.1	5.9	0.1	0.1				

Intersection Summary

HCM 6th Ctrl Delay	36.9
HCM 6th LOS	D

Notes

- User approved pedestrian interval to be less than phase max green.
- * HCM 6th computational engine requires equal clearance times for the phases crossing the barrier.

5: Scottsdale Road & Kierland Boulevard/Greenway Hayden Loop

08/17/2022

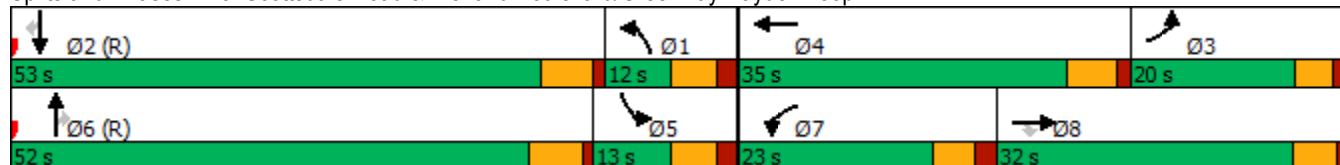


Lane Group	EBL	EBT	EBR	WBL	WBT	NBL	NBT	NBR	SBL	SBT	SBR
Lane Configurations	↔↔	↑↑	↗	↔↔	↑↑↔	↔↔	↑↑↑	↗	↔↔	↑↑↑	↗
Traffic Volume (vph)	184	183	75	391	357	113	1272	270	205	978	237
Future Volume (vph)	184	183	75	391	357	113	1272	270	205	978	237
Turn Type	Prot	NA	Perm	Prot	NA	Prot	NA	Perm	Prot	NA	Perm
Protected Phases	3	8		7	4	1	6		5	2	
Permitted Phases			8					6			2
Detector Phase	3	8	8	7	4	1	6	6	5	2	2
Switch Phase											
Minimum Initial (s)	5.0	7.0	7.0	5.0	7.0	5.0	10.0	10.0	5.0	10.0	10.0
Minimum Split (s)	11.0	13.0	13.0	11.0	13.0	11.0	39.7	39.7	11.0	37.7	37.7
Total Split (s)	20.0	32.0	32.0	23.0	35.0	12.0	52.0	52.0	13.0	53.0	53.0
Total Split (%)	16.7%	26.7%	26.7%	19.2%	29.2%	10.0%	43.3%	43.3%	10.8%	44.2%	44.2%
Yellow Time (s)	3.3	4.0	4.0	3.6	4.4	4.0	4.7	4.7	4.0	4.7	4.7
All-Red Time (s)	2.0	1.6	1.6	2.0	1.3	2.0	1.0	1.0	2.0	1.0	1.0
Lost Time Adjust (s)	0.0	0.0	0.0	0.0	0.0	0.0	0.0	0.0	0.0	0.0	0.0
Total Lost Time (s)	5.3	5.6	5.6	5.6	5.7	6.0	5.7	5.7	6.0	5.7	5.7
Lead/Lag	Lag	Lag	Lag	Lead	Lead	Lag	Lead	Lead	Lag	Lead	Lead
Lead-Lag Optimize?	Yes	Yes	Yes	Yes	Yes	Yes	Yes	Yes	Yes	Yes	Yes
Recall Mode	None	None	None	None	None	None	C-Min	C-Min	None	C-Min	C-Min
Act Effct Green (s)	13.6	11.8	11.8	17.6	16.0	20.4	54.0	54.0	13.7	47.3	47.3
Actuated g/C Ratio	0.11	0.10	0.10	0.15	0.13	0.17	0.45	0.45	0.11	0.39	0.39
v/c Ratio	0.52	0.57	0.30	0.84	0.74	0.21	0.60	0.36	0.57	0.53	0.33
Control Delay	54.9	57.6	4.5	71.5	53.8	29.7	28.9	14.7	68.1	34.8	13.8
Queue Delay	0.0	0.0	0.0	0.0	0.0	0.0	0.0	0.0	0.0	0.0	0.0
Total Delay	54.9	57.6	4.5	71.5	53.8	29.7	28.9	14.7	68.1	34.8	13.8
LOS	D	E	A	E	D	C	C	B	E	C	B
Approach Delay		47.5			61.6		26.7			36.1	
Approach LOS		D			E		C			D	

Intersection Summary

Cycle Length: 120
 Actuated Cycle Length: 120
 Offset: 95 (79%), Referenced to phase 2:SBT and 6:NBT, Start of 1st Green
 Natural Cycle: 80
 Control Type: Actuated-Coordinated
 Maximum v/c Ratio: 0.84
 Intersection Signal Delay: 38.8
 Intersection LOS: D
 Intersection Capacity Utilization 66.5%
 ICU Level of Service C
 Analysis Period (min) 15

Splits and Phases: 5: Scottsdale Road & Kierland Boulevard/Greenway Hayden Loop



5: Scottsdale Road & Kierland Boulevard/Greenway Hayden Loop

08/17/2022



Movement	EBL	EBT	EBR	WBL	WBT	WBR	NBL	NBT	NBR	SBL	SBT	SBR
Lane Configurations	↔↔	↑↑	↗	↔↔	↑↑↔		↔↔	↑↑↑	↗	↔↔	↑↑↑	↗
Traffic Volume (veh/h)	184	183	75	391	357	134	113	1272	270	205	978	237
Future Volume (veh/h)	184	183	75	391	357	134	113	1272	270	205	978	237
Initial Q (Qb), veh	0	0	0	0	0	0	0	0	0	0	0	0
Ped-Bike Adj(A_pbT)	1.00		1.00	1.00		1.00	1.00		1.00	1.00		1.00
Parking Bus, Adj	1.00	1.00	1.00	1.00	1.00	1.00	1.00	1.00	1.00	1.00	1.00	1.00
Work Zone On Approach		No			No			No			No	
Adj Sat Flow, veh/h/ln	1870	1870	1870	1870	1870	1870	1870	1870	1870	1870	1870	1870
Adj Flow Rate, veh/h	200	199	82	425	388	146	123	1383	293	223	1063	258
Peak Hour Factor	0.92	0.92	0.92	0.92	0.92	0.92	0.92	0.92	0.92	0.92	0.92	0.92
Percent Heavy Veh, %	2	2	2	2	2	2	2	2	2	2	2	2
Cap, veh/h	264	278	124	483	522	187	1133	1547	480	997	1345	417
Arrive On Green	0.08	0.08	0.08	0.05	0.05	0.05	0.66	0.61	0.61	0.10	0.09	0.09
Sat Flow, veh/h	3456	3554	1585	3456	3706	1329	3456	5106	1585	3456	5106	1585
Grp Volume(v), veh/h	200	199	82	425	355	179	123	1383	293	223	1063	258
Grp Sat Flow(s),veh/h/ln	1728	1777	1585	1728	1702	1631	1728	1702	1585	1728	1702	1585
Q Serve(g_s), s	6.8	6.6	3.3	14.7	12.4	13.0	1.6	28.0	9.2	7.2	24.5	18.8
Cycle Q Clear(g_c), s	6.8	6.6	3.3	14.7	12.4	13.0	1.6	28.0	9.2	7.2	24.5	18.8
Prop In Lane	1.00		1.00	1.00		0.81	1.00		1.00	1.00		1.00
Lane Grp Cap(c), veh/h	264	278	124	483	479	230	1133	1547	480	997	1345	417
V/C Ratio(X)	0.76	0.72	0.66	0.88	0.74	0.78	0.11	0.89	0.61	0.22	0.79	0.62
Avail Cap(c_a), veh/h	423	782	349	501	831	398	1133	1970	612	997	2013	625
HCM Platoon Ratio	1.00	1.00	1.00	0.33	0.33	0.33	2.00	2.00	2.00	0.33	0.33	0.33
Upstream Filter(I)	1.00	1.00	1.00	0.94	0.94	0.94	0.79	0.79	0.79	0.90	0.90	0.90
Uniform Delay (d), s/veh	54.3	54.0	15.6	56.2	55.0	55.4	14.1	22.0	8.5	41.9	51.5	49.0
Incr Delay (d2), s/veh	1.7	1.3	2.2	14.6	0.8	2.1	0.0	6.8	4.5	0.0	4.3	6.1
Initial Q Delay(d3),s/veh	0.0	0.0	0.0	0.0	0.0	0.0	0.0	0.0	0.0	0.0	0.0	0.0
%ile BackOfQ(50%),veh/ln	3.0	3.0	2.4	7.8	5.7	5.8	0.6	7.0	4.2	3.1	11.7	8.7
Unsig. Movement Delay, s/veh												
LnGrp Delay(d),s/veh	56.0	55.3	17.9	70.9	55.9	57.4	14.2	28.8	13.0	41.9	55.9	55.0
LnGrp LOS	E	E	B	E	E	E	B	C	B	D	E	E
Approach Vol, veh/h		481			959			1799			1544	
Approach Delay, s/veh		49.2			62.8			25.2			53.7	
Approach LOS		D			E			C			D	
Timer - Assigned Phs	1	2	3	4	5	6	7	8				
Phs Duration (G+Y+Rc), s	45.4	37.3	14.8	22.6	40.6	42.1	22.4	15.0				
Change Period (Y+Rc), s	6.0	5.7	* 5.6	* 5.7	6.0	5.7	5.6	* 5.6				
Max Green Setting (Gmax), s	6.0	47.3	* 15	* 29	7.0	46.3	17.4	* 26				
Max Q Clear Time (g_c+I1), s	3.6	26.5	8.8	15.0	9.2	30.0	16.7	8.6				
Green Ext Time (p_c), s	0.0	5.1	0.2	1.8	0.0	6.4	0.1	0.8				

Intersection Summary

HCM 6th Ctrl Delay	44.4
HCM 6th LOS	D

Notes

- User approved pedestrian interval to be less than phase max green.
- * HCM 6th computational engine requires equal clearance times for the phases crossing the barrier.

6: Scottsdale Road & Greenway Parkway/Butherus Drive

08/17/2022

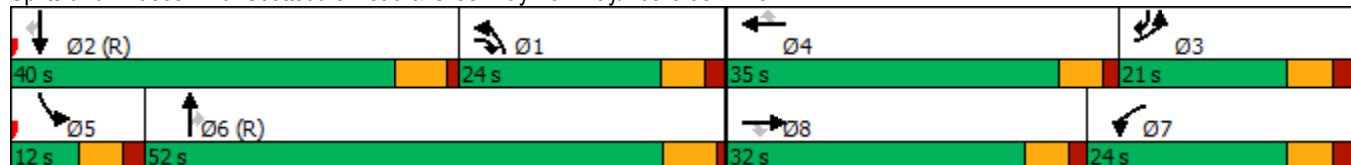


Lane Group	EBL	EBT	EBR	WBL	WBT	WBR	NBL	NBT	NBR	SBL	SBT	SBR
Lane Configurations	↔↔	↕↔	↔	↔↔	↕↕	↔	↔↔	↕↕↕	↔	↔↔	↕↕↕	↔
Traffic Volume (vph)	259	197	180	295	393	211	408	1209	232	98	1119	204
Future Volume (vph)	259	197	180	295	393	211	408	1209	232	98	1119	204
Turn Type	Prot	NA	pm+ov	Prot	NA	Perm	Prot	NA	Perm	Prot	NA	pm+ov
Protected Phases	3	8	1	7	4		1	6		5	2	3
Permitted Phases			8			4			6			2
Detector Phase	3	8	1	7	4	4	1	6	6	5	2	3
Switch Phase												
Minimum Initial (s)	5.0	7.0	5.0	5.0	7.0	7.0	5.0	10.0	10.0	5.0	10.0	5.0
Minimum Split (s)	11.0	13.2	11.0	11.0	13.2	13.2	11.0	16.0	16.0	11.0	16.0	11.0
Total Split (s)	21.0	32.0	24.0	24.0	35.0	35.0	24.0	52.0	52.0	12.0	40.0	21.0
Total Split (%)	17.5%	26.7%	20.0%	20.0%	29.2%	29.2%	20.0%	43.3%	43.3%	10.0%	33.3%	17.5%
Yellow Time (s)	4.0	4.0	4.0	4.0	4.0	4.0	4.0	4.7	4.7	4.0	4.7	4.0
All-Red Time (s)	2.0	1.5	2.0	2.0	1.5	1.5	2.0	1.0	1.0	2.0	1.0	2.0
Lost Time Adjust (s)	0.0	0.0	0.0	0.0	0.0	0.0	0.0	0.0	0.0	0.0	0.0	0.0
Total Lost Time (s)	6.0	5.5	6.0	6.0	5.5	5.5	6.0	5.7	5.7	6.0	5.7	6.0
Lead/Lag	Lag	Lead	Lag	Lag	Lead	Lead	Lag	Lag	Lag	Lead	Lead	Lag
Lead-Lag Optimize?	Yes	Yes	Yes	Yes	Yes	Yes	Yes	Yes	Yes	Yes	Yes	Yes
Recall Mode	None	None	None	None	None	None	None	C-Min	C-Min	None	C-Min	None
Act Effct Green (s)	14.2	13.8	37.4	19.9	19.6	19.6	18.1	55.6	55.6	7.4	45.0	64.8
Actuated g/C Ratio	0.12	0.12	0.31	0.17	0.16	0.16	0.15	0.46	0.46	0.06	0.38	0.54
v/c Ratio	0.70	0.71	0.23	0.56	0.74	0.55	0.86	0.56	0.31	0.50	0.64	0.25
Control Delay	60.0	54.8	5.0	49.5	55.6	15.3	66.3	25.6	11.8	83.3	13.4	2.4
Queue Delay	0.0	0.0	0.0	0.0	0.0	0.0	0.0	0.0	0.0	0.0	0.0	0.0
Total Delay	60.0	54.8	5.0	49.5	55.6	15.3	66.3	25.6	11.8	83.3	13.4	2.4
LOS	E	D	A	D	E	B	E	C	B	F	B	A
Approach Delay		47.9			44.1			32.9			16.7	
Approach LOS		D			D			C			B	

Intersection Summary

Cycle Length: 120
 Actuated Cycle Length: 120
 Offset: 97 (81%), Referenced to phase 2:SBT and 6:NBT, Start of 1st Green
 Natural Cycle: 65
 Control Type: Actuated-Coordinated
 Maximum v/c Ratio: 0.86
 Intersection Signal Delay: 32.2
 Intersection LOS: C
 Intersection Capacity Utilization 70.4%
 ICU Level of Service C
 Analysis Period (min) 15

Splits and Phases: 6: Scottsdale Road & Greenway Parkway/Butherus Drive



6: Scottsdale Road & Greenway Parkway/Butherus Drive

08/17/2022



Movement	EBL	EBT	EBR	WBL	WBT	WBR	NBL	NBT	NBR	SBL	SBT	SBR
Lane Configurations	↔↔	↕↔	↔	↔↔	↕↕	↔	↔↔	↕↕↕	↔	↔↔	↕↕↕	↔
Traffic Volume (veh/h)	259	197	180	295	393	211	408	1209	232	98	1119	204
Future Volume (veh/h)	259	197	180	295	393	211	408	1209	232	98	1119	204
Initial Q (Qb), veh	0	0	0	0	0	0	0	0	0	0	0	0
Ped-Bike Adj(A_pbT)	1.00		1.00	1.00		1.00	1.00		1.00	1.00		1.00
Parking Bus, Adj	1.00	1.00	1.00	1.00	1.00	1.00	1.00	1.00	1.00	1.00	1.00	1.00
Work Zone On Approach		No			No			No			No	
Adj Sat Flow, veh/h/ln	1870	1870	1870	1870	1870	1870	1870	1870	1870	1870	1870	1870
Adj Flow Rate, veh/h	282	303	137	321	427	229	443	1314	0	107	1216	222
Peak Hour Factor	0.92	0.92	0.92	0.92	0.92	0.92	0.92	0.92	0.92	0.92	0.92	0.92
Percent Heavy Veh, %	2	2	2	2	2	2	2	2	2	2	2	2
Cap, veh/h	342	394	640	492	539	241	1031	2609		157	1330	565
Arrive On Green	0.10	0.11	0.11	0.14	0.15	0.15	0.30	0.51	0.00	0.09	0.52	0.52
Sat Flow, veh/h	3563	3741	1585	3456	3554	1585	3456	5106	1585	3456	5106	1585
Grp Volume(v), veh/h	282	303	137	321	427	229	443	1314	0	107	1216	222
Grp Sat Flow(s),veh/h/ln	1781	1870	1585	1728	1777	1585	1728	1702	1585	1728	1702	1585
Q Serve(g_s), s	9.3	9.5	0.0	10.5	13.9	14.3	12.4	20.3	0.0	3.6	26.1	0.0
Cycle Q Clear(g_c), s	9.3	9.5	0.0	10.5	13.9	14.3	12.4	20.3	0.0	3.6	26.1	0.0
Prop In Lane	1.00		1.00	1.00		1.00	1.00		1.00	1.00		1.00
Lane Grp Cap(c), veh/h	342	394	640	492	539	241	1031	2609		157	1330	565
V/C Ratio(X)	0.82	0.77	0.21	0.65	0.79	0.95	0.43	0.50		0.68	0.91	0.39
Avail Cap(c_a), veh/h	445	826	823	518	874	390	1031	2609		173	1459	605
HCM Platoon Ratio	1.00	1.00	1.00	1.00	1.00	1.00	1.00	1.00	1.00	2.00	2.00	2.00
Upstream Filter(I)	1.00	1.00	1.00	1.00	1.00	1.00	1.00	1.00	0.00	0.76	0.76	0.76
Uniform Delay (d), s/veh	53.3	52.3	23.3	48.6	49.1	35.1	33.9	19.3	0.0	53.7	27.5	17.7
Incr Delay (d2), s/veh	7.4	1.2	0.1	2.0	1.0	19.0	0.1	0.7	0.0	5.4	8.9	1.6
Initial Q Delay(d3),s/veh	0.0	0.0	0.0	0.0	0.0	0.0	0.0	0.0	0.0	0.0	0.0	0.0
%ile BackOfQ(50%),veh/ln	4.4	4.4	2.5	4.7	6.2	6.6	5.0	7.7	0.0	1.6	8.0	3.1
Unsig. Movement Delay, s/veh												
LnGrp Delay(d),s/veh	60.6	53.5	23.4	50.7	50.1	54.1	34.0	20.0	0.0	59.1	36.4	19.3
LnGrp LOS	E	D	C	D	D	D	C	C		E	D	B
Approach Vol, veh/h		722			977			1757			1545	
Approach Delay, s/veh		50.6			51.2			23.5			35.5	
Approach LOS		D			D			C			D	
Timer - Assigned Phs	1	2	3	4	5	6	7	8				
Phs Duration (G+Y+Rc), s	41.8	37.0	17.5	23.7	11.4	67.3	23.1	18.1				
Change Period (Y+Rc), s	6.0	5.7	6.0	5.5	6.0	* 6	6.0	5.5				
Max Green Setting (Gmax), s	18.0	34.3	15.0	29.5	6.0	* 46	18.0	26.5				
Max Q Clear Time (g_c+I1), s	14.4	28.1	11.3	16.3	5.6	22.3	12.5	11.5				
Green Ext Time (p_c), s	0.4	3.1	0.2	1.9	0.0	6.3	0.3	1.2				

Intersection Summary

HCM 6th Ctrl Delay	36.6
HCM 6th LOS	D

Notes

- User approved pedestrian interval to be less than phase max green.
- User approved volume balancing among the lanes for turning movement.
- * HCM 6th computational engine requires equal clearance times for the phases crossing the barrier.

Intersection						
Int Delay, s/veh	0.5					
Movement	EBT	EBR	WBL	WBT	NBL	NBR
Lane Configurations	↔			↑		↗
Traffic Vol, veh/h	201	57	0	466	0	38
Future Vol, veh/h	201	57	0	466	0	38
Conflicting Peds, #/hr	0	0	0	0	0	0
Sign Control	Free	Free	Free	Free	Stop	Stop
RT Channelized	-	None	-	None	-	None
Storage Length	-	-	-	-	-	0
Veh in Median Storage, #	0	-	-	0	0	-
Grade, %	0	-	-	0	0	-
Peak Hour Factor	92	92	92	92	92	92
Heavy Vehicles, %	2	2	2	2	2	2
Mvmt Flow	218	62	0	507	0	41
Major/Minor	Major1	Major2	Minor1			
Conflicting Flow All	0	0	-	-	-	249
Stage 1	-	-	-	-	-	-
Stage 2	-	-	-	-	-	-
Critical Hdwy	-	-	-	-	-	6.22
Critical Hdwy Stg 1	-	-	-	-	-	-
Critical Hdwy Stg 2	-	-	-	-	-	-
Follow-up Hdwy	-	-	-	-	-	3.318
Pot Cap-1 Maneuver	-	-	0	-	0	790
Stage 1	-	-	0	-	0	-
Stage 2	-	-	0	-	0	-
Platoon blocked, %	-	-	-	-	-	-
Mov Cap-1 Maneuver	-	-	-	-	-	790
Mov Cap-2 Maneuver	-	-	-	-	-	-
Stage 1	-	-	-	-	-	-
Stage 2	-	-	-	-	-	-
Approach	EB	WB	NB			
HCM Control Delay, s	0	0	9.8			
HCM LOS				A		
Minor Lane/Major Mvmt	NBLn1	EBT	EBR	WBT		
Capacity (veh/h)	790	-	-	-		
HCM Lane V/C Ratio	0.052	-	-	-		
HCM Control Delay (s)	9.8	-	-	-		
HCM Lane LOS	A	-	-	-		
HCM 95th %tile Q(veh)	0.2	-	-	-		

8: Driveway C & Paradise Lane

08/17/2022

Intersection												
Int Delay, s/veh	5											
Movement	EBL	EBT	EBR	WBL	WBT	WBR	NBL	NBT	NBR	SBL	SBT	SBR
Lane Configurations	↶	↷		↶	↷			↕			↕	
Traffic Vol, veh/h	52	155	21	9	259	50	54	0	10	37	0	127
Future Vol, veh/h	52	155	21	9	259	50	54	0	10	37	0	127
Conflicting Peds, #/hr	0	0	0	0	0	0	0	0	0	0	0	0
Sign Control	Free	Free	Free	Free	Free	Free	Stop	Stop	Stop	Stop	Stop	Stop
RT Channelized	-	-	None	-	-	None	-	-	None	-	-	None
Storage Length	100	-	-	100	-	-	-	-	-	-	-	-
Veh in Median Storage, #	-	0	-	-	0	-	-	0	-	-	0	-
Grade, %	-	0	-	-	0	-	-	0	-	-	0	-
Peak Hour Factor	92	92	92	92	92	92	92	92	92	92	92	92
Heavy Vehicles, %	2	2	2	2	2	2	2	2	2	2	2	2
Mvmt Flow	57	168	23	10	282	54	59	0	11	40	0	138

Major/Minor	Major1			Major2			Minor1			Minor2		
Conflicting Flow All	336	0	0	191	0	0	692	650	180	628	634	309
Stage 1	-	-	-	-	-	-	294	294	-	329	329	-
Stage 2	-	-	-	-	-	-	398	356	-	299	305	-
Critical Hdwy	4.12	-	-	4.12	-	-	7.12	6.52	6.22	7.12	6.52	6.22
Critical Hdwy Stg 1	-	-	-	-	-	-	6.12	5.52	-	6.12	5.52	-
Critical Hdwy Stg 2	-	-	-	-	-	-	6.12	5.52	-	6.12	5.52	-
Follow-up Hdwy	2.218	-	-	2.218	-	-	3.518	4.018	3.318	3.518	4.018	3.318
Pot Cap-1 Maneuver	1223	-	-	1407	-	-	371	396	936	413	405	731
Stage 1	-	-	-	-	-	-	758	689	-	684	646	-
Stage 2	-	-	-	-	-	-	628	629	-	753	681	-
Platoon blocked, %		-	-	1	-	-	1	1	1	1	1	
Mov Cap-1 Maneuver	1223	-	-	1407	-	-	288	374	936	391	383	731
Mov Cap-2 Maneuver	-	-	-	-	-	-	288	374	-	391	383	-
Stage 1	-	-	-	-	-	-	723	657	-	652	641	-
Stage 2	-	-	-	-	-	-	506	625	-	709	649	-

Approach	EB			WB			NB			SB		
HCM Control Delay, s	1.8			0.2			19.2			13.3		
HCM LOS							C			B		

Minor Lane/Major Mvmt	NBLn1	EBL	EBT	EBR	WBL	WBT	WBR	SBLn1
Capacity (veh/h)	323	1223	-	-	1407	-	-	611
HCM Lane V/C Ratio	0.215	0.046	-	-	0.007	-	-	0.292
HCM Control Delay (s)	19.2	8.1	-	-	7.6	-	-	13.3
HCM Lane LOS	C	A	-	-	A	-	-	B
HCM 95th %tile Q(veh)	0.8	0.1	-	-	0	-	-	1.2

Intersection						
Int Delay, s/veh	4.7					
Movement	EBT	EBR	WBL	WBT	NBL	NBR
Lane Configurations	↔		↔	↑	↔	↔
Traffic Vol, veh/h	129	109	99	211	107	140
Future Vol, veh/h	129	109	99	211	107	140
Conflicting Peds, #/hr	0	0	0	0	0	0
Sign Control	Free	Free	Free	Free	Stop	Stop
RT Channelized	-	None	-	None	-	None
Storage Length	-	-	100	-	80	0
Veh in Median Storage, #	0	-	-	0	0	-
Grade, %	0	-	-	0	0	-
Peak Hour Factor	92	92	92	92	92	92
Heavy Vehicles, %	2	2	2	2	2	2
Mvmt Flow	140	118	108	229	116	152

Major/Minor	Major1	Major2	Minor1		
Conflicting Flow All	0	0	258	0	644 199
Stage 1	-	-	-	-	199 -
Stage 2	-	-	-	-	445 -
Critical Hdwy	-	-	4.12	-	6.42 6.22
Critical Hdwy Stg 1	-	-	-	-	5.42 -
Critical Hdwy Stg 2	-	-	-	-	5.42 -
Follow-up Hdwy	-	-	2.218	-	3.518 3.318
Pot Cap-1 Maneuver	-	-	1316	-	444 893
Stage 1	-	-	-	-	861 -
Stage 2	-	-	-	-	646 -
Platoon blocked, %	-	-	1	-	1 1
Mov Cap-1 Maneuver	-	-	1316	-	408 893
Mov Cap-2 Maneuver	-	-	-	-	492 -
Stage 1	-	-	-	-	861 -
Stage 2	-	-	-	-	593 -

Approach	EB	WB	NB
HCM Control Delay, s	0	2.5	11.9
HCM LOS			B

Minor Lane/Major Mvmt	NBLn1	NBLn2	EBT	EBR	WBL	WBT
Capacity (veh/h)	492	893	-	-	1316	-
HCM Lane V/C Ratio	0.236	0.17	-	-	0.082	-
HCM Control Delay (s)	14.6	9.9	-	-	8	-
HCM Lane LOS	B	A	-	-	A	-
HCM 95th %tile Q(veh)	0.9	0.6	-	-	0.3	-

Intersection						
Int Delay, s/veh	2.7					
Movement	EBL	EBR	NBL	NBT	SBT	SBR
Lane Configurations						
Traffic Vol, veh/h	71	28	41	185	169	47
Future Vol, veh/h	71	28	41	185	169	47
Conflicting Peds, #/hr	0	0	0	0	0	0
Sign Control	Stop	Stop	Free	Free	Free	Free
RT Channelized	-	None	-	None	-	None
Storage Length	0	-	100	-	-	-
Veh in Median Storage, #	0	-	-	0	0	-
Grade, %	0	-	-	0	0	-
Peak Hour Factor	92	92	92	92	92	92
Heavy Vehicles, %	2	2	2	2	2	2
Mvmt Flow	77	30	45	201	184	51

Major/Minor	Minor2	Major1	Major2			
Conflicting Flow All	501	210	235	0	-	0
Stage 1	210	-	-	-	-	-
Stage 2	291	-	-	-	-	-
Critical Hdwy	6.42	6.22	4.12	-	-	-
Critical Hdwy Stg 1	5.42	-	-	-	-	-
Critical Hdwy Stg 2	5.42	-	-	-	-	-
Follow-up Hdwy	3.518	3.318	2.218	-	-	-
Pot Cap-1 Maneuver	530	830	1332	-	-	-
Stage 1	825	-	-	-	-	-
Stage 2	759	-	-	-	-	-
Platoon blocked, %				-	-	-
Mov Cap-1 Maneuver	512	830	1332	-	-	-
Mov Cap-2 Maneuver	588	-	-	-	-	-
Stage 1	797	-	-	-	-	-
Stage 2	759	-	-	-	-	-

Approach	EB	NB	SB
HCM Control Delay, s	11.7	1.4	0
HCM LOS	B		

Minor Lane/Major Mvmt	NBL	NBT	EBLn1	SBT	SBR
Capacity (veh/h)	1332	-	641	-	-
HCM Lane V/C Ratio	0.033	-	0.168	-	-
HCM Control Delay (s)	7.8	-	11.7	-	-
HCM Lane LOS	A	-	B	-	-
HCM 95th %tile Q(veh)	0.1	-	0.6	-	-

Intersection						
Int Delay, s/veh	1.2					
Movement	WBL	WBR	NBT	NBR	SBL	SBT
Lane Configurations						
Traffic Vol, veh/h	23	23	189	6	1	160
Future Vol, veh/h	23	23	189	6	1	160
Conflicting Peds, #/hr	0	0	0	0	0	0
Sign Control	Stop	Stop	Free	Free	Free	Free
RT Channelized	-	None	-	None	-	None
Storage Length	75	0	-	-	100	-
Veh in Median Storage, #	0	-	0	-	-	0
Grade, %	0	-	0	-	-	0
Peak Hour Factor	92	92	92	92	92	92
Heavy Vehicles, %	2	2	2	2	2	2
Mvmt Flow	25	25	205	7	1	174

Major/Minor	Minor1	Major1	Major2			
Conflicting Flow All	385	209	0	0	212	0
Stage 1	209	-	-	-	-	-
Stage 2	176	-	-	-	-	-
Critical Hdwy	6.42	6.22	-	-	4.12	-
Critical Hdwy Stg 1	5.42	-	-	-	-	-
Critical Hdwy Stg 2	5.42	-	-	-	-	-
Follow-up Hdwy	3.518	3.318	-	-	2.218	-
Pot Cap-1 Maneuver	618	831	-	-	1358	-
Stage 1	826	-	-	-	-	-
Stage 2	855	-	-	-	-	-
Platoon blocked, %			-	-		-
Mov Cap-1 Maneuver	617	831	-	-	1358	-
Mov Cap-2 Maneuver	665	-	-	-	-	-
Stage 1	826	-	-	-	-	-
Stage 2	854	-	-	-	-	-

Approach	WB	NB	SB
HCM Control Delay, s	10.1	0	0
HCM LOS	B		

Minor Lane/Major Mvmt	NBT	NBRWBLn1	WBLn2	SBL	SBT
Capacity (veh/h)	-	-	665	831	1358
HCM Lane V/C Ratio	-	-	0.038	0.03	0.001
HCM Control Delay (s)	-	-	10.6	9.5	7.7
HCM Lane LOS	-	-	B	A	A
HCM 95th %tile Q(veh)	-	-	0.1	0.1	0

Intersection												
Int Delay, s/veh	2.6											
Movement	EBL	EBT	EBR	WBL	WBT	WBR	NBL	NBT	NBR	SBL	SBT	SBR
Lane Configurations		↔			↔		↔	↔		↔	↔	
Traffic Vol, veh/h	42	0	6	0	0	2	64	148	2	2	144	34
Future Vol, veh/h	42	0	6	0	0	2	64	148	2	2	144	34
Conflicting Peds, #/hr	0	0	0	0	0	0	0	0	0	0	0	0
Sign Control	Stop	Stop	Stop	Stop	Stop	Stop	Free	Free	Free	Free	Free	Free
RT Channelized	-	-	None	-	-	None	-	-	None	-	-	None
Storage Length	-	-	-	-	-	-	100	-	-	100	-	-
Veh in Median Storage, #	-	0	-	-	0	-	-	0	-	-	0	-
Grade, %	-	0	-	-	0	-	-	0	-	-	0	-
Peak Hour Factor	92	92	92	92	92	92	92	92	92	92	92	92
Heavy Vehicles, %	2	2	2	2	2	2	2	2	2	2	2	2
Mvmt Flow	46	0	7	0	0	2	70	161	2	2	157	37

Major/Minor	Minor2		Minor1		Major1		Major2					
Conflicting Flow All	483	483	176	485	500	162	194	0	0	163	0	0
Stage 1	180	180	-	302	302	-	-	-	-	-	-	-
Stage 2	303	303	-	183	198	-	-	-	-	-	-	-
Critical Hdwy	7.12	6.52	6.22	7.12	6.52	6.22	4.12	-	-	4.12	-	-
Critical Hdwy Stg 1	6.12	5.52	-	6.12	5.52	-	-	-	-	-	-	-
Critical Hdwy Stg 2	6.12	5.52	-	6.12	5.52	-	-	-	-	-	-	-
Follow-up Hdwy	3.518	4.018	3.318	3.518	4.018	3.318	2.218	-	-	2.218	-	-
Pot Cap-1 Maneuver	494	483	867	492	473	883	1379	-	-	1416	-	-
Stage 1	822	750	-	707	664	-	-	-	-	-	-	-
Stage 2	706	664	-	819	737	-	-	-	-	-	-	-
Platoon blocked, %								-	-	-	-	-
Mov Cap-1 Maneuver	473	458	867	469	448	883	1379	-	-	1416	-	-
Mov Cap-2 Maneuver	473	458	-	469	448	-	-	-	-	-	-	-
Stage 1	780	749	-	671	630	-	-	-	-	-	-	-
Stage 2	669	630	-	812	736	-	-	-	-	-	-	-

Approach	EB		WB		NB		SB	
HCM Control Delay, s	13		9.1		2.3		0.1	
HCM LOS	B		A					

Minor Lane/Major Mvmt	NBL	NBT	NBR	EBLn1WBLn1	SBL	SBT	SBR
Capacity (veh/h)	1379	-	-	501	883	1416	-
HCM Lane V/C Ratio	0.05	-	-	0.104	0.002	0.002	-
HCM Control Delay (s)	7.7	-	-	13	9.1	7.5	-
HCM Lane LOS	A	-	-	B	A	A	-
HCM 95th %tile Q(veh)	0.2	-	-	0.3	0	0	-

Intersection												
Int Delay, s/veh	4											
Movement	EBL	EBT	EBR	WBL	WBT	WBR	NBL	NBT	NBR	SBL	SBT	SBR
Lane Configurations	↶	↷		↶	↷			↕			↕	
Traffic Vol, veh/h	51	189	11	16	158	6	8	0	16	24	0	120
Future Vol, veh/h	51	189	11	16	158	6	8	0	16	24	0	120
Conflicting Peds, #/hr	0	0	0	0	0	0	0	0	0	0	0	0
Sign Control	Free	Free	Free	Free	Free	Free	Stop	Stop	Stop	Stop	Stop	Stop
RT Channelized	-	-	None	-	-	None	-	-	None	-	-	None
Storage Length	100	-	-	100	-	-	-	-	-	-	-	-
Veh in Median Storage, #	-	0	-	-	0	-	-	0	-	-	0	-
Grade, %	-	0	-	-	0	-	-	0	-	-	0	-
Peak Hour Factor	92	92	92	92	92	92	92	92	92	92	92	92
Heavy Vehicles, %	2	2	2	2	2	2	2	2	2	2	2	2
Mvmt Flow	55	205	12	17	172	7	9	0	17	26	0	130

Major/Minor	Major1			Major2			Minor1			Minor2		
Conflicting Flow All	179	0	0	217	0	0	596	534	211	540	537	176
Stage 1	-	-	-	-	-	-	321	321	-	210	210	-
Stage 2	-	-	-	-	-	-	275	213	-	330	327	-
Critical Hdwy	4.12	-	-	4.12	-	-	7.12	6.52	6.22	7.12	6.52	6.22
Critical Hdwy Stg 1	-	-	-	-	-	-	6.12	5.52	-	6.12	5.52	-
Critical Hdwy Stg 2	-	-	-	-	-	-	6.12	5.52	-	6.12	5.52	-
Follow-up Hdwy	2.218	-	-	2.218	-	-	3.518	4.018	3.318	3.518	4.018	3.318
Pot Cap-1 Maneuver	1397	-	-	1382	-	-	443	474	920	489	472	867
Stage 1	-	-	-	-	-	-	744	676	-	792	728	-
Stage 2	-	-	-	-	-	-	731	726	-	736	671	-
Platoon blocked, %		-	-	1	-	-	1	1	1	1	1	
Mov Cap-1 Maneuver	1397	-	-	1382	-	-	362	450	920	461	448	867
Mov Cap-2 Maneuver	-	-	-	-	-	-	362	450	-	461	448	-
Stage 1	-	-	-	-	-	-	715	649	-	761	719	-
Stage 2	-	-	-	-	-	-	613	717	-	693	645	-

Approach	EB			WB			NB			SB		
HCM Control Delay, s	1.6			0.7			11.2			11		
HCM LOS							B			B		

Minor Lane/Major Mvmt	NBLn1	EBL	EBT	EBR	WBL	WBT	WBR	SBLn1
Capacity (veh/h)	608	1397	-	-	1382	-	-	756
HCM Lane V/C Ratio	0.043	0.04	-	-	0.013	-	-	0.207
HCM Control Delay (s)	11.2	7.7	-	-	7.6	-	-	11
HCM Lane LOS	B	A	-	-	A	-	-	B
HCM 95th %tile Q(veh)	0.1	0.1	-	-	0	-	-	0.8

Intersection	
Intersection Delay, s/veh	9.7
Intersection LOS	A

Movement	EBL	EBT	EBR	WBL	WBT	WBR	NBL	NBT	NBR	SBL	SBT	SBR
Lane Configurations	↶	↷		↶	↷		↶	↷		↶	↷	
Traffic Vol, veh/h	117	50	41	38	58	3	56	94	16	8	102	46
Future Vol, veh/h	117	50	41	38	58	3	56	94	16	8	102	46
Peak Hour Factor	0.92	0.92	0.92	0.92	0.92	0.92	0.92	0.92	0.92	0.92	0.92	0.92
Heavy Vehicles, %	2	2	2	2	2	2	2	2	2	2	2	2
Mvmt Flow	127	54	45	41	63	3	61	102	17	9	111	50
Number of Lanes	1	1	0	1	1	0	1	1	0	1	1	0

Approach	EB	WB	NB	SB
Opposing Approach	WB	EB	SB	NB
Opposing Lanes	2	2	2	2
Conflicting Approach Left	SB	NB	EB	WB
Conflicting Lanes Left	2	2	2	2
Conflicting Approach Right	NB	SB	WB	EB
Conflicting Lanes Right	2	2	2	2
HCM Control Delay	9.9	9.3	9.6	9.9
HCM LOS	A	A	A	A

Lane	NBLn1	NBLn2	EBLn1	EBLn2	WBLn1	WBLn2	SBLn1	SBLn2
Vol Left, %	100%	0%	100%	0%	100%	0%	100%	0%
Vol Thru, %	0%	85%	0%	55%	0%	95%	0%	69%
Vol Right, %	0%	15%	0%	45%	0%	5%	0%	31%
Sign Control	Stop	Stop	Stop	Stop	Stop	Stop	Stop	Stop
Traffic Vol by Lane	56	110	117	91	38	61	8	148
LT Vol	56	0	117	0	38	0	8	0
Through Vol	0	94	0	50	0	58	0	102
RT Vol	0	16	0	41	0	3	0	46
Lane Flow Rate	61	120	127	99	41	66	9	161
Geometry Grp	7	7	7	7	7	7	7	7
Degree of Util (X)	0.104	0.183	0.215	0.145	0.073	0.107	0.015	0.243
Departure Headway (Hd)	6.131	5.524	6.089	5.267	6.346	5.806	6.155	5.431
Convergence, Y/N	Yes	Yes	Yes	Yes	Yes	Yes	Yes	Yes
Cap	579	642	584	674	568	621	576	653
Service Time	3.927	3.319	3.882	3.06	4.046	3.506	3.951	3.227
HCM Lane V/C Ratio	0.105	0.187	0.217	0.147	0.072	0.106	0.016	0.247
HCM Control Delay	9.6	9.6	10.6	9	9.5	9.2	9	10
HCM Lane LOS	A	A	B	A	A	A	A	A
HCM 95th-tile Q	0.3	0.7	0.8	0.5	0.2	0.4	0	0.9

15: 73rd Street/Dial Boulevard & Greenway Hayden Loop

08/17/2022



Movement	EBL	EBT	EBR	WBL	WBT	WBR	NBL	NBT	NBR	SBL	SBT	SBR
Lane Configurations	↖	↕↕↕		↖	↕↕	↖	↖	↕	↖	↖	↖	↖
Traffic Volume (veh/h)	87	486	54	183	697	77	94	82	339	50	71	127
Future Volume (veh/h)	87	486	54	183	697	77	94	82	339	50	71	127
Initial Q (Qb), veh	0	0	0	0	0	0	0	0	0	0	0	0
Ped-Bike Adj(A_pbT)	1.00		1.00	1.00		1.00	1.00		1.00	1.00		1.00
Parking Bus, Adj	1.00	1.00	1.00	1.00	1.00	1.00	1.00	1.00	1.00	1.00	1.00	1.00
Work Zone On Approach		No			No			No			No	
Adj Sat Flow, veh/h/ln	1870	1870	1870	1870	1870	1870	1870	1870	1870	1870	1870	1870
Adj Flow Rate, veh/h	95	528	59	199	758	84	102	89	368	54	77	138
Peak Hour Factor	0.92	0.92	0.92	0.92	0.92	0.92	0.92	0.92	0.92	0.92	0.92	0.92
Percent Heavy Veh, %	2	2	2	2	2	2	2	2	2	2	2	2
Cap, veh/h	710	711	78	908	899	401	314	467	396	258	467	396
Arrive On Green	0.12	0.05	0.05	0.47	0.25	0.25	0.25	0.25	0.25	0.25	0.25	0.25
Sat Flow, veh/h	1781	4667	515	1781	3554	1585	1166	1870	1585	934	1870	1585
Grp Volume(v), veh/h	95	383	204	199	758	84	102	89	368	54	77	138
Grp Sat Flow(s),veh/h/ln	1781	1702	1778	1781	1777	1585	1166	1870	1585	934	1870	1585
Q Serve(g_s), s	1.6	13.3	13.6	2.1	24.3	5.0	9.0	4.5	27.2	5.8	3.9	8.6
Cycle Q Clear(g_c), s	1.6	13.3	13.6	2.1	24.3	5.0	12.9	4.5	27.2	10.3	3.9	8.6
Prop In Lane	1.00		0.29	1.00		1.00	1.00		1.00	1.00		1.00
Lane Grp Cap(c), veh/h	710	519	271	908	899	401	314	467	396	258	467	396
V/C Ratio(X)	0.13	0.74	0.75	0.22	0.84	0.21	0.33	0.19	0.93	0.21	0.16	0.35
Avail Cap(c_a), veh/h	710	1719	898	908	1795	800	361	542	460	296	542	460
HCM Platoon Ratio	0.33	0.33	0.33	1.00	1.00	1.00	1.00	1.00	1.00	1.00	1.00	1.00
Upstream Filter(I)	0.87	0.87	0.87	1.00	1.00	1.00	1.00	1.00	1.00	1.00	1.00	1.00
Uniform Delay (d), s/veh	33.7	54.6	54.7	17.2	42.6	35.4	40.3	35.5	44.0	39.5	35.2	37.0
Incr Delay (d2), s/veh	0.0	8.0	15.4	0.0	9.5	1.2	0.2	0.1	22.4	0.1	0.1	0.2
Initial Q Delay(d3),s/veh	0.0	0.0	0.0	0.0	0.0	0.0	0.0	0.0	0.0	0.0	0.0	0.0
%ile BackOfQ(50%),veh/ln	2.4	6.7	7.7	3.0	11.8	2.1	2.6	2.1	13.1	1.4	1.8	3.4
Unsig. Movement Delay, s/veh												
LnGrp Delay(d),s/veh	33.7	62.6	70.2	17.2	52.1	36.6	40.5	35.5	66.4	39.7	35.3	37.2
LnGrp LOS	C	E	E	B	D	D	D	D	E	D	D	D
Approach Vol, veh/h		682			1041			559				269
Approach Delay, s/veh		60.9			44.2			56.8				37.2
Approach LOS		E			D			E				D
Timer - Assigned Phs		2	3	4		6	7	8				
Phs Duration (G+Y+Rc), s		35.2	49.1	35.7		35.2	61.2	23.7				
Change Period (Y+Rc), s		* 5.2	5.3	* 5.4		* 5.2	5.3	* 5.4				
Max Green Setting (Gmax), s		* 35	8.7	* 61		* 35	8.7	* 61				
Max Q Clear Time (g_c+I1), s		12.3	3.6	26.3		29.2	4.1	15.6				
Green Ext Time (p_c), s		0.6	0.0	4.0		0.7	0.1	2.7				

Intersection Summary

HCM 6th Ctrl Delay	50.6
HCM 6th LOS	D

Notes

User approved pedestrian interval to be less than phase max green.

* HCM 6th computational engine requires equal clearance times for the phases crossing the barrier.

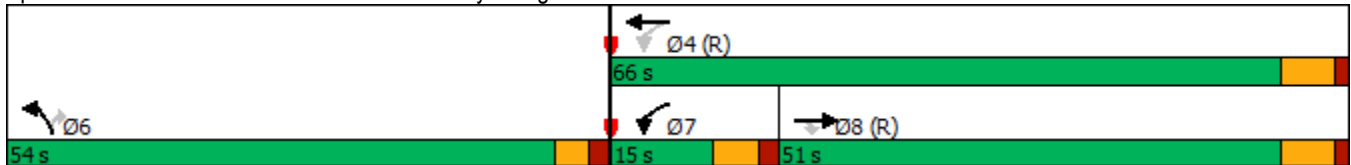


Lane Group	EBT	EBR	WBL	WBT	NBL	NBR
Lane Configurations	↑↑↑	↑	↓	↑↑↑	↓	↑
Traffic Volume (vph)	1134	92	211	1502	144	363
Future Volume (vph)	1134	92	211	1502	144	363
Turn Type	NA	Perm	pm+pt	NA	Prot	Perm
Protected Phases	8		7	4	6	
Permitted Phases		8	4			6
Detector Phase	8	8	7	4	6	6
Switch Phase						
Minimum Initial (s)	7.0	7.0	5.0	10.0	7.0	7.0
Minimum Split (s)	13.2	13.2	11.0	16.2	12.0	12.0
Total Split (s)	51.0	51.0	15.0	66.0	54.0	54.0
Total Split (%)	42.5%	42.5%	12.5%	55.0%	45.0%	45.0%
Yellow Time (s)	4.7	4.7	4.0	4.7	3.0	3.0
All-Red Time (s)	1.5	1.5	1.9	1.5	2.0	2.0
Lost Time Adjust (s)	0.0	0.0	0.0	0.0	0.0	0.0
Total Lost Time (s)	6.2	6.2	5.9	6.2	5.0	5.0
Lead/Lag	Lag	Lag	Lead			
Lead-Lag Optimize?	Yes	Yes	Yes			
Recall Mode	C-Min	C-Min	None	C-Min	None	None
Act Effct Green (s)	65.8	65.8	86.7	86.4	22.4	22.4
Actuated g/C Ratio	0.55	0.55	0.72	0.72	0.19	0.19
v/c Ratio	0.44	0.11	0.58	0.45	0.25	0.87
Control Delay	28.5	15.5	13.2	12.4	40.2	42.8
Queue Delay	0.0	0.0	0.0	0.0	0.0	0.0
Total Delay	28.5	15.5	13.2	12.4	40.2	42.8
LOS	C	B	B	B	D	D
Approach Delay	27.6			12.5	42.0	
Approach LOS	C			B	D	

Intersection Summary

Cycle Length: 120
 Actuated Cycle Length: 120
 Offset: 44 (37%), Referenced to phase 4:WBTL and 8:EBT, Start of 1st Green
 Natural Cycle: 45
 Control Type: Actuated-Coordinated
 Maximum v/c Ratio: 0.87
 Intersection Signal Delay: 22.2
 Intersection Capacity Utilization 53.7%
 Analysis Period (min) 15
 Intersection LOS: C
 ICU Level of Service A

Splits and Phases: 16: 76th Street & Frank Lloyd Wright Boulevard





Movement	EBT	EBR	WBL	WBT	NBL	NBR	
Lane Configurations	↑↑↑	↑	↑	↑↑↑	↑↑	↑	
Traffic Volume (veh/h)	1134	92	211	1502	144	363	
Future Volume (veh/h)	1134	92	211	1502	144	363	
Initial Q (Qb), veh	0	0	0	0	0	0	
Ped-Bike Adj(A_pbT)		1.00	1.00		1.00	1.00	
Parking Bus, Adj	1.00	1.00	1.00	1.00	1.00	1.00	
Work Zone On Approach	No			No	No		
Adj Sat Flow, veh/h/ln	1870	1870	1870	1870	1870	1870	
Adj Flow Rate, veh/h	1233	100	229	1633	157	395	
Peak Hour Factor	0.92	0.92	0.92	0.92	0.92	0.92	
Percent Heavy Veh, %	2	2	2	2	2	2	
Cap, veh/h	2622	814	406	3260	927	425	
Arrive On Green	1.00	1.00	0.15	1.00	0.27	0.27	
Sat Flow, veh/h	5274	1585	1781	5274	3456	1585	
Grp Volume(v), veh/h	1233	100	229	1633	157	395	
Grp Sat Flow(s),veh/h/ln	1702	1585	1781	1702	1728	1585	
Q Serve(g_s), s	0.0	0.0	7.5	0.0	4.2	29.2	
Cycle Q Clear(g_c), s	0.0	0.0	7.5	0.0	4.2	29.2	
Prop In Lane		1.00	1.00		1.00	1.00	
Lane Grp Cap(c), veh/h	2622	814	406	3260	927	425	
V/C Ratio(X)	0.47	0.12	0.56	0.50	0.17	0.93	
Avail Cap(c_a), veh/h	2622	814	406	3260	1411	647	
HCM Platoon Ratio	2.00	2.00	2.00	2.00	1.00	1.00	
Upstream Filter(I)	0.81	0.81	0.69	0.69	1.00	1.00	
Uniform Delay (d), s/veh	0.0	0.0	9.9	0.0	33.7	42.8	
Incr Delay (d2), s/veh	0.5	0.3	0.8	0.4	0.0	11.6	
Initial Q Delay(d3),s/veh	0.0	0.0	0.0	0.0	0.0	0.0	
%ile BackOfQ(50%),veh/ln	0.1	0.1	2.4	0.1	1.8	24.2	
Unsig. Movement Delay, s/veh							
LnGrp Delay(d),s/veh	0.5	0.3	10.7	0.4	33.7	54.4	
LnGrp LOS	A	A	B	A	C	D	
Approach Vol, veh/h	1333			1862	552		
Approach Delay, s/veh	0.5			1.7	48.5		
Approach LOS	A			A	D		
Timer - Assigned Phs				4	6	7	8
Phs Duration (G+Y+Rc), s				82.8	37.2	15.0	67.8
Change Period (Y+Rc), s				6.2	5.0	* 5.9	6.2
Max Green Setting (Gmax), s				59.8	49.0	* 9.1	44.8
Max Q Clear Time (g_c+I1), s				2.0	31.2	9.5	2.0
Green Ext Time (p_c), s				2.2	1.0	0.0	1.5

Intersection Summary

HCM 6th Ctrl Delay	8.1
HCM 6th LOS	A

Notes

User approved pedestrian interval to be less than phase max green.
 * HCM 6th computational engine requires equal clearance times for the phases crossing the barrier.

Intersection

Intersection Delay, s/veh 11.6

Intersection LOS B

Movement	EBL	EBT	EBR	WBL	WBT	WBR	NBL	NBT	NBR	SBL	SBT	SBR
Lane Configurations	↶	↷		↶	↷		↶	↷		↶	↷	
Traffic Vol, veh/h	156	95	11	6	187	55	16	139	16	14	73	48
Future Vol, veh/h	156	95	11	6	187	55	16	139	16	14	73	48
Peak Hour Factor	0.92	0.92	0.92	0.92	0.92	0.92	0.92	0.92	0.92	0.92	0.92	0.92
Heavy Vehicles, %	2	2	2	2	2	2	2	2	2	2	2	2
Mvmt Flow	170	103	12	7	203	60	17	151	17	15	79	52
Number of Lanes	1	1	0	1	1	0	1	1	0	1	1	0

Approach	EB	WB	NB	SB
Opposing Approach	WB	EB	SB	NB
Opposing Lanes	2	2	2	2
Conflicting Approach Left	SB	NB	EB	WB
Conflicting Lanes Left	2	2	2	2
Conflicting Approach Right	NB	SB	WB	EB
Conflicting Lanes Right	2	2	2	2
HCM Control Delay	11.2	12.8	11.5	10.6
HCM LOS	B	B	B	B

Lane	NBLn1	NBLn2	EBLn1	EBLn2	WBLn1	WBLn2	SBLn1	SBLn2
Vol Left, %	100%	0%	100%	0%	100%	0%	100%	0%
Vol Thru, %	0%	90%	0%	90%	0%	77%	0%	60%
Vol Right, %	0%	10%	0%	10%	0%	23%	0%	40%
Sign Control	Stop	Stop	Stop	Stop	Stop	Stop	Stop	Stop
Traffic Vol by Lane	16	155	156	106	6	242	14	121
LT Vol	16	0	156	0	6	0	14	0
Through Vol	0	139	0	95	0	187	0	73
RT Vol	0	16	0	11	0	55	0	48
Lane Flow Rate	17	168	170	115	7	263	15	132
Geometry Grp	7	7	7	7	7	7	7	7
Degree of Util (X)	0.033	0.295	0.305	0.189	0.012	0.427	0.029	0.226
Departure Headway (Hd)	6.884	6.303	6.472	5.892	6.511	5.843	6.966	6.176
Convergence, Y/N	Yes	Yes	Yes	Yes	Yes	Yes	Yes	Yes
Cap	519	569	554	608	549	616	513	580
Service Time	4.635	4.054	4.216	3.636	4.255	3.588	4.721	3.93
HCM Lane V/C Ratio	0.033	0.295	0.307	0.189	0.013	0.427	0.029	0.228
HCM Control Delay	9.9	11.7	12	10	9.3	12.9	9.9	10.7
HCM Lane LOS	A	B	B	A	A	B	A	B
HCM 95th-tile Q	0.1	1.2	1.3	0.7	0	2.1	0.1	0.9

18: Greenway Hayden Loop & Frank Lloyd Wright Boulevard

08/17/2022



Lane Group	EBL	EBT	EBR	WBL	WBT	WBR	NBL	NBT	NBR	SBL	SBT	SBR
Lane Configurations	↔↔	↑↑↑	↔	↔↔	↑↑↑	↔	↔	↑↑	↔	↔↔	↑↑	↔
Traffic Volume (vph)	397	1276	42	502	1287	342	50	566	628	148	464	367
Future Volume (vph)	397	1276	42	502	1287	342	50	566	628	148	464	367
Turn Type	Prot	NA	Perm	Prot	NA	Perm	Prot	NA	pm+ov	Prot	NA	Perm
Protected Phases	3	8		7	4		1	6	7	5	2	
Permitted Phases			8			4			6			2
Detector Phase	3	8	8	7	4	4	1	6	7	5	2	2
Switch Phase												
Minimum Initial (s)	5.0	10.0	10.0	5.0	10.0	10.0	5.0	7.0	5.0	5.0	7.0	7.0
Minimum Split (s)	11.0	15.9	15.9	11.0	15.9	15.9	11.0	13.0	11.0	11.0	13.0	13.0
Total Split (s)	23.0	53.0	53.0	21.0	50.0	50.0	15.0	30.0	21.0	16.0	31.0	31.0
Total Split (%)	19.2%	44.2%	44.2%	17.5%	41.7%	41.7%	12.5%	25.0%	17.5%	13.3%	25.8%	25.8%
Yellow Time (s)	4.0	4.7	4.7	4.0	4.7	4.7	3.6	4.4	4.0	3.6	4.4	4.4
All-Red Time (s)	2.0	1.0	1.0	2.0	1.0	1.0	2.0	1.2	2.0	2.0	1.2	1.2
Lost Time Adjust (s)	0.0	0.0	0.0	0.0	0.0	0.0	0.0	0.0	0.0	0.0	0.0	0.0
Total Lost Time (s)	6.0	5.7	5.7	6.0	5.7	5.7	5.6	5.6	6.0	5.6	5.6	5.6
Lead/Lag	Lead	Lead	Lead	Lag	Lag	Lag	Lag	Lag	Lag	Lead	Lead	Lead
Lead-Lag Optimize?	Yes	Yes	Yes	Yes	Yes	Yes	Yes	Yes	Yes	Yes	Yes	Yes
Recall Mode	None	C-Min	C-Min	None	C-Min	C-Min	None	None	None	None	None	None
Act Effct Green (s)	16.6	40.0	40.0	24.8	48.2	48.2	10.5	23.0	47.4	9.3	23.9	23.9
Actuated g/C Ratio	0.14	0.33	0.33	0.21	0.40	0.40	0.09	0.19	0.40	0.08	0.20	0.20
v/c Ratio	0.91	0.82	0.07	0.77	0.69	0.47	0.35	0.91	0.97	0.61	0.72	0.67
Control Delay	86.1	35.6	1.1	54.3	32.4	10.9	62.5	70.7	53.7	63.4	51.8	13.4
Queue Delay	0.0	0.0	0.0	0.0	0.0	0.0	0.0	0.0	0.0	0.0	0.0	0.0
Total Delay	86.1	35.6	1.1	54.3	32.4	10.9	62.5	70.7	53.7	63.4	51.8	13.4
LOS	F	D	A	D	C	B	E	E	D	E	D	B
Approach Delay		46.4			34.1			61.8			39.1	
Approach LOS		D			C			E			D	

Intersection Summary

Cycle Length: 120

Actuated Cycle Length: 120

Offset: 38 (32%), Referenced to phase 4:WBT and 8:EBT, Start of 1st Green

Natural Cycle: 90

Control Type: Actuated-Coordinated

Maximum v/c Ratio: 0.97

Intersection Signal Delay: 44.1

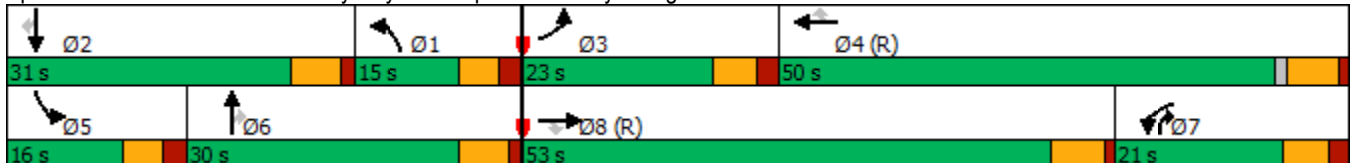
Intersection LOS: D

Intersection Capacity Utilization 82.2%

ICU Level of Service E

Analysis Period (min) 15

Splits and Phases: 18: Greenway Hayden Loop & Frank Lloyd Wright Boulevard



18: Greenway Hayden Loop & Frank Lloyd Wright Boulevard

08/17/2022



Movement	EBL	EBT	EBR	WBL	WBT	WBR	NBL	NBT	NBR	SBL	SBT	SBR
Lane Configurations	↔↔	↑↑↑	↔	↔↔	↑↑↑	↔	↔	↑↑	↔	↔↔	↑↑	↔
Traffic Volume (veh/h)	397	1276	42	502	1287	342	50	566	628	148	464	367
Future Volume (veh/h)	397	1276	42	502	1287	342	50	566	628	148	464	367
Initial Q (Qb), veh	0	0	0	0	0	0	0	0	0	0	0	0
Ped-Bike Adj(A_pbT)	1.00		1.00	1.00		1.00	1.00		1.00	1.00		1.00
Parking Bus, Adj	1.00	1.00	1.00	1.00	1.00	1.00	1.00	1.00	1.00	1.00	1.00	1.00
Work Zone On Approach		No			No			No			No	
Adj Sat Flow, veh/h/ln	1870	1870	1870	1870	1870	1870	1870	1870	1870	1870	1870	1870
Adj Flow Rate, veh/h	432	1387	46	546	1399	372	54	615	683	161	504	399
Peak Hour Factor	0.92	0.92	0.92	0.92	0.92	0.92	0.92	0.92	0.92	0.92	0.92	0.92
Percent Heavy Veh, %	2	2	2	2	2	2	2	2	2	2	2	2
Cap, veh/h	487	1589	493	843	2102	652	162	680	690	217	579	258
Arrive On Green	0.05	0.10	0.10	0.24	0.41	0.41	0.09	0.19	0.19	0.06	0.16	0.16
Sat Flow, veh/h	3456	5106	1585	3456	5106	1585	1781	3554	1585	3456	3554	1585
Grp Volume(v), veh/h	432	1387	46	546	1399	372	54	615	683	161	504	399
Grp Sat Flow(s),veh/h/ln	1728	1702	1585	1728	1702	1585	1781	1777	1585	1728	1777	1585
Q Serve(g_s), s	14.9	32.1	3.2	17.0	26.6	21.7	3.4	20.3	13.3	5.5	16.6	14.0
Cycle Q Clear(g_c), s	14.9	32.1	3.2	17.0	26.6	21.7	3.4	20.3	13.3	5.5	16.6	14.0
Prop In Lane	1.00		1.00	1.00		1.00	1.00		1.00	1.00		1.00
Lane Grp Cap(c), veh/h	487	1589	493	843	2102	652	162	680	690	217	579	258
V/C Ratio(X)	0.89	0.87	0.09	0.65	0.67	0.57	0.33	0.90	0.99	0.74	0.87	1.54
Avail Cap(c_a), veh/h	490	2013	625	843	2102	652	162	723	709	299	752	336
HCM Platoon Ratio	0.33	0.33	0.33	1.00	1.00	1.00	1.00	1.00	1.00	1.00	1.00	1.00
Upstream Filter(I)	0.82	0.82	0.82	1.00	1.00	1.00	1.00	1.00	1.00	1.00	1.00	1.00
Uniform Delay (d), s/veh	56.3	51.5	38.5	40.7	28.6	27.1	51.1	47.5	15.7	55.3	49.0	25.7
Incr Delay (d2), s/veh	14.4	5.8	0.3	1.4	1.7	3.6	0.4	13.8	30.8	3.5	7.3	263.1
Initial Q Delay(d3),s/veh	0.0	0.0	0.0	0.0	0.0	0.0	0.0	0.0	0.0	0.0	0.0	0.0
%ile BackOfQ(50%),veh/ln	7.9	15.4	1.2	7.2	10.7	8.5	1.5	10.1	16.0	2.5	7.8	24.0
Unsig. Movement Delay, s/veh												
LnGrp Delay(d),s/veh	70.7	57.3	38.8	42.1	30.3	30.7	51.6	61.3	46.5	58.7	56.2	288.8
LnGrp LOS	E	E	D	D	C	C	D	E	D	E	E	F
Approach Vol, veh/h		1865			2317			1352			1064	
Approach Delay, s/veh		59.9			33.2			53.4			143.8	
Approach LOS		E			C			D			F	
Timer - Assigned Phs	1	2	3	4	5	6	7	8				
Phs Duration (G+Y+Rc), s	16.5	25.2	22.9	55.4	13.1	28.6	35.3	43.1				
Change Period (Y+Rc), s	* 5.6	5.6	6.0	* 6	5.6	* 5.6	6.0	5.7				
Max Green Setting (Gmax), s	* 9.4	25.4	17.0	* 44	10.4	* 24	15.0	47.3				
Max Q Clear Time (g_c+I1), s	5.4	18.6	16.9	28.6	7.5	22.3	19.0	34.1				
Green Ext Time (p_c), s	0.0	1.0	0.0	3.6	0.1	0.6	0.0	3.2				

Intersection Summary

HCM 6th Ctrl Delay	62.7
HCM 6th LOS	E

Notes

User approved pedestrian interval to be less than phase max green.
 * HCM 6th computational engine requires equal clearance times for the phases crossing the barrier.

Intersection												
Int Delay, s/veh	3.9											
Movement	EBL	EBT	EBR	WBL	WBT	WBR	NBL	NBT	NBR	SBL	SBT	SBR
Lane Configurations		↕	↗		↕	↗	↖	↕	↗	↖	↕	↗
Traffic Vol, veh/h	64	1	21	21	1	63	25	1101	28	29	873	130
Future Vol, veh/h	64	1	21	21	1	63	25	1101	28	29	873	130
Conflicting Peds, #/hr	0	0	0	0	0	0	0	0	0	0	0	0
Sign Control	Stop	Stop	Stop	Stop	Stop	Stop	Free	Free	Free	Free	Free	Free
RT Channelized	-	-	None	-	-	None	-	-	None	-	-	None
Storage Length	-	-	130	-	-	130	150	-	-	110	-	175
Veh in Median Storage, #	-	0	-	-	0	-	-	0	-	-	0	-
Grade, %	-	0	-	-	0	-	-	0	-	-	0	-
Peak Hour Factor	92	92	92	92	92	92	92	92	92	92	92	92
Heavy Vehicles, %	2	2	2	2	2	2	2	2	2	2	2	2
Mvmt Flow	70	1	23	23	1	68	27	1197	30	32	949	141

Major/Minor	Minor2		Minor1		Major1			Major2				
Conflicting Flow All	1666	2294	475	1790	2405	599	1090	0	0	1227	0	0
Stage 1	1013	1013	-	1251	1251	-	-	-	-	-	-	-
Stage 2	653	1281	-	539	1154	-	-	-	-	-	-	-
Critical Hdwy	7.54	6.54	6.94	7.54	6.54	6.94	4.14	-	-	4.14	-	-
Critical Hdwy Stg 1	6.54	5.54	-	6.54	5.54	-	-	-	-	-	-	-
Critical Hdwy Stg 2	6.54	5.54	-	6.54	5.54	-	-	-	-	-	-	-
Follow-up Hdwy	3.52	4.02	3.32	3.52	4.02	3.32	2.22	-	-	2.22	-	-
Pot Cap-1 Maneuver	*137	*43	*711	*100	34	445	987	-	-	564	-	-
Stage 1	*670	*587	-	*183	242	-	-	-	-	-	-	-
Stage 2	*423	*235	-	*670	488	-	-	-	-	-	-	-
Platoon blocked, %	1	1	1	1	1	1	1	-	-	-	-	-
Mov Cap-1 Maneuver	*106	*40	*711	*89	31	445	987	-	-	564	-	-
Mov Cap-2 Maneuver	*106	*40	-	*89	31	-	-	-	-	-	-	-
Stage 1	*652	*554	-	*178	235	-	-	-	-	-	-	-
Stage 2	*347	*229	-	*611	460	-	-	-	-	-	-	-

Approach	EB	WB	NB	SB
HCM Control Delay, s	74.2	27.9	0.2	0.3
HCM LOS	F	D		

Minor Lane/Major Mvmt	NBL	NBT	NBR	EBLn1	EBLn2	WBLn1	WBLn2	SBL	SBT	SBR
Capacity (veh/h)	987	-	-	103	711	82	445	564	-	-
HCM Lane V/C Ratio	0.028	-	-	0.686	0.032	0.292	0.154	0.056	-	-
HCM Control Delay (s)	8.8	-	-	94.9	10.2	66.1	14.6	11.8	-	-
HCM Lane LOS	A	-	-	F	B	F	B	B	-	-
HCM 95th %tile Q(veh)	0.1	-	-	3.5	0.1	1.1	0.5	0.2	-	-

Notes
 ~: Volume exceeds capacity \$: Delay exceeds 300s +: Computation Not Defined *: All major volume in platoon



Appendix K – Year 2030 No Build Capacity Analysis

1: Scottsdale Road & Bell Road/Frank Lloyd Wright Boulevard

08/18/2022



Movement	EBL	EBT	EBR	WBL	WBT	WBR	NBL	NBT	NBR	SBL	SBT	SBR
Lane Configurations	↔↔	↑↑↑	↔	↔↔	↑↑↑	↔	↔↔	↑↑↑	↔	↔↔	↑↑↑	↔
Traffic Volume (veh/h)	421	1215	329	182	484	222	135	686	115	399	1545	185
Future Volume (veh/h)	421	1215	329	182	484	222	135	686	115	399	1545	185
Initial Q (Qb), veh	0	0	0	0	0	0	0	0	0	0	0	0
Ped-Bike Adj(A_pbT)	1.00		1.00	1.00		1.00	1.00		1.00	1.00		1.00
Parking Bus, Adj	1.00	1.00	1.00	1.00	1.00	1.00	1.00	1.00	1.00	1.00	1.00	1.00
Work Zone On Approach		No			No			No			No	
Adj Sat Flow, veh/h/ln	1870	1870	1870	1870	1870	1870	1870	1870	1870	1870	1870	1870
Adj Flow Rate, veh/h	458	1321	358	198	526	241	147	746	125	434	1679	201
Peak Hour Factor	0.92	0.92	0.92	0.92	0.92	0.92	0.92	0.92	0.92	0.92	0.92	0.92
Percent Heavy Veh, %	2	2	2	2	2	2	2	2	2	2	2	2
Cap, veh/h	760	1415	439	230	641	654	203	873	271	991	1837	219
Arrive On Green	0.22	0.28	0.28	0.13	0.25	0.25	0.02	0.06	0.06	0.29	0.40	0.40
Sat Flow, veh/h	3456	5106	1585	3456	5106	1585	3456	5106	1585	3456	4623	552
Grp Volume(v), veh/h	458	1321	358	198	526	241	147	746	125	434	1235	645
Grp Sat Flow(s),veh/h/ln	1728	1702	1585	1728	1702	1585	1728	1702	1585	1728	1702	1771
Q Serve(g_s), s	14.3	30.3	25.3	6.7	11.7	0.0	5.1	17.4	7.3	12.3	41.2	41.4
Cycle Q Clear(g_c), s	14.3	30.3	25.3	6.7	11.7	0.0	5.1	17.4	7.3	12.3	41.2	41.4
Prop In Lane	1.00		1.00	1.00		1.00	1.00		1.00	1.00		0.31
Lane Grp Cap(c), veh/h	760	1415	439	230	641	654	203	873	271	991	1353	704
V/C Ratio(X)	0.60	0.93	0.82	0.86	0.82	0.37	0.72	0.85	0.46	0.44	0.91	0.92
Avail Cap(c_a), veh/h	760	1455	452	230	817	708	259	1072	333	991	1353	704
HCM Platoon Ratio	1.00	1.00	1.00	2.00	2.00	2.00	0.33	0.33	0.33	1.00	1.00	1.00
Upstream Filter(I)	1.00	1.00	1.00	0.98	0.98	0.98	0.77	0.77	0.77	1.00	1.00	1.00
Uniform Delay (d), s/veh	42.1	42.3	40.5	51.4	43.7	20.4	57.9	55.1	32.9	34.9	34.2	34.3
Incr Delay (d2), s/veh	1.0	10.9	10.0	24.9	4.1	0.1	3.5	8.3	4.3	0.1	10.9	18.8
Initial Q Delay(d3),s/veh	0.0	0.0	0.0	0.0	0.0	0.0	0.0	0.0	0.0	0.0	0.0	0.0
%ile BackOfQ(50%),veh/ln	6.0	13.6	10.7	3.5	4.5	3.8	2.3	8.6	3.2	5.0	18.1	20.4
Unsig. Movement Delay, s/veh												
LnGrp Delay(d),s/veh	43.1	53.2	50.5	76.4	47.8	20.5	61.4	63.4	37.2	35.0	45.1	53.0
LnGrp LOS	D	D	D	E	D	C	E	E	D	D	D	D
Approach Vol, veh/h		2137			965			1018			2314	
Approach Delay, s/veh		50.6			46.8			59.9			45.4	
Approach LOS		D			D			E			D	
Timer - Assigned Phs	1	2	3	4	5	6	7	8				
Phs Duration (G+Y+Rc), s	13.1	53.7	32.4	20.9	40.4	26.3	14.0	39.2				
Change Period (Y+Rc), s	6.0	* 6	* 6	5.8	* 6	5.8	6.0	* 6				
Max Green Setting (Gmax), s	9.0	* 45	* 23	19.2	* 29	25.2	8.0	* 34				
Max Q Clear Time (g_c+I1), s	7.1	43.4	16.3	13.7	14.3	19.4	8.7	32.3				
Green Ext Time (p_c), s	0.0	1.1	0.5	1.4	0.7	1.1	0.0	1.0				

Intersection Summary

HCM 6th Ctrl Delay	49.6
HCM 6th LOS	D

Notes

- User approved pedestrian interval to be less than phase max green.
- * HCM 6th computational engine requires equal clearance times for the phases crossing the barrier.

2: Scottsdale Road & Paradise Lane

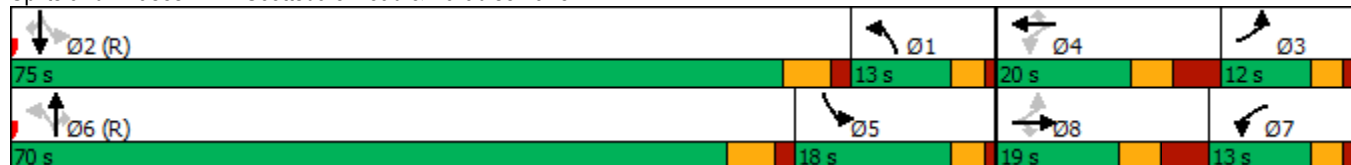
08/18/2022

Lane Group	EBL	EBT	EBR	WBL	WBT	WBR	NBL	NBT	NBR	SBL	SBT	SBR
Lane Configurations												
Traffic Volume (vph)	46	15	7	55	23	68	32	819	60	159	1570	54
Future Volume (vph)	46	15	7	55	23	68	32	819	60	159	1570	54
Turn Type	pm+pt	NA	Perm	pm+pt	NA	Perm	pm+pt	NA	Perm	pm+pt	NA	Perm
Protected Phases	3	8		7	4		1	6		5	2	
Permitted Phases	8		8	4		4	6		6	2		2
Detector Phase	3	8	8	7	4	4	1	6	6	5	2	2
Switch Phase												
Minimum Initial (s)	4.0	7.0	7.0	4.0	7.0	7.0	4.0	10.0	10.0	4.0	10.0	10.0
Minimum Split (s)	10.0	15.0	15.0	11.0	15.0	15.0	11.0	16.0	16.0	11.0	16.0	16.0
Total Split (s)	12.0	19.0	19.0	13.0	20.0	20.0	13.0	70.0	70.0	18.0	75.0	75.0
Total Split (%)	10.0%	15.8%	15.8%	10.8%	16.7%	16.7%	10.8%	58.3%	58.3%	15.0%	62.5%	62.5%
Yellow Time (s)	3.0	3.7	3.7	3.0	3.7	3.7	3.0	4.3	4.3	3.0	4.3	4.3
All-Red Time (s)	1.0	4.3	4.3	1.0	4.3	4.3	1.0	1.7	1.7	1.0	1.7	1.7
Lost Time Adjust (s)	0.0	0.0	0.0	0.0	0.0	0.0	0.0	0.0	0.0	0.0	0.0	0.0
Total Lost Time (s)	4.0	8.0	8.0	4.0	8.0	8.0	4.0	6.0	6.0	4.0	6.0	6.0
Lead/Lag	Lag	Lead	Lead	Lag	Lead	Lead	Lag	Lead	Lead	Lag	Lead	Lead
Lead-Lag Optimize?	Yes	Yes	Yes	Yes	Yes	Yes	Yes	Yes	Yes	Yes	Yes	Yes
Recall Mode	None	None	None	Min	None	None	Max	C-Min	C-Min	None	C-Min	C-Min
Act Effct Green (s)	11.6	7.0	7.0	16.4	7.3	7.3	67.9	32.9	32.9	93.4	54.4	54.4
Actuated g/C Ratio	0.10	0.06	0.06	0.14	0.06	0.06	0.57	0.27	0.27	0.78	0.45	0.45
v/c Ratio	0.29	0.15	0.04	0.27	0.22	0.39	0.06	0.64	0.13	0.19	0.74	0.08
Control Delay	49.0	56.9	0.4	47.1	58.5	10.9	9.6	42.4	13.8	19.4	18.1	1.2
Queue Delay	0.0	0.0	0.0	0.0	0.0	0.0	0.0	0.0	0.0	0.0	0.0	0.0
Total Delay	49.0	56.9	0.4	47.1	58.5	10.9	9.6	42.4	13.8	19.4	18.1	1.2
LOS	D	E	A	D	E	B	A	D	B	B	B	A
Approach Delay		45.5			32.0			39.3			17.7	
Approach LOS		D			C			D			B	

Intersection Summary

Cycle Length: 120
 Actuated Cycle Length: 120
 Offset: 20 (17%), Referenced to phase 2:SBTL and 6:NBT, Start of 1st Green
 Natural Cycle: 65
 Control Type: Actuated-Coordinated
 Maximum v/c Ratio: 0.74
 Intersection Signal Delay: 25.9
 Intersection Capacity Utilization 58.4%
 Analysis Period (min) 15
 Intersection LOS: C
 ICU Level of Service B

Splits and Phases: 2: Scottsdale Road & Paradise Lane



2: Scottsdale Road & Paradise Lane

08/18/2022



Movement	EBL	EBT	EBR	WBL	WBT	WBR	NBL	NBT	NBR	SBL	SBT	SBR
Lane Configurations	↘	↑	↗	↘	↑	↗	↘	↑↑↑	↗	↘	↑↑↑	↗
Traffic Volume (veh/h)	46	15	7	55	23	68	32	819	60	159	1570	54
Future Volume (veh/h)	46	15	7	55	23	68	32	819	60	159	1570	54
Initial Q (Qb), veh	0	0	0	0	0	0	0	0	0	0	0	0
Ped-Bike Adj(A_pbT)	1.00		1.00	1.00		1.00	1.00		1.00	1.00		1.00
Parking Bus, Adj	1.00	1.00	1.00	1.00	1.00	1.00	1.00	1.00	1.00	1.00	1.00	1.00
Work Zone On Approach		No			No			No			No	
Adj Sat Flow, veh/h/ln	1870	1870	1870	1870	1870	1870	1870	1870	1870	1870	1870	1870
Adj Flow Rate, veh/h	50	16	8	60	25	74	35	890	65	173	1707	59
Peak Hour Factor	0.92	0.92	0.92	0.92	0.92	0.92	0.92	0.92	0.92	0.92	0.92	0.92
Percent Heavy Veh, %	2	2	2	2	2	2	2	2	2	2	2	2
Cap, veh/h	170	109	92	189	118	100	699	1012	314	1004	1870	581
Arrive On Green	0.03	0.06	0.06	0.03	0.06	0.06	0.12	0.07	0.07	0.17	0.12	0.12
Sat Flow, veh/h	1781	1870	1585	1781	1870	1585	1781	5106	1585	1781	5106	1585
Grp Volume(v), veh/h	50	16	8	60	25	74	35	890	65	173	1707	59
Grp Sat Flow(s),veh/h/ln	1781	1870	1585	1781	1870	1585	1781	1702	1585	1781	1702	1585
Q Serve(g_s), s	0.0	1.0	0.6	0.0	1.5	5.5	0.0	20.7	4.7	5.4	39.6	4.0
Cycle Q Clear(g_c), s	0.0	1.0	0.6	0.0	1.5	5.5	0.0	20.7	4.7	5.4	39.6	4.0
Prop In Lane	1.00		1.00	1.00		1.00	1.00		1.00	1.00		1.00
Lane Grp Cap(c), veh/h	170	109	92	189	118	100	699	1012	314	1004	1870	581
V/C Ratio(X)	0.29	0.15	0.09	0.32	0.21	0.74	0.05	0.88	0.21	0.17	0.91	0.10
Avail Cap(c_a), veh/h	238	171	145	263	187	159	699	2723	845	1004	2936	911
HCM Platoon Ratio	1.00	1.00	1.00	1.00	1.00	1.00	0.33	0.33	0.33	0.33	0.33	0.33
Upstream Filter(I)	1.00	1.00	1.00	1.00	1.00	1.00	1.00	1.00	1.00	0.31	0.31	0.31
Uniform Delay (d), s/veh	53.5	53.7	53.5	52.7	53.4	55.3	33.9	54.7	47.1	24.6	50.8	35.2
Incr Delay (d2), s/veh	0.4	0.2	0.1	0.4	0.3	4.0	0.1	10.8	1.5	0.0	2.9	0.1
Initial Q Delay(d3),s/veh	0.0	0.0	0.0	0.0	0.0	0.0	0.0	0.0	0.0	0.0	0.0	0.0
%ile BackOfQ(50%),veh/ln	1.5	0.5	0.2	1.7	0.7	2.3	0.9	10.5	2.0	4.0	18.5	1.6
Unsig. Movement Delay, s/veh												
LnGrp Delay(d),s/veh	53.9	53.9	53.6	53.0	53.7	59.3	34.0	65.5	48.6	24.7	53.8	35.3
LnGrp LOS	D	D	D	D	D	E	C	E	D	C	D	D
Approach Vol, veh/h		74			159			990			1939	
Approach Delay, s/veh		53.8			56.1			63.3			50.6	
Approach LOS		D			E			E			D	
Timer - Assigned Phs	1	2	3	4	5	6	7	8				
Phs Duration (G+Y+Rc), s	47.1	50.0	7.4	15.5	67.2	29.8	8.0	15.0				
Change Period (Y+Rc), s	* 4	6.0	* 4	8.0	* 4	6.0	* 4	8.0				
Max Green Setting (Gmax), s	* 9	69.0	* 8	12.0	* 14	64.0	* 9	11.0				
Max Q Clear Time (g_c+I1), s	2.0	41.6	2.0	7.5	7.4	22.7	2.0	3.0				
Green Ext Time (p_c), s	0.0	2.3	0.0	0.1	0.1	1.0	0.0	0.0				

Intersection Summary

HCM 6th Ctrl Delay	54.9
HCM 6th LOS	D

Notes

User approved pedestrian interval to be less than phase max green.
 * HCM 6th computational engine requires equal clearance times for the phases crossing the barrier.

3: Scottsdale Road & Driveway A

08/18/2022

Intersection						
Int Delay, s/veh	0					
Movement	EBL	EBR	NBL	NBT	SBT	SBR
Lane Configurations		↗	↘	↑↑↑	↑↑↑	↗
Traffic Vol, veh/h	0	2	7	909	1634	4
Future Vol, veh/h	0	2	7	909	1634	4
Conflicting Peds, #/hr	0	0	0	0	0	0
Sign Control	Stop	Stop	Free	Free	Free	Free
RT Channelized	-	None	-	None	-	None
Storage Length	-	0	110	-	-	110
Veh in Median Storage, #	0	-	-	0	0	-
Grade, %	0	-	-	0	0	-
Peak Hour Factor	92	92	92	92	92	92
Heavy Vehicles, %	2	2	2	2	2	2
Mvmt Flow	0	2	8	988	1776	4

Major/Minor	Minor2	Major1	Major2		
Conflicting Flow All	-	888	1780	0	-
Stage 1	-	-	-	-	-
Stage 2	-	-	-	-	-
Critical Hdwy	-	7.14	5.34	-	-
Critical Hdwy Stg 1	-	-	-	-	-
Critical Hdwy Stg 2	-	-	-	-	-
Follow-up Hdwy	-	3.92	3.12	-	-
Pot Cap-1 Maneuver	0	*545	*686	-	-
Stage 1	0	-	-	-	-
Stage 2	0	-	-	-	-
Platoon blocked, %		1	1	-	-
Mov Cap-1 Maneuver	-	*545	*686	-	-
Mov Cap-2 Maneuver	-	-	-	-	-
Stage 1	-	-	-	-	-
Stage 2	-	-	-	-	-

Approach	EB	NB	SB
HCM Control Delay, s	11.6	0.1	0
HCM LOS	B		

Minor Lane/Major Mvmt	NBL	NBT	EBLn1	SBT	SBR
Capacity (veh/h)	* 686	-	545	-	-
HCM Lane V/C Ratio	0.011	-	0.004	-	-
HCM Control Delay (s)	10.3	-	11.6	-	-
HCM Lane LOS	B	-	B	-	-
HCM 95th %tile Q(veh)	0	-	0	-	-

Notes
 ~: Volume exceeds capacity \$: Delay exceeds 300s +: Computation Not Defined *: All major volume in platoon

Intersection												
Int Delay, s/veh	1.5											
Movement	EBL	EBT	EBR	WBL	WBT	WBR	NBL	NBT	NBR	SBL	SBT	SBR
Lane Configurations	↖	↗		↖	↗	↖	↖	↖↖↖	↖	↖	↖↖↖	↖
Traffic Vol, veh/h	12	4	17	15	1	81	15	830	48	85	1524	20
Future Vol, veh/h	12	4	17	15	1	81	15	830	48	85	1524	20
Conflicting Peds, #/hr	0	0	0	0	0	0	0	0	0	0	0	0
Sign Control	Stop	Stop	Stop	Stop	Stop	Stop	Free	Free	Free	Free	Free	Free
RT Channelized	-	-	None	-	-	None	-	-	None	-	-	None
Storage Length	100	-	-	80	-	115	200	-	205	195	-	100
Veh in Median Storage, #	-	0	-	-	0	-	-	0	-	-	0	-
Grade, %	-	0	-	-	0	-	-	0	-	-	0	-
Peak Hour Factor	92	92	92	92	92	92	92	92	92	92	92	92
Heavy Vehicles, %	2	2	2	2	2	2	2	2	2	2	2	2
Mvmt Flow	13	4	18	16	1	88	16	902	52	92	1657	22

Major/Minor	Minor2		Minor1		Major1			Major2				
Conflicting Flow All	2234	2827	829	1783	2797	451	1679	0	0	954	0	0
Stage 1	1841	1841	-	934	934	-	-	-	-	-	-	-
Stage 2	393	986	-	849	1863	-	-	-	-	-	-	-
Critical Hdwy	6.44	6.54	7.14	6.44	6.54	7.14	5.34	-	-	5.34	-	-
Critical Hdwy Stg 1	7.34	5.54	-	7.34	5.54	-	-	-	-	-	-	-
Critical Hdwy Stg 2	6.74	5.54	-	6.74	5.54	-	-	-	-	-	-	-
Follow-up Hdwy	3.82	4.02	3.92	3.82	4.02	3.92	3.12	-	-	3.12	-	-
Pot Cap-1 Maneuver	*112	33	*567	*262	35	*740	*713	-	-	833	-	-
Stage 1	*431	454	-	*674	668	-	-	-	-	-	-	-
Stage 2	*759	626	-	*582	439	-	-	-	-	-	-	-
Platoon blocked, %	1	1	1	1	1	1	1	-	-	1	-	-
Mov Cap-1 Maneuver	*86	28	*567	*201	30	*740	*713	-	-	833	-	-
Mov Cap-2 Maneuver	*86	28	-	*201	30	-	-	-	-	-	-	-
Stage 1	*421	404	-	*659	653	-	-	-	-	-	-	-
Stage 2	*653	612	-	*495	391	-	-	-	-	-	-	-

Approach	EB		WB		NB			SB		
HCM Control Delay, s	45.9		13.9		0.2			0.5		
HCM LOS	E		B							

Minor Lane/Major Mvmt	NBL	NBT	NBR	EBLn1	EBLn2	WBLn1	WBLn2	WBLn3	SBL	SBT	SBR
Capacity (veh/h)	*713	-	-	86	122	201	30	740	833	-	-
HCM Lane V/C Ratio	0.023	-	-	0.152	0.187	0.081	0.036	0.119	0.111	-	-
HCM Control Delay (s)	10.2	-	-	54.2	41.2	24.5	129.5	10.5	9.9	-	-
HCM Lane LOS	B	-	-	F	E	C	F	B	A	-	-
HCM 95th %tile Q(veh)	0.1	-	-	0.5	0.7	0.3	0.1	0.4	0.4	-	-

Notes
 ~: Volume exceeds capacity \$: Delay exceeds 300s +: Computation Not Defined *: All major volume in platoon

5: Scottsdale Road & Kierland Boulevard/Greenway Hayden Loop

08/18/2022



Movement	EBL	EBT	EBR	WBL	WBT	WBR	NBL	NBT	NBR	SBL	SBT	SBR
Lane Configurations	↔↔	↑↑	↗	↔↔	↑↑↑		↔↔	↑↑↑	↗	↔↔	↑↑↑	↗
Traffic Volume (veh/h)	50	145	44	267	192	51	44	810	422	160	1207	162
Future Volume (veh/h)	50	145	44	267	192	51	44	810	422	160	1207	162
Initial Q (Qb), veh	0	0	0	0	0	0	0	0	0	0	0	0
Ped-Bike Adj(A_pbT)	1.00		1.00	1.00		1.00	1.00		1.00	1.00		1.00
Parking Bus, Adj	1.00	1.00	1.00	1.00	1.00	1.00	1.00	1.00	1.00	1.00	1.00	1.00
Work Zone On Approach		No			No			No			No	
Adj Sat Flow, veh/h/ln	1870	1870	1870	1870	1870	1870	1870	1870	1870	1870	1870	1870
Adj Flow Rate, veh/h	54	158	48	290	209	55	48	880	459	174	1312	176
Peak Hour Factor	0.92	0.92	0.92	0.92	0.92	0.92	0.92	0.92	0.92	0.92	0.92	0.92
Percent Heavy Veh, %	2	2	2	2	2	2	2	2	2	2	2	2
Cap, veh/h	302	233	104	350	320	79	1217	1147	356	1444	1482	460
Arrive On Green	0.09	0.07	0.07	0.03	0.03	0.03	0.70	0.45	0.45	0.84	0.58	0.58
Sat Flow, veh/h	3456	3554	1585	3456	4077	1014	3456	5106	1585	3456	5106	1585
Grp Volume(v), veh/h	54	158	48	290	172	92	48	880	459	174	1312	176
Grp Sat Flow(s),veh/h/ln	1728	1777	1585	1728	1702	1688	1728	1702	1585	1728	1702	1585
Q Serve(g_s), s	1.7	5.2	1.8	10.0	6.0	6.5	0.5	17.4	20.2	1.1	26.6	7.2
Cycle Q Clear(g_c), s	1.7	5.2	1.8	10.0	6.0	6.5	0.5	17.4	20.2	1.1	26.6	7.2
Prop In Lane	1.00		1.00	1.00		0.60	1.00		1.00	1.00		1.00
Lane Grp Cap(c), veh/h	302	233	104	350	267	132	1217	1147	356	1444	1482	460
V/C Ratio(X)	0.18	0.68	0.46	0.83	0.65	0.69	0.04	0.77	1.29	0.12	0.89	0.38
Avail Cap(c_a), veh/h	308	841	375	415	916	454	1217	2055	638	1444	2055	638
HCM Platoon Ratio	1.00	1.00	1.00	0.33	0.33	0.33	2.00	2.00	2.00	2.00	2.00	2.00
Upstream Filter(I)	1.00	1.00	1.00	0.91	0.91	0.91	0.90	0.90	0.90	1.00	1.00	1.00
Uniform Delay (d), s/veh	50.8	54.8	14.6	57.0	56.8	57.0	11.6	30.4	18.5	5.8	23.4	19.4
Incr Delay (d2), s/veh	0.1	1.3	1.2	9.0	0.9	2.2	0.0	4.5	148.0	0.0	8.1	2.4
Initial Q Delay(d3),s/veh	0.0	0.0	0.0	0.0	0.0	0.0	0.0	0.0	0.0	0.0	0.0	0.0
%ile BackOfQ(50%),veh/ln	0.8	2.4	1.4	5.0	2.7	2.9	0.2	5.8	19.5	0.4	7.3	2.6
Unsig. Movement Delay, s/veh												
LnGrp Delay(d),s/veh	50.9	56.1	15.8	66.0	57.7	59.2	11.6	34.9	166.5	5.8	31.5	21.8
LnGrp LOS	D	E	B	E	E	E	B	C	F	A	C	C
Approach Vol, veh/h		260			554			1387			1662	
Approach Delay, s/veh		47.6			62.3			77.6			27.8	
Approach LOS		D			E			E			C	
Timer - Assigned Phs	1	2	3	4	5	6	7	8				
Phs Duration (G+Y+Rc), s	48.3	40.5	16.1	15.1	56.1	32.7	17.8	13.5				
Change Period (Y+Rc), s	6.0	5.7	* 5.6	* 5.7	6.0	5.7	5.6	* 5.6				
Max Green Setting (Gmax), s	6.0	48.3	* 11	* 32	6.0	48.3	14.4	* 28				
Max Q Clear Time (g_c+I1), s	2.5	28.6	3.7	8.5	3.1	22.2	12.0	7.2				
Green Ext Time (p_c), s	0.0	6.2	0.0	1.0	0.1	4.8	0.1	0.6				

Intersection Summary

HCM 6th Ctrl Delay	52.0
HCM 6th LOS	D

Notes

- User approved pedestrian interval to be less than phase max green.
- * HCM 6th computational engine requires equal clearance times for the phases crossing the barrier.

6: Scottsdale Road & Greenway Parkway/Butherus Drive

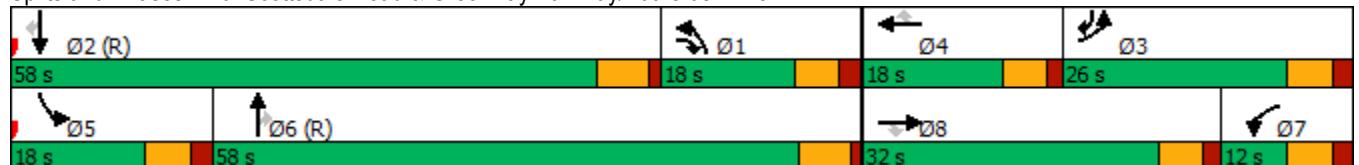
08/18/2022

Lane Group	EBL	EBT	EBR	WBL	WBT	WBR	NBL	NBT	NBR	SBL	SBT	SBR
Lane Configurations												
Traffic Volume (vph)	299	425	365	98	71	37	188	961	301	149	1242	106
Future Volume (vph)	299	425	365	98	71	37	188	961	301	149	1242	106
Turn Type	Prot	NA	pm+ov	Prot	NA	Perm	Prot	NA	Perm	Prot	NA	pm+ov
Protected Phases	3	8	1	7	4		1	6		5	2	3
Permitted Phases			8			4			6			2
Detector Phase	3	8	1	7	4	4	1	6	6	5	2	3
Switch Phase												
Minimum Initial (s)	5.0	7.0	5.0	5.0	7.0	7.0	5.0	10.0	10.0	5.0	10.0	5.0
Minimum Split (s)	11.0	13.2	11.0	11.0	13.2	13.2	11.0	16.0	16.0	11.0	16.0	11.0
Total Split (s)	26.0	32.0	18.0	12.0	18.0	18.0	18.0	58.0	58.0	18.0	58.0	26.0
Total Split (%)	21.7%	26.7%	15.0%	10.0%	15.0%	15.0%	15.0%	48.3%	48.3%	15.0%	48.3%	21.7%
Yellow Time (s)	4.0	4.0	4.0	4.0	4.0	4.0	4.0	4.7	4.7	4.0	4.7	4.0
All-Red Time (s)	2.0	1.5	2.0	2.0	1.5	1.5	2.0	1.0	1.0	2.0	1.0	2.0
Lost Time Adjust (s)	0.0	0.0	0.0	0.0	0.0	0.0	0.0	0.0	0.0	0.0	0.0	0.0
Total Lost Time (s)	6.0	5.5	6.0	6.0	5.5	5.5	6.0	5.7	5.7	6.0	5.7	6.0
Lead/Lag	Lag	Lead	Lag	Lag	Lead	Lead	Lag	Lag	Lag	Lead	Lead	Lag
Lead-Lag Optimize?	Yes	Yes	Yes	Yes	Yes	Yes	Yes	Yes	Yes	Yes	Yes	Yes
Recall Mode	None	None	None	None	None	None	None	C-Min	C-Min	None	C-Min	None
Act Effct Green (s)	26.6	24.4	42.9	7.3	7.6	7.6	12.9	55.3	55.3	9.8	52.2	84.5
Actuated g/C Ratio	0.22	0.20	0.36	0.06	0.06	0.06	0.11	0.46	0.46	0.08	0.44	0.70
v/c Ratio	0.43	0.87	0.44	0.52	0.34	0.12	0.55	0.45	0.39	0.58	0.61	0.10
Control Delay	42.6	57.9	14.9	63.8	57.9	0.8	55.8	23.5	9.5	49.6	31.3	1.5
Queue Delay	0.0	0.0	0.0	0.0	0.0	0.0	0.0	0.0	0.0	0.0	0.0	0.0
Total Delay	42.6	57.9	14.9	63.8	57.9	0.8	55.8	23.5	9.5	49.6	31.3	1.5
LOS	D	E	B	E	E	A	E	C	A	D	C	A
Approach Delay		44.2			50.5			24.8			31.0	
Approach LOS		D			D			C			C	

Intersection Summary

Cycle Length: 120
 Actuated Cycle Length: 120
 Offset: 53 (44%), Referenced to phase 2:SBT and 6:NBT, Start of 1st Green
 Natural Cycle: 65
 Control Type: Actuated-Coordinated
 Maximum v/c Ratio: 0.87
 Intersection Signal Delay: 33.2
 Intersection Capacity Utilization 68.5%
 Analysis Period (min) 15
 Intersection LOS: C
 ICU Level of Service C

Splits and Phases: 6: Scottsdale Road & Greenway Parkway/Butherus Drive



6: Scottsdale Road & Greenway Parkway/Butherus Drive

08/18/2022



Movement	EBL	EBT	EBR	WBL	WBT	WBR	NBL	NBT	NBR	SBL	SBT	SBR
Lane Configurations	↔↔	↕↔	↔↔	↔↔	↕↕	↔↔	↔↔	↕↕↕	↔↔	↔↔	↕↕↕	↔↔
Traffic Volume (veh/h)	299	425	365	98	71	37	188	961	301	149	1242	106
Future Volume (veh/h)	299	425	365	98	71	37	188	961	301	149	1242	106
Initial Q (Qb), veh	0	0	0	0	0	0	0	0	0	0	0	0
Ped-Bike Adj(A_pbT)	1.00		1.00	1.00		1.00	1.00		1.00	1.00		1.00
Parking Bus, Adj	1.00	1.00	1.00	1.00	1.00	1.00	1.00	1.00	1.00	1.00	1.00	1.00
Work Zone On Approach		No			No			No			No	
Adj Sat Flow, veh/h/ln	1870	1870	1870	1870	1870	1870	1870	1870	1870	1870	1870	1870
Adj Flow Rate, veh/h	325	628	286	107	77	40	204	1045	0	162	1350	115
Peak Hour Factor	0.92	0.92	0.92	0.92	0.92	0.92	0.92	0.92	0.92	0.92	0.92	0.92
Percent Heavy Veh, %	2	2	2	2	2	2	2	2	2	2	2	2
Cap, veh/h	641	720	733	158	207	92	933	2570		216	1523	758
Arrive On Green	0.18	0.19	0.19	0.05	0.06	0.06	0.27	0.50	0.00	0.12	0.60	0.60
Sat Flow, veh/h	3563	3741	1585	3456	3554	1585	3456	5106	1585	3456	5106	1585
Grp Volume(v), veh/h	325	628	286	107	77	40	204	1045	0	162	1350	115
Grp Sat Flow(s),veh/h/ln	1781	1870	1585	1728	1777	1585	1728	1702	1585	1728	1702	1585
Q Serve(g_s), s	9.9	19.6	0.0	3.7	2.5	2.4	5.5	15.3	0.0	5.4	27.2	0.0
Cycle Q Clear(g_c), s	9.9	19.6	0.0	3.7	2.5	2.4	5.5	15.3	0.0	5.4	27.2	0.0
Prop In Lane	1.00		1.00	1.00		1.00	1.00		1.00	1.00		1.00
Lane Grp Cap(c), veh/h	641	720	733	158	207	92	933	2570		216	1523	758
V/C Ratio(X)	0.51	0.87	0.39	0.68	0.37	0.43	0.22	0.41		0.75	0.89	0.15
Avail Cap(c_a), veh/h	641	826	778	173	370	165	933	2570		346	2225	976
HCM Platoon Ratio	1.00	1.00	1.00	1.00	1.00	1.00	1.00	1.00	1.00	2.00	2.00	2.00
Upstream Filter(I)	1.00	1.00	1.00	1.00	1.00	1.00	1.00	1.00	0.00	0.87	0.87	0.87
Uniform Delay (d), s/veh	44.4	47.0	21.2	56.4	54.4	37.8	34.0	18.6	0.0	51.6	22.5	9.8
Incr Delay (d2), s/veh	0.3	8.3	0.1	6.8	0.4	1.2	0.0	0.5	0.0	1.7	7.0	0.4
Initial Q Delay(d3),s/veh	0.0	0.0	0.0	0.0	0.0	0.0	0.0	0.0	0.0	0.0	0.0	0.0
%ile BackOfQ(50%),veh/ln	4.3	9.7	5.0	1.7	1.1	1.2	2.3	5.8	0.0	2.2	7.0	1.0
Unsig. Movement Delay, s/veh												
LnGrp Delay(d),s/veh	44.7	55.4	21.3	63.1	54.8	39.0	34.0	19.1	0.0	53.3	29.5	10.2
LnGrp LOS	D	E	C	E	D	D	C	B		D	C	B
Approach Vol, veh/h		1239			224			1249			1627	
Approach Delay, s/veh		44.7			55.9			21.5			30.5	
Approach LOS		D			E			C			C	
Timer - Assigned Phs	1	2	3	4	5	6	7	8				
Phs Duration (G+Y+Rc), s	38.4	41.5	27.6	12.5	13.5	66.4	11.5	28.6				
Change Period (Y+Rc), s	6.0	5.7	6.0	5.5	6.0	* 6	6.0	5.5				
Max Green Setting (Gmax), s	12.0	52.3	20.0	12.5	12.0	* 52	6.0	26.5				
Max Q Clear Time (g_c+I1), s	7.5	29.2	11.9	4.5	7.4	17.3	5.7	21.6				
Green Ext Time (p_c), s	0.1	6.6	0.4	0.2	0.1	4.9	0.0	1.5				

Intersection Summary

HCM 6th Ctrl Delay	33.3
HCM 6th LOS	C

Notes

- User approved pedestrian interval to be less than phase max green.
- User approved volume balancing among the lanes for turning movement.
- * HCM 6th computational engine requires equal clearance times for the phases crossing the barrier.

Intersection						
Int Delay, s/veh	1.7					
Movement	EBL	EBT	WBT	WBR	SBL	SBR
Lane Configurations						
Traffic Vol, veh/h	32	206	113	18	16	34
Future Vol, veh/h	32	206	113	18	16	34
Conflicting Peds, #/hr	0	0	0	0	0	0
Sign Control	Free	Free	Free	Free	Stop	Stop
RT Channelized	-	None	-	None	-	None
Storage Length	100	-	-	-	0	-
Veh in Median Storage, #	-	0	0	-	0	-
Grade, %	-	0	0	-	0	-
Peak Hour Factor	92	92	92	92	92	92
Heavy Vehicles, %	2	2	2	2	2	2
Mvmt Flow	35	224	123	20	17	37
Major/Minor	Major1	Major2	Minor2			
Conflicting Flow All	143	0	-	0	427	133
Stage 1	-	-	-	-	133	-
Stage 2	-	-	-	-	294	-
Critical Hdwy	4.12	-	-	-	6.42	6.22
Critical Hdwy Stg 1	-	-	-	-	5.42	-
Critical Hdwy Stg 2	-	-	-	-	5.42	-
Follow-up Hdwy	2.218	-	-	-	3.518	3.318
Pot Cap-1 Maneuver	1440	-	-	-	637	916
Stage 1	-	-	-	-	893	-
Stage 2	-	-	-	-	800	-
Platoon blocked, %		-	-	-	1	
Mov Cap-1 Maneuver	1440	-	-	-	622	916
Mov Cap-2 Maneuver	-	-	-	-	663	-
Stage 1	-	-	-	-	872	-
Stage 2	-	-	-	-	800	-
Approach	EB	WB	SB			
HCM Control Delay, s	1	0	9.7			
HCM LOS						A
Minor Lane/Major Mvmt	EBL	EBT	WBT	WBR	SBLn1	
Capacity (veh/h)	1440	-	-	-	816	
HCM Lane V/C Ratio	0.024	-	-	-	0.067	
HCM Control Delay (s)	7.6	-	-	-	9.7	
HCM Lane LOS	A	-	-	-	A	
HCM 95th %tile Q(veh)	0.1	-	-	-	0.2	

Intersection						
Int Delay, s/veh	2.2					
Movement	EBT	EBR	WBL	WBT	NBL	NBR
Lane Configurations						
Traffic Vol, veh/h	166	55	17	95	41	37
Future Vol, veh/h	166	55	17	95	41	37
Conflicting Peds, #/hr	0	0	0	0	0	0
Sign Control	Free	Free	Free	Free	Stop	Stop
RT Channelized	-	None	-	None	-	None
Storage Length	-	-	100	-	80	0
Veh in Median Storage, #	0	-	-	0	0	-
Grade, %	0	-	-	0	0	-
Peak Hour Factor	92	92	92	92	92	92
Heavy Vehicles, %	2	2	2	2	2	2
Mvmt Flow	180	60	18	103	45	40

Major/Minor	Major1	Major2	Minor1		
Conflicting Flow All	0	0	240	0	349 210
Stage 1	-	-	-	-	210 -
Stage 2	-	-	-	-	139 -
Critical Hdwy	-	-	4.12	-	6.42 6.22
Critical Hdwy Stg 1	-	-	-	-	5.42 -
Critical Hdwy Stg 2	-	-	-	-	5.42 -
Follow-up Hdwy	-	-	2.218	-	3.518 3.318
Pot Cap-1 Maneuver	-	-	1350	-	704 919
Stage 1	-	-	-	-	872 -
Stage 2	-	-	-	-	888 -
Platoon blocked, %	-	-	1	-	1 1
Mov Cap-1 Maneuver	-	-	1350	-	695 919
Mov Cap-2 Maneuver	-	-	-	-	716 -
Stage 1	-	-	-	-	872 -
Stage 2	-	-	-	-	876 -

Approach	EB	WB	NB
HCM Control Delay, s	0	1.2	9.8
HCM LOS			A

Minor Lane/Major Mvmt	NBLn1	NBLn2	EBT	EBR	WBL	WBT
Capacity (veh/h)	716	919	-	-	1350	-
HCM Lane V/C Ratio	0.062	0.044	-	-	0.014	-
HCM Control Delay (s)	10.4	9.1	-	-	7.7	-
HCM Lane LOS	B	A	-	-	A	-
HCM 95th %tile Q(veh)	0.2	0.1	-	-	0	-

Intersection						
Int Delay, s/veh	1.9					
Movement	WBL	WBR	NBT	NBR	SBL	SBT
Lane Configurations	↙	↗	↖		↙	↗
Traffic Vol, veh/h	7	10	63	33	27	48
Future Vol, veh/h	7	10	63	33	27	48
Conflicting Peds, #/hr	0	0	0	0	0	0
Sign Control	Stop	Stop	Free	Free	Free	Free
RT Channelized	-	None	-	None	-	None
Storage Length	75	0	-	-	100	-
Veh in Median Storage, #	0	-	0	-	-	0
Grade, %	0	-	0	-	-	0
Peak Hour Factor	92	92	92	92	92	92
Heavy Vehicles, %	2	2	2	2	2	2
Mvmt Flow	8	11	68	36	29	52

Major/Minor	Minor1	Major1	Major2		
Conflicting Flow All	196	86	0	0	104
Stage 1	86	-	-	-	-
Stage 2	110	-	-	-	-
Critical Hdwy	6.42	6.22	-	-	4.12
Critical Hdwy Stg 1	5.42	-	-	-	-
Critical Hdwy Stg 2	5.42	-	-	-	-
Follow-up Hdwy	3.518	3.318	-	-	2.218
Pot Cap-1 Maneuver	793	973	-	-	1488
Stage 1	937	-	-	-	-
Stage 2	915	-	-	-	-
Platoon blocked, %			-	-	-
Mov Cap-1 Maneuver	778	973	-	-	1488
Mov Cap-2 Maneuver	773	-	-	-	-
Stage 1	937	-	-	-	-
Stage 2	898	-	-	-	-

Approach	WB	NB	SB
HCM Control Delay, s	9.1	0	2.7
HCM LOS	A		

Minor Lane/Major Mvmt	NBT	NBRWBLn1	WBLn2	SBL	SBT
Capacity (veh/h)	-	-	773	973	1488
HCM Lane V/C Ratio	-	-	0.01	0.011	0.02
HCM Control Delay (s)	-	-	9.7	8.7	7.5
HCM Lane LOS	-	-	A	A	A
HCM 95th %tile Q(veh)	-	-	0	0	0.1

Intersection												
Int Delay, s/veh	0											
Movement	EBL	EBT	EBR	WBL	WBT	WBR	NBL	NBT	NBR	SBL	SBT	SBR
Lane Configurations		↕			↕		↕	↕		↕	↕	
Traffic Vol, veh/h	0	0	0	0	0	0	0	101	2	1	54	0
Future Vol, veh/h	0	0	0	0	0	0	0	101	2	1	54	0
Conflicting Peds, #/hr	0	0	0	0	0	0	0	0	0	0	0	0
Sign Control	Stop	Stop	Stop	Stop	Stop	Stop	Free	Free	Free	Free	Free	Free
RT Channelized	-	-	None	-	-	None	-	-	None	-	-	None
Storage Length	-	-	-	-	-	-	100	-	-	100	-	-
Veh in Median Storage, #	-	0	-	-	0	-	-	0	-	-	0	-
Grade, %	-	0	-	-	0	-	-	0	-	-	0	-
Peak Hour Factor	92	92	92	92	92	92	92	92	92	92	92	92
Heavy Vehicles, %	2	2	2	2	2	2	2	2	2	2	2	2
Mvmt Flow	0	0	0	0	0	0	0	110	2	1	59	0

Major/Minor	Minor2		Minor1		Major1			Major2				
Conflicting Flow All	172	173	59	172	172	111	59	0	0	112	0	0
Stage 1	61	61	-	111	111	-	-	-	-	-	-	-
Stage 2	111	112	-	61	61	-	-	-	-	-	-	-
Critical Hdwy	7.12	6.52	6.22	7.12	6.52	6.22	4.12	-	-	4.12	-	-
Critical Hdwy Stg 1	6.12	5.52	-	6.12	5.52	-	-	-	-	-	-	-
Critical Hdwy Stg 2	6.12	5.52	-	6.12	5.52	-	-	-	-	-	-	-
Follow-up Hdwy	3.518	4.018	3.318	3.518	4.018	3.318	2.218	-	-	2.218	-	-
Pot Cap-1 Maneuver	791	720	1007	791	721	942	1545	-	-	1478	-	-
Stage 1	950	844	-	894	804	-	-	-	-	-	-	-
Stage 2	894	803	-	950	844	-	-	-	-	-	-	-
Platoon blocked, %								-	-	-	-	-
Mov Cap-1 Maneuver	790	719	1007	790	720	942	1545	-	-	1478	-	-
Mov Cap-2 Maneuver	790	719	-	790	720	-	-	-	-	-	-	-
Stage 1	950	843	-	894	804	-	-	-	-	-	-	-
Stage 2	894	803	-	949	843	-	-	-	-	-	-	-

Approach	EB		WB		NB		SB	
HCM Control Delay, s	0		0		0		0.1	
HCM LOS	A		A					

Minor Lane/Major Mvmt	NBL	NBT	NBR	EBLn1WBLn1	SBL	SBT	SBR
Capacity (veh/h)	1545	-	-	-	1478	-	-
HCM Lane V/C Ratio	-	-	-	-	0.001	-	-
HCM Control Delay (s)	0	-	-	0	0	7.4	-
HCM Lane LOS	A	-	-	A	A	A	-
HCM 95th %tile Q(veh)	0	-	-	-	0	-	-

Intersection												
Int Delay, s/veh	0.8											
Movement	EBL	EBT	EBR	WBL	WBT	WBR	NBL	NBT	NBR	SBL	SBT	SBR
Lane Configurations	↖	↗		↖	↗			↕			↕	
Traffic Vol, veh/h	0	128	7	0	139	0	11	0	12	0	0	0
Future Vol, veh/h	0	128	7	0	139	0	11	0	12	0	0	0
Conflicting Peds, #/hr	0	0	0	0	0	0	0	0	0	0	0	0
Sign Control	Free	Free	Free	Free	Free	Free	Stop	Stop	Stop	Stop	Stop	Stop
RT Channelized	-	-	None	-	-	None	-	-	None	-	-	None
Storage Length	100	-	-	100	-	-	-	-	-	-	-	-
Veh in Median Storage, #	-	0	-	-	0	-	-	0	-	-	0	-
Grade, %	-	0	-	-	0	-	-	0	-	-	0	-
Peak Hour Factor	92	92	92	92	92	92	92	92	92	92	92	92
Heavy Vehicles, %	2	2	2	2	2	2	2	2	2	2	2	2
Mvmt Flow	0	139	8	0	151	0	12	0	13	0	0	0

Major/Minor	Major1			Major2			Minor1			Minor2		
Conflicting Flow All	151	0	0	147	0	0	294	294	143	301	298	151
Stage 1	-	-	-	-	-	-	143	143	-	151	151	-
Stage 2	-	-	-	-	-	-	151	151	-	150	147	-
Critical Hdwy	4.12	-	-	4.12	-	-	7.12	6.52	6.22	7.12	6.52	6.22
Critical Hdwy Stg 1	-	-	-	-	-	-	6.12	5.52	-	6.12	5.52	-
Critical Hdwy Stg 2	-	-	-	-	-	-	6.12	5.52	-	6.12	5.52	-
Follow-up Hdwy	2.218	-	-	2.218	-	-	3.518	4.018	3.318	3.518	4.018	3.318
Pot Cap-1 Maneuver	1430	-	-	1435	-	-	658	617	905	651	614	895
Stage 1	-	-	-	-	-	-	860	779	-	851	772	-
Stage 2	-	-	-	-	-	-	851	772	-	853	775	-
Platoon blocked, %	-	-	-	-	-	-	-	-	-	-	-	-
Mov Cap-1 Maneuver	1430	-	-	1435	-	-	658	617	905	642	614	895
Mov Cap-2 Maneuver	-	-	-	-	-	-	658	617	-	642	614	-
Stage 1	-	-	-	-	-	-	860	779	-	851	772	-
Stage 2	-	-	-	-	-	-	851	772	-	841	775	-

Approach	EB			WB			NB			SB		
HCM Control Delay, s	0			0			9.9			0		
HCM LOS							A			A		

Minor Lane/Major Mvmt	NBLn1	EBL	EBT	EBR	WBL	WBT	WBR	SBLn1
Capacity (veh/h)	767	1430	-	-	1435	-	-	-
HCM Lane V/C Ratio	0.033	-	-	-	-	-	-	-
HCM Control Delay (s)	9.9	0	-	-	0	-	-	0
HCM Lane LOS	A	A	-	-	A	-	-	A
HCM 95th %tile Q(veh)	0.1	0	-	-	0	-	-	-

Intersection	
Intersection Delay, s/veh	8.4
Intersection LOS	A

Movement	EBL	EBT	EBR	WBL	WBT	WBR	NBL	NBT	NBR	SBL	SBT	SBR
Lane Configurations	↶	↷		↶	↷		↶	↷		↶	↷	
Traffic Vol, veh/h	44	62	50	33	54	7	32	46	15	6	23	21
Future Vol, veh/h	44	62	50	33	54	7	32	46	15	6	23	21
Peak Hour Factor	0.92	0.92	0.92	0.92	0.92	0.92	0.92	0.92	0.92	0.92	0.92	0.92
Heavy Vehicles, %	2	2	2	2	2	2	2	2	2	2	2	2
Mvmt Flow	48	67	54	36	59	8	35	50	16	7	25	23
Number of Lanes	1	1	0	1	1	0	1	1	0	1	1	0

Approach	EB	WB	NB	SB
Opposing Approach	WB	EB	SB	NB
Opposing Lanes	2	2	2	2
Conflicting Approach Left	SB	NB	EB	WB
Conflicting Lanes Left	2	2	2	2
Conflicting Approach Right	NB	SB	WB	EB
Conflicting Lanes Right	2	2	2	2
HCM Control Delay	8.5	8.4	8.5	8.2
HCM LOS	A	A	A	A

Lane	NBLn1	NBLn2	EBLn1	EBLn2	WBLn1	WBLn2	SBLn1	SBLn2
Vol Left, %	100%	0%	100%	0%	100%	0%	100%	0%
Vol Thru, %	0%	75%	0%	55%	0%	89%	0%	52%
Vol Right, %	0%	25%	0%	45%	0%	11%	0%	48%
Sign Control	Stop	Stop	Stop	Stop	Stop	Stop	Stop	Stop
Traffic Vol by Lane	32	61	44	112	33	61	6	44
LT Vol	32	0	44	0	33	0	6	0
Through Vol	0	46	0	62	0	54	0	23
RT Vol	0	15	0	50	0	7	0	21
Lane Flow Rate	35	66	48	122	36	66	7	48
Geometry Grp	7	7	7	7	7	7	7	7
Degree of Util (X)	0.056	0.094	0.074	0.16	0.056	0.092	0.011	0.066
Departure Headway (Hd)	5.766	5.09	5.537	4.721	5.595	5.012	5.821	4.982
Convergence, Y/N	Yes	Yes	Yes	Yes	Yes	Yes	Yes	Yes
Cap	622	704	648	760	641	715	615	719
Service Time	3.494	2.818	3.263	2.448	3.325	2.742	3.553	2.714
HCM Lane V/C Ratio	0.056	0.094	0.074	0.161	0.056	0.092	0.011	0.067
HCM Control Delay	8.8	8.3	8.7	8.4	8.7	8.3	8.6	8.1
HCM Lane LOS	A	A	A	A	A	A	A	A
HCM 95th-tile Q	0.2	0.3	0.2	0.6	0.2	0.3	0	0.2

15: 73rd Street/Dial Boulevard & Greenway Hayden Loop

08/18/2022

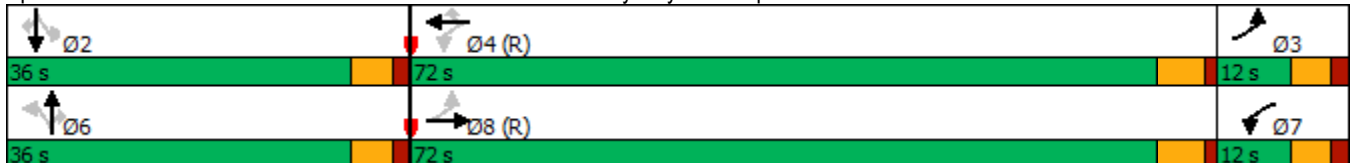


Lane Group	EBL	EBT	WBL	WBT	WBR	NBL	NBT	NBR	SBL	SBT	SBR
Lane Configurations	↘	↑↑↑	↘	↑↑	↗	↘	↑	↗	↘	↑	↗
Traffic Volume (vph)	33	551	214	444	33	39	59	245	84	62	65
Future Volume (vph)	33	551	214	444	33	39	59	245	84	62	65
Turn Type	pm+pt	NA	pm+pt	NA	Perm	Perm	NA	Perm	Perm	NA	Perm
Protected Phases	3	8	7	4			6			2	
Permitted Phases	8		4		4	6		6	2		2
Detector Phase	3	8	7	4	4	6	6	6	2	2	2
Switch Phase											
Minimum Initial (s)	5.0	10.0	5.0	10.0	10.0	7.0	7.0	7.0	7.0	7.0	7.0
Minimum Split (s)	12.0	37.0	37.0	36.0	36.0	37.0	37.0	37.0	37.0	37.0	37.0
Total Split (s)	12.0	72.0	12.0	72.0	72.0	36.0	36.0	36.0	36.0	36.0	36.0
Total Split (%)	10.0%	60.0%	10.0%	60.0%	60.0%	30.0%	30.0%	30.0%	30.0%	30.0%	30.0%
Yellow Time (s)	3.6	4.4	3.6	4.4	4.4	3.6	3.6	3.6	3.6	3.6	3.6
All-Red Time (s)	1.7	1.0	1.7	1.0	1.0	1.6	1.6	1.6	1.6	1.6	1.6
Lost Time Adjust (s)	0.0	0.0	0.0	0.0	0.0	0.0	0.0	0.0	0.0	0.0	0.0
Total Lost Time (s)	5.3	5.4	5.3	5.4	5.4	5.2	5.2	5.2	5.2	5.2	5.2
Lead/Lag	Lag	Lead	Lag	Lead	Lead						
Lead-Lag Optimize?	Yes	Yes	Yes	Yes	Yes						
Recall Mode	Max	C-Min	None	C-Min	C-Min	None	None	None	None	None	None
Act Effct Green (s)	90.9	36.7	92.0	37.2	37.2	12.7	12.7	12.7	12.7	12.7	12.7
Actuated g/C Ratio	0.76	0.31	0.77	0.31	0.31	0.11	0.11	0.11	0.11	0.11	0.11
v/c Ratio	0.04	0.42	0.24	0.44	0.07	0.30	0.32	0.66	0.65	0.34	0.31
Control Delay	5.1	35.1	4.7	25.7	2.0	53.1	52.4	13.8	71.2	52.8	14.0
Queue Delay	0.0	0.0	0.0	0.0	0.0	0.0	0.0	0.0	0.0	0.0	0.0
Total Delay	5.1	35.1	4.7	25.7	2.0	53.1	52.4	13.8	71.2	52.8	14.0
LOS	A	D	A	C	A	D	D	B	E	D	B
Approach Delay		33.6		18.0			24.9			48.1	
Approach LOS		C		B			C			D	

Intersection Summary

Cycle Length: 120
 Actuated Cycle Length: 120
 Offset: 47 (39%), Referenced to phase 4:WBTL and 8:EBTL, Start of Green
 Natural Cycle: 115
 Control Type: Actuated-Coordinated
 Maximum v/c Ratio: 0.66
 Intersection Signal Delay: 27.9
 Intersection Capacity Utilization 48.2%
 Analysis Period (min) 15
 Intersection LOS: C
 ICU Level of Service A

Splits and Phases: 15: 73rd Street/Dial Boulevard & Greenway Hayden Loop



15: 73rd Street/Dial Boulevard & Greenway Hayden Loop

08/18/2022



Movement	EBL	EBT	EBR	WBL	WBT	WBR	NBL	NBT	NBR	SBL	SBT	SBR
Lane Configurations	↖	↕↕↕		↖	↕↕	↖	↖	↕	↖	↖	↕	↖
Traffic Volume (veh/h)	33	551	52	214	444	33	39	59	245	84	62	65
Future Volume (veh/h)	33	551	52	214	444	33	39	59	245	84	62	65
Initial Q (Qb), veh	0	0	0	0	0	0	0	0	0	0	0	0
Ped-Bike Adj(A_pbT)	1.00		1.00	1.00		1.00	1.00		1.00	1.00		1.00
Parking Bus, Adj	1.00	1.00	1.00	1.00	1.00	1.00	1.00	1.00	1.00	1.00	1.00	1.00
Work Zone On Approach		No			No			No			No	
Adj Sat Flow, veh/h/ln	1870	1870	1870	1870	1870	1870	1870	1870	1870	1870	1870	1870
Adj Flow Rate, veh/h	36	599	57	233	483	36	42	64	266	91	67	71
Peak Hour Factor	0.92	0.92	0.92	0.92	0.92	0.92	0.92	0.92	0.92	0.92	0.92	0.92
Percent Heavy Veh, %	2	2	2	2	2	2	2	2	2	2	2	2
Cap, veh/h	1009	797	75	1008	595	265	254	347	294	225	347	294
Arrive On Green	0.17	0.06	0.06	0.51	0.17	0.17	0.19	0.19	0.19	0.19	0.19	0.19
Sat Flow, veh/h	1781	4746	447	1781	3554	1585	1251	1870	1585	1050	1870	1585
Grp Volume(v), veh/h	36	428	228	233	483	36	42	64	266	91	67	71
Grp Sat Flow(s),veh/h/ln	1781	1702	1790	1781	1777	1585	1251	1870	1585	1050	1870	1585
Q Serve(g_s), s	0.0	14.9	15.1	1.6	15.7	2.3	3.5	3.5	19.7	9.6	3.6	4.6
Cycle Q Clear(g_c), s	0.0	14.9	15.1	1.6	15.7	2.3	7.2	3.5	19.7	13.1	3.6	4.6
Prop In Lane	1.00		0.25	1.00		1.00	1.00		1.00	1.00		1.00
Lane Grp Cap(c), veh/h	1009	571	300	1008	595	265	254	347	294	225	347	294
V/C Ratio(X)	0.04	0.75	0.76	0.23	0.81	0.14	0.17	0.18	0.90	0.41	0.19	0.24
Avail Cap(c_a), veh/h	1009	1889	993	1008	1972	880	343	480	407	299	480	407
HCM Platoon Ratio	0.33	0.33	0.33	1.00	1.00	1.00	1.00	1.00	1.00	1.00	1.00	1.00
Upstream Filter(I)	0.87	0.87	0.87	1.00	1.00	1.00	1.00	1.00	1.00	1.00	1.00	1.00
Uniform Delay (d), s/veh	22.2	54.2	54.3	13.9	48.1	42.6	44.3	41.2	47.8	46.7	41.3	41.7
Incr Delay (d2), s/veh	0.1	7.7	14.5	0.0	11.5	1.1	0.1	0.1	15.4	0.4	0.1	0.2
Initial Q Delay(d3),s/veh	0.0	0.0	0.0	0.0	0.0	0.0	0.0	0.0	0.0	0.0	0.0	0.0
%ile BackOfQ(50%),veh/ln	0.8	7.4	8.5	3.1	7.9	1.0	1.1	1.6	9.0	2.5	1.7	1.8
Unsig. Movement Delay, s/veh												
LnGrp Delay(d),s/veh	22.3	61.8	68.8	13.9	59.6	43.6	44.4	41.3	63.2	47.1	41.4	41.8
LnGrp LOS	C	E	E	B	E	D	D	D	E	D	D	D
Approach Vol, veh/h		692			752			372			229	
Approach Delay, s/veh		62.1			44.7			57.3			43.8	
Approach LOS		E			D			E			D	
Timer - Assigned Phs		2	3	4		6	7	8				
Phs Duration (G+Y+Rc), s		27.5	67.0	25.5		27.5	67.0	25.5				
Change Period (Y+Rc), s		* 5.2	5.3	* 5.4		* 5.2	5.3	* 5.4				
Max Green Setting (Gmax), s		* 31	6.7	* 67		* 31	6.7	* 67				
Max Q Clear Time (g_c+I1), s		15.1	2.0	17.7		21.7	3.6	17.1				
Green Ext Time (p_c), s		0.5	0.0	2.4		0.6	0.1	3.1				

Intersection Summary

HCM 6th Ctrl Delay	52.8
HCM 6th LOS	D

Notes

User approved pedestrian interval to be less than phase max green.
 * HCM 6th computational engine requires equal clearance times for the phases crossing the barrier.

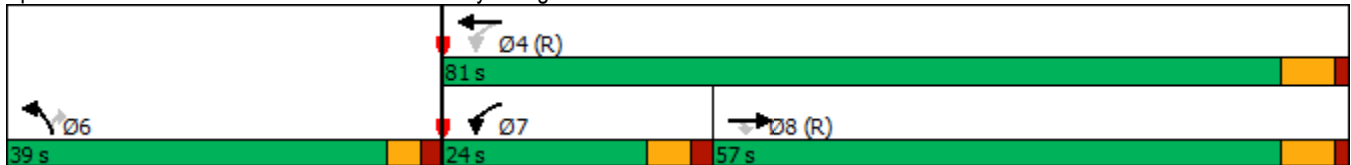


Lane Group	EBT	EBR	WBL	WBT	NBL	NBR
Lane Configurations	↑↑↑	↑	↓	↑↑↑	↓	↓
Traffic Volume (vph)	1542	106	201	922	48	126
Future Volume (vph)	1542	106	201	922	48	126
Turn Type	NA	Perm	pm+pt	NA	Prot	Perm
Protected Phases	8		7	4	6	
Permitted Phases		8	4			6
Detector Phase	8	8	7	4	6	6
Switch Phase						
Minimum Initial (s)	7.0	7.0	5.0	10.0	7.0	7.0
Minimum Split (s)	13.2	13.2	11.0	16.2	12.0	12.0
Total Split (s)	57.0	57.0	24.0	81.0	39.0	39.0
Total Split (%)	47.5%	47.5%	20.0%	67.5%	32.5%	32.5%
Yellow Time (s)	4.7	4.7	4.0	4.7	3.0	3.0
All-Red Time (s)	1.5	1.5	1.9	1.5	2.0	2.0
Lost Time Adjust (s)	0.0	0.0	0.0	0.0	0.0	0.0
Total Lost Time (s)	6.2	6.2	5.9	6.2	5.0	5.0
Lead/Lag	Lag	Lag	Lead			
Lead-Lag Optimize?	Yes	Yes	Yes			
Recall Mode	C-Min	C-Min	None	C-Min	None	None
Act Effct Green (s)	84.2	84.2	101.2	100.9	7.9	7.9
Actuated g/C Ratio	0.70	0.70	0.84	0.84	0.07	0.07
v/c Ratio	0.47	0.10	0.71	0.23	0.23	0.59
Control Delay	5.3	3.4	37.9	0.8	55.1	19.6
Queue Delay	0.0	0.0	0.0	0.0	0.0	0.0
Total Delay	5.3	3.4	37.9	0.8	55.1	19.6
LOS	A	A	D	A	E	B
Approach Delay	5.1			7.4	29.4	
Approach LOS	A			A	C	

Intersection Summary

Cycle Length: 120
 Actuated Cycle Length: 120
 Offset: 75 (63%), Referenced to phase 4:WBTL and 8:EBT, Start of 1st Green
 Natural Cycle: 55
 Control Type: Actuated-Coordinated
 Maximum v/c Ratio: 0.71
 Intersection Signal Delay: 7.4
 Intersection Capacity Utilization 61.0%
 Analysis Period (min) 15
 Intersection LOS: A
 ICU Level of Service B

Splits and Phases: 16: 76th Street & Frank Lloyd Wright Boulevard





Movement	EBT	EBR	WBL	WBT	NBL	NBR	
Lane Configurations	↑↑↑	↑	↑	↑↑↑	↑↑	↑	
Traffic Volume (veh/h)	1542	106	201	922	48	126	
Future Volume (veh/h)	1542	106	201	922	48	126	
Initial Q (Qb), veh	0	0	0	0	0	0	
Ped-Bike Adj(A_pbT)		1.00	1.00		1.00	1.00	
Parking Bus, Adj	1.00	1.00	1.00	1.00	1.00	1.00	
Work Zone On Approach	No			No	No		
Adj Sat Flow, veh/h/ln	1870	1870	1870	1870	1870	1870	
Adj Flow Rate, veh/h	1676	115	218	1002	52	137	
Peak Hour Factor	0.92	0.92	0.92	0.92	0.92	0.92	
Percent Heavy Veh, %	2	2	2	2	2	2	
Cap, veh/h	3582	1112	263	4099	359	165	
Arrive On Green	0.23	0.23	0.10	1.00	0.10	0.10	
Sat Flow, veh/h	5274	1585	1781	5274	3456	1585	
Grp Volume(v), veh/h	1676	115	218	1002	52	137	
Grp Sat Flow(s),veh/h/ln	1702	1585	1781	1702	1728	1585	
Q Serve(g_s), s	33.9	6.9	4.2	0.0	1.6	10.2	
Cycle Q Clear(g_c), s	33.9	6.9	4.2	0.0	1.6	10.2	
Prop In Lane		1.00	1.00		1.00	1.00	
Lane Grp Cap(c), veh/h	3582	1112	263	4099	359	165	
V/C Ratio(X)	0.47	0.10	0.83	0.24	0.14	0.83	
Avail Cap(c_a), veh/h	3582	1112	439	4099	979	449	
HCM Platoon Ratio	0.33	0.33	2.00	2.00	1.00	1.00	
Upstream Filter(I)	0.53	0.53	0.87	0.87	1.00	1.00	
Uniform Delay (d), s/veh	26.8	16.4	20.0	0.0	48.9	52.7	
Incr Delay (d2), s/veh	0.2	0.1	2.2	0.1	0.1	4.1	
Initial Q Delay(d3),s/veh	0.0	0.0	0.0	0.0	0.0	0.0	
%ile BackOfQ(50%),veh/ln	15.4	2.4	4.4	0.0	0.7	8.8	
Unsig. Movement Delay, s/veh							
LnGrp Delay(d),s/veh	27.0	16.5	22.2	0.1	49.0	56.9	
LnGrp LOS	C	B	C	A	D	E	
Approach Vol, veh/h	1791			1220	189		
Approach Delay, s/veh	26.4			4.1	54.7		
Approach LOS	C			A	D		
Timer - Assigned Phs				4	6	7	8
Phs Duration (G+Y+Rc), s				102.5	17.5	12.2	90.4
Change Period (Y+Rc), s				6.2	5.0	* 5.9	6.2
Max Green Setting (Gmax), s				74.8	34.0	* 18	50.8
Max Q Clear Time (g_c+I1), s				2.0	12.2	6.2	35.9
Green Ext Time (p_c), s				1.2	0.3	0.0	2.2

Intersection Summary

HCM 6th Ctrl Delay	19.5
HCM 6th LOS	B

Notes

User approved pedestrian interval to be less than phase max green.

* HCM 6th computational engine requires equal clearance times for the phases crossing the barrier.

Intersection

Intersection Delay, s/veh 9.3

Intersection LOS A

Movement	EBL	EBT	EBR	WBL	WBT	WBR	NBL	NBT	NBR	SBL	SBT	SBR
Lane Configurations												
Traffic Vol, veh/h	38	92	49	21	50	24	4	72	10	32	126	37
Future Vol, veh/h	38	92	49	21	50	24	4	72	10	32	126	37
Peak Hour Factor	0.92	0.92	0.92	0.92	0.92	0.92	0.92	0.92	0.92	0.92	0.92	0.92
Heavy Vehicles, %	2	2	2	2	2	2	2	2	2	2	2	2
Mvmt Flow	41	100	53	23	54	26	4	78	11	35	137	40
Number of Lanes	1	1	0	1	1	0	1	1	0	1	1	0

Approach	EB	WB	NB	SB
Opposing Approach	WB	EB	SB	NB
Opposing Lanes	2	2	2	2
Conflicting Approach Left	SB	NB	EB	WB
Conflicting Lanes Left	2	2	2	2
Conflicting Approach Right	NB	SB	WB	EB
Conflicting Lanes Right	2	2	2	2
HCM Control Delay	9.3	8.9	9.1	9.7
HCM LOS	A	A	A	A

Lane	NBLn1	NBLn2	EBLn1	EBLn2	WBLn1	WBLn2	SBLn1	SBLn2
Vol Left, %	100%	0%	100%	0%	100%	0%	100%	0%
Vol Thru, %	0%	88%	0%	65%	0%	68%	0%	77%
Vol Right, %	0%	12%	0%	35%	0%	32%	0%	23%
Sign Control	Stop	Stop	Stop	Stop	Stop	Stop	Stop	Stop
Traffic Vol by Lane	4	82	38	141	21	74	32	163
LT Vol	4	0	38	0	21	0	32	0
Through Vol	0	72	0	92	0	50	0	126
RT Vol	0	10	0	49	0	24	0	37
Lane Flow Rate	4	89	41	153	23	80	35	177
Geometry Grp	7	7	7	7	7	7	7	7
Degree of Util (X)	0.007	0.135	0.068	0.221	0.038	0.119	0.057	0.258
Departure Headway (Hd)	6.043	5.453	5.947	5.198	6.052	5.32	5.907	5.244
Convergence, Y/N	Yes	Yes	Yes	Yes	Yes	Yes	Yes	Yes
Cap	589	653	600	687	588	669	604	682
Service Time	3.815	3.224	3.708	2.959	3.822	3.088	3.667	3.004
HCM Lane V/C Ratio	0.007	0.136	0.068	0.223	0.039	0.12	0.058	0.26
HCM Control Delay	8.9	9.1	9.1	9.4	9.1	8.8	9	9.8
HCM Lane LOS	A	A	A	A	A	A	A	A
HCM 95th-tile Q	0	0.5	0.2	0.8	0.1	0.4	0.2	1

18: Greenway Hayden Loop & Frank Lloyd Wright Boulevard

08/18/2022

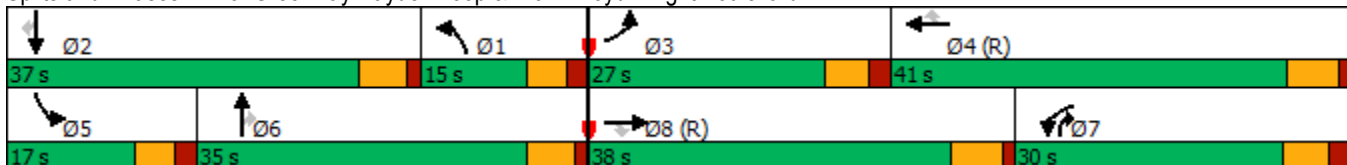


Lane Group	EBL	EBT	EBR	WBL	WBT	WBR	NBL	NBT	NBR	SBL	SBT	SBR
Lane Configurations	↖↗	↑↑↑	↗	↖↗	↑↑↑	↗	↖	↑↑	↗	↖↗	↑↑	↗
Traffic Volume (vph)	321	1227	62	578	993	172	13	373	400	240	616	265
Future Volume (vph)	321	1227	62	578	993	172	13	373	400	240	616	265
Turn Type	Prot	NA	Perm	Prot	NA	Perm	Prot	NA	pm+ov	Prot	NA	Perm
Protected Phases	3	8		7	4		1	6	7	5	2	
Permitted Phases			8			4			6			2
Detector Phase	3	8	8	7	4	4	1	6	7	5	2	2
Switch Phase												
Minimum Initial (s)	5.0	10.0	10.0	5.0	10.0	10.0	5.0	7.0	5.0	5.0	7.0	7.0
Minimum Split (s)	11.0	15.9	15.9	11.0	15.9	15.9	11.0	13.0	11.0	11.0	13.0	13.0
Total Split (s)	27.0	38.0	38.0	30.0	41.0	41.0	15.0	35.0	30.0	17.0	37.0	37.0
Total Split (%)	22.5%	31.7%	31.7%	25.0%	34.2%	34.2%	12.5%	29.2%	25.0%	14.2%	30.8%	30.8%
Yellow Time (s)	4.0	4.7	4.7	4.0	4.7	4.7	3.6	4.4	4.0	3.6	4.4	4.4
All-Red Time (s)	2.0	1.0	1.0	2.0	1.0	1.0	2.0	1.2	2.0	2.0	1.2	1.2
Lost Time Adjust (s)	0.0	0.0	0.0	0.0	0.0	0.0	0.0	0.0	0.0	0.0	0.0	0.0
Total Lost Time (s)	6.0	5.7	5.7	6.0	5.7	5.7	5.6	5.6	6.0	5.6	5.6	5.6
Lead/Lag	Lead	Lead	Lead	Lag	Lag	Lag	Lag	Lag	Lag	Lead	Lead	Lead
Lead-Lag Optimize?	Yes	Yes	Yes	Yes	Yes	Yes	Yes	Yes	Yes	Yes	Yes	Yes
Recall Mode	None	C-Min	C-Min	None	C-Min	C-Min	None	None	None	None	None	None
Act Effct Green (s)	15.6	43.4	43.4	23.4	51.1	51.1	5.7	19.2	42.2	11.1	31.1	31.1
Actuated g/C Ratio	0.13	0.36	0.36	0.20	0.43	0.43	0.05	0.16	0.35	0.09	0.26	0.26
v/c Ratio	0.78	0.73	0.10	0.94	0.50	0.24	0.17	0.71	0.68	0.82	0.73	0.48
Control Delay	75.0	39.9	1.8	70.7	27.7	5.4	38.9	32.5	19.2	74.3	46.1	8.6
Queue Delay	0.0	0.0	0.0	0.0	0.0	0.0	0.0	0.0	0.0	0.0	0.0	0.0
Total Delay	75.0	39.9	1.8	70.7	27.7	5.4	38.9	32.5	19.2	74.3	46.1	8.6
LOS	E	D	A	E	C	A	D	C	B	E	D	A
Approach Delay		45.4			39.8			25.9			43.3	
Approach LOS		D			D			C			D	

Intersection Summary

Cycle Length: 120
 Actuated Cycle Length: 120
 Offset: 93 (78%), Referenced to phase 4:WBT and 8:EBT, Start of 1st Green
 Natural Cycle: 90
 Control Type: Actuated-Coordinated
 Maximum v/c Ratio: 0.94
 Intersection Signal Delay: 40.2
 Intersection LOS: D
 Intersection Capacity Utilization 80.5%
 ICU Level of Service D
 Analysis Period (min) 15

Splits and Phases: 18: Greenway Hayden Loop & Frank Lloyd Wright Boulevard



18: Greenway Hayden Loop & Frank Lloyd Wright Boulevard

08/18/2022



Movement	EBL	EBT	EBR	WBL	WBT	WBR	NBL	NBT	NBR	SBL	SBT	SBR
Lane Configurations	↔↔	↑↑↑	↔	↔↔	↑↑↑	↔	↔	↑↑	↔	↔↔	↑↑	↔
Traffic Volume (veh/h)	321	1227	62	578	993	172	13	373	400	240	616	265
Future Volume (veh/h)	321	1227	62	578	993	172	13	373	400	240	616	265
Initial Q (Qb), veh	0	0	0	0	0	0	0	0	0	0	0	0
Ped-Bike Adj(A_pbT)	1.00		1.00	1.00		1.00	1.00		1.00	1.00		1.00
Parking Bus, Adj	1.00	1.00	1.00	1.00	1.00	1.00	1.00	1.00	1.00	1.00	1.00	1.00
Work Zone On Approach		No			No			No			No	
Adj Sat Flow, veh/h/ln	1870	1870	1870	1870	1870	1870	1870	1870	1870	1870	1870	1870
Adj Flow Rate, veh/h	349	1334	67	628	1079	187	14	405	435	261	670	288
Peak Hour Factor	0.92	0.92	0.92	0.92	0.92	0.92	0.92	0.92	0.92	0.92	0.92	0.92
Percent Heavy Veh, %	2	2	2	2	2	2	2	2	2	2	2	2
Cap, veh/h	399	1374	427	1081	2369	735	30	484	711	315	748	334
Arrive On Green	0.23	0.54	0.54	0.31	0.46	0.46	0.02	0.14	0.14	0.09	0.21	0.21
Sat Flow, veh/h	3456	5106	1585	3456	5106	1585	1781	3554	1585	3456	3554	1585
Grp Volume(v), veh/h	349	1334	67	628	1079	187	14	405	435	261	670	288
Grp Sat Flow(s),veh/h/ln	1728	1702	1585	1728	1702	1585	1781	1777	1585	1728	1777	1585
Q Serve(g_s), s	11.7	30.3	2.6	18.3	17.2	8.6	0.9	13.3	6.3	8.9	22.0	15.4
Cycle Q Clear(g_c), s	11.7	30.3	2.6	18.3	17.2	8.6	0.9	13.3	6.3	8.9	22.0	15.4
Prop In Lane	1.00		1.00	1.00		1.00	1.00		1.00	1.00		1.00
Lane Grp Cap(c), veh/h	399	1374	427	1081	2369	735	30	484	711	315	748	334
V/C Ratio(X)	0.88	0.97	0.16	0.58	0.46	0.25	0.47	0.84	0.61	0.83	0.90	0.86
Avail Cap(c_a), veh/h	605	1374	427	1081	2369	735	140	871	884	328	930	415
HCM Platoon Ratio	2.00	2.00	2.00	1.00	1.00	1.00	1.00	1.00	1.00	1.00	1.00	1.00
Upstream Filter(I)	0.87	0.87	0.87	1.00	1.00	1.00	1.00	1.00	1.00	1.00	1.00	1.00
Uniform Delay (d), s/veh	45.3	27.2	20.8	34.6	21.9	19.5	58.5	50.5	9.9	53.6	46.1	24.4
Incr Delay (d2), s/veh	5.6	16.7	0.7	0.5	0.6	0.8	4.2	1.5	0.3	14.5	8.5	12.4
Initial Q Delay(d3),s/veh	0.0	0.0	0.0	0.0	0.0	0.0	0.0	0.0	0.0	0.0	0.0	0.0
%ile BackOfQ(50%),veh/ln	4.6	9.8	1.0	7.5	6.7	3.2	0.5	5.9	4.3	4.4	10.4	6.7
Unsig. Movement Delay, s/veh												
LnGrp Delay(d),s/veh	50.9	43.9	21.5	35.2	22.5	20.4	62.7	52.0	10.2	68.1	54.6	36.8
LnGrp LOS	D	D	C	D	C	C	E	D	B	E	D	D
Approach Vol, veh/h		1750			1894			854			1219	
Approach Delay, s/veh		44.4			26.5			30.9			53.3	
Approach LOS		D			C			C			D	
Timer - Assigned Phs	1	2	3	4	5	6	7	8				
Phs Duration (G+Y+Rc), s	7.6	30.9	19.8	61.7	16.5	21.9	43.5	38.0				
Change Period (Y+Rc), s	* 5.6	5.6	6.0	* 6	5.6	* 5.6	6.0	5.7				
Max Green Setting (Gmax), s	* 9.4	31.4	21.0	* 35	11.4	* 29	24.0	32.3				
Max Q Clear Time (g_c+I1), s	2.9	24.0	13.7	19.2	10.9	15.3	20.3	32.3				
Green Ext Time (p_c), s	0.0	1.3	0.2	2.5	0.0	1.0	0.2	0.0				

Intersection Summary

HCM 6th Ctrl Delay	38.3
HCM 6th LOS	D

Notes

- User approved pedestrian interval to be less than phase max green.
- * HCM 6th computational engine requires equal clearance times for the phases crossing the barrier.

Intersection												
Int Delay, s/veh	1.5											
Movement	EBL	EBT	EBR	WBL	WBT	WBR	NBL	NBT	NBR	SBL	SBT	SBR
Lane Configurations		↕	↗		↕	↗	↖	↕	↗	↖	↕	↗
Traffic Vol, veh/h	7	7	16	13	5	27	17	753	35	57	1099	76
Future Vol, veh/h	7	7	16	13	5	27	17	753	35	57	1099	76
Conflicting Peds, #/hr	0	0	0	0	0	0	0	0	0	0	0	0
Sign Control	Stop	Stop	Stop	Stop	Stop	Stop	Free	Free	Free	Free	Free	Free
RT Channelized	-	-	None	-	-	None	-	-	None	-	-	None
Storage Length	-	-	130	-	-	130	150	-	-	110	-	175
Veh in Median Storage, #	-	0	-	-	0	-	-	0	-	-	0	-
Grade, %	-	0	-	-	0	-	-	0	-	-	0	-
Peak Hour Factor	92	92	92	92	92	92	92	92	92	92	92	92
Heavy Vehicles, %	2	2	2	2	2	2	2	2	2	2	2	2
Mvmt Flow	8	8	17	14	5	29	18	818	38	62	1195	83

Major/Minor	Minor2		Minor1		Major1			Major2				
Conflicting Flow All	1767	2211	598	1580	2256	409	1278	0	0	856	0	0
Stage 1	1319	1319	-	854	854	-	-	-	-	-	-	-
Stage 2	448	892	-	726	1402	-	-	-	-	-	-	-
Critical Hdwy	7.54	6.54	6.94	7.54	6.54	6.94	4.14	-	-	4.14	-	-
Critical Hdwy Stg 1	6.54	5.54	-	6.54	5.54	-	-	-	-	-	-	-
Critical Hdwy Stg 2	6.54	5.54	-	6.54	5.54	-	-	-	-	-	-	-
Follow-up Hdwy	3.52	4.02	3.32	3.52	4.02	3.32	2.22	-	-	2.22	-	-
Pot Cap-1 Maneuver	139	57	*633	*237	51	592	907	-	-	780	-	-
Stage 1	508	464	-	*320	373	-	-	-	-	-	-	-
Stage 2	560	358	-	*596	402	-	-	-	-	-	-	-
Platoon blocked, %	1	1	1	1	1	1	1	-	-	-	-	-
Mov Cap-1 Maneuver	111	52	*633	*189	46	592	907	-	-	780	-	-
Mov Cap-2 Maneuver	111	52	-	*189	46	-	-	-	-	-	-	-
Stage 1	497	427	-	*314	366	-	-	-	-	-	-	-
Stage 2	514	351	-	*524	371	-	-	-	-	-	-	-

Approach	EB	WB	NB	SB
HCM Control Delay, s	38	26.4	0.2	0.5
HCM LOS	E	D		

Minor Lane/Major Mvmt	NBL	NBT	NBR	EBLn1	EBLn2	WBLn1	WBLn2	SBL	SBT	SBR
Capacity (veh/h)	907	-	-	71	633	101	592	780	-	-
HCM Lane V/C Ratio	0.02	-	-	0.214	0.027	0.194	0.05	0.079	-	-
HCM Control Delay (s)	9.1	-	-	69	10.8	49	11.4	10	-	-
HCM Lane LOS	A	-	-	F	B	E	B	B	-	-
HCM 95th %tile Q(veh)	0.1	-	-	0.7	0.1	0.7	0.2	0.3	-	-

Notes
 ~: Volume exceeds capacity \$: Delay exceeds 300s +: Computation Not Defined *: All major volume in platoon

1: Scottsdale Road & Bell Road/Frank Lloyd Wright Boulevard

08/18/2022



Movement	EBL	EBT	EBR	WBL	WBT	WBR	NBL	NBT	NBR	SBL	SBT	SBR
Lane Configurations												
Traffic Volume (veh/h)	336	717	200	161	1109	590	314	1441	209	423	1160	328
Future Volume (veh/h)	336	717	200	161	1109	590	314	1441	209	423	1160	328
Initial Q (Qb), veh	0	0	0	0	0	0	0	0	0	0	0	0
Ped-Bike Adj(A_pbT)	1.00		1.00	1.00		1.00	1.00		1.00	1.00		1.00
Parking Bus, Adj	1.00	1.00	1.00	1.00	1.00	1.00	1.00	1.00	1.00	1.00	1.00	1.00
Work Zone On Approach		No			No			No			No	
Adj Sat Flow, veh/h/ln	1870	1870	1870	1870	1870	1870	1870	1870	1870	1870	1870	1870
Adj Flow Rate, veh/h	365	779	217	175	1205	641	341	1566	227	460	1261	357
Peak Hour Factor	0.92	0.92	0.92	0.92	0.92	0.92	0.92	0.92	0.92	0.92	0.92	0.92
Percent Heavy Veh, %	2	2	2	2	2	2	2	2	2	2	2	2
Cap, veh/h	317	1362	423	230	1242	650	374	1540	478	576	1417	401
Arrive On Green	0.09	0.27	0.27	0.02	0.08	0.08	0.04	0.10	0.10	0.17	0.36	0.36
Sat Flow, veh/h	3456	5106	1585	3456	5106	1585	3456	5106	1585	3456	3955	1118
Grp Volume(v), veh/h	365	779	217	175	1205	641	341	1566	227	460	1085	533
Grp Sat Flow(s),veh/h/ln	1728	1702	1585	1728	1702	1585	1728	1702	1585	1728	1702	1669
Q Serve(g_s), s	11.0	15.8	14.0	6.0	28.2	28.4	11.8	36.2	12.4	15.4	36.0	36.1
Cycle Q Clear(g_c), s	11.0	15.8	14.0	6.0	28.2	28.4	11.8	36.2	12.4	15.4	36.0	36.1
Prop In Lane	1.00		1.00	1.00		1.00	1.00		1.00	1.00		0.67
Lane Grp Cap(c), veh/h	317	1362	423	230	1242	650	374	1540	478	576	1220	598
V/C Ratio(X)	1.15	0.57	0.51	0.76	0.97	0.99	0.91	1.02	0.47	0.80	0.89	0.89
Avail Cap(c_a), veh/h	317	1370	425	230	1242	650	374	1540	478	576	1225	601
HCM Platoon Ratio	1.00	1.00	1.00	0.33	0.33	0.33	0.33	0.33	0.33	1.00	1.00	1.00
Upstream Filter(I)	1.00	1.00	1.00	0.88	0.88	0.88	0.79	0.79	0.79	1.00	1.00	1.00
Uniform Delay (d), s/veh	54.5	38.1	37.4	57.7	54.7	44.8	57.3	54.0	26.3	48.1	36.3	36.3
Incr Delay (d2), s/veh	98.4	0.4	0.4	11.0	17.1	29.5	21.2	24.6	2.7	7.2	9.9	18.0
Initial Q Delay(d3),s/veh	0.0	0.0	0.0	0.0	0.0	0.0	0.0	0.0	0.0	0.0	0.0	0.0
%ile BackOfQ(50%),veh/ln	9.0	6.4	5.3	3.0	14.8	17.0	6.5	20.0	5.5	7.0	15.9	16.9
Unsig. Movement Delay, s/veh												
LnGrp Delay(d),s/veh	152.9	38.4	37.8	68.7	71.9	74.4	78.5	78.7	28.9	55.3	46.2	54.3
LnGrp LOS	F	D	D	E	E	E	E	F	C	E	D	D
Approach Vol, veh/h		1361			2021			2134			2078	
Approach Delay, s/veh		69.0			72.4			73.3			50.3	
Approach LOS		E			E			E			D	
Timer - Assigned Phs	1	2	3	4	5	6	7	8				
Phs Duration (G+Y+Rc), s	19.0	49.0	17.0	35.0	26.0	42.0	14.0	38.0				
Change Period (Y+Rc), s	6.0	* 6	* 6	5.8	* 6	5.8	6.0	* 6				
Max Green Setting (Gmax), s	13.0	* 43	* 11	29.2	* 20	36.2	8.0	* 32				
Max Q Clear Time (g_c+I1), s	13.8	38.1	13.0	30.4	17.4	38.2	8.0	17.8				
Green Ext Time (p_c), s	0.0	2.2	0.0	0.0	0.3	0.0	0.0	1.7				

Intersection Summary

HCM 6th Ctrl Delay	66.0
HCM 6th LOS	E

Notes

- User approved pedestrian interval to be less than phase max green.
- * HCM 6th computational engine requires equal clearance times for the phases crossing the barrier.

2: Scottsdale Road & Paradise Lane

08/18/2022

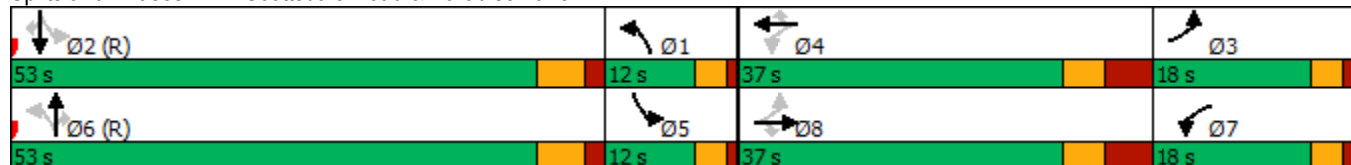


Lane Group	EBL	EBT	EBR	WBL	WBT	WBR	NBL	NBT	NBR	SBL	SBT	SBR
Lane Configurations	↘	↑	↗	↘	↑	↗	↘	↑↑↑	↗	↘	↑↑↑	↗
Traffic Volume (vph)	112	29	20	146	32	187	13	1638	77	60	1365	28
Future Volume (vph)	112	29	20	146	32	187	13	1638	77	60	1365	28
Turn Type	pm+pt	NA	Perm	pm+pt	NA	Perm	pm+pt	NA	Perm	pm+pt	NA	Perm
Protected Phases	3	8		7	4		1	6		5	2	
Permitted Phases	8		8	4		4	6		6	2		2
Detector Phase	3	8	8	7	4	4	1	6	6	5	2	2
Switch Phase												
Minimum Initial (s)	4.0	7.0	7.0	4.0	7.0	7.0	4.0	10.0	10.0	4.0	10.0	10.0
Minimum Split (s)	10.0	15.0	15.0	11.0	15.0	15.0	11.0	16.0	16.0	11.0	16.0	16.0
Total Split (s)	18.0	37.0	37.0	18.0	37.0	37.0	12.0	53.0	53.0	12.0	53.0	53.0
Total Split (%)	15.0%	30.8%	30.8%	15.0%	30.8%	30.8%	10.0%	44.2%	44.2%	10.0%	44.2%	44.2%
Yellow Time (s)	3.0	3.7	3.7	3.0	3.7	3.7	3.0	4.3	4.3	3.0	4.3	4.3
All-Red Time (s)	1.0	4.3	4.3	1.0	4.3	4.3	1.0	1.7	1.7	1.0	1.7	1.7
Lost Time Adjust (s)	0.0	0.0	0.0	0.0	0.0	0.0	0.0	0.0	0.0	0.0	0.0	0.0
Total Lost Time (s)	4.0	8.0	8.0	4.0	8.0	8.0	4.0	6.0	6.0	4.0	6.0	6.0
Lead/Lag	Lag	Lead	Lead	Lag	Lead	Lead	Lag	Lead	Lead	Lag	Lead	Lead
Lead-Lag Optimize?	Yes	Yes	Yes	Yes	Yes	Yes	Yes	Yes	Yes	Yes	Yes	Yes
Recall Mode	None	None	None	None	None	None	None	C-Min	C-Min	None	C-Min	C-Min
Act Effct Green (s)	20.0	7.5	7.5	24.8	8.4	8.4	81.1	73.6	73.6	82.4	76.0	76.0
Actuated g/C Ratio	0.17	0.06	0.06	0.21	0.07	0.07	0.68	0.61	0.61	0.69	0.63	0.63
v/c Ratio	0.46	0.28	0.11	0.48	0.27	0.68	0.05	0.57	0.08	0.33	0.46	0.03
Control Delay	46.4	59.6	1.2	45.6	57.1	18.9	7.8	16.5	1.3	11.4	9.6	0.1
Queue Delay	0.0	0.0	0.0	0.0	0.0	0.0	0.0	0.0	0.0	0.0	0.0	0.0
Total Delay	46.4	59.6	1.2	45.6	57.1	18.9	7.8	16.5	1.3	11.4	9.6	0.1
LOS	D	E	A	D	E	B	A	B	A	B	A	A
Approach Delay		43.1			33.0			15.8			9.5	
Approach LOS		D			C			B			A	

Intersection Summary

Cycle Length: 120
 Actuated Cycle Length: 120
 Offset: 49 (41%), Referenced to phase 2:SBTL and 6:NBTL, Start of 1st Green
 Natural Cycle: 65
 Control Type: Actuated-Coordinated
 Maximum v/c Ratio: 0.68
 Intersection Signal Delay: 16.2
 Intersection Capacity Utilization 64.7%
 Analysis Period (min) 15
 Intersection LOS: B
 ICU Level of Service C

Splits and Phases: 2: Scottsdale Road & Paradise Lane



2: Scottsdale Road & Paradise Lane

08/18/2022



Movement	EBL	EBT	EBR	WBL	WBT	WBR	NBL	NBT	NBR	SBL	SBT	SBR
Lane Configurations	↖	↑	↗	↖	↑	↗	↖	↑↑↑	↗	↖	↑↑↑	↗
Traffic Volume (veh/h)	112	29	20	146	32	187	13	1638	77	60	1365	28
Future Volume (veh/h)	112	29	20	146	32	187	13	1638	77	60	1365	28
Initial Q (Qb), veh	0	0	0	0	0	0	0	0	0	0	0	0
Ped-Bike Adj(A_pbT)	1.00		1.00	1.00		1.00	1.00		1.00	1.00		1.00
Parking Bus, Adj	1.00	1.00	1.00	1.00	1.00	1.00	1.00	1.00	1.00	1.00	1.00	1.00
Work Zone On Approach		No			No			No			No	
Adj Sat Flow, veh/h/ln	1870	1870	1870	1870	1870	1870	1870	1870	1870	1870	1870	1870
Adj Flow Rate, veh/h	122	32	22	159	35	203	14	1780	84	65	1484	30
Peak Hour Factor	0.92	0.92	0.92	0.92	0.92	0.92	0.92	0.92	0.92	0.92	0.92	0.92
Percent Heavy Veh, %	2	2	2	2	2	2	2	2	2	2	2	2
Cap, veh/h	166	109	92	307	271	230	635	1905	591	533	1629	506
Arrive On Green	0.03	0.06	0.06	0.12	0.15	0.15	0.11	0.12	0.12	0.09	0.11	0.11
Sat Flow, veh/h	1781	1870	1585	1781	1870	1585	1781	5106	1585	1781	5106	1585
Grp Volume(v), veh/h	122	32	22	159	35	203	14	1780	84	65	1484	30
Grp Sat Flow(s),veh/h/ln	1781	1870	1585	1781	1870	1585	1781	1702	1585	1781	1702	1585
Q Serve(g_s), s	0.7	2.0	1.6	3.4	2.0	15.1	0.0	41.5	5.7	0.0	34.5	2.0
Cycle Q Clear(g_c), s	0.7	2.0	1.6	3.4	2.0	15.1	0.0	41.5	5.7	0.0	34.5	2.0
Prop In Lane	1.00		1.00	1.00		1.00	1.00		1.00	1.00		1.00
Lane Grp Cap(c), veh/h	166	109	92	307	271	230	635	1905	591	533	1629	506
V/C Ratio(X)	0.73	0.29	0.24	0.52	0.13	0.88	0.02	0.93	0.14	0.12	0.91	0.06
Avail Cap(c_a), veh/h	316	452	383	307	452	383	635	2000	621	533	2000	621
HCM Platoon Ratio	1.00	1.00	1.00	1.00	1.00	1.00	0.33	0.33	0.33	0.33	0.33	0.33
Upstream Filter(I)	1.00	1.00	1.00	1.00	1.00	1.00	1.00	1.00	1.00	0.45	0.45	0.45
Uniform Delay (d), s/veh	55.2	54.1	54.0	46.7	44.7	50.3	36.2	51.2	35.5	40.2	52.0	37.5
Incr Delay (d2), s/veh	2.3	0.5	0.5	0.7	0.1	7.0	0.0	10.1	0.5	0.0	4.6	0.1
Initial Q Delay(d3),s/veh	0.0	0.0	0.0	0.0	0.0	0.0	0.0	0.0	0.0	0.0	0.0	0.0
%ile BackOfQ(50%),veh/ln	3.7	1.0	0.7	4.3	0.9	6.5	0.4	20.6	2.4	1.7	16.4	0.8
Unsig. Movement Delay, s/veh												
LnGrp Delay(d),s/veh	57.5	54.7	54.4	47.4	44.8	57.3	36.2	61.2	36.0	40.2	56.6	37.6
LnGrp LOS	E	D	D	D	D	E	D	E	D	D	E	D
Approach Vol, veh/h		176			397			1878			1579	
Approach Delay, s/veh		56.6			52.2			59.9			55.5	
Approach LOS		E			D			E			E	
Timer - Assigned Phs	1	2	3	4	5	6	7	8				
Phs Duration (G+Y+Rc), s	42.4	44.3	7.9	25.4	35.9	50.8	18.3	15.0				
Change Period (Y+Rc), s	* 4	6.0	* 4	8.0	* 4	6.0	* 4	8.0				
Max Green Setting (Gmax), s	* 8	47.0	* 14	29.0	* 8	47.0	* 14	29.0				
Max Q Clear Time (g_c+I1), s	2.0	36.5	2.7	17.1	2.0	43.5	5.4	4.0				
Green Ext Time (p_c), s	0.0	1.8	0.1	0.4	0.0	1.3	0.1	0.1				

Intersection Summary

HCM 6th Ctrl Delay	57.3
HCM 6th LOS	E

Notes

- User approved pedestrian interval to be less than phase max green.
- * HCM 6th computational engine requires equal clearance times for the phases crossing the barrier.

3: Scottsdale Road & Driveway A

08/18/2022

Intersection						
Int Delay, s/veh	0					
Movement	EBL	EBR	NBL	NBT	SBT	SBR
Lane Configurations		↗	↘	↑↑↑	↑↑↑	↗
Traffic Vol, veh/h	0	2	2	1719	1547	1
Future Vol, veh/h	0	2	2	1719	1547	1
Conflicting Peds, #/hr	0	0	0	0	0	0
Sign Control	Stop	Stop	Free	Free	Free	Free
RT Channelized	-	None	-	None	-	None
Storage Length	-	0	110	-	-	110
Veh in Median Storage, #	0	-	-	0	0	-
Grade, %	0	-	-	0	0	-
Peak Hour Factor	92	92	92	92	92	92
Heavy Vehicles, %	2	2	2	2	2	2
Mvmt Flow	0	2	2	1868	1682	1

Major/Minor	Minor2	Major1	Major2		
Conflicting Flow All	-	841	1683	0	-
Stage 1	-	-	-	-	-
Stage 2	-	-	-	-	-
Critical Hdwy	-	7.14	5.34	-	-
Critical Hdwy Stg 1	-	-	-	-	-
Critical Hdwy Stg 2	-	-	-	-	-
Follow-up Hdwy	-	3.92	3.12	-	-
Pot Cap-1 Maneuver	0	*567	*713	-	-
Stage 1	0	-	-	-	-
Stage 2	0	-	-	-	-
Platoon blocked, %		1	1	-	-
Mov Cap-1 Maneuver	-	*567	*713	-	-
Mov Cap-2 Maneuver	-	-	-	-	-
Stage 1	-	-	-	-	-
Stage 2	-	-	-	-	-

Approach	EB	NB	SB
HCM Control Delay, s	11.4	0	0
HCM LOS	B		

Minor Lane/Major Mvmt	NBL	NBT	EBLn1	SBT	SBR
Capacity (veh/h)	* 713	-	567	-	-
HCM Lane V/C Ratio	0.003	-	0.004	-	-
HCM Control Delay (s)	10.1	-	11.4	-	-
HCM Lane LOS	B	-	B	-	-
HCM 95th %tile Q(veh)	0	-	0	-	-

Notes
 ~: Volume exceeds capacity \$: Delay exceeds 300s +: Computation Not Defined *: All major volume in platoon

Intersection												
Int Delay, s/veh	1.3											
Movement	EBL	EBT	EBR	WBL	WBT	WBR	NBL	NBT	NBR	SBL	SBT	SBR
Lane Configurations	↵	↵		↵	↵	↵	↵	↵↵↵	↵	↵	↵↵↵	↵
Traffic Vol, veh/h	11	2	35	15	1	135	34	1587	50	78	1463	13
Future Vol, veh/h	11	2	35	15	1	135	34	1587	50	78	1463	13
Conflicting Peds, #/hr	0	0	0	0	0	0	0	0	0	0	0	0
Sign Control	Stop	Stop	Stop	Stop	Stop	Stop	Free	Free	Free	Free	Free	Free
RT Channelized	-	-	None	-	-	None	-	-	None	-	-	None
Storage Length	100	-	-	80	-	115	200	-	205	195	-	100
Veh in Median Storage, #	-	0	-	-	0	-	-	0	-	-	0	-
Grade, %	-	0	-	-	0	-	-	0	-	-	0	-
Peak Hour Factor	92	92	92	92	92	92	92	92	92	92	92	92
Heavy Vehicles, %	2	2	2	2	2	2	2	2	2	2	2	2
Mvmt Flow	12	2	38	16	1	147	37	1725	54	85	1590	14

Major/Minor	Minor2		Minor1		Major1			Major2				
Conflicting Flow All	2525	3613	795	2606	3573	863	1604	0	0	1779	0	0
Stage 1	1760	1760	-	1799	1799	-	-	-	-	-	-	-
Stage 2	765	1853	-	807	1774	-	-	-	-	-	-	-
Critical Hdwy	6.44	6.54	7.14	6.44	6.54	7.14	5.34	-	-	5.34	-	-
Critical Hdwy Stg 1	7.34	5.54	-	7.34	5.54	-	-	-	-	-	-	-
Critical Hdwy Stg 2	6.74	5.54	-	6.74	5.54	-	-	-	-	-	-	-
Follow-up Hdwy	3.82	4.02	3.92	3.82	4.02	3.92	3.12	-	-	3.12	-	-
Pot Cap-1 Maneuver	*222	80	*588	*222	*100	*545	*740	-	-	*686	-	-
Stage 1	*426	457	-	*560	*532	-	-	-	-	-	-	-
Stage 2	*560	508	-	*604	*447	-	-	-	-	-	-	-
Platoon blocked, %	1	1	1	1	1	1	1	-	-	1	-	-
Mov Cap-1 Maneuver	*140	67	*588	*177	*84	*545	*740	-	-	*686	-	-
Mov Cap-2 Maneuver	*140	67	-	*177	*84	-	-	-	-	-	-	-
Stage 1	*405	400	-	*532	*506	-	-	-	-	-	-	-
Stage 2	*388	482	-	*492	*392	-	-	-	-	-	-	-

Approach	EB		WB		NB			SB		
HCM Control Delay, s	18.8		15.6		0.2			0.6		
HCM LOS	C		C							

Minor Lane/Major Mvmt	NBL	NBT	NBR	EBLn1	EBLn2	WBLn1	WBLn2	WBLn3	SBL	SBT	SBR
Capacity (veh/h)	*740	-	-	140	414	177	84	545	*686	-	-
HCM Lane V/C Ratio	0.05	-	-	0.085	0.097	0.092	0.013	0.269	0.124	-	-
HCM Control Delay (s)	10.1	-	-	33.1	14.6	27.4	48.4	14	11	-	-
HCM Lane LOS	B	-	-	D	B	D	E	B	B	-	-
HCM 95th %tile Q(veh)	0.2	-	-	0.3	0.3	0.3	0	1.1	0.4	-	-

Notes
 ~: Volume exceeds capacity \$: Delay exceeds 300s +: Computation Not Defined *: All major volume in platoon

5: Scottsdale Road & Kierland Boulevard/Greenway Hayden Loop

08/18/2022



Movement	EBL	EBT	EBR	WBL	WBT	WBR	NBL	NBT	NBR	SBL	SBT	SBR
Lane Configurations	↔↔	↑↑	↗	↔↔	↑↑↔		↔↔	↑↑↑	↗	↔↔	↑↑↑	↗
Traffic Volume (veh/h)	185	206	84	410	397	151	128	1296	305	232	1025	240
Future Volume (veh/h)	185	206	84	410	397	151	128	1296	305	232	1025	240
Initial Q (Qb), veh	0	0	0	0	0	0	0	0	0	0	0	0
Ped-Bike Adj(A_pbT)	1.00		1.00	1.00		1.00	1.00		1.00	1.00		1.00
Parking Bus, Adj	1.00	1.00	1.00	1.00	1.00	1.00	1.00	1.00	1.00	1.00	1.00	1.00
Work Zone On Approach		No			No			No			No	
Adj Sat Flow, veh/h/ln	1870	1870	1870	1870	1870	1870	1870	1870	1870	1870	1870	1870
Adj Flow Rate, veh/h	201	224	91	446	432	164	139	1409	332	252	1114	261
Peak Hour Factor	0.92	0.92	0.92	0.92	0.92	0.92	0.92	0.92	0.92	0.92	0.92	0.92
Percent Heavy Veh, %	2	2	2	2	2	2	2	2	2	2	2	2
Cap, veh/h	285	306	137	507	552	201	1124	1506	467	972	1281	398
Arrive On Green	0.08	0.09	0.09	0.05	0.05	0.05	0.65	0.59	0.59	0.56	0.50	0.50
Sat Flow, veh/h	3456	3554	1585	3456	3690	1342	3456	5106	1585	3456	5106	1585
Grp Volume(v), veh/h	201	224	91	446	397	199	139	1409	332	252	1114	261
Grp Sat Flow(s),veh/h/ln	1728	1777	1585	1728	1702	1629	1728	1702	1585	1728	1702	1585
Q Serve(g_s), s	6.8	7.4	3.6	15.4	13.8	14.5	1.8	30.3	11.7	4.5	23.1	14.7
Cycle Q Clear(g_c), s	6.8	7.4	3.6	15.4	13.8	14.5	1.8	30.3	11.7	4.5	23.1	14.7
Prop In Lane	1.00		1.00	1.00		0.82	1.00		1.00	1.00		1.00
Lane Grp Cap(c), veh/h	285	306	137	507	509	244	1124	1506	467	972	1281	398
V/C Ratio(X)	0.71	0.73	0.67	0.88	0.78	0.82	0.12	0.94	0.71	0.26	0.87	0.66
Avail Cap(c_a), veh/h	711	841	375	559	661	316	1124	1587	493	972	1757	546
HCM Platoon Ratio	1.00	1.00	1.00	0.33	0.33	0.33	2.00	2.00	2.00	2.00	2.00	2.00
Upstream Filter(I)	1.00	1.00	1.00	0.93	0.93	0.93	0.75	0.75	0.75	1.00	1.00	1.00
Uniform Delay (d), s/veh	53.6	53.5	15.4	56.0	55.1	55.4	14.5	23.6	9.1	19.8	28.1	26.0
Incr Delay (d2), s/veh	1.2	1.3	2.1	12.3	3.0	8.8	0.0	9.8	6.7	0.1	8.2	8.2
Initial Q Delay(d3),s/veh	0.0	0.0	0.0	0.0	0.0	0.0	0.0	0.0	0.0	0.0	0.0	0.0
%ile BackOfQ(50%),veh/ln	3.0	3.3	2.6	8.0	6.5	6.9	0.7	8.2	3.6	1.6	7.2	5.2
Unsig. Movement Delay, s/veh												
LnGrp Delay(d),s/veh	54.8	54.8	17.5	68.3	58.1	64.2	14.5	33.3	15.8	19.9	36.4	34.2
LnGrp LOS	D	D	B	E	E	E	B	C	B	B	D	C
Approach Vol, veh/h		516			1042			1880			1627	
Approach Delay, s/veh		48.2			63.6			28.8			33.5	
Approach LOS		D			E			C			C	
Timer - Assigned Phs	1	2	3	4	5	6	7	8				
Phs Duration (G+Y+Rc), s	45.0	35.8	15.5	23.7	39.8	41.1	23.2	15.9				
Change Period (Y+Rc), s	6.0	5.7	* 5.6	* 5.7	6.0	5.7	5.6	* 5.6				
Max Green Setting (Gmax), s	8.0	41.3	* 25	* 23	12.0	37.3	19.4	* 28				
Max Q Clear Time (g_c+I1), s	3.8	25.1	8.8	16.5	6.5	32.3	17.4	9.4				
Green Ext Time (p_c), s	0.1	5.0	0.3	1.4	0.2	3.1	0.2	1.0				

Intersection Summary

HCM 6th Ctrl Delay	39.5
HCM 6th LOS	D

Notes

User approved pedestrian interval to be less than phase max green.
 * HCM 6th computational engine requires equal clearance times for the phases crossing the barrier.

6: Scottsdale Road & Greenway Parkway/Butherus Drive

08/18/2022

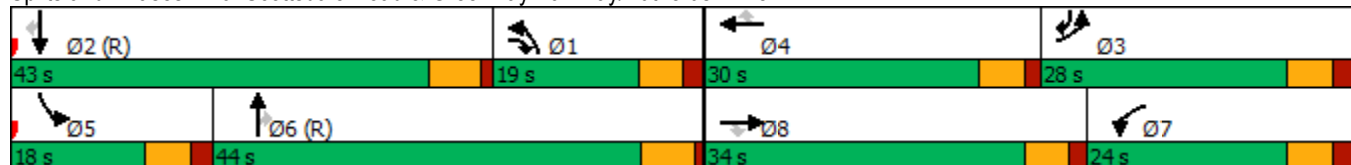


Lane Group	EBL	EBT	EBR	WBL	WBT	WBR	NBL	NBT	NBR	SBL	SBT	SBR
Lane Configurations	↔↔	↕↕	↔	↔↔	↕↕	↔	↔↔	↕↕↕	↔	↔↔	↕↕↕	↔
Traffic Volume (vph)	256	222	204	333	444	238	461	1260	262	111	1199	183
Future Volume (vph)	256	222	204	333	444	238	461	1260	262	111	1199	183
Turn Type	Prot	NA	pm+ov	Prot	NA	Perm	Prot	NA	Perm	Prot	NA	pm+ov
Protected Phases	3	8	1	7	4		1	6		5	2	3
Permitted Phases			8			4			6			2
Detector Phase	3	8	1	7	4	4	1	6	6	5	2	3
Switch Phase												
Minimum Initial (s)	5.0	7.0	5.0	5.0	7.0	7.0	5.0	10.0	10.0	5.0	10.0	5.0
Minimum Split (s)	11.0	13.2	11.0	11.0	13.2	13.2	11.0	16.0	16.0	11.0	16.0	11.0
Total Split (s)	28.0	34.0	19.0	24.0	30.0	30.0	19.0	44.0	44.0	18.0	43.0	28.0
Total Split (%)	23.3%	28.3%	15.8%	20.0%	25.0%	25.0%	15.8%	36.7%	36.7%	15.0%	35.8%	23.3%
Yellow Time (s)	4.0	4.0	4.0	4.0	4.0	4.0	4.0	4.7	4.7	4.0	4.7	4.0
All-Red Time (s)	2.0	1.5	2.0	2.0	1.5	1.5	2.0	1.0	1.0	2.0	1.0	2.0
Lost Time Adjust (s)	0.0	0.0	0.0	0.0	0.0	0.0	0.0	0.0	0.0	0.0	0.0	0.0
Total Lost Time (s)	6.0	5.5	6.0	6.0	5.5	5.5	6.0	5.7	5.7	6.0	5.7	6.0
Lead/Lag	Lag	Lead	Lag	Lag	Lead	Lead	Lag	Lag	Lag	Lead	Lead	Lag
Lead-Lag Optimize?	Yes	Yes	Yes	Yes	Yes	Yes	Yes	Yes	Yes	Yes	Yes	Yes
Recall Mode	None	None	None	None	None	None	None	C-Min	C-Min	None	C-Min	None
Act Effct Green (s)	14.1	15.1	38.7	19.7	20.7	20.7	18.1	53.4	53.4	8.6	43.9	63.6
Actuated g/C Ratio	0.12	0.13	0.32	0.16	0.17	0.17	0.15	0.44	0.44	0.07	0.37	0.53
v/c Ratio	0.69	0.73	0.26	0.64	0.79	0.60	0.97	0.61	0.37	0.49	0.70	0.23
Control Delay	59.9	55.0	7.1	52.1	57.3	18.7	83.3	28.1	14.5	75.8	18.0	3.1
Queue Delay	0.0	0.0	0.0	0.0	0.0	0.0	0.0	0.0	0.0	0.0	0.0	0.0
Total Delay	59.9	55.0	7.1	52.1	57.3	18.7	83.3	28.1	14.5	75.8	18.0	3.1
LOS	E	D	A	D	E	B	F	C	B	E	B	A
Approach Delay		47.6			46.6			39.1			20.5	
Approach LOS		D			D			D			C	

Intersection Summary

Cycle Length: 120
 Actuated Cycle Length: 120
 Offset: 97 (81%), Referenced to phase 2:SBT and 6:NBT, Start of 1st Green
 Natural Cycle: 75
 Control Type: Actuated-Coordinated
 Maximum v/c Ratio: 0.97
 Intersection Signal Delay: 36.3
 Intersection LOS: D
 Intersection Capacity Utilization 75.2%
 ICU Level of Service D
 Analysis Period (min) 15

Splits and Phases: 6: Scottsdale Road & Greenway Parkway/Butherus Drive



6: Scottsdale Road & Greenway Parkway/Butherus Drive

08/18/2022



Movement	EBL	EBT	EBR	WBL	WBT	WBR	NBL	NBT	NBR	SBL	SBT	SBR
Lane Configurations	↔↔	↕↔	↔↔	↔↔	↕↕	↔↔	↔↔	↕↕↕	↔↔	↔↔	↕↕↕	↔↔
Traffic Volume (veh/h)	256	222	204	333	444	238	461	1260	262	111	1199	183
Future Volume (veh/h)	256	222	204	333	444	238	461	1260	262	111	1199	183
Initial Q (Qb), veh	0	0	0	0	0	0	0	0	0	0	0	0
Ped-Bike Adj(A_pbT)	1.00		1.00	1.00		1.00	1.00		1.00	1.00		1.00
Parking Bus, Adj	1.00	1.00	1.00	1.00	1.00	1.00	1.00	1.00	1.00	1.00	1.00	1.00
Work Zone On Approach		No			No			No			No	
Adj Sat Flow, veh/h/ln	1870	1870	1870	1870	1870	1870	1870	1870	1870	1870	1870	1870
Adj Flow Rate, veh/h	278	343	154	362	483	259	501	1370	0	121	1303	199
Peak Hour Factor	0.92	0.92	0.92	0.92	0.92	0.92	0.92	0.92	0.92	0.92	0.92	0.92
Percent Heavy Veh, %	2	2	2	2	2	2	2	2	2	2	2	2
Cap, veh/h	343	439	610	494	583	260	924	2520		174	1424	595
Arrive On Green	0.10	0.12	0.12	0.14	0.16	0.16	0.27	0.49	0.00	0.10	0.56	0.56
Sat Flow, veh/h	3563	3741	1585	3456	3554	1585	3456	5106	1585	3456	5106	1585
Grp Volume(v), veh/h	278	343	154	362	483	259	501	1370	0	121	1303	199
Grp Sat Flow(s),veh/h/ln	1781	1870	1585	1728	1777	1585	1728	1702	1585	1728	1702	1585
Q Serve(g_s), s	9.2	10.7	0.0	12.0	15.8	16.2	14.9	22.3	0.0	4.1	27.7	0.0
Cycle Q Clear(g_c), s	9.2	10.7	0.0	12.0	15.8	16.2	14.9	22.3	0.0	4.1	27.7	0.0
Prop In Lane	1.00		1.00	1.00		1.00	1.00		1.00	1.00		1.00
Lane Grp Cap(c), veh/h	343	439	610	494	583	260	924	2520		174	1424	595
V/C Ratio(X)	0.81	0.78	0.25	0.73	0.83	1.00	0.54	0.54		0.70	0.91	0.33
Avail Cap(c_a), veh/h	653	888	800	518	726	324	924	2520		346	1587	645
HCM Platoon Ratio	1.00	1.00	1.00	1.00	1.00	1.00	1.00	1.00	1.00	2.00	2.00	2.00
Upstream Filter(I)	1.00	1.00	1.00	1.00	1.00	1.00	1.00	1.00	0.00	0.76	0.76	0.76
Uniform Delay (d), s/veh	53.2	51.5	25.2	49.2	48.5	34.1	37.7	21.0	0.0	53.1	25.2	15.6
Incr Delay (d2), s/veh	1.8	1.2	0.1	4.3	5.4	43.5	0.4	0.8	0.0	1.4	8.5	1.2
Initial Q Delay(d3),s/veh	0.0	0.0	0.0	0.0	0.0	0.0	0.0	0.0	0.0	0.0	0.0	0.0
%ile BackOfQ(50%),veh/ln	4.1	5.0	2.9	5.4	7.4	9.2	6.2	8.5	0.0	1.7	7.9	2.5
Unsig. Movement Delay, s/veh												
LnGrp Delay(d),s/veh	54.9	52.6	25.2	53.5	53.9	77.6	38.0	21.9	0.0	54.5	33.7	16.7
LnGrp LOS	D	D	C	D	D	E	D	C		D	C	B
Approach Vol, veh/h		775			1104			1871			1623	
Approach Delay, s/veh		48.0			59.3			26.2			33.2	
Approach LOS		D			E			C			C	
Timer - Assigned Phs	1	2	3	4	5	6	7	8				
Phs Duration (G+Y+Rc), s	38.1	39.2	17.5	25.2	12.0	65.2	23.2	19.6				
Change Period (Y+Rc), s	6.0	5.7	6.0	5.5	6.0	* 6	6.0	5.5				
Max Green Setting (Gmax), s	13.0	37.3	22.0	24.5	12.0	* 38	18.0	28.5				
Max Q Clear Time (g_c+I1), s	16.9	29.7	11.2	18.2	6.1	24.3	14.0	12.7				
Green Ext Time (p_c), s	0.0	3.8	0.4	1.5	0.1	5.4	0.3	1.4				

Intersection Summary

HCM 6th Ctrl Delay	38.3
HCM 6th LOS	D

Notes

- User approved pedestrian interval to be less than phase max green.
- User approved volume balancing among the lanes for turning movement.
- * HCM 6th computational engine requires equal clearance times for the phases crossing the barrier.

Intersection						
Int Delay, s/veh	4.3					
Movement	EBL	EBT	WBT	WBR	SBL	SBR
Lane Configurations						
Traffic Vol, veh/h	59	99	218	56	41	144
Future Vol, veh/h	59	99	218	56	41	144
Conflicting Peds, #/hr	0	0	0	0	0	0
Sign Control	Free	Free	Free	Free	Stop	Stop
RT Channelized	-	None	-	None	-	None
Storage Length	100	-	-	-	0	-
Veh in Median Storage, #	-	0	0	-	0	-
Grade, %	-	0	0	-	0	-
Peak Hour Factor	92	92	92	92	92	92
Heavy Vehicles, %	2	2	2	2	2	2
Mvmt Flow	64	108	237	61	45	157
Major/Minor	Major1	Major2	Minor2			
Conflicting Flow All	298	0	-	0	504	268
Stage 1	-	-	-	-	268	-
Stage 2	-	-	-	-	236	-
Critical Hdwy	4.12	-	-	-	6.42	6.22
Critical Hdwy Stg 1	-	-	-	-	5.42	-
Critical Hdwy Stg 2	-	-	-	-	5.42	-
Follow-up Hdwy	2.218	-	-	-	3.518	3.318
Pot Cap-1 Maneuver	1263	-	-	-	538	771
Stage 1	-	-	-	-	777	-
Stage 2	-	-	-	-	818	-
Platoon blocked, %		-	-	-	1	
Mov Cap-1 Maneuver	1263	-	-	-	510	771
Mov Cap-2 Maneuver	-	-	-	-	585	-
Stage 1	-	-	-	-	737	-
Stage 2	-	-	-	-	818	-
Approach	EB	WB	SB			
HCM Control Delay, s	3	0	11.9			
HCM LOS						B
Minor Lane/Major Mvmt	EBL	EBT	WBT	WBR	SBLn1	
Capacity (veh/h)	1263	-	-	-	720	
HCM Lane V/C Ratio	0.051	-	-	-	0.279	
HCM Control Delay (s)	8	-	-	-	11.9	
HCM Lane LOS	A	-	-	-	B	
HCM 95th %tile Q(veh)	0.2	-	-	-	1.1	

Intersection						
Int Delay, s/veh	3.1					
Movement	EBT	EBR	WBL	WBT	NBL	NBR
Lane Configurations						
Traffic Vol, veh/h	104	77	40	198	77	48
Future Vol, veh/h	104	77	40	198	77	48
Conflicting Peds, #/hr	0	0	0	0	0	0
Sign Control	Free	Free	Free	Free	Stop	Stop
RT Channelized	-	None	-	None	-	None
Storage Length	-	-	100	-	80	0
Veh in Median Storage, #	0	-	-	0	0	-
Grade, %	0	-	-	0	0	-
Peak Hour Factor	92	92	92	92	92	92
Heavy Vehicles, %	2	2	2	2	2	2
Mvmt Flow	113	84	43	215	84	52
Major/Minor	Major1	Major2	Minor1			
Conflicting Flow All	0	0	197	0	456	155
Stage 1	-	-	-	-	155	-
Stage 2	-	-	-	-	301	-
Critical Hdwy	-	-	4.12	-	6.42	6.22
Critical Hdwy Stg 1	-	-	-	-	5.42	-
Critical Hdwy Stg 2	-	-	-	-	5.42	-
Follow-up Hdwy	-	-	2.218	-	3.518	3.318
Pot Cap-1 Maneuver	-	-	1385	-	576	929
Stage 1	-	-	-	-	894	-
Stage 2	-	-	-	-	751	-
Platoon blocked, %	-	-	1	-	1	1
Mov Cap-1 Maneuver	-	-	1385	-	558	929
Mov Cap-2 Maneuver	-	-	-	-	612	-
Stage 1	-	-	-	-	894	-
Stage 2	-	-	-	-	728	-
Approach	EB	WB	NB			
HCM Control Delay, s	0	1.3	10.8			
HCM LOS			B			
Minor Lane/Major Mvmt	NBLn1	NBLn2	EBT	EBR	WBL	WBT
Capacity (veh/h)	612	929	-	-	1385	-
HCM Lane V/C Ratio	0.137	0.056	-	-	0.031	-
HCM Control Delay (s)	11.8	9.1	-	-	7.7	-
HCM Lane LOS	B	A	-	-	A	-
HCM 95th %tile Q(veh)	0.5	0.2	-	-	0.1	-

Intersection

Int Delay, s/veh 2.1

Movement	WBL	WBR	NBT	NBR	SBL	SBT
Lane Configurations						
Traffic Vol, veh/h	26	26	93	7	1	84
Future Vol, veh/h	26	26	93	7	1	84
Conflicting Peds, #/hr	0	0	0	0	0	0
Sign Control	Stop	Stop	Free	Free	Free	Free
RT Channelized	-	None	-	None	-	None
Storage Length	75	0	-	-	100	-
Veh in Median Storage, #	0	-	0	-	-	0
Grade, %	0	-	0	-	-	0
Peak Hour Factor	92	92	92	92	92	92
Heavy Vehicles, %	2	2	2	2	2	2
Mvmt Flow	28	28	101	8	1	91

Major/Minor	Minor1	Major1	Major2
Conflicting Flow All	198	105	0
Stage 1	105	-	-
Stage 2	93	-	-
Critical Hdwy	6.42	6.22	-
Critical Hdwy Stg 1	5.42	-	-
Critical Hdwy Stg 2	5.42	-	-
Follow-up Hdwy	3.518	3.318	-
Pot Cap-1 Maneuver	791	949	-
Stage 1	919	-	-
Stage 2	931	-	-
Platoon blocked, %			
Mov Cap-1 Maneuver	790	949	-
Mov Cap-2 Maneuver	782	-	-
Stage 1	919	-	-
Stage 2	930	-	-

Approach	WB	NB	SB
HCM Control Delay, s	9.4	0	0.1
HCM LOS	A		

Minor Lane/Major Mvmt	NBT	NBRWBLn1	WBLn2	SBL	SBT
Capacity (veh/h)	-	-	782	949	1481
HCM Lane V/C Ratio	-	-	0.036	0.03	0.001
HCM Control Delay (s)	-	-	9.8	8.9	7.4
HCM Lane LOS	-	-	A	A	A
HCM 95th %tile Q(veh)	-	-	0.1	0.1	0

Intersection												
Int Delay, s/veh	0.1											
Movement	EBL	EBT	EBR	WBL	WBT	WBR	NBL	NBT	NBR	SBL	SBT	SBR
Lane Configurations		↕			↕		↕	↕		↕	↕	
Traffic Vol, veh/h	0	0	0	0	0	2	0	94	2	2	105	0
Future Vol, veh/h	0	0	0	0	0	2	0	94	2	2	105	0
Conflicting Peds, #/hr	0	0	0	0	0	0	0	0	0	0	0	0
Sign Control	Stop	Stop	Stop	Stop	Stop	Stop	Free	Free	Free	Free	Free	Free
RT Channelized	-	-	None	-	-	None	-	-	None	-	-	None
Storage Length	-	-	-	-	-	-	100	-	-	100	-	-
Veh in Median Storage, #	-	0	-	-	0	-	-	0	-	-	0	-
Grade, %	-	0	-	-	0	-	-	0	-	-	0	-
Peak Hour Factor	92	92	92	92	92	92	92	92	92	92	92	92
Heavy Vehicles, %	2	2	2	2	2	2	2	2	2	2	2	2
Mvmt Flow	0	0	0	0	0	2	0	102	2	2	114	0

Major/Minor	Minor2		Minor1		Major1			Major2				
Conflicting Flow All	222	222	114	221	221	103	114	0	0	104	0	0
Stage 1	118	118	-	103	103	-	-	-	-	-	-	-
Stage 2	104	104	-	118	118	-	-	-	-	-	-	-
Critical Hdwy	7.12	6.52	6.22	7.12	6.52	6.22	4.12	-	-	4.12	-	-
Critical Hdwy Stg 1	6.12	5.52	-	6.12	5.52	-	-	-	-	-	-	-
Critical Hdwy Stg 2	6.12	5.52	-	6.12	5.52	-	-	-	-	-	-	-
Follow-up Hdwy	3.518	4.018	3.318	3.518	4.018	3.318	2.218	-	-	2.218	-	-
Pot Cap-1 Maneuver	734	677	939	735	678	952	1475	-	-	1488	-	-
Stage 1	887	798	-	903	810	-	-	-	-	-	-	-
Stage 2	902	809	-	887	798	-	-	-	-	-	-	-
Platoon blocked, %								-	-	-	-	-
Mov Cap-1 Maneuver	732	676	939	734	677	952	1475	-	-	1488	-	-
Mov Cap-2 Maneuver	732	676	-	734	677	-	-	-	-	-	-	-
Stage 1	887	797	-	903	810	-	-	-	-	-	-	-
Stage 2	900	809	-	886	797	-	-	-	-	-	-	-

Approach	EB		WB		NB		SB	
HCM Control Delay, s	0		8.8		0		0.1	
HCM LOS	A		A					

Minor Lane/Major Mvmt	NBL	NBT	NBR	EBLn1WBLn1	SBL	SBT	SBR
Capacity (veh/h)	1475	-	-	-	952	1488	-
HCM Lane V/C Ratio	-	-	-	-	0.002	0.001	-
HCM Control Delay (s)	0	-	-	0	8.8	7.4	-
HCM Lane LOS	A	-	-	A	A	A	-
HCM 95th %tile Q(veh)	0	-	-	-	0	0	-

Intersection												
Int Delay, s/veh	1.2											
Movement	EBL	EBT	EBR	WBL	WBT	WBR	NBL	NBT	NBR	SBL	SBT	SBR
Lane Configurations	↶	↷		↶	↷			↕			↕	
Traffic Vol, veh/h	0	129	12	18	159	0	9	0	18	0	0	0
Future Vol, veh/h	0	129	12	18	159	0	9	0	18	0	0	0
Conflicting Peds, #/hr	0	0	0	0	0	0	0	0	0	0	0	0
Sign Control	Free	Free	Free	Free	Free	Free	Stop	Stop	Stop	Stop	Stop	Stop
RT Channelized	-	-	None	-	-	None	-	-	None	-	-	None
Storage Length	100	-	-	100	-	-	-	-	-	-	-	-
Veh in Median Storage, #	-	0	-	-	0	-	-	0	-	-	0	-
Grade, %	-	0	-	-	0	-	-	0	-	-	0	-
Peak Hour Factor	92	92	92	92	92	92	92	92	92	92	92	92
Heavy Vehicles, %	2	2	2	2	2	2	2	2	2	2	2	2
Mvmt Flow	0	140	13	20	173	0	10	0	20	0	0	0

Major/Minor	Major1			Major2			Minor1			Minor2		
Conflicting Flow All	173	0	0	153	0	0	360	360	147	370	366	173
Stage 1	-	-	-	-	-	-	147	147	-	213	213	-
Stage 2	-	-	-	-	-	-	213	213	-	157	153	-
Critical Hdwy	4.12	-	-	4.12	-	-	7.12	6.52	6.22	7.12	6.52	6.22
Critical Hdwy Stg 1	-	-	-	-	-	-	6.12	5.52	-	6.12	5.52	-
Critical Hdwy Stg 2	-	-	-	-	-	-	6.12	5.52	-	6.12	5.52	-
Follow-up Hdwy	2.218	-	-	2.218	-	-	3.518	4.018	3.318	3.518	4.018	3.318
Pot Cap-1 Maneuver	1404	-	-	1428	-	-	596	567	900	587	562	871
Stage 1	-	-	-	-	-	-	856	775	-	789	726	-
Stage 2	-	-	-	-	-	-	789	726	-	845	771	-
Platoon blocked, %	-	-	-	-	-	-	-	-	-	-	-	-
Mov Cap-1 Maneuver	1404	-	-	1428	-	-	589	559	900	568	554	871
Mov Cap-2 Maneuver	-	-	-	-	-	-	589	559	-	568	554	-
Stage 1	-	-	-	-	-	-	856	775	-	789	716	-
Stage 2	-	-	-	-	-	-	778	716	-	827	771	-

Approach	EB			WB			NB			SB		
HCM Control Delay, s	0			0.8			9.9			0		
HCM LOS							A			A		

Minor Lane/Major Mvmt	NBLn1	EBL	EBT	EBR	WBL	WBT	WBR	SBLn1
Capacity (veh/h)	765	1404	-	-	1428	-	-	-
HCM Lane V/C Ratio	0.038	-	-	-	0.014	-	-	-
HCM Control Delay (s)	9.9	0	-	-	7.6	-	-	0
HCM Lane LOS	A	A	-	-	A	-	-	A
HCM 95th %tile Q(veh)	0.1	0	-	-	0	-	-	-

Intersection	
Intersection Delay, s/veh	8.9
Intersection LOS	A

Movement	EBL	EBT	EBR	WBL	WBT	WBR	NBL	NBT	NBR	SBL	SBT	SBR
Lane Configurations	↶	↷		↶	↷		↶	↷		↶	↷	
Traffic Vol, veh/h	21	56	46	43	66	4	56	71	18	9	71	32
Future Vol, veh/h	21	56	46	43	66	4	56	71	18	9	71	32
Peak Hour Factor	0.92	0.92	0.92	0.92	0.92	0.92	0.92	0.92	0.92	0.92	0.92	0.92
Heavy Vehicles, %	2	2	2	2	2	2	2	2	2	2	2	2
Mvmt Flow	23	61	50	47	72	4	61	77	20	10	77	35
Number of Lanes	1	1	0	1	1	0	1	1	0	1	1	0

Approach	EB	WB	NB	SB
Opposing Approach	WB	EB	SB	NB
Opposing Lanes	2	2	2	2
Conflicting Approach Left	SB	NB	EB	WB
Conflicting Lanes Left	2	2	2	2
Conflicting Approach Right	NB	SB	WB	EB
Conflicting Lanes Right	2	2	2	2
HCM Control Delay	8.8	8.9	9	8.9
HCM LOS	A	A	A	A

Lane	NBLn1	NBLn2	EBLn1	EBLn2	WBLn1	WBLn2	SBLn1	SBLn2
Vol Left, %	100%	0%	100%	0%	100%	0%	100%	0%
Vol Thru, %	0%	80%	0%	55%	0%	94%	0%	69%
Vol Right, %	0%	20%	0%	45%	0%	6%	0%	31%
Sign Control	Stop	Stop	Stop	Stop	Stop	Stop	Stop	Stop
Traffic Vol by Lane	56	89	21	102	43	70	9	103
LT Vol	56	0	21	0	43	0	9	0
Through Vol	0	71	0	56	0	66	0	71
RT Vol	0	18	0	46	0	4	0	32
Lane Flow Rate	61	97	23	111	47	76	10	112
Geometry Grp	7	7	7	7	7	7	7	7
Degree of Util (X)	0.099	0.139	0.037	0.156	0.077	0.113	0.016	0.16
Departure Headway (Hd)	5.831	5.186	5.899	5.078	5.901	5.357	5.88	5.158
Convergence, Y/N	Yes	Yes	Yes	Yes	Yes	Yes	Yes	Yes
Cap	614	690	606	704	606	667	607	693
Service Time	3.578	2.932	3.648	2.827	3.651	3.107	3.629	2.907
HCM Lane V/C Ratio	0.099	0.141	0.038	0.158	0.078	0.114	0.016	0.162
HCM Control Delay	9.2	8.8	8.9	8.8	9.1	8.8	8.7	8.9
HCM Lane LOS	A	A	A	A	A	A	A	A
HCM 95th-tile Q	0.3	0.5	0.1	0.6	0.2	0.4	0	0.6

15: 73rd Street/Dial Boulevard & Greenway Hayden Loop

08/18/2022



Lane Group	EBL	EBT	WBL	WBT	WBR	NBL	NBT	NBR	SBL	SBT	SBR
Lane Configurations											
Traffic Volume (vph)	99	549	206	787	45	106	93	383	51	81	105
Future Volume (vph)	99	549	206	787	45	106	93	383	51	81	105
Turn Type	pm+pt	NA	pm+pt	NA	Perm	Perm	NA	Perm	Perm	NA	Perm
Protected Phases	3	8	7	4			6			2	
Permitted Phases	8		4		4	6		6	2		2
Detector Phase	3	8	7	4	4	6	6	6	2	2	2
Switch Phase											
Minimum Initial (s)	5.0	10.0	5.0	10.0	10.0	7.0	7.0	7.0	7.0	7.0	7.0
Minimum Split (s)	12.0	37.0	37.0	36.0	36.0	37.0	37.0	37.0	37.0	37.0	37.0
Total Split (s)	14.0	66.0	14.0	66.0	66.0	40.0	40.0	40.0	40.0	40.0	40.0
Total Split (%)	11.7%	55.0%	11.7%	55.0%	55.0%	33.3%	33.3%	33.3%	33.3%	33.3%	33.3%
Yellow Time (s)	3.6	4.4	3.6	4.4	4.4	3.6	3.6	3.6	3.6	3.6	3.6
All-Red Time (s)	1.7	1.0	1.7	1.0	1.0	1.6	1.6	1.6	1.6	1.6	1.6
Lost Time Adjust (s)	0.0	0.0	0.0	0.0	0.0	0.0	0.0	0.0	0.0	0.0	0.0
Total Lost Time (s)	5.3	5.4	5.3	5.4	5.4	5.2	5.2	5.2	5.2	5.2	5.2
Lead/Lag	Lag	Lead	Lag	Lead	Lead						
Lead-Lag Optimize?	Yes	Yes	Yes	Yes	Yes						
Recall Mode	None	C-Min	None	C-Min	C-Min	None	None	None	None	None	None
Act Effct Green (s)	81.7	75.8	92.3	81.8	81.8	16.5	16.5	16.5	16.5	16.5	16.5
Actuated g/C Ratio	0.68	0.63	0.77	0.68	0.68	0.14	0.14	0.14	0.14	0.14	0.14
v/c Ratio	0.25	0.21	0.34	0.35	0.04	0.65	0.40	0.81	0.33	0.35	0.36
Control Delay	9.3	7.0	3.9	10.5	1.6	64.3	49.7	23.1	49.3	48.3	10.5
Queue Delay	0.0	0.0	0.0	0.0	0.0	0.0	0.0	0.0	0.0	0.0	0.0
Total Delay	9.3	7.0	3.9	10.5	1.6	64.3	49.7	23.1	49.3	48.3	10.5
LOS	A	A	A	B	A	E	D	C	D	D	B
Approach Delay		7.3		8.8			34.8			31.8	
Approach LOS		A		A			C			C	

Intersection Summary

Cycle Length: 120

Actuated Cycle Length: 120

Offset: 111 (93%), Referenced to phase 4:WBTL and 8:EBTL, Start of Green

Natural Cycle: 115

Control Type: Actuated-Coordinated

Maximum v/c Ratio: 0.81

Intersection Signal Delay: 16.4

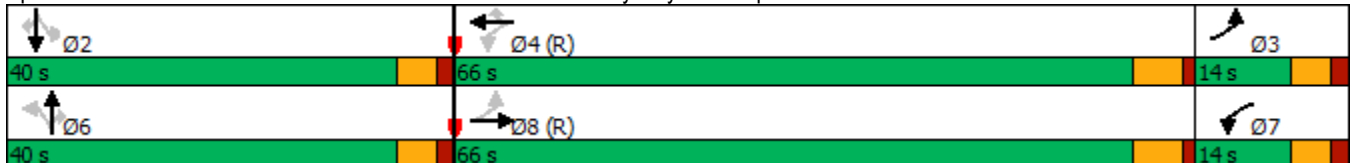
Intersection LOS: B

Intersection Capacity Utilization 54.7%

ICU Level of Service A

Analysis Period (min) 15

Splits and Phases: 15: 73rd Street/Dial Boulevard & Greenway Hayden Loop



15: 73rd Street/Dial Boulevard & Greenway Hayden Loop

08/18/2022



Movement	EBL	EBT	EBR	WBL	WBT	WBR	NBL	NBT	NBR	SBL	SBT	SBR
Lane Configurations												
Traffic Volume (veh/h)	99	549	61	206	787	45	106	93	383	51	81	105
Future Volume (veh/h)	99	549	61	206	787	45	106	93	383	51	81	105
Initial Q (Qb), veh	0	0	0	0	0	0	0	0	0	0	0	0
Ped-Bike Adj(A_pbT)	1.00		1.00	1.00		1.00	1.00		1.00	1.00		1.00
Parking Bus, Adj	1.00	1.00	1.00	1.00	1.00	1.00	1.00	1.00	1.00	1.00	1.00	1.00
Work Zone On Approach		No			No			No			No	
Adj Sat Flow, veh/h/ln	1870	1870	1870	1870	1870	1870	1870	1870	1870	1870	1870	1870
Adj Flow Rate, veh/h	108	597	66	224	855	49	115	101	416	55	88	114
Peak Hour Factor	0.92	0.92	0.92	0.92	0.92	0.92	0.92	0.92	0.92	0.92	0.92	0.92
Percent Heavy Veh, %	2	2	2	2	2	2	2	2	2	2	2	2
Cap, veh/h	609	794	87	829	1003	447	345	518	439	269	518	439
Arrive On Green	0.10	0.06	0.06	0.42	0.28	0.28	0.28	0.28	0.28	0.28	0.28	0.28
Sat Flow, veh/h	1781	4672	511	1781	3554	1585	1180	1870	1585	884	1870	1585
Grp Volume(v), veh/h	108	433	230	224	855	49	115	101	416	55	88	114
Grp Sat Flow(s),veh/h/ln	1781	1702	1778	1781	1777	1585	1180	1870	1585	884	1870	1585
Q Serve(g_s), s	2.5	15.0	15.3	3.8	27.3	2.7	9.8	5.0	30.9	6.1	4.3	6.7
Cycle Q Clear(g_c), s	2.5	15.0	15.3	3.8	27.3	2.7	14.1	5.0	30.9	11.0	4.3	6.7
Prop In Lane	1.00		0.29	1.00		1.00	1.00		1.00	1.00		1.00
Lane Grp Cap(c), veh/h	609	578	302	829	1003	447	345	518	439	269	518	439
V/C Ratio(X)	0.18	0.75	0.76	0.27	0.85	0.11	0.33	0.19	0.95	0.20	0.17	0.26
Avail Cap(c_a), veh/h	609	1719	898	829	1795	800	360	542	460	280	542	460
HCM Platoon Ratio	0.33	0.33	0.33	1.00	1.00	1.00	1.00	1.00	1.00	1.00	1.00	1.00
Upstream Filter(I)	0.79	0.79	0.79	1.00	1.00	1.00	1.00	1.00	1.00	1.00	1.00	1.00
Uniform Delay (d), s/veh	37.7	54.1	54.2	20.4	40.7	31.9	38.3	33.1	42.5	37.4	32.9	33.8
Incr Delay (d2), s/veh	0.0	6.9	13.3	0.1	9.1	0.5	0.2	0.1	27.9	0.1	0.1	0.1
Initial Q Delay(d3),s/veh	0.0	0.0	0.0	0.0	0.0	0.0	0.0	0.0	0.0	0.0	0.0	0.0
%ile BackOfQ(50%),veh/ln	2.9	7.5	8.4	3.8	13.1	1.1	2.9	2.3	15.4	1.3	2.0	2.6
Unsig. Movement Delay, s/veh												
LnGrp Delay(d),s/veh	37.8	61.0	67.5	20.5	49.8	32.4	38.5	33.2	70.4	37.5	33.0	33.9
LnGrp LOS	D	E	E	C	D	C	D	C	E	D	C	C
Approach Vol, veh/h		771			1128			632				257
Approach Delay, s/veh		59.7			43.2			58.6				34.3
Approach LOS		E			D			E				C
Timer - Assigned Phs		2	3	4		6	7	8				
Phs Duration (G+Y+Rc), s		38.5	42.3	39.3		38.5	55.8	25.8				
Change Period (Y+Rc), s		* 5.2	5.3	* 5.4		* 5.2	5.3	* 5.4				
Max Green Setting (Gmax), s		* 35	8.7	* 61		* 35	8.7	* 61				
Max Q Clear Time (g_c+I1), s		13.0	4.5	29.3		32.9	5.8	17.3				
Green Ext Time (p_c), s		0.7	0.0	4.6		0.4	0.1	3.1				

Intersection Summary

HCM 6th Ctrl Delay	50.5
HCM 6th LOS	D

Notes

User approved pedestrian interval to be less than phase max green.

* HCM 6th computational engine requires equal clearance times for the phases crossing the barrier.

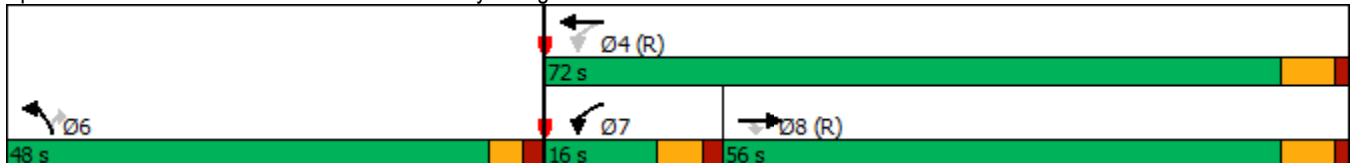


Lane Group	EBT	EBR	WBL	WBT	NBL	NBR
Lane Configurations	↑↑↑	↑	↓	↑↑↑	↓	↓
Traffic Volume (vph)	1281	104	224	1682	162	318
Future Volume (vph)	1281	104	224	1682	162	318
Turn Type	NA	Perm	pm+pt	NA	Prot	Perm
Protected Phases	8		7	4	6	
Permitted Phases		8	4			6
Detector Phase	8	8	7	4	6	6
Switch Phase						
Minimum Initial (s)	7.0	7.0	5.0	10.0	7.0	7.0
Minimum Split (s)	13.2	13.2	11.0	16.2	12.0	12.0
Total Split (s)	56.0	56.0	16.0	72.0	48.0	48.0
Total Split (%)	46.7%	46.7%	13.3%	60.0%	40.0%	40.0%
Yellow Time (s)	4.7	4.7	4.0	4.7	3.0	3.0
All-Red Time (s)	1.5	1.5	1.9	1.5	2.0	2.0
Lost Time Adjust (s)	0.0	0.0	0.0	0.0	0.0	0.0
Total Lost Time (s)	6.2	6.2	5.9	6.2	5.0	5.0
Lead/Lag	Lag	Lag	Lead			
Lead-Lag Optimize?	Yes	Yes	Yes			
Recall Mode	C-Min	C-Min	None	C-Min	None	None
Act Effct Green (s)	68.0	68.0	91.0	90.7	18.1	18.1
Actuated g/C Ratio	0.57	0.57	0.76	0.76	0.15	0.15
v/c Ratio	0.48	0.12	0.61	0.48	0.34	0.86
Control Delay	25.0	12.7	13.2	15.5	45.4	41.4
Queue Delay	0.0	0.0	0.0	0.0	0.0	0.0
Total Delay	25.0	12.7	13.2	15.5	45.4	41.4
LOS	C	B	B	B	D	D
Approach Delay	24.1			15.2	42.8	
Approach LOS	C			B	D	

Intersection Summary

Cycle Length: 120
 Actuated Cycle Length: 120
 Offset: 44 (37%), Referenced to phase 4:WBTL and 8:EBT, Start of 1st Green
 Natural Cycle: 50
 Control Type: Actuated-Coordinated
 Maximum v/c Ratio: 0.86
 Intersection Signal Delay: 22.0
 Intersection Capacity Utilization 57.2%
 Analysis Period (min) 15
 Intersection LOS: C
 ICU Level of Service B

Splits and Phases: 16: 76th Street & Frank Lloyd Wright Boulevard



16: 76th Street & Frank Lloyd Wright Boulevard

08/18/2022



Movement	EBT	EBR	WBL	WBT	NBL	NBR	
Lane Configurations	↑↑↑	↗	↖	↑↑↑	↖	↗	
Traffic Volume (veh/h)	1281	104	224	1682	162	318	
Future Volume (veh/h)	1281	104	224	1682	162	318	
Initial Q (Qb), veh	0	0	0	0	0	0	
Ped-Bike Adj(A_pbT)		1.00	1.00		1.00	1.00	
Parking Bus, Adj	1.00	1.00	1.00	1.00	1.00	1.00	
Work Zone On Approach	No			No	No		
Adj Sat Flow, veh/h/ln	1870	1870	1870	1870	1870	1870	
Adj Flow Rate, veh/h	1392	113	243	1828	176	346	
Peak Hour Factor	0.92	0.92	0.92	0.92	0.92	0.92	
Percent Heavy Veh, %	2	2	2	2	2	2	
Cap, veh/h	2763	858	389	3417	820	376	
Arrive On Green	1.00	1.00	0.16	1.00	0.24	0.24	
Sat Flow, veh/h	5274	1585	1781	5274	3456	1585	
Grp Volume(v), veh/h	1392	113	243	1828	176	346	
Grp Sat Flow(s),veh/h/ln	1702	1585	1781	1702	1728	1585	
Q Serve(g_s), s	0.0	0.0	7.5	0.0	4.9	25.6	
Cycle Q Clear(g_c), s	0.0	0.0	7.5	0.0	4.9	25.6	
Prop In Lane		1.00	1.00		1.00	1.00	
Lane Grp Cap(c), veh/h	2763	858	389	3417	820	376	
V/C Ratio(X)	0.50	0.13	0.62	0.53	0.21	0.92	
Avail Cap(c_a), veh/h	2763	858	398	3417	1238	568	
HCM Platoon Ratio	2.00	2.00	2.00	2.00	1.00	1.00	
Upstream Filter(l)	0.75	0.75	0.54	0.54	1.00	1.00	
Uniform Delay (d), s/veh	0.0	0.0	8.5	0.0	36.8	44.6	
Incr Delay (d2), s/veh	0.5	0.2	1.2	0.3	0.0	11.6	
Initial Q Delay(d3),s/veh	0.0	0.0	0.0	0.0	0.0	0.0	
%ile BackOfQ(50%),veh/ln	0.1	0.1	2.3	0.1	2.1	21.5	
Unsig. Movement Delay, s/veh							
LnGrp Delay(d),s/veh	0.5	0.2	9.7	0.3	36.8	56.3	
LnGrp LOS	A	A	A	A	D	E	
Approach Vol, veh/h	1505			2071	522		
Approach Delay, s/veh	0.5			1.4	49.7		
Approach LOS	A			A	D		
Timer - Assigned Phs				4	6	7	8
Phs Duration (G+Y+Rc), s				86.5	33.5	15.4	71.1
Change Period (Y+Rc), s				6.2	5.0	* 5.9	6.2
Max Green Setting (Gmax), s				65.8	43.0	* 10	49.8
Max Q Clear Time (g_c+I1), s				2.0	27.6	9.5	2.0
Green Ext Time (p_c), s				2.6	0.9	0.0	1.7

Intersection Summary

HCM 6th Ctrl Delay	7.2
HCM 6th LOS	A

Notes

User approved pedestrian interval to be less than phase max green.

* HCM 6th computational engine requires equal clearance times for the phases crossing the barrier.

Intersection

Intersection Delay, s/veh 10.2

Intersection LOS B

Movement	EBL	EBT	EBR	WBL	WBT	WBR	NBL	NBT	NBR	SBL	SBT	SBR
Lane Configurations												
Traffic Vol, veh/h	84	46	12	7	113	62	18	157	18	16	83	40
Future Vol, veh/h	84	46	12	7	113	62	18	157	18	16	83	40
Peak Hour Factor	0.92	0.92	0.92	0.92	0.92	0.92	0.92	0.92	0.92	0.92	0.92	0.92
Heavy Vehicles, %	2	2	2	2	2	2	2	2	2	2	2	2
Mvmt Flow	91	50	13	8	123	67	20	171	20	17	90	43
Number of Lanes	1	1	0	1	1	0	1	1	0	1	1	0

Approach	EB	WB	NB	SB
Opposing Approach	WB	EB	SB	NB
Opposing Lanes	2	2	2	2
Conflicting Approach Left	SB	NB	EB	WB
Conflicting Lanes Left	2	2	2	2
Conflicting Approach Right	NB	SB	WB	EB
Conflicting Lanes Right	2	2	2	2
HCM Control Delay	9.8	10.5	10.7	9.7
HCM LOS	A	B	B	A

Lane	NBLn1	NBLn2	EBLn1	EBLn2	WBLn1	WBLn2	SBLn1	SBLn2
Vol Left, %	100%	0%	100%	0%	100%	0%	100%	0%
Vol Thru, %	0%	90%	0%	79%	0%	65%	0%	67%
Vol Right, %	0%	10%	0%	21%	0%	35%	0%	33%
Sign Control	Stop	Stop	Stop	Stop	Stop	Stop	Stop	Stop
Traffic Vol by Lane	18	175	84	58	7	175	16	123
LT Vol	18	0	84	0	7	0	16	0
Through Vol	0	157	0	46	0	113	0	83
RT Vol	0	18	0	12	0	62	0	40
Lane Flow Rate	20	190	91	63	8	190	17	134
Geometry Grp	7	7	7	7	7	7	7	7
Degree of Util (X)	0.034	0.3	0.161	0.1	0.013	0.294	0.031	0.208
Departure Headway (Hd)	6.259	5.682	6.34	5.689	6.296	5.565	6.347	5.612
Convergence, Y/N	Yes	Yes	Yes	Yes	Yes	Yes	Yes	Yes
Cap	573	633	567	631	570	651	565	640
Service Time	3.986	3.409	4.068	3.416	4.021	3.265	4.076	3.34
HCM Lane V/C Ratio	0.035	0.3	0.16	0.1	0.014	0.292	0.03	0.209
HCM Control Delay	9.2	10.8	10.3	9.1	9.1	10.6	9.3	9.8
HCM Lane LOS	A	B	B	A	A	B	A	A
HCM 95th-tile Q	0.1	1.3	0.6	0.3	0	1.2	0.1	0.8

18: Greenway Hayden Loop & Frank Lloyd Wright Boulevard

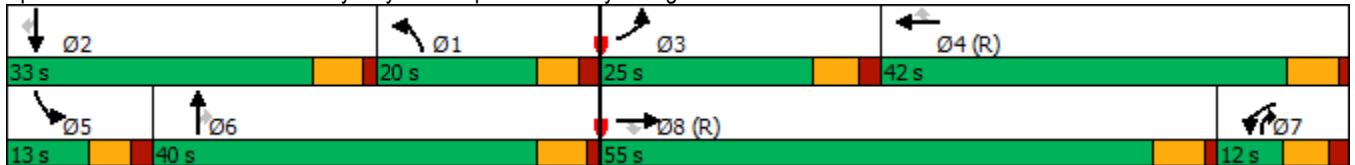
08/18/2022

Lane Group	EBL	EBT	EBR	WBL	WBT	WBR	NBL	NBT	NBR	SBL	SBT	SBR
Lane Configurations												
Traffic Volume (vph)	426	1373	48	468	1440	387	56	598	684	167	483	401
Future Volume (vph)	426	1373	48	468	1440	387	56	598	684	167	483	401
Turn Type	Prot	NA	Perm	Prot	NA	Perm	Prot	NA	pm+ov	Prot	NA	Perm
Protected Phases	3	8		7	4		1	6	7	5	2	
Permitted Phases			8			4			6			2
Detector Phase	3	8	8	7	4	4	1	6	7	5	2	2
Switch Phase												
Minimum Initial (s)	5.0	10.0	10.0	5.0	10.0	10.0	5.0	7.0	5.0	5.0	7.0	7.0
Minimum Split (s)	11.0	15.9	15.9	11.0	15.9	15.9	11.0	13.0	11.0	11.0	13.0	13.0
Total Split (s)	25.0	55.0	55.0	12.0	42.0	42.0	20.0	40.0	12.0	13.0	33.0	33.0
Total Split (%)	20.8%	45.8%	45.8%	10.0%	35.0%	35.0%	16.7%	33.3%	10.0%	10.8%	27.5%	27.5%
Yellow Time (s)	4.0	4.7	4.7	4.0	4.7	4.7	3.6	4.4	4.0	3.6	4.4	4.4
All-Red Time (s)	2.0	1.0	1.0	2.0	1.0	1.0	2.0	1.2	2.0	2.0	1.2	1.2
Lost Time Adjust (s)	0.0	0.0	0.0	0.0	0.0	0.0	0.0	0.0	0.0	0.0	0.0	0.0
Total Lost Time (s)	6.0	5.7	5.7	6.0	5.7	5.7	5.6	5.6	6.0	5.6	5.6	5.6
Lead/Lag	Lead	Lead	Lead	Lag	Lag	Lag	Lag	Lag	Lag	Lead	Lead	Lead
Lead-Lag Optimize?	Yes	Yes	Yes	Yes	Yes	Yes	Yes	Yes	Yes	Yes	Yes	Yes
Recall Mode	None	C-Min	C-Min	None	C-Min	C-Min	None	None	None	None	None	None
Act Effct Green (s)	19.3	45.6	45.6	18.3	44.6	44.6	10.2	25.8	43.7	7.4	25.1	25.1
Actuated g/C Ratio	0.16	0.38	0.38	0.15	0.37	0.37	0.08	0.22	0.36	0.06	0.21	0.21
v/c Ratio	0.84	0.77	0.07	0.97	0.83	0.60	0.41	0.86	1.13	0.86	0.71	0.65
Control Delay	78.0	35.9	1.4	84.3	40.0	22.4	60.4	58.6	102.7	90.5	50.4	8.6
Queue Delay	0.0	0.0	0.0	0.0	0.0	0.0	0.0	0.0	0.0	0.0	0.0	0.0
Total Delay	78.0	35.9	1.4	84.3	40.0	22.4	60.4	58.6	102.7	90.5	50.4	8.6
LOS	E	D	A	F	D	C	E	E	F	F	D	A
Approach Delay		44.7			46.0			81.2			40.9	
Approach LOS		D			D			F			D	

Intersection Summary

Cycle Length: 120
 Actuated Cycle Length: 120
 Offset: 38 (32%), Referenced to phase 4:WBT and 8:EBT, Start of 1st Green
 Natural Cycle: 90
 Control Type: Actuated-Coordinated
 Maximum v/c Ratio: 1.13
 Intersection Signal Delay: 52.0
 Intersection LOS: D
 Intersection Capacity Utilization 88.1%
 ICU Level of Service E
 Analysis Period (min) 15

Splits and Phases: 18: Greenway Hayden Loop & Frank Lloyd Wright Boulevard



18: Greenway Hayden Loop & Frank Lloyd Wright Boulevard

08/18/2022



Movement	EBL	EBT	EBR	WBL	WBT	WBR	NBL	NBT	NBR	SBL	SBT	SBR
Lane Configurations	↔↔	↑↑↑	↔	↔↔	↑↑↑	↔	↔	↑↑	↔	↔↔	↑↑	↔
Traffic Volume (veh/h)	426	1373	48	468	1440	387	56	598	684	167	483	401
Future Volume (veh/h)	426	1373	48	468	1440	387	56	598	684	167	483	401
Initial Q (Qb), veh	0	0	0	0	0	0	0	0	0	0	0	0
Ped-Bike Adj(A_pbT)	1.00		1.00	1.00		1.00	1.00		1.00	1.00		1.00
Parking Bus, Adj	1.00	1.00	1.00	1.00	1.00	1.00	1.00	1.00	1.00	1.00	1.00	1.00
Work Zone On Approach		No			No			No			No	
Adj Sat Flow, veh/h/ln	1870	1870	1870	1870	1870	1870	1870	1870	1870	1870	1870	1870
Adj Flow Rate, veh/h	463	1492	52	509	1565	421	61	650	743	182	525	436
Peak Hour Factor	0.92	0.92	0.92	0.92	0.92	0.92	0.92	0.92	0.92	0.92	0.92	0.92
Percent Heavy Veh, %	2	2	2	2	2	2	2	2	2	2	2	2
Cap, veh/h	520	1703	529	711	1973	613	178	740	656	213	603	269
Arrive On Green	0.05	0.11	0.11	0.21	0.39	0.39	0.10	0.21	0.21	0.06	0.17	0.17
Sat Flow, veh/h	3456	5106	1585	3456	5106	1585	1781	3554	1585	3456	3554	1585
Grp Volume(v), veh/h	463	1492	52	509	1565	421	61	650	743	182	525	436
Grp Sat Flow(s),veh/h/ln	1728	1702	1585	1728	1702	1585	1781	1777	1585	1728	1777	1585
Q Serve(g_s), s	16.0	34.5	3.5	16.5	32.5	26.6	3.8	21.3	16.8	6.3	17.3	14.3
Cycle Q Clear(g_c), s	16.0	34.5	3.5	16.5	32.5	26.6	3.8	21.3	16.8	6.3	17.3	14.3
Prop In Lane	1.00		1.00	1.00		1.00	1.00		1.00	1.00		1.00
Lane Grp Cap(c), veh/h	520	1703	529	711	1973	613	178	740	656	213	603	269
V/C Ratio(X)	0.89	0.88	0.10	0.72	0.79	0.69	0.34	0.88	1.13	0.85	0.87	1.62
Avail Cap(c_a), veh/h	547	2098	651	711	1973	613	214	1019	781	213	811	362
HCM Platoon Ratio	0.33	0.33	0.33	1.00	1.00	1.00	1.00	1.00	1.00	1.00	1.00	1.00
Upstream Filter(I)	0.81	0.81	0.81	1.00	1.00	1.00	1.00	1.00	1.00	1.00	1.00	1.00
Uniform Delay (d), s/veh	56.0	51.0	37.2	44.4	32.6	30.8	50.3	46.0	18.1	55.8	48.5	24.6
Incr Delay (d2), s/veh	13.0	5.5	0.3	3.0	3.4	6.2	0.4	5.4	76.2	25.9	6.3	295.5
Initial Q Delay(d3),s/veh	0.0	0.0	0.0	0.0	0.0	0.0	0.0	0.0	0.0	0.0	0.0	0.0
%ile BackOfQ(50%),veh/ln	8.3	16.5	1.4	7.1	13.3	10.7	1.7	9.7	24.1	3.4	8.0	27.2
Unsig. Movement Delay, s/veh												
LnGrp Delay(d),s/veh	69.0	56.5	37.5	47.3	35.9	36.9	50.7	51.4	94.3	81.7	54.8	320.1
LnGrp LOS	E	E	D	D	D	D	D	D	F	F	D	F
Approach Vol, veh/h		2007			2495			1454			1143	
Approach Delay, s/veh		58.9			38.4			73.3			160.3	
Approach LOS		E			D			E			F	
Timer - Assigned Phs	1	2	3	4	5	6	7	8				
Phs Duration (G+Y+Rc), s	17.6	26.0	24.0	52.4	13.0	30.6	30.7	45.7				
Change Period (Y+Rc), s	* 5.6	5.6	6.0	* 6	5.6	* 5.6	6.0	5.7				
Max Green Setting (Gmax), s	* 14	27.4	19.0	* 36	7.4	* 34	6.0	49.3				
Max Q Clear Time (g_c+I1), s	5.8	19.3	18.0	34.5	8.3	23.3	18.5	36.5				
Green Ext Time (p_c), s	0.0	1.1	0.1	1.0	0.0	1.7	0.0	3.5				

Intersection Summary

HCM 6th Ctrl Delay	71.0
HCM 6th LOS	E

Notes

User approved pedestrian interval to be less than phase max green.
 * HCM 6th computational engine requires equal clearance times for the phases crossing the barrier.

Intersection												
Int Delay, s/veh	2.6											
Movement	EBL	EBT	EBR	WBL	WBT	WBR	NBL	NBT	NBR	SBL	SBT	SBR
Lane Configurations		↕	↗		↕	↗	↖	↕	↖	↖	↕	↗
Traffic Vol, veh/h	11	1	23	23	1	71	28	1238	32	33	944	49
Future Vol, veh/h	11	1	23	23	1	71	28	1238	32	33	944	49
Conflicting Peds, #/hr	0	0	0	0	0	0	0	0	0	0	0	0
Sign Control	Stop	Stop	Stop	Stop	Stop	Stop	Free	Free	Free	Free	Free	Free
RT Channelized	-	-	None	-	-	None	-	-	None	-	-	None
Storage Length	-	-	130	-	-	130	150	-	-	110	-	175
Veh in Median Storage, #	-	0	-	-	0	-	-	0	-	-	0	-
Grade, %	-	0	-	-	0	-	-	0	-	-	0	-
Peak Hour Factor	92	92	92	92	92	92	92	92	92	92	92	92
Heavy Vehicles, %	2	2	2	2	2	2	2	2	2	2	2	2
Mvmt Flow	12	1	25	25	1	77	30	1346	35	36	1026	53

Major/Minor	Minor2		Minor1		Major1			Major2				
Conflicting Flow All	1832	2539	513	1992	2557	673	1079	0	0	1381	0	0
Stage 1	1098	1098	-	1406	1406	-	-	-	-	-	-	-
Stage 2	734	1441	-	586	1151	-	-	-	-	-	-	-
Critical Hdwy	7.54	6.54	6.94	7.54	6.54	6.94	4.14	-	-	4.14	-	-
Critical Hdwy Stg 1	6.54	5.54	-	6.54	5.54	-	-	-	-	-	-	-
Critical Hdwy Stg 2	6.54	5.54	-	6.54	5.54	-	-	-	-	-	-	-
Follow-up Hdwy	3.52	4.02	3.32	3.52	4.02	3.32	2.22	-	-	2.22	-	-
Pot Cap-1 Maneuver	*97	*25	*685	*63	24	398	*1024	-	-	492	-	-
Stage 1	*645	*566	-	*146	204	-	-	-	-	-	-	-
Stage 2	*378	*196	-	*645	525	-	-	-	-	-	-	-
Platoon blocked, %	1	1	1	1	1	1	1	-	-	-	-	-
Mov Cap-1 Maneuver	*69	*23	*685	*54	22	398	*1024	-	-	492	-	-
Mov Cap-2 Maneuver	*69	*23	-	*54	22	-	-	-	-	-	-	-
Stage 1	*627	*525	-	*142	198	-	-	-	-	-	-	-
Stage 2	*294	*190	-	*575	487	-	-	-	-	-	-	-

Approach	EB	WB	NB	SB
HCM Control Delay, s	35.2	46	0.2	0.4
HCM LOS	E	E		

Minor Lane/Major Mvmt	NBL	NBT	NBR	EBLn1	EBLn2	WBLn1	WBLn2	SBL	SBT	SBR
Capacity (veh/h)	* 1024	-	-	59	685	51	398	492	-	-
HCM Lane V/C Ratio	0.03	-	-	0.221	0.036	0.512	0.194	0.073	-	-
HCM Control Delay (s)	8.6	-	-	82.6	10.5	134	16.2	12.9	-	-
HCM Lane LOS	A	-	-	F	B	F	C	B	-	-
HCM 95th %tile Q(veh)	0.1	-	-	0.8	0.1	1.9	0.7	0.2	-	-

Notes
 ~: Volume exceeds capacity \$: Delay exceeds 300s +: Computation Not Defined *: All major volume in platoon



Appendix L – Year 2030 Build Capacity Analysis

1: Scottsdale Road & Bell Road/Frank Lloyd Wright Boulevard

08/18/2022



Movement	EBL	EBT	EBR	WBL	WBT	WBR	NBL	NBT	NBR	SBL	SBT	SBR
Lane Configurations	↔↔	↑↑↑	↔	↔↔	↑↑↑	↔	↔↔	↑↑↑	↔	↔↔	↑↑↑	↔
Traffic Volume (veh/h)	421	1215	406	193	484	222	192	774	115	399	1631	185
Future Volume (veh/h)	421	1215	406	193	484	222	192	774	115	399	1631	185
Initial Q (Qb), veh	0	0	0	0	0	0	0	0	0	0	0	0
Ped-Bike Adj(A_pbT)	1.00		1.00	1.00		1.00	1.00		1.00	1.00		1.00
Parking Bus, Adj	1.00	1.00	1.00	1.00	1.00	1.00	1.00	1.00	1.00	1.00	1.00	1.00
Work Zone On Approach		No			No			No			No	
Adj Sat Flow, veh/h/ln	1870	1870	1870	1870	1870	1870	1870	1870	1870	1870	1870	1870
Adj Flow Rate, veh/h	458	1321	441	210	526	241	209	841	125	434	1773	201
Peak Hour Factor	0.92	0.92	0.92	0.92	0.92	0.92	0.92	0.92	0.92	0.92	0.92	0.92
Percent Heavy Veh, %	2	2	2	2	2	2	2	2	2	2	2	2
Cap, veh/h	812	1455	452	259	646	734	259	960	298	1162	2084	235
Arrive On Green	0.24	0.29	0.29	0.15	0.25	0.25	0.02	0.06	0.06	0.34	0.45	0.45
Sat Flow, veh/h	3456	5106	1585	3456	5106	1585	3456	5106	1585	3456	4655	525
Grp Volume(v), veh/h	458	1321	441	210	526	241	209	841	125	434	1294	680
Grp Sat Flow(s),veh/h/ln	1728	1702	1585	1728	1702	1585	1728	1702	1585	1728	1702	1776
Q Serve(g_s), s	14.0	29.9	33.1	7.1	11.6	0.0	7.2	19.6	8.1	11.4	40.7	41.1
Cycle Q Clear(g_c), s	14.0	29.9	33.1	7.1	11.6	0.0	7.2	19.6	8.1	11.4	40.7	41.1
Prop In Lane	1.00		1.00	1.00		1.00	1.00		1.00	1.00		0.30
Lane Grp Cap(c), veh/h	812	1455	452	259	646	734	259	960	298	1162	1524	795
V/C Ratio(X)	0.56	0.91	0.98	0.81	0.81	0.33	0.81	0.88	0.42	0.37	0.85	0.85
Avail Cap(c_a), veh/h	812	1455	452	259	860	800	259	1072	333	1162	1524	795
HCM Platoon Ratio	1.00	1.00	1.00	2.00	2.00	2.00	0.33	0.33	0.33	1.00	1.00	1.00
Upstream Filter(I)	1.00	1.00	1.00	0.98	0.98	0.98	0.79	0.79	0.79	1.00	1.00	1.00
Uniform Delay (d), s/veh	40.5	41.4	42.5	50.2	43.5	17.0	57.6	54.9	39.4	30.2	29.5	29.7
Incr Delay (d2), s/veh	0.6	8.4	35.9	15.9	3.3	0.1	12.8	9.0	3.4	0.1	6.1	11.4
Initial Q Delay(d3),s/veh	0.0	0.0	0.0	0.0	0.0	0.0	0.0	0.0	0.0	0.0	0.0	0.0
%ile BackOfQ(50%),veh/ln	5.8	13.2	16.9	3.4	4.4	3.4	3.7	9.7	3.5	4.6	16.8	18.9
Unsig. Movement Delay, s/veh												
LnGrp Delay(d),s/veh	41.0	49.8	78.4	66.1	46.8	17.1	70.5	63.9	42.8	30.3	35.6	41.0
LnGrp LOS	D	D	E	E	D	B	E	E	D	C	D	D
Approach Vol, veh/h		2220			977			1175			2408	
Approach Delay, s/veh		53.7			43.6			62.8			36.2	
Approach LOS		D			D			E			D	
Timer - Assigned Phs	1	2	3	4	5	6	7	8				
Phs Duration (G+Y+Rc), s	15.0	59.7	34.2	21.0	46.4	28.4	15.0	40.2				
Change Period (Y+Rc), s	6.0	* 6	* 6	5.8	* 6	5.8	6.0	* 6				
Max Green Setting (Gmax), s	9.0	* 44	* 23	20.2	* 28	25.2	9.0	* 34				
Max Q Clear Time (g_c+I1), s	9.2	43.1	16.0	13.6	13.4	21.6	9.1	35.1				
Green Ext Time (p_c), s	0.0	0.7	0.6	1.6	0.7	1.0	0.0	0.0				

Intersection Summary

HCM 6th Ctrl Delay	47.6
HCM 6th LOS	D

Notes

User approved pedestrian interval to be less than phase max green.
 * HCM 6th computational engine requires equal clearance times for the phases crossing the barrier.

2: Scottsdale Road & Paradise Lane

08/18/2022

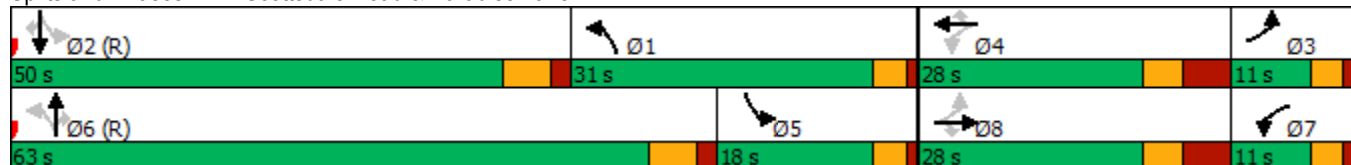


Lane Group	EBL	EBT	EBR	WBL	WBT	WBR	NBL	NBT	NBR	SBL	SBT	SBR
Lane Configurations	↘	↑	↗	↘	↑	↗	↘	↑↑↑	↗	↘	↑↑↑	↗
Traffic Volume (vph)	46	15	7	93	23	149	32	883	82	245	1658	54
Future Volume (vph)	46	15	7	93	23	149	32	883	82	245	1658	54
Turn Type	pm+pt	NA	Perm	pm+pt	NA	Perm	pm+pt	NA	Perm	pm+pt	NA	Perm
Protected Phases	3	8		7	4		1	6		5	2	
Permitted Phases	8		8	4		4	6		6	2		2
Detector Phase	3	8	8	7	4	4	1	6	6	5	2	2
Switch Phase												
Minimum Initial (s)	4.0	7.0	7.0	4.0	7.0	7.0	4.0	10.0	10.0	4.0	10.0	10.0
Minimum Split (s)	10.0	15.0	15.0	11.0	15.0	15.0	11.0	16.0	16.0	11.0	16.0	16.0
Total Split (s)	11.0	28.0	28.0	11.0	28.0	28.0	31.0	63.0	63.0	18.0	50.0	50.0
Total Split (%)	9.2%	23.3%	23.3%	9.2%	23.3%	23.3%	25.8%	52.5%	52.5%	15.0%	41.7%	41.7%
Yellow Time (s)	3.0	3.7	3.7	3.0	3.7	3.7	3.0	4.3	4.3	3.0	4.3	4.3
All-Red Time (s)	1.0	4.3	4.3	1.0	4.3	4.3	1.0	1.7	1.7	1.0	1.7	1.7
Lost Time Adjust (s)	0.0	0.0	0.0	0.0	0.0	0.0	0.0	0.0	0.0	0.0	0.0	0.0
Total Lost Time (s)	4.0	8.0	8.0	4.0	8.0	8.0	4.0	6.0	6.0	4.0	6.0	6.0
Lead/Lag	Lag	Lead	Lead	Lag	Lead	Lead	Lag	Lead	Lead	Lag	Lead	Lead
Lead-Lag Optimize?	Yes	Yes	Yes	Yes	Yes	Yes	Yes	Yes	Yes	Yes	Yes	Yes
Recall Mode	None	None	None	Min	None	None	Max	C-Min	C-Min	None	C-Min	C-Min
Act Effct Green (s)	12.3	7.0	7.0	18.6	8.1	8.1	71.2	38.3	38.3	91.9	55.0	55.0
Actuated g/C Ratio	0.10	0.06	0.06	0.16	0.07	0.07	0.59	0.32	0.32	0.77	0.46	0.46
v/c Ratio	0.27	0.15	0.03	0.40	0.20	0.63	0.07	0.59	0.15	0.32	0.77	0.07
Control Delay	46.6	56.9	0.3	48.7	55.8	19.4	13.8	42.8	10.9	21.6	18.2	0.3
Queue Delay	0.0	0.0	0.0	0.0	0.0	0.0	0.0	0.0	0.0	0.0	0.0	0.0
Total Delay	46.6	56.9	0.3	48.7	55.8	19.4	13.8	42.8	10.9	21.6	18.2	0.3
LOS	D	E	A	D	E	B	B	D	B	C	B	A
Approach Delay		43.8			32.8			39.2			18.1	
Approach LOS		D			C			D			B	

Intersection Summary

Cycle Length: 120
 Actuated Cycle Length: 120
 Offset: 20 (17%), Referenced to phase 2:SBTL and 6:NBTL, Start of 1st Green
 Natural Cycle: 65
 Control Type: Actuated-Coordinated
 Maximum v/c Ratio: 0.77
 Intersection Signal Delay: 26.3
 Intersection LOS: C
 Intersection Capacity Utilization 62.2%
 ICU Level of Service B
 Analysis Period (min) 15

Splits and Phases: 2: Scottsdale Road & Paradise Lane



2: Scottsdale Road & Paradise Lane

08/18/2022



Movement	EBL	EBT	EBR	WBL	WBT	WBR	NBL	NBT	NBR	SBL	SBT	SBR
Lane Configurations	↖	↗	↘	↖	↗	↘	↖	↗↘	↗	↖	↗↘	↗
Traffic Volume (veh/h)	46	15	7	93	23	149	32	883	82	245	1658	54
Future Volume (veh/h)	46	15	7	93	23	149	32	883	82	245	1658	54
Initial Q (Qb), veh	0	0	0	0	0	0	0	0	0	0	0	0
Ped-Bike Adj(A_pbT)	1.00		1.00	1.00		1.00	1.00		1.00	1.00		1.00
Parking Bus, Adj	1.00	1.00	1.00	1.00	1.00	1.00	1.00	1.00	1.00	1.00	1.00	1.00
Work Zone On Approach		No			No			No			No	
Adj Sat Flow, veh/h/ln	1870	1870	1870	1870	1870	1870	1870	1870	1870	1870	1870	1870
Adj Flow Rate, veh/h	50	16	8	101	25	162	35	960	89	266	1802	59
Peak Hour Factor	0.92	0.92	0.92	0.92	0.92	0.92	0.92	0.92	0.92	0.92	0.92	0.92
Percent Heavy Veh, %	2	2	2	2	2	2	2	2	2	2	2	2
Cap, veh/h	164	109	92	271	221	188	602	1043	324	897	1872	581
Arrive On Green	0.03	0.06	0.06	0.09	0.12	0.12	0.61	0.41	0.41	0.15	0.12	0.12
Sat Flow, veh/h	1781	1870	1585	1781	1870	1585	1781	5106	1585	1781	5106	1585
Grp Volume(v), veh/h	50	16	8	101	25	162	35	960	89	266	1802	59
Grp Sat Flow(s),veh/h/ln	1781	1870	1585	1781	1870	1585	1781	1702	1585	1781	1702	1585
Q Serve(g_s), s	0.0	1.0	0.6	0.0	1.4	12.0	0.0	21.4	4.5	11.3	42.1	4.0
Cycle Q Clear(g_c), s	0.0	1.0	0.6	0.0	1.4	12.0	0.0	21.4	4.5	11.3	42.1	4.0
Prop In Lane	1.00		1.00	1.00		1.00	1.00		1.00	1.00		1.00
Lane Grp Cap(c), veh/h	164	109	92	271	221	188	602	1043	324	897	1872	581
V/C Ratio(X)	0.31	0.15	0.09	0.37	0.11	0.86	0.06	0.92	0.27	0.30	0.96	0.10
Avail Cap(c_a), veh/h	219	312	264	271	312	264	602	2425	753	897	1872	581
HCM Platoon Ratio	1.00	1.00	1.00	1.00	1.00	1.00	2.00	2.00	2.00	0.33	0.33	0.33
Upstream Filter(I)	1.00	1.00	1.00	1.00	1.00	1.00	1.00	1.00	1.00	0.14	0.14	0.14
Uniform Delay (d), s/veh	53.8	53.7	53.5	48.7	47.3	51.9	16.3	34.6	29.6	30.5	51.9	35.1
Incr Delay (d2), s/veh	0.4	0.2	0.1	0.3	0.1	14.2	0.2	14.3	2.1	0.0	2.9	0.0
Initial Q Delay(d3),s/veh	0.0	0.0	0.0	0.0	0.0	0.0	0.0	0.0	0.0	0.0	0.0	0.0
%ile BackOfQ(50%),veh/ln	1.5	0.5	0.2	2.8	0.7	5.6	0.4	7.8	1.8	7.2	19.6	1.6
Unsig. Movement Delay, s/veh												
LnGrp Delay(d),s/veh	54.1	53.9	53.6	49.0	47.3	66.1	16.5	48.9	31.7	30.5	54.9	35.2
LnGrp LOS	D	D	D	D	D	E	B	D	C	C	D	D
Approach Vol, veh/h		74			288			1084			2127	
Approach Delay, s/veh		54.0			58.5			46.4			51.3	
Approach LOS		D			E			D			D	
Timer - Assigned Phs	1	2	3	4	5	6	7	8				
Phs Duration (G+Y+Rc), s	40.5	50.0	7.2	22.2	60.0	30.5	14.5	15.0				
Change Period (Y+Rc), s	* 4	6.0	* 4	8.0	* 4	6.0	* 4	8.0				
Max Green Setting (Gmax), s	* 27	44.0	* 7	20.0	* 14	57.0	* 7	20.0				
Max Q Clear Time (g_c+I1), s	2.0	44.1	2.0	14.0	13.3	23.4	2.0	3.0				
Green Ext Time (p_c), s	0.0	0.0	0.0	0.2	0.0	1.1	0.0	0.0				

Intersection Summary

HCM 6th Ctrl Delay	50.4
HCM 6th LOS	D

Notes

- User approved pedestrian interval to be less than phase max green.
- * HCM 6th computational engine requires equal clearance times for the phases crossing the barrier.

3: Scottsdale Road & Driveway A

08/18/2022

Intersection												
Int Delay, s/veh	0.3											
Movement	EBL	EBT	EBR	WBL	WBT	WBR	NBL	NBT	NBR	SBL	SBT	SBR
Lane Configurations			↗			↗	↘ ↗ ↗	↘ ↗ ↗	↗	↘ ↗ ↗	↗	
Traffic Vol, veh/h	0	0	2	0	0	32	7	963	60	52	1708	4
Future Vol, veh/h	0	0	2	0	0	32	7	963	60	52	1708	4
Conflicting Peds, #/hr	0	0	0	0	0	0	0	0	0	0	0	0
Sign Control	Stop	Stop	Stop	Stop	Stop	Stop	Free	Free	Free	Free	Free	Free
RT Channelized	-	-	None	-	-	None	-	-	None	-	-	None
Storage Length	-	-	0	-	-	0	110	-	150	150	-	110
Veh in Median Storage, #	-	0	-	-	0	-	-	0	-	-	0	-
Grade, %	-	0	-	-	0	-	-	0	-	-	0	-
Peak Hour Factor	92	92	92	92	92	92	92	92	92	92	92	92
Heavy Vehicles, %	2	2	2	2	2	2	2	2	2	2	2	2
Mvmt Flow	0	0	2	0	0	35	8	1047	65	57	1857	4

Major/Minor	Minor2		Minor1		Major1			Major2				
Conflicting Flow All	-	-	929	-	-	524	1861	0	0	1112	0	0
Stage 1	-	-	-	-	-	-	-	-	-	-	-	-
Stage 2	-	-	-	-	-	-	-	-	-	-	-	-
Critical Hdwy	-	-	7.14	-	-	7.14	5.34	-	-	5.34	-	-
Critical Hdwy Stg 1	-	-	-	-	-	-	-	-	-	-	-	-
Critical Hdwy Stg 2	-	-	-	-	-	-	-	-	-	-	-	-
Follow-up Hdwy	-	-	3.92	-	-	3.92	3.12	-	-	3.12	-	-
Pot Cap-1 Maneuver	0	0	*524	0	0	*697	*658	-	-	840	-	-
Stage 1	0	0	-	0	0	-	-	-	-	-	-	-
Stage 2	0	0	-	0	0	-	-	-	-	-	-	-
Platoon blocked, %			1			1	1	-	-	1	-	-
Mov Cap-1 Maneuver	-	-	*524	-	-	*697	*658	-	-	840	-	-
Mov Cap-2 Maneuver	-	-	-	-	-	-	-	-	-	-	-	-
Stage 1	-	-	-	-	-	-	-	-	-	-	-	-
Stage 2	-	-	-	-	-	-	-	-	-	-	-	-

Approach	EB		WB		NB			SB		
HCM Control Delay, s	11.9		10.4		0.1			0.3		
HCM LOS	B		B							

Minor Lane/Major Mvmt	NBL	NBT	NBR	EBLn1	WBLn1	SBL	SBT	SBR
Capacity (veh/h)	* 658	-	-	524	697	840	-	-
HCM Lane V/C Ratio	0.012	-	-	0.004	0.05	0.067	-	-
HCM Control Delay (s)	10.5	-	-	11.9	10.4	9.6	-	-
HCM Lane LOS	B	-	-	B	B	A	-	-
HCM 95th %tile Q(veh)	0	-	-	0	0.2	0.2	-	-

Notes
 ~: Volume exceeds capacity \$: Delay exceeds 300s +: Computation Not Defined *: All major volume in platoon

4: Scottsdale Road & Tierra Buena Lane

08/18/2022



Movement	EBL	EBT	EBR	WBL	WBT	WBR	NBL	NBT	NBR	SBL	SBT	SBR
Lane Configurations	↖	↗		↖	↖	↗	↖	↖↖↖	↗	↖	↖↖↖	↗
Traffic Volume (veh/h)	12	4	17	86	1	119	15	906	81	126	1557	20
Future Volume (veh/h)	12	4	17	86	1	119	15	906	81	126	1557	20
Initial Q (Qb), veh	0	0	0	0	0	0	0	0	0	0	0	0
Ped-Bike Adj(A_pbT)	1.00		1.00	1.00		1.00	1.00		1.00	1.00		1.00
Parking Bus, Adj	1.00	1.00	1.00	1.00	1.00	1.00	1.00	1.00	1.00	1.00	1.00	1.00
Work Zone On Approach		No			No			No			No	
Adj Sat Flow, veh/h/ln	1870	1870	1870	1870	1870	1870	1870	1870	1870	1870	1870	1870
Adj Flow Rate, veh/h	13	4	18	93	1	129	16	985	88	137	1692	22
Peak Hour Factor	0.92	0.92	0.92	0.92	0.92	0.92	0.92	0.92	0.92	0.92	0.92	0.92
Percent Heavy Veh, %	2	2	2	2	2	2	2	2	2	2	2	2
Cap, veh/h	153	17	77	215	183	155	708	1160	360	935	1753	544
Arrive On Green	0.01	0.06	0.06	0.05	0.10	0.10	0.73	0.45	0.45	0.96	0.69	0.69
Sat Flow, veh/h	1781	296	1334	1781	1870	1585	1781	5106	1585	1781	5106	1585
Grp Volume(v), veh/h	13	0	22	93	1	129	16	985	88	137	1692	22
Grp Sat Flow(s),veh/h/ln	1781	0	1630	1781	1870	1585	1781	1702	1585	1781	1702	1585
Q Serve(g_s), s	0.0	0.0	1.5	0.0	0.1	9.6	0.0	20.6	4.1	0.0	36.9	0.5
Cycle Q Clear(g_c), s	0.0	0.0	1.5	0.0	0.1	9.6	0.0	20.6	4.1	0.0	36.9	0.5
Prop In Lane	1.00		0.82	1.00		1.00	1.00		1.00	1.00		1.00
Lane Grp Cap(c), veh/h	153	0	95	215	183	155	708	1160	360	935	1753	544
V/C Ratio(X)	0.08	0.00	0.23	0.43	0.01	0.83	0.02	0.85	0.24	0.15	0.97	0.04
Avail Cap(c_a), veh/h	237	0	340	227	390	330	708	2425	753	935	2425	753
HCM Platoon Ratio	1.00	1.00	1.00	1.00	1.00	1.00	2.00	2.00	2.00	2.00	2.00	2.00
Upstream Filter(I)	1.00	0.00	1.00	1.00	1.00	1.00	0.88	0.88	0.88	1.00	1.00	1.00
Uniform Delay (d), s/veh	52.5	0.0	54.0	52.1	48.9	53.2	10.4	30.9	26.4	1.1	18.1	12.4
Incr Delay (d2), s/veh	0.1	0.0	0.5	0.5	0.0	4.3	0.0	7.0	1.4	0.0	14.7	0.1
Initial Q Delay(d3),s/veh	0.0	0.0	0.0	0.0	0.0	0.0	0.0	0.0	0.0	0.0	0.0	0.0
%ile BackOfQ(50%),veh/ln	0.4	0.0	0.6	2.7	0.0	4.0	0.1	6.7	1.6	0.1	8.2	0.2
Unsig. Movement Delay, s/veh												
LnGrp Delay(d),s/veh	52.6	0.0	54.4	52.7	48.9	57.5	10.4	37.9	27.8	1.1	32.8	12.6
LnGrp LOS	D	A	D	D	D	E	B	D	C	A	C	B
Approach Vol, veh/h		35			223			1089			1851	
Approach Delay, s/veh		53.7			55.4			36.6			30.2	
Approach LOS		D			E			D			C	
Timer - Assigned Phs	1	2	3	4	5	6	7	8				
Phs Duration (G+Y+Rc), s	47.6	47.2	5.4	19.7	61.6	33.3	10.2	15.0				
Change Period (Y+Rc), s	* 4	6.0	* 4	8.0	* 4	6.0	* 4	8.0				
Max Green Setting (Gmax), s	* 9	57.0	* 7	25.0	* 9	57.0	* 7	25.0				
Max Q Clear Time (g_c+I1), s	2.0	38.9	2.0	11.6	2.0	22.6	2.0	3.5				
Green Ext Time (p_c), s	0.0	2.3	0.0	0.2	0.1	4.7	0.0	0.0				

Intersection Summary

HCM 6th Ctrl Delay	34.4
HCM 6th LOS	C

Notes

- User approved pedestrian interval to be less than phase max green.
- * HCM 6th computational engine requires equal clearance times for the phases crossing the barrier.

5: Scottsdale Road & Kierland Boulevard/Greenway Hayden Loop

08/18/2022



Movement	EBL	EBT	EBR	WBL	WBT	WBR	NBL	NBT	NBR	SBL	SBT	SBR
Lane Configurations	↔↔	↑↑	↗	↔↔	↑↑↔		↔↔	↑↑↑	↗	↔↔	↑↑↑	↗
Traffic Volume (veh/h)	57	145	44	307	195	51	44	912	422	160	1290	183
Future Volume (veh/h)	57	145	44	307	195	51	44	912	422	160	1290	183
Initial Q (Qb), veh	0	0	0	0	0	0	0	0	0	0	0	0
Ped-Bike Adj(A_pbT)	1.00		1.00	1.00		1.00	1.00		1.00	1.00		1.00
Parking Bus, Adj	1.00	1.00	1.00	1.00	1.00	1.00	1.00	1.00	1.00	1.00	1.00	1.00
Work Zone On Approach		No			No			No			No	
Adj Sat Flow, veh/h/ln	1870	1870	1870	1870	1870	1870	1870	1870	1870	1870	1870	1870
Adj Flow Rate, veh/h	62	158	48	334	212	55	48	991	459	174	1402	199
Peak Hour Factor	0.92	0.92	0.92	0.92	0.92	0.92	0.92	0.92	0.92	0.92	0.92	0.92
Percent Heavy Veh, %	2	2	2	2	2	2	2	2	2	2	2	2
Cap, veh/h	342	233	104	392	323	79	787	1184	368	1377	2055	638
Arrive On Green	0.10	0.07	0.07	0.04	0.03	0.03	0.46	0.46	0.46	0.80	0.81	0.81
Sat Flow, veh/h	3456	3554	1585	3456	4090	1004	3456	5106	1585	3456	5106	1585
Grp Volume(v), veh/h	62	158	48	334	174	93	48	991	459	174	1402	199
Grp Sat Flow(s),veh/h/ln	1728	1777	1585	1728	1702	1690	1728	1702	1585	1728	1702	1585
Q Serve(g_s), s	2.0	5.2	2.3	11.5	6.1	6.5	0.9	20.4	20.3	1.4	14.3	3.9
Cycle Q Clear(g_c), s	2.0	5.2	2.3	11.5	6.1	6.5	0.9	20.4	20.3	1.4	14.3	3.9
Prop In Lane	1.00		1.00	1.00		0.59	1.00		1.00	1.00		1.00
Lane Grp Cap(c), veh/h	342	233	104	392	269	133	787	1184	368	1377	2055	638
V/C Ratio(X)	0.18	0.68	0.46	0.85	0.65	0.69	0.06	0.84	1.25	0.13	0.68	0.31
Avail Cap(c_a), veh/h	342	841	375	415	916	455	787	2055	638	1377	2055	638
HCM Platoon Ratio	1.00	1.00	1.00	0.33	0.33	0.33	2.00	2.00	2.00	2.00	2.00	2.00
Upstream Filter(I)	1.00	1.00	1.00	0.90	0.90	0.90	0.88	0.88	0.88	0.90	0.90	0.90
Uniform Delay (d), s/veh	49.6	54.8	23.0	56.8	56.8	57.0	25.5	30.2	17.1	7.5	8.4	7.4
Incr Delay (d2), s/veh	0.1	1.3	1.2	12.9	0.9	2.2	0.0	6.3	130.4	0.0	1.7	1.1
Initial Q Delay(d3),s/veh	0.0	0.0	0.0	0.0	0.0	0.0	0.0	0.0	0.0	0.0	0.0	0.0
%ile BackOfQ(50%),veh/ln	0.9	2.4	1.4	6.0	2.7	2.9	0.4	6.6	18.1	0.5	3.1	1.3
Unsig. Movement Delay, s/veh												
LnGrp Delay(d),s/veh	49.7	56.1	24.2	69.6	57.7	59.2	25.5	36.5	147.5	7.5	10.1	8.5
LnGrp LOS	D	E	C	E	E	E	C	D	F	A	B	A
Approach Vol, veh/h		268			601			1498			1775	
Approach Delay, s/veh		48.9			64.5			70.2			9.6	
Approach LOS		D			E			E			A	
Timer - Assigned Phs	1	2	3	4	5	6	7	8				
Phs Duration (G+Y+Rc), s	33.3	54.0	17.5	15.2	53.8	33.5	19.2	13.5				
Change Period (Y+Rc), s	6.0	5.7	* 5.6	* 5.7	6.0	5.7	5.6	* 5.6				
Max Green Setting (Gmax), s	6.0	48.3	* 11	* 32	6.0	48.3	14.4	* 28				
Max Q Clear Time (g_c+I1), s	2.9	16.3	4.0	8.5	3.4	22.4	13.5	7.2				
Green Ext Time (p_c), s	0.0	7.7	0.0	1.0	0.1	5.4	0.1	0.6				

Intersection Summary

HCM 6th Ctrl Delay	42.0
HCM 6th LOS	D

Notes

User approved pedestrian interval to be less than phase max green.
 * HCM 6th computational engine requires equal clearance times for the phases crossing the barrier.

6: Scottsdale Road & Greenway Parkway/Butherus Drive

08/18/2022

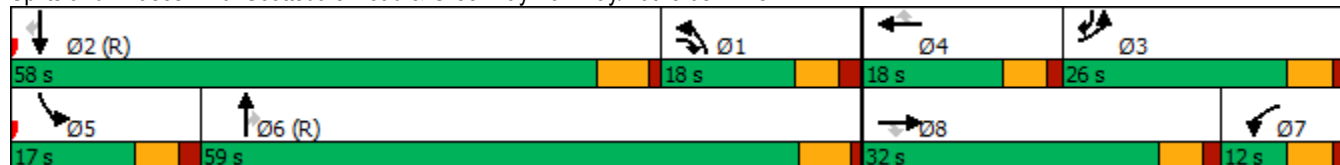


Lane Group	EBL	EBT	EBR	WBL	WBT	WBR	NBL	NBT	NBR	SBL	SBT	SBR
Lane Configurations	↔↔	↕↔	↗	↔↔	↕↕	↗	↔↔	↕↕↕	↗	↔↔	↕↕↕	↗
Traffic Volume (vph)	340	425	365	98	71	37	188	1022	301	149	1341	130
Future Volume (vph)	340	425	365	98	71	37	188	1022	301	149	1341	130
Turn Type	Prot	NA	pm+ov	Prot	NA	Perm	Prot	NA	Perm	Prot	NA	pm+ov
Protected Phases	3	8	1	7	4		1	6		5	2	3
Permitted Phases			8			4			6			2
Detector Phase	3	8	1	7	4	4	1	6	6	5	2	3
Switch Phase												
Minimum Initial (s)	5.0	7.0	5.0	5.0	7.0	7.0	5.0	10.0	10.0	5.0	10.0	5.0
Minimum Split (s)	11.0	13.2	11.0	11.0	13.2	13.2	11.0	16.0	16.0	11.0	16.0	11.0
Total Split (s)	26.0	32.0	18.0	12.0	18.0	18.0	18.0	59.0	59.0	17.0	58.0	26.0
Total Split (%)	21.7%	26.7%	15.0%	10.0%	15.0%	15.0%	15.0%	49.2%	49.2%	14.2%	48.3%	21.7%
Yellow Time (s)	4.0	4.0	4.0	4.0	4.0	4.0	4.0	4.7	4.7	4.0	4.7	4.0
All-Red Time (s)	2.0	1.5	2.0	2.0	1.5	1.5	2.0	1.0	1.0	2.0	1.0	2.0
Lost Time Adjust (s)	0.0	0.0	0.0	0.0	0.0	0.0	0.0	0.0	0.0	0.0	0.0	0.0
Total Lost Time (s)	6.0	5.5	6.0	6.0	5.5	5.5	6.0	5.7	5.7	6.0	5.7	6.0
Lead/Lag	Lag	Lead	Lag	Lag	Lead	Lead	Lag	Lag	Lag	Lead	Lead	Lag
Lead-Lag Optimize?	Yes	Yes	Yes	Yes	Yes	Yes	Yes	Yes	Yes	Yes	Yes	Yes
Recall Mode	None	None	None	None	None	None	None	C-Min	C-Min	None	C-Min	None
Act Effct Green (s)	26.6	24.4	42.3	7.3	7.6	7.6	12.4	55.5	55.5	9.6	52.7	85.0
Actuated g/C Ratio	0.22	0.20	0.35	0.06	0.06	0.06	0.10	0.46	0.46	0.08	0.44	0.71
v/c Ratio	0.49	0.87	0.44	0.52	0.34	0.12	0.58	0.47	0.39	0.59	0.65	0.12
Control Delay	43.7	57.9	15.4	63.8	57.9	0.8	57.5	23.7	10.0	59.4	20.1	1.3
Queue Delay	0.0	0.0	0.0	0.0	0.0	0.0	0.0	0.0	0.0	0.0	0.0	0.0
Total Delay	43.7	57.9	15.4	63.8	57.9	0.8	57.5	23.7	10.0	59.4	20.1	1.3
LOS	D	E	B	E	E	A	E	C	B	E	C	A
Approach Delay		44.6			50.5			25.2			22.2	
Approach LOS		D			D			C			C	

Intersection Summary

Cycle Length: 120
 Actuated Cycle Length: 120
 Offset: 53 (44%), Referenced to phase 2:SBT and 6:NBT, Start of 1st Green
 Natural Cycle: 70
 Control Type: Actuated-Coordinated
 Maximum v/c Ratio: 0.87
 Intersection Signal Delay: 30.2
 Intersection Capacity Utilization 70.4%
 Analysis Period (min) 15
 Intersection LOS: C
 ICU Level of Service C

Splits and Phases: 6: Scottsdale Road & Greenway Parkway/Butherus Drive



6: Scottsdale Road & Greenway Parkway/Butherus Drive

08/18/2022



Movement	EBL	EBT	EBR	WBL	WBT	WBR	NBL	NBT	NBR	SBL	SBT	SBR
Lane Configurations	↔↔	↕↔	↔↔	↔↔	↕↕	↔↔	↔↔	↕↕↕	↔↔	↔↔	↕↕↕	↔↔
Traffic Volume (veh/h)	340	425	365	98	71	37	188	1022	301	149	1341	130
Future Volume (veh/h)	340	425	365	98	71	37	188	1022	301	149	1341	130
Initial Q (Qb), veh	0	0	0	0	0	0	0	0	0	0	0	0
Ped-Bike Adj(A_pbT)	1.00		1.00	1.00		1.00	1.00		1.00	1.00		1.00
Parking Bus, Adj	1.00	1.00	1.00	1.00	1.00	1.00	1.00	1.00	1.00	1.00	1.00	1.00
Work Zone On Approach		No			No			No			No	
Adj Sat Flow, veh/h/ln	1870	1870	1870	1870	1870	1870	1870	1870	1870	1870	1870	1870
Adj Flow Rate, veh/h	370	628	286	107	77	40	204	1111	0	162	1458	141
Peak Hour Factor	0.92	0.92	0.92	0.92	0.92	0.92	0.92	0.92	0.92	0.92	0.92	0.92
Percent Heavy Veh, %	2	2	2	2	2	2	2	2	2	2	2	2
Cap, veh/h	641	720	701	158	207	92	864	2571		215	1626	790
Arrive On Green	0.18	0.19	0.19	0.05	0.06	0.06	0.25	0.50	0.00	0.12	0.64	0.64
Sat Flow, veh/h	3563	3741	1585	3456	3554	1585	3456	5106	1585	3456	5106	1585
Grp Volume(v), veh/h	370	628	286	107	77	40	204	1111	0	162	1458	141
Grp Sat Flow(s),veh/h/ln	1781	1870	1585	1728	1777	1585	1728	1702	1585	1728	1702	1585
Q Serve(g_s), s	11.4	19.6	0.0	3.7	2.5	2.4	5.6	16.6	0.0	5.4	29.0	0.0
Cycle Q Clear(g_c), s	11.4	19.6	0.0	3.7	2.5	2.4	5.6	16.6	0.0	5.4	29.0	0.0
Prop In Lane	1.00		1.00	1.00		1.00	1.00		1.00	1.00		1.00
Lane Grp Cap(c), veh/h	641	720	701	158	207	92	864	2571		215	1626	790
V/C Ratio(X)	0.58	0.87	0.41	0.68	0.37	0.43	0.24	0.43		0.75	0.90	0.18
Avail Cap(c_a), veh/h	641	826	746	173	370	165	864	2571		317	2225	976
HCM Platoon Ratio	1.00	1.00	1.00	1.00	1.00	1.00	1.00	1.00	1.00	2.00	2.00	2.00
Upstream Filter(I)	1.00	1.00	1.00	1.00	1.00	1.00	1.00	1.00	0.00	0.83	0.83	0.83
Uniform Delay (d), s/veh	45.0	47.0	22.8	56.4	54.4	37.8	35.9	18.9	0.0	51.6	20.1	8.4
Incr Delay (d2), s/veh	0.8	8.3	0.1	6.8	0.4	1.2	0.1	0.5	0.0	2.1	6.9	0.4
Initial Q Delay(d3),s/veh	0.0	0.0	0.0	0.0	0.0	0.0	0.0	0.0	0.0	0.0	0.0	0.0
%ile BackOfQ(50%),veh/ln	5.0	9.7	5.3	1.7	1.1	1.2	2.3	6.3	0.0	2.3	6.9	1.1
Unsig. Movement Delay, s/veh												
LnGrp Delay(d),s/veh	45.9	55.4	22.9	63.1	54.8	39.0	35.9	19.4	0.0	53.7	27.1	8.9
LnGrp LOS	D	E	C	E	D	D	D	B		D	C	A
Approach Vol, veh/h		1284			224			1315			1761	
Approach Delay, s/veh		45.4			55.9			22.0			28.1	
Approach LOS		D			E			C			C	
Timer - Assigned Phs	1	2	3	4	5	6	7	8				
Phs Duration (G+Y+Rc), s	36.0	43.9	27.6	12.5	13.5	66.4	11.5	28.6				
Change Period (Y+Rc), s	6.0	5.7	6.0	5.5	6.0	* 6	6.0	5.5				
Max Green Setting (Gmax), s	12.0	52.3	20.0	12.5	11.0	* 53	6.0	26.5				
Max Q Clear Time (g_c+I1), s	7.6	31.0	13.4	4.5	7.4	18.6	5.7	21.6				
Green Ext Time (p_c), s	0.1	7.2	0.4	0.2	0.1	5.3	0.0	1.5				

Intersection Summary

HCM 6th Ctrl Delay	32.5
HCM 6th LOS	C

Notes

- User approved pedestrian interval to be less than phase max green.
- User approved volume balancing among the lanes for turning movement.
- * HCM 6th computational engine requires equal clearance times for the phases crossing the barrier.

Intersection						
Int Delay, s/veh	0.4					
Movement	EBT	EBR	WBL	WBT	NBL	NBR
Lane Configurations	↔			↑		↗
Traffic Vol, veh/h	341	57	0	298	0	27
Future Vol, veh/h	341	57	0	298	0	27
Conflicting Peds, #/hr	0	0	0	0	0	0
Sign Control	Free	Free	Free	Free	Stop	Stop
RT Channelized	-	None	-	None	-	None
Storage Length	-	-	-	-	-	0
Veh in Median Storage, #	0	-	-	0	0	-
Grade, %	0	-	-	0	0	-
Peak Hour Factor	92	92	92	92	92	92
Heavy Vehicles, %	2	2	2	2	2	2
Mvmt Flow	371	62	0	324	0	29
Major/Minor	Major1	Major2	Minor1			
Conflicting Flow All	0	0	-	-	-	402
Stage 1	-	-	-	-	-	-
Stage 2	-	-	-	-	-	-
Critical Hdwy	-	-	-	-	-	6.22
Critical Hdwy Stg 1	-	-	-	-	-	-
Critical Hdwy Stg 2	-	-	-	-	-	-
Follow-up Hdwy	-	-	-	-	-	3.318
Pot Cap-1 Maneuver	-	-	0	-	0	648
Stage 1	-	-	0	-	0	-
Stage 2	-	-	0	-	0	-
Platoon blocked, %	-	-	-	-	-	-
Mov Cap-1 Maneuver	-	-	-	-	-	648
Mov Cap-2 Maneuver	-	-	-	-	-	-
Stage 1	-	-	-	-	-	-
Stage 2	-	-	-	-	-	-
Approach	EB	WB	NB			
HCM Control Delay, s	0	0	10.8			
HCM LOS				B		
Minor Lane/Major Mvmt	NBLn1	EBT	EBR	WBT		
Capacity (veh/h)	648	-	-	-		
HCM Lane V/C Ratio	0.045	-	-	-		
HCM Control Delay (s)	10.8	-	-	-		
HCM Lane LOS	B	-	-	-		
HCM 95th %tile Q(veh)	0.1	-	-	-		

8: Driveway C & Paradise Lane

08/18/2022

Intersection												
Int Delay, s/veh	3.5											
Movement	EBL	EBT	EBR	WBL	WBT	WBR	NBL	NBT	NBR	SBL	SBT	SBR
Lane Configurations												
Traffic Vol, veh/h	32	258	26	29	173	18	59	0	36	16	0	34
Future Vol, veh/h	32	258	26	29	173	18	59	0	36	16	0	34
Conflicting Peds, #/hr	0	0	0	0	0	0	0	0	0	0	0	0
Sign Control	Free	Free	Free	Free	Free	Free	Stop	Stop	Stop	Stop	Stop	Stop
RT Channelized	-	-	None	-	-	None	-	-	None	-	-	None
Storage Length	100	-	-	100	-	-	-	-	-	-	-	-
Veh in Median Storage, #	-	0	-	-	0	-	-	0	-	-	0	-
Grade, %	-	0	-	-	0	-	-	0	-	-	0	-
Peak Hour Factor	92	92	92	92	92	92	92	92	92	92	92	92
Heavy Vehicles, %	2	2	2	2	2	2	2	2	2	2	2	2
Mvmt Flow	35	280	28	32	188	20	64	0	39	17	0	37

Major/Minor	Major1			Major2			Minor1			Minor2		
Conflicting Flow All	208	0	0	308	0	0	645	636	294	646	640	198
Stage 1	-	-	-	-	-	-	364	364	-	262	262	-
Stage 2	-	-	-	-	-	-	281	272	-	384	378	-
Critical Hdwy	4.12	-	-	4.12	-	-	7.12	6.52	6.22	7.12	6.52	6.22
Critical Hdwy Stg 1	-	-	-	-	-	-	6.12	5.52	-	6.12	5.52	-
Critical Hdwy Stg 2	-	-	-	-	-	-	6.12	5.52	-	6.12	5.52	-
Follow-up Hdwy	2.218	-	-	2.218	-	-	3.518	4.018	3.318	3.518	4.018	3.318
Pot Cap-1 Maneuver	1363	-	-	1286	-	-	426	418	871	425	416	843
Stage 1	-	-	-	-	-	-	739	661	-	743	691	-
Stage 2	-	-	-	-	-	-	726	685	-	718	650	-
Platoon blocked, %		-	-	1	-	-	1	1	1	1	1	
Mov Cap-1 Maneuver	1363	-	-	1286	-	-	392	397	871	390	395	843
Mov Cap-2 Maneuver	-	-	-	-	-	-	392	397	-	390	395	-
Stage 1	-	-	-	-	-	-	720	644	-	724	674	-
Stage 2	-	-	-	-	-	-	677	668	-	668	633	-

Approach	EB	WB	NB	SB
HCM Control Delay, s	0.8	1	14.2	11.4
HCM LOS			B	B

Minor Lane/Major Mvmt	NBLn1	EBL	EBT	EBR	WBL	WBT	WBR	SBLn1
Capacity (veh/h)	495	1363	-	-	1286	-	-	615
HCM Lane V/C Ratio	0.209	0.026	-	-	0.025	-	-	0.088
HCM Control Delay (s)	14.2	7.7	-	-	7.9	-	-	11.4
HCM Lane LOS	B	A	-	-	A	-	-	B
HCM 95th %tile Q(veh)	0.8	0.1	-	-	0.1	-	-	0.3

Intersection						
Int Delay, s/veh	4.3					
Movement	EBT	EBR	WBL	WBT	NBL	NBR
Lane Configurations						
Traffic Vol, veh/h	221	88	45	129	96	158
Future Vol, veh/h	221	88	45	129	96	158
Conflicting Peds, #/hr	0	0	0	0	0	0
Sign Control	Free	Free	Free	Free	Stop	Stop
RT Channelized	-	None	-	None	-	None
Storage Length	-	-	100	-	80	0
Veh in Median Storage, #	0	-	-	0	0	-
Grade, %	0	-	-	0	0	-
Peak Hour Factor	92	92	92	92	92	92
Heavy Vehicles, %	2	2	2	2	2	2
Mvmt Flow	240	96	49	140	104	172

Major/Minor	Major1	Major2	Minor1		
Conflicting Flow All	0	0	336	0	526 288
Stage 1	-	-	-	-	288 -
Stage 2	-	-	-	-	238 -
Critical Hdwy	-	-	4.12	-	6.42 6.22
Critical Hdwy Stg 1	-	-	-	-	5.42 -
Critical Hdwy Stg 2	-	-	-	-	5.42 -
Follow-up Hdwy	-	-	2.218	-	3.518 3.318
Pot Cap-1 Maneuver	-	-	1236	-	546 838
Stage 1	-	-	-	-	806 -
Stage 2	-	-	-	-	802 -
Platoon blocked, %	-	-	1	-	1 1
Mov Cap-1 Maneuver	-	-	1236	-	524 838
Mov Cap-2 Maneuver	-	-	-	-	598 -
Stage 1	-	-	-	-	806 -
Stage 2	-	-	-	-	770 -

Approach	EB	WB	NB
HCM Control Delay, s	0	2.1	11.1
HCM LOS			B

Minor Lane/Major Mvmt	NBLn1	NBLn2	EBT	EBR	WBL	WBT
Capacity (veh/h)	598	838	-	-	1236	-
HCM Lane V/C Ratio	0.174	0.205	-	-	0.04	-
HCM Control Delay (s)	12.3	10.4	-	-	8	-
HCM Lane LOS	B	B	-	-	A	-
HCM 95th %tile Q(veh)	0.6	0.8	-	-	0.1	-

Intersection						
Int Delay, s/veh	2.6					
Movement	EBL	EBR	NBL	NBT	SBT	SBR
Lane Configurations						
Traffic Vol, veh/h	65	35	14	206	116	33
Future Vol, veh/h	65	35	14	206	116	33
Conflicting Peds, #/hr	0	0	0	0	0	0
Sign Control	Stop	Stop	Free	Free	Free	Free
RT Channelized	-	None	-	None	-	None
Storage Length	0	-	100	-	-	-
Veh in Median Storage, #	0	-	-	0	0	-
Grade, %	0	-	-	0	0	-
Peak Hour Factor	92	92	92	92	92	92
Heavy Vehicles, %	2	2	2	2	2	2
Mvmt Flow	71	38	15	224	126	36

Major/Minor	Minor2	Major1	Major2			
Conflicting Flow All	398	144	162	0	-	0
Stage 1	144	-	-	-	-	-
Stage 2	254	-	-	-	-	-
Critical Hdwy	6.42	6.22	4.12	-	-	-
Critical Hdwy Stg 1	5.42	-	-	-	-	-
Critical Hdwy Stg 2	5.42	-	-	-	-	-
Follow-up Hdwy	3.518	3.318	2.218	-	-	-
Pot Cap-1 Maneuver	607	903	1417	-	-	-
Stage 1	883	-	-	-	-	-
Stage 2	788	-	-	-	-	-
Platoon blocked, %				-	-	-
Mov Cap-1 Maneuver	600	903	1417	-	-	-
Mov Cap-2 Maneuver	649	-	-	-	-	-
Stage 1	873	-	-	-	-	-
Stage 2	788	-	-	-	-	-

Approach	EB	NB	SB
HCM Control Delay, s	10.9	0.5	0
HCM LOS	B		

Minor Lane/Major Mvmt	NBL	NBT	EBLn1	SBT	SBR
Capacity (veh/h)	1417	-	720	-	-
HCM Lane V/C Ratio	0.011	-	0.151	-	-
HCM Control Delay (s)	7.6	-	10.9	-	-
HCM Lane LOS	A	-	B	-	-
HCM 95th %tile Q(veh)	0	-	0.5	-	-

Intersection						
Int Delay, s/veh	1					
Movement	WBL	WBR	NBT	NBR	SBL	SBT
Lane Configurations						
Traffic Vol, veh/h	7	10	188	33	27	111
Future Vol, veh/h	7	10	188	33	27	111
Conflicting Peds, #/hr	0	0	0	0	0	0
Sign Control	Stop	Stop	Free	Free	Free	Free
RT Channelized	-	None	-	None	-	None
Storage Length	75	0	-	-	100	-
Veh in Median Storage, #	0	-	0	-	-	0
Grade, %	0	-	0	-	-	0
Peak Hour Factor	92	92	92	92	92	92
Heavy Vehicles, %	2	2	2	2	2	2
Mvmt Flow	8	11	204	36	29	121

Major/Minor	Minor1	Major1	Major2		
Conflicting Flow All	401	222	0	0	240
Stage 1	222	-	-	-	-
Stage 2	179	-	-	-	-
Critical Hdwy	6.42	6.22	-	-	4.12
Critical Hdwy Stg 1	5.42	-	-	-	-
Critical Hdwy Stg 2	5.42	-	-	-	-
Follow-up Hdwy	3.518	3.318	-	-	2.218
Pot Cap-1 Maneuver	605	818	-	-	1327
Stage 1	815	-	-	-	-
Stage 2	852	-	-	-	-
Platoon blocked, %			-	-	-
Mov Cap-1 Maneuver	592	818	-	-	1327
Mov Cap-2 Maneuver	646	-	-	-	-
Stage 1	815	-	-	-	-
Stage 2	833	-	-	-	-

Approach	WB	NB	SB
HCM Control Delay, s	10	0	1.5
HCM LOS	B		

Minor Lane/Major Mvmt	NBT	NBR	WBLn1	WBLn2	SBL	SBT
Capacity (veh/h)	-	-	646	818	1327	-
HCM Lane V/C Ratio	-	-	0.012	0.013	0.022	-
HCM Control Delay (s)	-	-	10.6	9.5	7.8	-
HCM Lane LOS	-	-	B	A	A	-
HCM 95th %tile Q(veh)	-	-	0	0	0.1	-

Intersection												
Int Delay, s/veh	4.4											
Movement	EBL	EBT	EBR	WBL	WBT	WBR	NBL	NBT	NBR	SBL	SBT	SBR
Lane Configurations		↕			↕		↕	↕		↕	↕	
Traffic Vol, veh/h	105	0	25	0	0	0	25	121	2	1	103	14
Future Vol, veh/h	105	0	25	0	0	0	25	121	2	1	103	14
Conflicting Peds, #/hr	0	0	0	0	0	0	0	0	0	0	0	0
Sign Control	Stop	Stop	Stop	Stop	Stop	Stop	Free	Free	Free	Free	Free	Free
RT Channelized	-	-	None	-	-	None	-	-	None	-	-	None
Storage Length	-	-	-	-	-	-	100	-	-	100	-	-
Veh in Median Storage, #	-	0	-	-	0	-	-	0	-	-	0	-
Grade, %	-	0	-	-	0	-	-	0	-	-	0	-
Peak Hour Factor	92	92	92	92	92	92	92	92	92	92	92	92
Heavy Vehicles, %	2	2	2	2	2	2	2	2	2	2	2	2
Mvmt Flow	114	0	27	0	0	0	27	132	2	1	112	15

Major/Minor	Minor2		Minor1		Major1		Major2					
Conflicting Flow All	309	310	120	322	316	133	127	0	0	134	0	0
Stage 1	122	122	-	187	187	-	-	-	-	-	-	-
Stage 2	187	188	-	135	129	-	-	-	-	-	-	-
Critical Hdwy	7.12	6.52	6.22	7.12	6.52	6.22	4.12	-	-	4.12	-	-
Critical Hdwy Stg 1	6.12	5.52	-	6.12	5.52	-	-	-	-	-	-	-
Critical Hdwy Stg 2	6.12	5.52	-	6.12	5.52	-	-	-	-	-	-	-
Follow-up Hdwy	3.518	4.018	3.318	3.518	4.018	3.318	2.218	-	-	2.218	-	-
Pot Cap-1 Maneuver	643	605	931	631	600	916	1459	-	-	1451	-	-
Stage 1	882	795	-	815	745	-	-	-	-	-	-	-
Stage 2	815	745	-	868	789	-	-	-	-	-	-	-
Platoon blocked, %								-	-	-	-	-
Mov Cap-1 Maneuver	633	593	931	604	588	916	1459	-	-	1451	-	-
Mov Cap-2 Maneuver	633	593	-	604	588	-	-	-	-	-	-	-
Stage 1	865	794	-	800	731	-	-	-	-	-	-	-
Stage 2	800	731	-	842	788	-	-	-	-	-	-	-

Approach	EB		WB		NB		SB	
HCM Control Delay, s	11.7		0		1.3		0.1	
HCM LOS	B		A					

Minor Lane/Major Mvmt	NBL	NBT	NBR	EBLn1WBLn1	SBL	SBT	SBR
Capacity (veh/h)	1459	-	-	675	-	1451	-
HCM Lane V/C Ratio	0.019	-	-	0.209	-	0.001	-
HCM Control Delay (s)	7.5	-	-	11.7	0	7.5	-
HCM Lane LOS	A	-	-	B	A	A	-
HCM 95th %tile Q(veh)	0.1	-	-	0.8	-	0	-

Intersection												
Int Delay, s/veh	2.9											
Movement	EBL	EBT	EBR	WBL	WBT	WBR	NBL	NBT	NBR	SBL	SBT	SBR
Lane Configurations	↶	↷		↶	↷			↕			↕	
Traffic Vol, veh/h	45	157	7	0	167	33	11	0	12	6	0	81
Future Vol, veh/h	45	157	7	0	167	33	11	0	12	6	0	81
Conflicting Peds, #/hr	0	0	0	0	0	0	0	0	0	0	0	0
Sign Control	Free	Free	Free	Free	Free	Free	Stop	Stop	Stop	Stop	Stop	Stop
RT Channelized	-	-	None	-	-	None	-	-	None	-	-	None
Storage Length	100	-	-	100	-	-	-	-	-	-	-	-
Veh in Median Storage, #	-	0	-	-	0	-	-	0	-	-	0	-
Grade, %	-	0	-	-	0	-	-	0	-	-	0	-
Peak Hour Factor	92	92	92	92	92	92	92	92	92	92	92	92
Heavy Vehicles, %	2	2	2	2	2	2	2	2	2	2	2	2
Mvmt Flow	49	171	8	0	182	36	12	0	13	7	0	88

Major/Minor	Major1			Major2			Minor1			Minor2		
Conflicting Flow All	218	0	0	179	0	0	517	491	175	480	477	200
Stage 1	-	-	-	-	-	-	273	273	-	200	200	-
Stage 2	-	-	-	-	-	-	244	218	-	280	277	-
Critical Hdwy	4.12	-	-	4.12	-	-	7.12	6.52	6.22	7.12	6.52	6.22
Critical Hdwy Stg 1	-	-	-	-	-	-	6.12	5.52	-	6.12	5.52	-
Critical Hdwy Stg 2	-	-	-	-	-	-	6.12	5.52	-	6.12	5.52	-
Follow-up Hdwy	2.218	-	-	2.218	-	-	3.518	4.018	3.318	3.518	4.018	3.318
Pot Cap-1 Maneuver	1352	-	-	1423	-	-	500	499	945	532	509	841
Stage 1	-	-	-	-	-	-	782	706	-	802	736	-
Stage 2	-	-	-	-	-	-	760	723	-	774	703	-
Platoon blocked, %		-	-	1	-	-	1	1	1	1	1	
Mov Cap-1 Maneuver	1352	-	-	1423	-	-	435	481	945	510	490	841
Mov Cap-2 Maneuver	-	-	-	-	-	-	435	481	-	510	490	-
Stage 1	-	-	-	-	-	-	754	680	-	773	736	-
Stage 2	-	-	-	-	-	-	680	723	-	736	678	-

Approach	EB			WB			NB			SB		
HCM Control Delay, s	1.7			0			11.2			10.1		
HCM LOS							B			B		

Minor Lane/Major Mvmt	NBLn1	EBL	EBT	EBR	WBL	WBT	WBR	SBLn1
Capacity (veh/h)	605	1352	-	-	1423	-	-	805
HCM Lane V/C Ratio	0.041	0.036	-	-	-	-	-	0.117
HCM Control Delay (s)	11.2	7.8	-	-	0	-	-	10.1
HCM Lane LOS	B	A	-	-	A	-	-	B
HCM 95th %tile Q(veh)	0.1	0.1	-	-	0	-	-	0.4

Intersection	
Intersection Delay, s/veh	9.1
Intersection LOS	A

Movement	EBL	EBT	EBR	WBL	WBT	WBR	NBL	NBT	NBR	SBL	SBT	SBR
Lane Configurations	↶	↷		↶	↷		↶	↷		↶	↷	
Traffic Vol, veh/h	79	62	50	33	54	7	65	57	15	6	69	49
Future Vol, veh/h	79	62	50	33	54	7	65	57	15	6	69	49
Peak Hour Factor	0.92	0.92	0.92	0.92	0.92	0.92	0.92	0.92	0.92	0.92	0.92	0.92
Heavy Vehicles, %	2	2	2	2	2	2	2	2	2	2	2	2
Mvmt Flow	86	67	54	36	59	8	71	62	16	7	75	53
Number of Lanes	1	1	0	1	1	0	1	1	0	1	1	0

Approach	EB	WB	NB	SB
Opposing Approach	WB	EB	SB	NB
Opposing Lanes	2	2	2	2
Conflicting Approach Left	SB	NB	EB	WB
Conflicting Lanes Left	2	2	2	2
Conflicting Approach Right	NB	SB	WB	EB
Conflicting Lanes Right	2	2	2	2
HCM Control Delay	9.2	8.9	9.2	9.2
HCM LOS	A	A	A	A

Lane	NBLn1	NBLn2	EBLn1	EBLn2	WBLn1	WBLn2	SBLn1	SBLn2
Vol Left, %	100%	0%	100%	0%	100%	0%	100%	0%
Vol Thru, %	0%	79%	0%	55%	0%	89%	0%	58%
Vol Right, %	0%	21%	0%	45%	0%	11%	0%	42%
Sign Control	Stop	Stop	Stop	Stop	Stop	Stop	Stop	Stop
Traffic Vol by Lane	65	72	79	112	33	61	6	118
LT Vol	65	0	79	0	33	0	6	0
Through Vol	0	57	0	62	0	54	0	69
RT Vol	0	15	0	50	0	7	0	49
Lane Flow Rate	71	78	86	122	36	66	7	128
Geometry Grp	7	7	7	7	7	7	7	7
Degree of Util (X)	0.117	0.116	0.141	0.172	0.06	0.1	0.011	0.186
Departure Headway (Hd)	5.987	5.337	5.894	5.076	6.014	5.43	6.018	5.221
Convergence, Y/N	Yes	Yes	Yes	Yes	Yes	Yes	Yes	Yes
Cap	596	668	606	702	592	656	592	682
Service Time	3.753	3.102	3.655	2.836	3.784	3.199	3.783	2.986
HCM Lane V/C Ratio	0.119	0.117	0.142	0.174	0.061	0.101	0.012	0.188
HCM Control Delay	9.6	8.8	9.6	8.9	9.2	8.8	8.9	9.2
HCM Lane LOS	A	A	A	A	A	A	A	A
HCM 95th-tile Q	0.4	0.4	0.5	0.6	0.2	0.3	0	0.7

15: 73rd Street/Dial Boulevard & Greenway Hayden Loop

08/18/2022

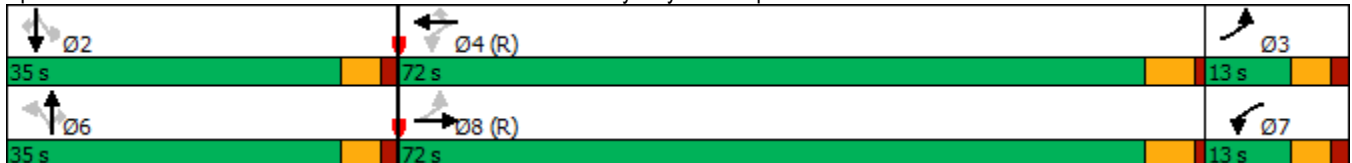


Lane Group	EBL	EBT	WBL	WBT	WBR	NBL	NBT	NBR	SBL	SBT	SBR
Lane Configurations	↘	↗↗↗	↘	↗↗	↗	↘	↗	↗	↘	↗	↗
Traffic Volume (vph)	33	551	214	444	77	39	59	245	87	62	108
Future Volume (vph)	33	551	214	444	77	39	59	245	87	62	108
Turn Type	pm+pt	NA	pm+pt	NA	Perm	Perm	NA	Perm	Perm	NA	Perm
Protected Phases	3	8	7	4			6			2	
Permitted Phases	8		4		4	6		6	2		2
Detector Phase	3	8	7	4	4	6	6	6	2	2	2
Switch Phase											
Minimum Initial (s)	5.0	10.0	5.0	10.0	10.0	7.0	7.0	7.0	7.0	7.0	7.0
Minimum Split (s)	12.0	37.0	37.0	36.0	36.0	37.0	37.0	37.0	37.0	37.0	37.0
Total Split (s)	13.0	72.0	13.0	72.0	72.0	35.0	35.0	35.0	35.0	35.0	35.0
Total Split (%)	10.8%	60.0%	10.8%	60.0%	60.0%	29.2%	29.2%	29.2%	29.2%	29.2%	29.2%
Yellow Time (s)	3.6	4.4	3.6	4.4	4.4	3.6	3.6	3.6	3.6	3.6	3.6
All-Red Time (s)	1.7	1.0	1.7	1.0	1.0	1.6	1.6	1.6	1.6	1.6	1.6
Lost Time Adjust (s)	0.0	0.0	0.0	0.0	0.0	0.0	0.0	0.0	0.0	0.0	0.0
Total Lost Time (s)	5.3	5.4	5.3	5.4	5.4	5.2	5.2	5.2	5.2	5.2	5.2
Lead/Lag	Lag	Lead	Lag	Lead	Lead						
Lead-Lag Optimize?	Yes	Yes	Yes	Yes	Yes						
Recall Mode	Max	C-Min	None	C-Min	C-Min	None	None	None	None	None	None
Act Effct Green (s)	90.6	35.6	91.8	36.2	36.2	13.0	13.0	13.0	13.0	13.0	13.0
Actuated g/C Ratio	0.76	0.30	0.76	0.30	0.30	0.11	0.11	0.11	0.11	0.11	0.11
v/c Ratio	0.04	0.44	0.23	0.45	0.16	0.29	0.32	0.65	0.66	0.33	0.43
Control Delay	3.7	29.6	4.4	30.7	5.4	52.5	51.8	13.5	71.6	52.3	13.0
Queue Delay	0.0	0.0	0.0	0.0	0.0	0.0	0.0	0.0	0.0	0.0	0.0
Total Delay	3.7	29.6	4.4	30.7	5.4	52.5	51.8	13.5	71.6	52.3	13.0
LOS	A	C	A	C	A	D	D	B	E	D	B
Approach Delay		28.3		20.4			24.5			42.4	
Approach LOS		C		C			C			D	

Intersection Summary

Cycle Length: 120
 Actuated Cycle Length: 120
 Offset: 47 (39%), Referenced to phase 4:WBTL and 8:EBTL, Start of Green
 Natural Cycle: 115
 Control Type: Actuated-Coordinated
 Maximum v/c Ratio: 0.66
 Intersection Signal Delay: 26.5
 Intersection Capacity Utilization 48.4%
 Analysis Period (min) 15
 Intersection LOS: C
 ICU Level of Service A

Splits and Phases: 15: 73rd Street/Dial Boulevard & Greenway Hayden Loop



15: 73rd Street/Dial Boulevard & Greenway Hayden Loop

08/18/2022



Movement	EBL	EBT	EBR	WBL	WBT	WBR	NBL	NBT	NBR	SBL	SBT	SBR
Lane Configurations	↖	↕↕↕		↖	↕↕	↖	↖	↕	↖	↖	↕	↖
Traffic Volume (veh/h)	33	551	52	214	444	77	39	59	245	87	62	108
Future Volume (veh/h)	33	551	52	214	444	77	39	59	245	87	62	108
Initial Q (Qb), veh	0	0	0	0	0	0	0	0	0	0	0	0
Ped-Bike Adj(A_pbT)	1.00		1.00	1.00		1.00	1.00		1.00	1.00		1.00
Parking Bus, Adj	1.00	1.00	1.00	1.00	1.00	1.00	1.00	1.00	1.00	1.00	1.00	1.00
Work Zone On Approach		No			No			No			No	
Adj Sat Flow, veh/h/ln	1870	1870	1870	1870	1870	1870	1870	1870	1870	1870	1870	1870
Adj Flow Rate, veh/h	36	599	57	233	483	84	42	64	266	95	67	117
Peak Hour Factor	0.92	0.92	0.92	0.92	0.92	0.92	0.92	0.92	0.92	0.92	0.92	0.92
Percent Heavy Veh, %	2	2	2	2	2	2	2	2	2	2	2	2
Cap, veh/h	1007	797	75	1009	597	266	246	347	294	224	347	294
Arrive On Green	0.17	0.06	0.06	0.51	0.17	0.17	0.19	0.19	0.19	0.19	0.19	0.19
Sat Flow, veh/h	1781	4746	447	1781	3554	1585	1200	1870	1585	1050	1870	1585
Grp Volume(v), veh/h	36	428	228	233	483	84	42	64	266	95	67	117
Grp Sat Flow(s),veh/h/ln	1781	1702	1790	1781	1777	1585	1200	1870	1585	1050	1870	1585
Q Serve(g_s), s	0.0	14.9	15.1	1.6	15.7	5.6	3.7	3.5	19.7	10.1	3.6	7.8
Cycle Q Clear(g_c), s	0.0	14.9	15.1	1.6	15.7	5.6	7.3	3.5	19.7	13.5	3.6	7.8
Prop In Lane	1.00		0.25	1.00		1.00	1.00		1.00	1.00		1.00
Lane Grp Cap(c), veh/h	1007	571	300	1009	597	266	246	347	294	224	347	294
V/C Ratio(X)	0.04	0.75	0.76	0.23	0.81	0.32	0.17	0.18	0.91	0.42	0.19	0.40
Avail Cap(c_a), veh/h	1007	1889	993	1009	1972	880	322	464	394	290	464	394
HCM Platoon Ratio	0.33	0.33	0.33	1.00	1.00	1.00	1.00	1.00	1.00	1.00	1.00	1.00
Upstream Filter(I)	0.87	0.87	0.87	1.00	1.00	1.00	1.00	1.00	1.00	1.00	1.00	1.00
Uniform Delay (d), s/veh	22.3	54.2	54.3	13.9	48.1	43.9	44.4	41.2	47.8	46.9	41.3	43.0
Incr Delay (d2), s/veh	0.1	7.7	14.5	0.0	11.3	3.1	0.1	0.1	16.9	0.5	0.1	0.3
Initial Q Delay(d3),s/veh	0.0	0.0	0.0	0.0	0.0	0.0	0.0	0.0	0.0	0.0	0.0	0.0
%ile BackOfQ(50%),veh/ln	0.8	7.4	8.5	3.1	7.9	2.4	1.1	1.6	9.1	2.7	1.7	3.1
Unsig. Movement Delay, s/veh												
LnGrp Delay(d),s/veh	22.3	61.8	68.8	13.9	59.4	47.0	44.5	41.3	64.7	47.4	41.4	43.3
LnGrp LOS	C	E	E	B	E	D	D	D	E	D	D	D
Approach Vol, veh/h		692			800			372			279	
Approach Delay, s/veh		62.1			44.8			58.4			44.2	
Approach LOS		E			D			E			D	
Timer - Assigned Phs		2	3	4		6	7	8				
Phs Duration (G+Y+Rc), s		27.5	67.0	25.5		27.5	67.0	25.5				
Change Period (Y+Rc), s		* 5.2	5.3	* 5.4		* 5.2	5.3	* 5.4				
Max Green Setting (Gmax), s		* 30	7.7	* 67		* 30	7.7	* 67				
Max Q Clear Time (g_c+I1), s		15.5	2.0	17.7		21.7	3.6	17.1				
Green Ext Time (p_c), s		0.6	0.0	2.4		0.5	0.1	3.1				

Intersection Summary

HCM 6th Ctrl Delay	52.7
HCM 6th LOS	D

Notes

User approved pedestrian interval to be less than phase max green.
 * HCM 6th computational engine requires equal clearance times for the phases crossing the barrier.

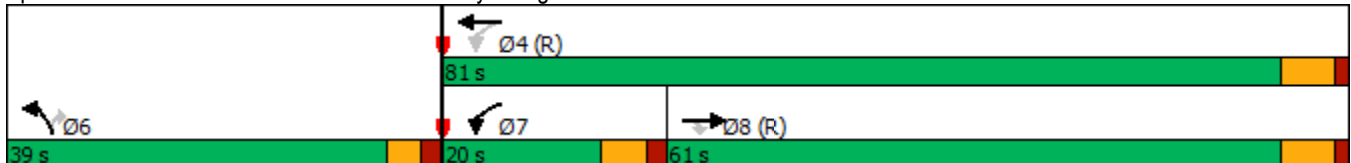


Lane Group	EBT	EBR	WBL	WBT	NBL	NBR
Lane Configurations	↑↑↑	↑	↓	↑↑↑	↓	↓
Traffic Volume (vph)	1542	106	233	933	48	233
Future Volume (vph)	1542	106	233	933	48	233
Turn Type	NA	Perm	pm+pt	NA	Prot	Perm
Protected Phases	8		7	4	6	
Permitted Phases		8	4			6
Detector Phase	8	8	7	4	6	6
Switch Phase						
Minimum Initial (s)	7.0	7.0	5.0	10.0	7.0	7.0
Minimum Split (s)	13.2	13.2	11.0	16.2	12.0	12.0
Total Split (s)	61.0	61.0	20.0	81.0	39.0	39.0
Total Split (%)	50.8%	50.8%	16.7%	67.5%	32.5%	32.5%
Yellow Time (s)	4.7	4.7	4.0	4.7	3.0	3.0
All-Red Time (s)	1.5	1.5	1.9	1.5	2.0	2.0
Lost Time Adjust (s)	0.0	0.0	0.0	0.0	0.0	0.0
Total Lost Time (s)	6.2	6.2	5.9	6.2	5.0	5.0
Lead/Lag	Lag	Lag	Lead			
Lead-Lag Optimize?	Yes	Yes	Yes			
Recall Mode	C-Min	C-Min	None	C-Min	None	None
Act Effct Green (s)	77.3	77.3	99.5	99.2	9.6	9.6
Actuated g/C Ratio	0.64	0.64	0.83	0.83	0.08	0.08
v/c Ratio	0.51	0.11	0.70	0.24	0.19	0.75
Control Delay	8.7	4.3	33.4	0.5	51.4	23.6
Queue Delay	0.0	0.0	0.0	0.0	0.0	0.0
Total Delay	8.7	4.3	33.4	0.5	51.4	23.6
LOS	A	A	C	A	D	C
Approach Delay	8.4			7.1	28.3	
Approach LOS	A			A	C	

Intersection Summary

Cycle Length: 120
 Actuated Cycle Length: 120
 Offset: 75 (63%), Referenced to phase 4:WBTL and 8:EBT, Start of 1st Green
 Natural Cycle: 60
 Control Type: Actuated-Coordinated
 Maximum v/c Ratio: 0.75
 Intersection Signal Delay: 9.7
 Intersection Capacity Utilization 62.8%
 Analysis Period (min) 15
 Intersection LOS: A
 ICU Level of Service B

Splits and Phases: 16: 76th Street & Frank Lloyd Wright Boulevard



16: 76th Street & Frank Lloyd Wright Boulevard

08/18/2022



Movement	EBT	EBR	WBL	WBT	NBL	NBR	
Lane Configurations	↑↑↑	↗	↖	↑↑↑	↖	↗	
Traffic Volume (veh/h)	1542	106	233	933	48	233	
Future Volume (veh/h)	1542	106	233	933	48	233	
Initial Q (Qb), veh	0	0	0	0	0	0	
Ped-Bike Adj(A_pbT)		1.00	1.00		1.00	1.00	
Parking Bus, Adj	1.00	1.00	1.00	1.00	1.00	1.00	
Work Zone On Approach	No			No	No		
Adj Sat Flow, veh/h/ln	1870	1870	1870	1870	1870	1870	
Adj Flow Rate, veh/h	1676	115	253	1014	52	253	
Peak Hour Factor	0.92	0.92	0.92	0.92	0.92	0.92	
Percent Heavy Veh, %	2	2	2	2	2	2	
Cap, veh/h	3096	961	275	3726	612	280	
Arrive On Green	0.20	0.20	0.15	1.00	0.18	0.18	
Sat Flow, veh/h	5274	1585	1781	5274	3456	1585	
Grp Volume(v), veh/h	1676	115	253	1014	52	253	
Grp Sat Flow(s),veh/h/ln	1702	1585	1781	1702	1728	1585	
Q Serve(g_s), s	35.3	7.1	6.9	0.0	1.5	18.8	
Cycle Q Clear(g_c), s	35.3	7.1	6.9	0.0	1.5	18.8	
Prop In Lane		1.00	1.00		1.00	1.00	
Lane Grp Cap(c), veh/h	3096	961	275	3726	612	280	
V/C Ratio(X)	0.54	0.12	0.92	0.27	0.09	0.90	
Avail Cap(c_a), veh/h	3096	961	352	3726	979	449	
HCM Platoon Ratio	0.33	0.33	2.00	2.00	1.00	1.00	
Upstream Filter(I)	0.52	0.52	0.85	0.85	1.00	1.00	
Uniform Delay (d), s/veh	33.0	21.8	21.8	0.0	41.3	48.4	
Incr Delay (d2), s/veh	0.4	0.1	20.1	0.2	0.0	9.6	
Initial Q Delay(d3),s/veh	0.0	0.0	0.0	0.0	0.0	0.0	
%ile BackOfQ(50%),veh/ln	16.1	2.7	5.5	0.1	0.7	16.1	
Unsig. Movement Delay, s/veh							
LnGrp Delay(d),s/veh	33.4	21.9	41.9	0.2	41.3	57.9	
LnGrp LOS	C	C	D	A	D	E	
Approach Vol, veh/h	1791			1267	305		
Approach Delay, s/veh	32.6			8.5	55.1		
Approach LOS	C			A	E		
Timer - Assigned Phs				4	6	7	8
Phs Duration (G+Y+Rc), s				93.8	26.2	14.8	79.0
Change Period (Y+Rc), s				6.2	5.0	* 5.9	6.2
Max Green Setting (Gmax), s				74.8	34.0	* 14	54.8
Max Q Clear Time (g_c+I1), s				2.0	20.8	8.9	37.3
Green Ext Time (p_c), s				1.2	0.5	0.0	2.2

Intersection Summary

HCM 6th Ctrl Delay	25.6
HCM 6th LOS	C

Notes

User approved pedestrian interval to be less than phase max green.

* HCM 6th computational engine requires equal clearance times for the phases crossing the barrier.

Intersection

Intersection Delay, s/veh 11
 Intersection LOS B

Movement	EBL	EBT	EBR	WBL	WBT	WBR	NBL	NBT	NBR	SBL	SBT	SBR
Lane Configurations												
Traffic Vol, veh/h	145	161	49	21	80	24	4	72	10	32	126	69
Future Vol, veh/h	145	161	49	21	80	24	4	72	10	32	126	69
Peak Hour Factor	0.92	0.92	0.92	0.92	0.92	0.92	0.92	0.92	0.92	0.92	0.92	0.92
Heavy Vehicles, %	2	2	2	2	2	2	2	2	2	2	2	2
Mvmt Flow	158	175	53	23	87	26	4	78	11	35	137	75
Number of Lanes	1	1	0	1	1	0	1	1	0	1	1	0

Approach	EB	WB	NB	SB
Opposing Approach	WB	EB	SB	NB
Opposing Lanes	2	2	2	2
Conflicting Approach Left	SB	NB	EB	WB
Conflicting Lanes Left	2	2	2	2
Conflicting Approach Right	NB	SB	WB	EB
Conflicting Lanes Right	2	2	2	2
HCM Control Delay	11.4	10	10.2	11.4
HCM LOS	B	A	B	B

Lane	NBLn1	NBLn2	EBLn1	EBLn2	WBLn1	WBLn2	SBLn1	SBLn2
Vol Left, %	100%	0%	100%	0%	100%	0%	100%	0%
Vol Thru, %	0%	88%	0%	77%	0%	77%	0%	65%
Vol Right, %	0%	12%	0%	23%	0%	23%	0%	35%
Sign Control	Stop	Stop	Stop	Stop	Stop	Stop	Stop	Stop
Traffic Vol by Lane	4	82	145	210	21	104	32	195
LT Vol	4	0	145	0	21	0	32	0
Through Vol	0	72	0	161	0	80	0	126
RT Vol	0	10	0	49	0	24	0	69
Lane Flow Rate	4	89	158	228	23	113	35	212
Geometry Grp	7	7	7	7	7	7	7	7
Degree of Util (X)	0.008	0.156	0.274	0.355	0.042	0.187	0.064	0.346
Departure Headway (Hd)	6.876	6.282	6.262	5.592	6.614	5.943	6.628	5.871
Convergence, Y/N	Yes	Yes	Yes	Yes	Yes	Yes	Yes	Yes
Cap	521	570	575	644	541	604	541	613
Service Time	4.617	4.023	3.992	3.322	4.352	3.681	4.362	3.605
HCM Lane V/C Ratio	0.008	0.156	0.275	0.354	0.043	0.187	0.065	0.346
HCM Control Delay	9.7	10.2	11.3	11.4	9.6	10.1	9.8	11.7
HCM Lane LOS	A	B	B	B	A	B	A	B
HCM 95th-tile Q	0	0.5	1.1	1.6	0.1	0.7	0.2	1.5

18: Greenway Hayden Loop & Frank Lloyd Wright Boulevard

08/18/2022

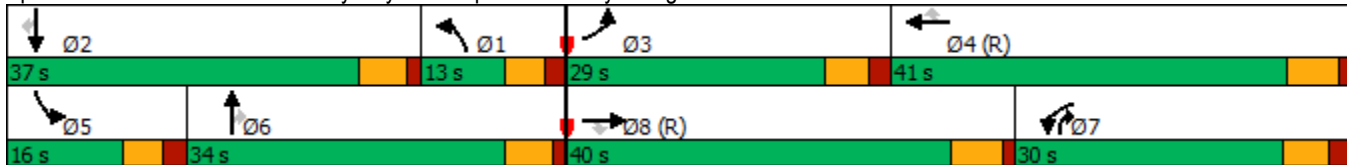


Lane Group	EBL	EBT	EBR	WBL	WBT	WBR	NBL	NBT	NBR	SBL	SBT	SBR
Lane Configurations	↖↖	↑↑↑	↗	↖↖	↑↑↑	↗	↖	↑↑	↗	↖↖	↑↑	↗
Traffic Volume (vph)	335	1320	62	638	1004	172	13	416	429	240	630	297
Future Volume (vph)	335	1320	62	638	1004	172	13	416	429	240	630	297
Turn Type	Prot	NA	Perm	Prot	NA	Perm	Prot	NA	pm+ov	Prot	NA	Perm
Protected Phases	3	8		7	4		1	6	7	5	2	
Permitted Phases			8			4			6			2
Detector Phase	3	8	8	7	4	4	1	6	7	5	2	2
Switch Phase												
Minimum Initial (s)	5.0	10.0	10.0	5.0	10.0	10.0	5.0	7.0	5.0	5.0	7.0	7.0
Minimum Split (s)	11.0	15.9	15.9	11.0	15.9	15.9	11.0	13.0	11.0	11.0	13.0	13.0
Total Split (s)	29.0	40.0	40.0	30.0	41.0	41.0	13.0	34.0	30.0	16.0	37.0	37.0
Total Split (%)	24.2%	33.3%	33.3%	25.0%	34.2%	34.2%	10.8%	28.3%	25.0%	13.3%	30.8%	30.8%
Yellow Time (s)	4.0	4.7	4.7	4.0	4.7	4.7	3.6	4.4	4.0	3.6	4.4	4.4
All-Red Time (s)	2.0	1.0	1.0	2.0	1.0	1.0	2.0	1.2	2.0	2.0	1.2	1.2
Lost Time Adjust (s)	0.0	0.0	0.0	0.0	0.0	0.0	0.0	0.0	0.0	0.0	0.0	0.0
Total Lost Time (s)	6.0	5.7	5.7	6.0	5.7	5.7	5.6	5.6	6.0	5.6	5.6	5.6
Lead/Lag	Lead	Lead	Lead	Lag	Lag	Lag	Lag	Lag	Lag	Lead	Lead	Lead
Lead-Lag Optimize?	Yes	Yes	Yes	Yes	Yes	Yes	Yes	Yes	Yes	Yes	Yes	Yes
Recall Mode	None	C-Min	C-Min	None	C-Min	C-Min	None	None	None	None	None	None
Act Effct Green (s)	16.2	41.6	41.6	24.5	49.9	49.9	5.7	20.6	44.7	10.4	31.8	31.8
Actuated g/C Ratio	0.14	0.35	0.35	0.20	0.42	0.42	0.05	0.17	0.37	0.09	0.26	0.26
v/c Ratio	0.79	0.81	0.10	0.99	0.52	0.25	0.17	0.74	0.69	0.88	0.73	0.51
Control Delay	78.3	40.9	2.8	79.7	28.7	5.5	41.5	35.6	18.4	83.2	45.7	9.1
Queue Delay	0.0	0.0	0.0	0.0	0.0	0.0	0.0	0.0	0.0	0.0	0.0	0.0
Total Delay	78.3	40.9	2.8	79.7	28.7	5.5	41.5	35.6	18.4	83.2	45.7	9.1
LOS	E	D	A	E	C	A	D	D	B	F	D	A
Approach Delay		46.8			44.5			27.1			44.1	
Approach LOS		D			D			C			D	

Intersection Summary

Cycle Length: 120
 Actuated Cycle Length: 120
 Offset: 93 (78%), Referenced to phase 4:WBT and 8:EBT, Start of 1st Green
 Natural Cycle: 90
 Control Type: Actuated-Coordinated
 Maximum v/c Ratio: 0.99
 Intersection Signal Delay: 42.4
 Intersection LOS: D
 Intersection Capacity Utilization 84.4%
 ICU Level of Service E
 Analysis Period (min) 15

Splits and Phases: 18: Greenway Hayden Loop & Frank Lloyd Wright Boulevard



18: Greenway Hayden Loop & Frank Lloyd Wright Boulevard

08/18/2022



Movement	EBL	EBT	EBR	WBL	WBT	WBR	NBL	NBT	NBR	SBL	SBT	SBR
Lane Configurations												
Traffic Volume (veh/h)	335	1320	62	638	1004	172	13	416	429	240	630	297
Future Volume (veh/h)	335	1320	62	638	1004	172	13	416	429	240	630	297
Initial Q (Qb), veh	0	0	0	0	0	0	0	0	0	0	0	0
Ped-Bike Adj(A_pbT)	1.00		1.00	1.00		1.00	1.00		1.00	1.00		1.00
Parking Bus, Adj	1.00	1.00	1.00	1.00	1.00	1.00	1.00	1.00	1.00	1.00	1.00	1.00
Work Zone On Approach		No			No			No			No	
Adj Sat Flow, veh/h/ln	1870	1870	1870	1870	1870	1870	1870	1870	1870	1870	1870	1870
Adj Flow Rate, veh/h	364	1435	67	693	1091	187	14	452	466	261	685	323
Peak Hour Factor	0.92	0.92	0.92	0.92	0.92	0.92	0.92	0.92	0.92	0.92	0.92	0.92
Percent Heavy Veh, %	2	2	2	2	2	2	2	2	2	2	2	2
Cap, veh/h	414	1459	453	992	2301	714	38	532	692	299	763	340
Arrive On Green	0.24	0.57	0.57	0.29	0.45	0.45	0.02	0.15	0.15	0.09	0.21	0.21
Sat Flow, veh/h	3456	5106	1585	3456	5106	1585	1781	3554	1585	3456	3554	1585
Grp Volume(v), veh/h	364	1435	67	693	1091	187	14	452	466	261	685	323
Grp Sat Flow(s),veh/h/ln	1728	1702	1585	1728	1702	1585	1781	1777	1585	1728	1777	1585
Q Serve(g_s), s	12.2	33.0	2.4	21.5	17.9	8.8	0.9	14.9	6.7	9.0	22.5	17.5
Cycle Q Clear(g_c), s	12.2	33.0	2.4	21.5	17.9	8.8	0.9	14.9	6.7	9.0	22.5	17.5
Prop In Lane	1.00		1.00	1.00		1.00	1.00		1.00	1.00		1.00
Lane Grp Cap(c), veh/h	414	1459	453	992	2301	714	38	532	692	299	763	340
V/C Ratio(X)	0.88	0.98	0.15	0.70	0.47	0.26	0.36	0.85	0.67	0.87	0.90	0.95
Avail Cap(c_a), veh/h	662	1459	453	992	2301	714	110	841	830	299	930	415
HCM Platoon Ratio	2.00	2.00	2.00	1.00	1.00	1.00	1.00	1.00	1.00	1.00	1.00	1.00
Upstream Filter(I)	0.82	0.82	0.82	1.00	1.00	1.00	1.00	1.00	1.00	1.00	1.00	1.00
Uniform Delay (d), s/veh	44.8	25.4	18.9	38.2	23.0	20.5	57.9	49.7	11.0	54.1	45.8	24.4
Incr Delay (d2), s/veh	4.2	17.7	0.6	1.8	0.7	0.9	2.1	2.7	1.0	22.4	8.9	26.9
Initial Q Delay(d3),s/veh	0.0	0.0	0.0	0.0	0.0	0.0	0.0	0.0	0.0	0.0	0.0	0.0
%ile BackOfQ(50%),veh/ln	4.7	10.2	0.9	9.0	7.0	3.3	0.4	6.7	5.2	4.8	10.6	8.8
Unsig. Movement Delay, s/veh												
LnGrp Delay(d),s/veh	49.0	43.1	19.4	40.0	23.7	21.4	60.0	52.5	12.0	76.6	54.8	51.3
LnGrp LOS	D	D	B	D	C	C	E	D	B	E	D	D
Approach Vol, veh/h		1866			1971			932			1269	
Approach Delay, s/veh		43.4			29.2			32.3			58.4	
Approach LOS		D			C			C			E	
Timer - Assigned Phs	1	2	3	4	5	6	7	8				
Phs Duration (G+Y+Rc), s	8.2	31.4	20.4	60.1	16.0	23.6	40.4	40.0				
Change Period (Y+Rc), s	* 5.6	5.6	6.0	* 6	5.6	* 5.6	6.0	5.7				
Max Green Setting (Gmax), s	* 7.4	31.4	23.0	* 35	10.4	* 28	24.0	34.3				
Max Q Clear Time (g_c+I1), s	2.9	24.5	14.2	19.9	11.0	16.9	23.5	35.0				
Green Ext Time (p_c), s	0.0	1.3	0.2	2.6	0.0	1.1	0.1	0.0				

Intersection Summary

HCM 6th Ctrl Delay	40.2
HCM 6th LOS	D

Notes

- User approved pedestrian interval to be less than phase max green.
- * HCM 6th computational engine requires equal clearance times for the phases crossing the barrier.

Intersection												
Int Delay, s/veh	6.8											
Movement	EBL	EBT	EBR	WBL	WBT	WBR	NBL	NBT	NBR	SBL	SBT	SBR
Lane Configurations		↕	↗		↕	↗	↖	↕↕	↖	↖	↕↕	↗
Traffic Vol, veh/h	76	7	16	13	5	27	17	756	35	57	1143	106
Future Vol, veh/h	76	7	16	13	5	27	17	756	35	57	1143	106
Conflicting Peds, #/hr	0	0	0	0	0	0	0	0	0	0	0	0
Sign Control	Stop	Stop	Stop	Stop	Stop	Stop	Free	Free	Free	Free	Free	Free
RT Channelized	-	-	None	-	-	None	-	-	None	-	-	None
Storage Length	-	-	130	-	-	130	150	-	-	110	-	175
Veh in Median Storage, #	-	0	-	-	0	-	-	0	-	-	0	-
Grade, %	-	0	-	-	0	-	-	0	-	-	0	-
Peak Hour Factor	92	92	92	92	92	92	92	92	92	92	92	92
Heavy Vehicles, %	2	2	2	2	2	2	2	2	2	2	2	2
Mvmt Flow	83	8	17	14	5	29	18	822	38	62	1242	115

Major/Minor	Minor2		Minor1		Major1		Major2					
Conflicting Flow All	1816	2262	621	1607	2339	411	1357	0	0	860	0	0
Stage 1	1366	1366	-	858	858	-	-	-	-	-	-	-
Stage 2	450	896	-	749	1481	-	-	-	-	-	-	-
Critical Hdwy	7.54	6.54	6.94	7.54	6.54	6.94	4.14	-	-	4.14	-	-
Critical Hdwy Stg 1	6.54	5.54	-	6.54	5.54	-	-	-	-	-	-	-
Critical Hdwy Stg 2	6.54	5.54	-	6.54	5.54	-	-	-	-	-	-	-
Follow-up Hdwy	3.52	4.02	3.32	3.52	4.02	3.32	2.22	-	-	2.22	-	-
Pot Cap-1 Maneuver	134	52	*607	*249	43	590	859	-	-	777	-	-
Stage 1	513	463	-	*318	372	-	-	-	-	-	-	-
Stage 2	558	357	-	*572	376	-	-	-	-	-	-	-
Platoon blocked, %	1	1	1	1	1	1	-	-	-	-	-	-
Mov Cap-1 Maneuver	105	47	*607	*196	39	590	859	-	-	777	-	-
Mov Cap-2 Maneuver	105	47	-	*196	39	-	-	-	-	-	-	-
Stage 1	502	426	-	*311	364	-	-	-	-	-	-	-
Stage 2	511	350	-	*502	346	-	-	-	-	-	-	-

Approach	EB		WB		NB		SB	
HCM Control Delay, s	135.3		28.3		0.2		0.4	
HCM LOS	F		D					

Minor Lane/Major Mvmt	NBL	NBT	NBR	EBLn1	EBLn2	WBLn1	WBLn2	SBL	SBT	SBR
Capacity (veh/h)	859	-	-	95	607	93	590	777	-	-
HCM Lane V/C Ratio	0.022	-	-	0.95	0.029	0.21	0.05	0.08	-	-
HCM Control Delay (s)	9.3	-	-	159.3	11.1	53.7	11.4	10	-	-
HCM Lane LOS	A	-	-	F	B	F	B	B	-	-
HCM 95th %tile Q(veh)	0.1	-	-	5.5	0.1	0.7	0.2	0.3	-	-

Notes
 ~: Volume exceeds capacity \$: Delay exceeds 300s +: Computation Not Defined *: All major volume in platoon

1: Scottsdale Road & Bell Road/Frank Lloyd Wright Boulevard

08/18/2022



Movement	EBL	EBT	EBR	WBL	WBT	WBR	NBL	NBT	NBR	SBL	SBT	SBR
Lane Configurations												
Traffic Volume (veh/h)	336	717	258	174	1109	590	388	1532	209	423	1249	328
Future Volume (veh/h)	336	717	258	174	1109	590	388	1532	209	423	1249	328
Initial Q (Qb), veh	0	0	0	0	0	0	0	0	0	0	0	0
Ped-Bike Adj(A_pbT)	1.00		1.00	1.00		1.00	1.00		1.00	1.00		1.00
Parking Bus, Adj	1.00	1.00	1.00	1.00	1.00	1.00	1.00	1.00	1.00	1.00	1.00	1.00
Work Zone On Approach		No			No			No			No	
Adj Sat Flow, veh/h/ln	1870	1870	1870	1870	1870	1870	1870	1870	1870	1870	1870	1870
Adj Flow Rate, veh/h	365	779	280	189	1205	641	422	1665	227	460	1358	357
Peak Hour Factor	0.92	0.92	0.92	0.92	0.92	0.92	0.92	0.92	0.92	0.92	0.92	0.92
Percent Heavy Veh, %	2	2	2	2	2	2	2	2	2	2	2	2
Cap, veh/h	317	1404	436	230	1285	736	461	1540	478	736	1529	401
Arrive On Green	0.09	0.27	0.27	0.02	0.08	0.08	0.04	0.10	0.10	0.21	0.38	0.38
Sat Flow, veh/h	3456	5106	1585	3456	5106	1585	3456	5106	1585	3456	4028	1056
Grp Volume(v), veh/h	365	779	280	189	1205	641	422	1665	227	460	1147	568
Grp Sat Flow(s),veh/h/ln	1728	1702	1585	1728	1702	1585	1728	1702	1585	1728	1702	1680
Q Serve(g_s), s	11.0	15.7	18.7	6.5	28.2	21.9	14.6	36.2	13.7	14.5	37.8	38.0
Cycle Q Clear(g_c), s	11.0	15.7	18.7	6.5	28.2	21.9	14.6	36.2	13.7	14.5	37.8	38.0
Prop In Lane	1.00		1.00	1.00		1.00	1.00		1.00	1.00		0.63
Lane Grp Cap(c), veh/h	317	1404	436	230	1285	736	461	1540	478	736	1292	638
V/C Ratio(X)	1.15	0.55	0.64	0.82	0.94	0.87	0.92	1.08	0.47	0.63	0.89	0.89
Avail Cap(c_a), veh/h	317	1413	439	230	1285	736	461	1540	478	736	1292	638
HCM Platoon Ratio	1.00	1.00	1.00	0.33	0.33	0.33	0.33	0.33	0.33	1.00	1.00	1.00
Upstream Filter(I)	1.00	1.00	1.00	0.86	0.86	0.86	0.70	0.70	0.70	1.00	1.00	1.00
Uniform Delay (d), s/veh	54.5	37.2	38.3	58.0	54.1	38.7	56.7	54.0	31.9	42.9	34.8	34.9
Incr Delay (d2), s/veh	98.4	0.3	2.4	17.0	11.4	9.3	17.3	45.2	2.4	1.3	9.3	17.1
Initial Q Delay(d3),s/veh	0.0	0.0	0.0	0.0	0.0	0.0	0.0	0.0	0.0	0.0	0.0	0.0
%ile BackOfQ(50%),veh/ln	9.0	6.4	7.3	3.4	14.2	10.7	7.9	22.9	6.1	6.1	16.5	17.7
Unsig. Movement Delay, s/veh												
LnGrp Delay(d),s/veh	152.9	37.5	40.8	74.9	65.5	48.0	74.0	99.2	34.3	44.1	44.1	52.0
LnGrp LOS	F	D	D	E	E	D	E	F	C	D	D	D
Approach Vol, veh/h		1424			2035			2314			2175	
Approach Delay, s/veh		67.7			60.9			88.3			46.2	
Approach LOS		E			E			F			D	
Timer - Assigned Phs	1	2	3	4	5	6	7	8				
Phs Duration (G+Y+Rc), s	22.0	51.7	17.0	36.0	31.7	42.0	14.0	39.0				
Change Period (Y+Rc), s	6.0	* 6	* 6	5.8	* 6	5.8	6.0	* 6				
Max Green Setting (Gmax), s	16.0	* 39	* 11	30.2	* 19	36.2	8.0	* 33				
Max Q Clear Time (g_c+I1), s	16.6	40.0	13.0	30.2	16.5	38.2	8.5	20.7				
Green Ext Time (p_c), s	0.0	0.0	0.0	0.0	0.3	0.0	0.0	1.7				

Intersection Summary

HCM 6th Ctrl Delay	66.1
HCM 6th LOS	E

Notes

- User approved pedestrian interval to be less than phase max green.
- * HCM 6th computational engine requires equal clearance times for the phases crossing the barrier.

2: Scottsdale Road & Paradise Lane

08/18/2022

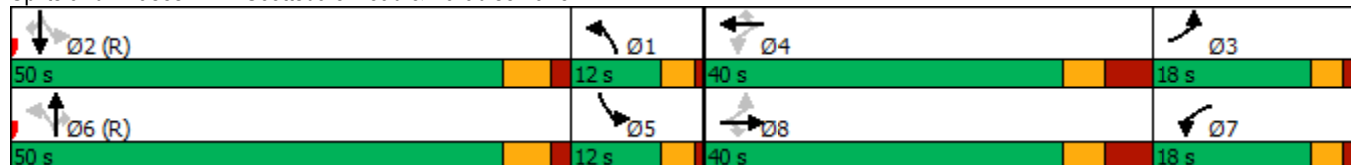


Lane Group	EBL	EBT	EBR	WBL	WBT	WBR	NBL	NBT	NBR	SBL	SBT	SBR
Lane Configurations												
Traffic Volume (vph)	112	29	20	181	32	272	13	1718	108	137	1448	28
Future Volume (vph)	112	29	20	181	32	272	13	1718	108	137	1448	28
Turn Type	pm+pt	NA	Perm	pm+pt	NA	Perm	pm+pt	NA	Perm	pm+pt	NA	Perm
Protected Phases	3	8		7	4		1	6		5	2	
Permitted Phases	8		8	4		4	6		6	2		2
Detector Phase	3	8	8	7	4	4	1	6	6	5	2	2
Switch Phase												
Minimum Initial (s)	4.0	7.0	7.0	4.0	7.0	7.0	4.0	10.0	10.0	4.0	10.0	10.0
Minimum Split (s)	10.0	15.0	15.0	11.0	15.0	15.0	11.0	16.0	16.0	11.0	16.0	16.0
Total Split (s)	18.0	40.0	40.0	18.0	40.0	40.0	12.0	50.0	50.0	12.0	50.0	50.0
Total Split (%)	15.0%	33.3%	33.3%	15.0%	33.3%	33.3%	10.0%	41.7%	41.7%	10.0%	41.7%	41.7%
Yellow Time (s)	3.0	3.7	3.7	3.0	3.7	3.7	3.0	4.3	4.3	3.0	4.3	4.3
All-Red Time (s)	1.0	4.3	4.3	1.0	4.3	4.3	1.0	1.7	1.7	1.0	1.7	1.7
Lost Time Adjust (s)	0.0	0.0	0.0	0.0	0.0	0.0	0.0	0.0	0.0	0.0	0.0	0.0
Total Lost Time (s)	4.0	8.0	8.0	4.0	8.0	8.0	4.0	6.0	6.0	4.0	6.0	6.0
Lead/Lag	Lag	Lead	Lead	Lag	Lead	Lead	Lag	Lead	Lead	Lag	Lead	Lead
Lead-Lag Optimize?	Yes	Yes	Yes	Yes	Yes	Yes	Yes	Yes	Yes	Yes	Yes	Yes
Recall Mode	None	None	None	None	None	None	None	C-Min	C-Min	None	C-Min	C-Min
Act Effct Green (s)	18.0	7.5	7.5	24.5	9.7	9.7	76.4	67.9	67.9	80.2	73.4	73.4
Actuated g/C Ratio	0.15	0.06	0.06	0.20	0.08	0.08	0.64	0.57	0.57	0.67	0.61	0.61
v/c Ratio	0.52	0.28	0.11	0.60	0.23	0.77	0.05	0.65	0.12	0.62	0.51	0.03
Control Delay	49.4	59.6	1.2	50.8	53.6	21.1	4.2	7.3	0.6	24.9	8.2	0.0
Queue Delay	0.0	0.0	0.0	0.0	0.0	0.0	0.0	0.0	0.0	0.0	0.0	0.0
Total Delay	49.4	59.6	1.2	50.8	53.6	21.1	4.2	7.3	0.6	24.9	8.2	0.0
LOS	D	E	A	D	D	C	A	A	A	C	A	A
Approach Delay		45.2			34.3			6.9			9.5	
Approach LOS		D			C			A			A	

Intersection Summary

Cycle Length: 120
 Actuated Cycle Length: 120
 Offset: 49 (41%), Referenced to phase 2:SBTL and 6:NBTL, Start of 1st Green
 Natural Cycle: 70
 Control Type: Actuated-Coordinated
 Maximum v/c Ratio: 0.77
 Intersection Signal Delay: 12.7
 Intersection Capacity Utilization 72.5%
 Analysis Period (min) 15
 Intersection LOS: B
 ICU Level of Service C

Splits and Phases: 2: Scottsdale Road & Paradise Lane



2: Scottsdale Road & Paradise Lane

08/18/2022



Movement	EBL	EBT	EBR	WBL	WBT	WBR	NBL	NBT	NBR	SBL	SBT	SBR
Lane Configurations	↖	↑	↗	↖	↑	↗	↖	↑↑↑	↗	↖	↑↑↑	↗
Traffic Volume (veh/h)	112	29	20	181	32	272	13	1718	108	137	1448	28
Future Volume (veh/h)	112	29	20	181	32	272	13	1718	108	137	1448	28
Initial Q (Qb), veh	0	0	0	0	0	0	0	0	0	0	0	0
Ped-Bike Adj(A_pbT)	1.00		1.00	1.00		1.00	1.00		1.00	1.00		1.00
Parking Bus, Adj	1.00	1.00	1.00	1.00	1.00	1.00	1.00	1.00	1.00	1.00	1.00	1.00
Work Zone On Approach		No			No			No			No	
Adj Sat Flow, veh/h/ln	1870	1870	1870	1870	1870	1870	1870	1870	1870	1870	1870	1870
Adj Flow Rate, veh/h	122	32	22	197	35	296	14	1867	117	149	1574	30
Peak Hour Factor	0.92	0.92	0.92	0.92	0.92	0.92	0.92	0.92	0.92	0.92	0.92	0.92
Percent Heavy Veh, %	2	2	2	2	2	2	2	2	2	2	2	2
Cap, veh/h	164	109	92	411	380	322	508	1872	581	441	1706	530
Arrive On Green	0.03	0.06	0.06	0.18	0.20	0.20	0.49	0.73	0.73	0.07	0.11	0.11
Sat Flow, veh/h	1781	1870	1585	1781	1870	1585	1781	5106	1585	1781	5106	1585
Grp Volume(v), veh/h	122	32	22	197	35	296	14	1867	117	149	1574	30
Grp Sat Flow(s),veh/h/ln	1781	1870	1585	1781	1870	1585	1781	1702	1585	1781	1702	1585
Q Serve(g_s), s	0.9	2.0	1.6	5.1	1.8	22.0	0.0	43.5	2.8	5.4	36.6	2.0
Cycle Q Clear(g_c), s	0.9	2.0	1.6	5.1	1.8	22.0	0.0	43.5	2.8	5.4	36.6	2.0
Prop In Lane	1.00		1.00	1.00		1.00	1.00		1.00	1.00		1.00
Lane Grp Cap(c), veh/h	164	109	92	411	380	322	508	1872	581	441	1706	530
V/C Ratio(X)	0.75	0.29	0.24	0.48	0.09	0.92	0.03	1.00	0.20	0.34	0.92	0.06
Avail Cap(c_a), veh/h	313	499	423	411	499	423	508	1872	581	441	1872	581
HCM Platoon Ratio	1.00	1.00	1.00	1.00	1.00	1.00	2.00	2.00	2.00	0.33	0.33	0.33
Upstream Filter(I)	1.00	1.00	1.00	1.00	1.00	1.00	1.00	1.00	1.00	0.22	0.22	0.22
Uniform Delay (d), s/veh	55.2	54.1	54.0	41.2	38.8	46.8	21.8	15.9	10.5	45.3	51.8	36.4
Incr Delay (d2), s/veh	2.5	0.5	0.5	0.3	0.0	18.8	0.0	20.2	0.8	0.0	2.6	0.0
Initial Q Delay(d3),s/veh	0.0	0.0	0.0	0.0	0.0	0.0	0.0	0.0	0.0	0.0	0.0	0.0
%ile BackOfQ(50%),veh/ln	3.7	1.0	0.7	5.0	0.8	10.4	0.2	8.9	1.1	4.2	17.0	0.8
Unsig. Movement Delay, s/veh												
LnGrp Delay(d),s/veh	57.8	54.7	54.4	41.5	38.9	65.6	21.9	36.1	11.3	45.3	54.4	36.5
LnGrp LOS	E	D	D	D	D	E	C	D	B	D	D	D
Approach Vol, veh/h		176			528			1998			1753	
Approach Delay, s/veh		56.8			54.9			34.5			53.3	
Approach LOS		E			D			C			D	
Timer - Assigned Phs	1	2	3	4	5	6	7	8				
Phs Duration (G+Y+Rc), s	33.6	46.1	7.9	32.4	29.7	50.0	25.3	15.0				
Change Period (Y+Rc), s	* 4	6.0	* 4	8.0	* 4	6.0	* 4	8.0				
Max Green Setting (Gmax), s	* 8	44.0	* 14	32.0	* 8	44.0	* 14	32.0				
Max Q Clear Time (g_c+I1), s	2.0	38.6	2.9	24.0	7.4	45.5	7.1	4.0				
Green Ext Time (p_c), s	0.0	1.5	0.1	0.4	0.0	0.0	0.1	0.1				

Intersection Summary

HCM 6th Ctrl Delay	45.2
HCM 6th LOS	D

Notes

- User approved pedestrian interval to be less than phase max green.
- * HCM 6th computational engine requires equal clearance times for the phases crossing the barrier.

3: Scottsdale Road & Driveway A

08/18/2022

Intersection												
Int Delay, s/veh	0.7											
Movement	EBL	EBT	EBR	WBL	WBT	WBR	NBL	NBT	NBR	SBL	SBT	SBR
Lane Configurations			↗			↗	↘	↑↑↑	↗	↘	↑↑↑	↗
Traffic Vol, veh/h	0	0	2	0	0	109	2	1724	128	92	1573	1
Future Vol, veh/h	0	0	2	0	0	109	2	1724	128	92	1573	1
Conflicting Peds, #/hr	0	0	0	0	0	0	0	0	0	0	0	0
Sign Control	Stop	Stop	Stop	Stop	Stop	Stop	Free	Free	Free	Free	Free	Free
RT Channelized	-	-	None	-	-	None	-	-	None	-	-	None
Storage Length	-	-	0	-	-	0	110	-	150	150	-	110
Veh in Median Storage, #	-	0	-	-	0	-	-	0	-	-	0	-
Grade, %	-	0	-	-	0	-	-	0	-	-	0	-
Peak Hour Factor	92	92	92	92	92	92	92	92	92	92	92	92
Heavy Vehicles, %	2	2	2	2	2	2	2	2	2	2	2	2
Mvmt Flow	0	0	2	0	0	118	2	1874	139	100	1710	1

Major/Minor	Minor2		Minor1		Major1			Major2				
Conflicting Flow All	-	-	855	-	-	937	1711	0	0	2013	0	0
Stage 1	-	-	-	-	-	-	-	-	-	-	-	-
Stage 2	-	-	-	-	-	-	-	-	-	-	-	-
Critical Hdwy	-	-	7.14	-	-	7.14	5.34	-	-	5.34	-	-
Critical Hdwy Stg 1	-	-	-	-	-	-	-	-	-	-	-	-
Critical Hdwy Stg 2	-	-	-	-	-	-	-	-	-	-	-	-
Follow-up Hdwy	-	-	3.92	-	-	3.92	3.12	-	-	3.12	-	-
Pot Cap-1 Maneuver	0	0	*567	0	0	*524	*713	-	-	565	-	-
Stage 1	0	0	-	0	0	-	-	-	-	-	-	-
Stage 2	0	0	-	0	0	-	-	-	-	-	-	-
Platoon blocked, %			1			1	1	-	-	1	-	-
Mov Cap-1 Maneuver	-	-	*567	-	-	*524	*713	-	-	565	-	-
Mov Cap-2 Maneuver	-	-	-	-	-	-	-	-	-	-	-	-
Stage 1	-	-	-	-	-	-	-	-	-	-	-	-
Stage 2	-	-	-	-	-	-	-	-	-	-	-	-

Approach	EB		WB		NB			SB		
HCM Control Delay, s	11.4		13.9		0			0.7		
HCM LOS	B		B							

Minor Lane/Major Mvmt	NBL	NBT	NBR	EBLn1	WBLn1	SBL	SBT	SBR
Capacity (veh/h)	* 713	-	-	567	524	565	-	-
HCM Lane V/C Ratio	0.003	-	-	0.004	0.226	0.177	-	-
HCM Control Delay (s)	10.1	-	-	11.4	13.9	12.7	-	-
HCM Lane LOS	B	-	-	B	B	B	-	-
HCM 95th %tile Q(veh)	0	-	-	0	0.9	0.6	-	-

Notes
 ~: Volume exceeds capacity \$: Delay exceeds 300s +: Computation Not Defined *: All major volume in platoon

4: Scottsdale Road & Tierra Buena Lane

08/18/2022



Movement	EBL	EBT	EBR	WBL	WBT	WBR	NBL	NBT	NBR	SBL	SBT	SBR
Lane Configurations	↖	↗		↖	↖	↖	↖	↑↑↑	↖	↖	↑↑↑	↖
Traffic Volume (veh/h)	11	2	35	102	1	186	34	1669	113	140	1471	13
Future Volume (veh/h)	11	2	35	102	1	186	34	1669	113	140	1471	13
Initial Q (Qb), veh	0	0	0	0	0	0	0	0	0	0	0	0
Ped-Bike Adj(A_pbT)	1.00		1.00	1.00		1.00	1.00		1.00	1.00		1.00
Parking Bus, Adj	1.00	1.00	1.00	1.00	1.00	1.00	1.00	1.00	1.00	1.00	1.00	1.00
Work Zone On Approach		No			No			No			No	
Adj Sat Flow, veh/h/ln	1870	1870	1870	1870	1870	1870	1870	1870	1870	1870	1870	1870
Adj Flow Rate, veh/h	12	2	38	111	1	202	37	1814	123	152	1599	14
Peak Hour Factor	0.92	0.92	0.92	0.92	0.92	0.92	0.92	0.92	0.92	0.92	0.92	0.92
Percent Heavy Veh, %	2	2	2	2	2	2	2	2	2	2	2	2
Cap, veh/h	148	5	88	256	269	228	664	1973	612	551	1662	516
Arrive On Green	0.01	0.06	0.06	0.10	0.14	0.14	0.34	0.39	0.39	0.55	0.65	0.65
Sat Flow, veh/h	1781	80	1517	1781	1870	1585	1781	5106	1585	1781	5106	1585
Grp Volume(v), veh/h	12	0	40	111	1	202	37	1814	123	152	1599	14
Grp Sat Flow(s),veh/h/ln	1781	0	1597	1781	1870	1585	1781	1702	1585	1781	1702	1585
Q Serve(g_s), s	0.0	0.0	2.9	1.2	0.1	15.0	0.0	40.6	6.2	0.7	35.1	0.4
Cycle Q Clear(g_c), s	0.0	0.0	2.9	1.2	0.1	15.0	0.0	40.6	6.2	0.7	35.1	0.4
Prop In Lane	1.00		0.95	1.00		1.00	1.00		1.00	1.00		1.00
Lane Grp Cap(c), veh/h	148	0	93	256	269	228	664	1973	612	551	1662	516
V/C Ratio(X)	0.08	0.00	0.43	0.43	0.00	0.89	0.06	0.92	0.20	0.28	0.96	0.03
Avail Cap(c_a), veh/h	247	0	386	256	452	383	664	2042	634	551	2042	634
HCM Platoon Ratio	1.00	1.00	1.00	1.00	1.00	1.00	1.00	1.00	1.00	2.00	2.00	2.00
Upstream Filter(I)	1.00	0.00	1.00	1.00	1.00	1.00	0.69	0.69	0.69	1.00	1.00	1.00
Uniform Delay (d), s/veh	52.6	0.0	54.6	48.8	44.0	50.4	26.3	35.0	24.5	19.5	20.3	14.2
Incr Delay (d2), s/veh	0.1	0.0	1.2	0.4	0.0	7.0	0.0	6.1	0.5	0.1	14.8	0.1
Initial Q Delay(d3),s/veh	0.0	0.0	0.0	0.0	0.0	0.0	0.0	0.0	0.0	0.0	0.0	0.0
%ile BackOfQ(50%),veh/ln	0.3	0.0	1.2	3.1	0.0	6.4	0.7	17.0	2.4	2.0	8.7	0.2
Unsig. Movement Delay, s/veh												
LnGrp Delay(d),s/veh	52.6	0.0	55.7	49.3	44.0	57.4	26.3	41.2	25.0	19.6	35.0	14.3
LnGrp LOS	D	A	E	D	D	E	C	D	C	B	D	B
Approach Vol, veh/h		52			314			1974			1765	
Approach Delay, s/veh		55.0			54.5			39.9			33.5	
Approach LOS		E			D			D			C	
Timer - Assigned Phs	1	2	3	4	5	6	7	8				
Phs Duration (G+Y+Rc), s	44.4	45.1	5.3	25.3	37.0	52.4	15.6	15.0				
Change Period (Y+Rc), s	* 4	6.0	* 4	8.0	* 4	6.0	* 4	8.0				
Max Green Setting (Gmax), s	* 13	48.0	* 8	29.0	* 13	48.0	* 8	29.0				
Max Q Clear Time (g_c+I1), s	2.0	37.1	2.0	17.0	2.7	42.6	3.2	4.9				
Green Ext Time (p_c), s	0.0	2.0	0.0	0.3	0.1	3.8	0.1	0.1				

Intersection Summary

HCM 6th Ctrl Delay	38.5
HCM 6th LOS	D

Notes

- User approved pedestrian interval to be less than phase max green.
- * HCM 6th computational engine requires equal clearance times for the phases crossing the barrier.

5: Scottsdale Road & Kierland Boulevard/Greenway Hayden Loop

08/18/2022



Movement	EBL	EBT	EBR	WBL	WBT	WBR	NBL	NBT	NBR	SBL	SBT	SBR
Lane Configurations												
Traffic Volume (veh/h)	205	206	84	438	403	151	128	1421	305	232	1096	264
Future Volume (veh/h)	205	206	84	438	403	151	128	1421	305	232	1096	264
Initial Q (Qb), veh	0	0	0	0	0	0	0	0	0	0	0	0
Ped-Bike Adj(A_pbT)	1.00		1.00	1.00		1.00	1.00		1.00	1.00		1.00
Parking Bus, Adj	1.00	1.00	1.00	1.00	1.00	1.00	1.00	1.00	1.00	1.00	1.00	1.00
Work Zone On Approach		No			No			No			No	
Adj Sat Flow, veh/h/ln	1870	1870	1870	1870	1870	1870	1870	1870	1870	1870	1870	1870
Adj Flow Rate, veh/h	223	224	91	476	438	164	139	1545	332	252	1191	287
Peak Hour Factor	0.92	0.92	0.92	0.92	0.92	0.92	0.92	0.92	0.92	0.92	0.92	0.92
Percent Heavy Veh, %	2	2	2	2	2	2	2	2	2	2	2	2
Cap, veh/h	304	305	136	538	566	203	960	1682	522	823	1480	459
Arrive On Green	0.09	0.09	0.09	0.05	0.05	0.05	0.56	0.66	0.66	0.08	0.10	0.10
Sat Flow, veh/h	3456	3554	1585	3456	3704	1331	3456	5106	1585	3456	5106	1585
Grp Volume(v), veh/h	223	224	91	476	401	201	139	1545	332	252	1191	287
Grp Sat Flow(s),veh/h/ln	1728	1777	1585	1728	1702	1631	1728	1702	1585	1728	1702	1585
Q Serve(g_s), s	7.5	7.4	3.9	16.4	14.0	14.6	2.3	31.4	9.3	8.3	27.4	20.9
Cycle Q Clear(g_c), s	7.5	7.4	3.9	16.4	14.0	14.6	2.3	31.4	9.3	8.3	27.4	20.9
Prop In Lane	1.00		1.00	1.00		0.82	1.00		1.00	1.00		1.00
Lane Grp Cap(c), veh/h	304	305	136	538	520	249	960	1682	522	823	1480	459
V/C Ratio(X)	0.73	0.73	0.67	0.89	0.77	0.81	0.14	0.92	0.64	0.31	0.80	0.62
Avail Cap(c_a), veh/h	625	782	349	587	718	344	960	1928	598	823	1928	598
HCM Platoon Ratio	1.00	1.00	1.00	0.33	0.33	0.33	2.00	2.00	2.00	0.33	0.33	0.33
Upstream Filter(I)	1.00	1.00	1.00	0.92	0.92	0.92	0.70	0.70	0.70	0.85	0.85	0.85
Uniform Delay (d), s/veh	53.4	53.5	18.5	55.9	54.9	55.2	19.8	19.1	6.4	45.9	50.9	48.0
Incr Delay (d2), s/veh	1.3	1.3	2.1	12.5	2.0	6.1	0.0	7.1	4.1	0.1	4.1	5.4
Initial Q Delay(d3),s/veh	0.0	0.0	0.0	0.0	0.0	0.0	0.0	0.0	0.0	0.0	0.0	0.0
%ile BackOfQ(50%),veh/ln	3.3	3.3	2.6	8.5	6.5	6.8	0.9	6.9	4.1	3.7	13.0	9.6
Unsig. Movement Delay, s/veh												
LnGrp Delay(d),s/veh	54.6	54.8	20.6	68.3	56.9	61.4	19.8	26.2	10.5	46.0	55.0	53.4
LnGrp LOS	D	D	C	E	E	E	B	C	B	D	D	D
Approach Vol, veh/h		538			1078			2016			1730	
Approach Delay, s/veh		49.0			62.8			23.1			53.4	
Approach LOS		D			E			C			D	
Timer - Assigned Phs	1	2	3	4	5	6	7	8				
Phs Duration (G+Y+Rc), s	39.3	40.5	16.2	24.0	34.6	45.2	24.3	15.9				
Change Period (Y+Rc), s	6.0	5.7	* 5.6	* 5.7	6.0	5.7	5.6	* 5.6				
Max Green Setting (Gmax), s	5.0	45.3	* 22	* 25	5.0	45.3	20.4	* 26				
Max Q Clear Time (g_c+I1), s	4.3	29.4	9.5	16.6	10.3	33.4	18.4	9.4				
Green Ext Time (p_c), s	0.0	5.4	0.3	1.7	0.0	6.2	0.2	0.9				

Intersection Summary

HCM 6th Ctrl Delay	43.5
HCM 6th LOS	D

Notes

User approved pedestrian interval to be less than phase max green.
 * HCM 6th computational engine requires equal clearance times for the phases crossing the barrier.

6: Scottsdale Road & Greenway Parkway/Butherus Drive

08/18/2022

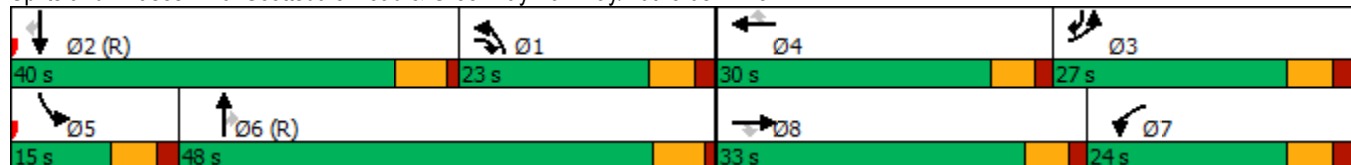


Lane Group	EBL	EBT	EBR	WBL	WBT	WBR	NBL	NBT	NBR	SBL	SBT	SBR
Lane Configurations	↔↔	↕↔	↔	↔↔	↕↕	↔	↔↔	↕↕↕	↔	↔↔	↕↕↕	↔
Traffic Volume (vph)	288	222	204	333	444	238	461	1353	262	111	1256	225
Future Volume (vph)	288	222	204	333	444	238	461	1353	262	111	1256	225
Turn Type	Prot	NA	pm+ov	Prot	NA	Perm	Prot	NA	Perm	Prot	NA	pm+ov
Protected Phases	3	8	1	7	4		1	6		5	2	3
Permitted Phases			8			4			6			2
Detector Phase	3	8	1	7	4	4	1	6	6	5	2	3
Switch Phase												
Minimum Initial (s)	5.0	7.0	5.0	5.0	7.0	7.0	5.0	10.0	10.0	5.0	10.0	5.0
Minimum Split (s)	11.0	13.2	11.0	11.0	13.2	13.2	11.0	16.0	16.0	11.0	16.0	11.0
Total Split (s)	27.0	33.0	23.0	24.0	30.0	30.0	23.0	48.0	48.0	15.0	40.0	27.0
Total Split (%)	22.5%	27.5%	19.2%	20.0%	25.0%	25.0%	19.2%	40.0%	40.0%	12.5%	33.3%	22.5%
Yellow Time (s)	4.0	4.0	4.0	4.0	4.0	4.0	4.0	4.7	4.7	4.0	4.7	4.0
All-Red Time (s)	2.0	1.5	2.0	2.0	1.5	1.5	2.0	1.0	1.0	2.0	1.0	2.0
Lost Time Adjust (s)	0.0	0.0	0.0	0.0	0.0	0.0	0.0	0.0	0.0	0.0	0.0	0.0
Total Lost Time (s)	6.0	5.5	6.0	6.0	5.5	5.5	6.0	5.7	5.7	6.0	5.7	6.0
Lead/Lag	Lag	Lead	Lag	Lag	Lead	Lead	Lag	Lag	Lag	Lead	Lead	Lag
Lead-Lag Optimize?	Yes	Yes	Yes	Yes	Yes	Yes	Yes	Yes	Yes	Yes	Yes	Yes
Recall Mode	None	None	None	None	None	None	None	C-Min	C-Min	None	C-Min	None
Act Effct Green (s)	15.3	15.1	39.1	20.9	20.7	20.7	18.5	52.4	52.4	8.5	42.3	63.3
Actuated g/C Ratio	0.13	0.13	0.33	0.17	0.17	0.17	0.15	0.44	0.44	0.07	0.35	0.53
v/c Ratio	0.72	0.73	0.25	0.61	0.79	0.61	0.95	0.66	0.37	0.50	0.76	0.28
Control Delay	59.6	55.2	6.6	49.9	57.3	19.4	78.8	30.1	15.0	79.4	17.1	3.8
Queue Delay	0.0	0.0	0.0	0.0	0.0	0.0	0.0	0.0	0.0	0.0	0.0	0.0
Total Delay	59.6	55.2	6.6	49.9	57.3	19.4	78.8	30.1	15.0	79.4	17.1	3.8
LOS	E	E	A	D	E	B	E	C	B	E	B	A
Approach Delay		48.1			46.0			39.0			19.6	
Approach LOS		D			D			D			B	

Intersection Summary

Cycle Length: 120
 Actuated Cycle Length: 120
 Offset: 97 (81%), Referenced to phase 2:SBT and 6:NBT, Start of 1st Green
 Natural Cycle: 90
 Control Type: Actuated-Coordinated
 Maximum v/c Ratio: 0.95
 Intersection Signal Delay: 35.8
 Intersection LOS: D
 Intersection Capacity Utilization 76.9%
 ICU Level of Service D
 Analysis Period (min) 15

Splits and Phases: 6: Scottsdale Road & Greenway Parkway/Butherus Drive



6: Scottsdale Road & Greenway Parkway/Butherus Drive

08/18/2022



Movement	EBL	EBT	EBR	WBL	WBT	WBR	NBL	NBT	NBR	SBL	SBT	SBR
Lane Configurations	↔↔	↕↔	↔	↔↔	↕↕	↔	↔↔	↕↕↕	↔	↔↔	↕↕↕	↔
Traffic Volume (veh/h)	288	222	204	333	444	238	461	1353	262	111	1256	225
Future Volume (veh/h)	288	222	204	333	444	238	461	1353	262	111	1256	225
Initial Q (Qb), veh	0	0	0	0	0	0	0	0	0	0	0	0
Ped-Bike Adj(A_pbT)	1.00		1.00	1.00		1.00	1.00		1.00	1.00		1.00
Parking Bus, Adj	1.00	1.00	1.00	1.00	1.00	1.00	1.00	1.00	1.00	1.00	1.00	1.00
Work Zone On Approach		No			No			No			No	
Adj Sat Flow, veh/h/ln	1870	1870	1870	1870	1870	1870	1870	1870	1870	1870	1870	1870
Adj Flow Rate, veh/h	313	343	154	362	483	259	501	1471	0	121	1365	245
Peak Hour Factor	0.92	0.92	0.92	0.92	0.92	0.92	0.92	0.92	0.92	0.92	0.92	0.92
Percent Heavy Veh, %	2	2	2	2	2	2	2	2	2	2	2	2
Cap, veh/h	378	438	592	529	583	260	886	2472		173	1431	612
Arrive On Green	0.11	0.12	0.12	0.15	0.16	0.16	0.26	0.48	0.00	0.10	0.56	0.56
Sat Flow, veh/h	3563	3741	1585	3456	3554	1585	3456	5106	1585	3456	5106	1585
Grp Volume(v), veh/h	313	343	154	362	483	259	501	1471	0	121	1365	245
Grp Sat Flow(s),veh/h/ln	1781	1870	1585	1728	1777	1585	1728	1702	1585	1728	1702	1585
Q Serve(g_s), s	10.3	10.7	0.0	11.9	15.8	16.2	15.1	25.1	0.0	4.1	30.3	0.0
Cycle Q Clear(g_c), s	10.3	10.7	0.0	11.9	15.8	16.2	15.1	25.1	0.0	4.1	30.3	0.0
Prop In Lane	1.00		1.00	1.00		1.00	1.00		1.00	1.00		1.00
Lane Grp Cap(c), veh/h	378	438	592	529	583	260	886	2472		173	1431	612
V/C Ratio(X)	0.83	0.78	0.26	0.68	0.83	1.00	0.57	0.60		0.70	0.95	0.40
Avail Cap(c_a), veh/h	623	857	770	529	726	324	886	2472		259	1459	621
HCM Platoon Ratio	1.00	1.00	1.00	1.00	1.00	1.00	1.00	1.00	1.00	2.00	2.00	2.00
Upstream Filter(I)	1.00	1.00	1.00	1.00	1.00	1.00	1.00	1.00	0.00	0.70	0.70	0.70
Uniform Delay (d), s/veh	52.6	51.5	26.1	48.1	48.5	34.2	38.8	22.4	0.0	53.1	25.6	15.2
Incr Delay (d2), s/veh	1.9	1.2	0.1	3.0	5.4	43.4	0.5	1.1	0.0	1.4	11.6	1.4
Initial Q Delay(d3),s/veh	0.0	0.0	0.0	0.0	0.0	0.0	0.0	0.0	0.0	0.0	0.0	0.0
%ile BackOfQ(50%),veh/ln	4.6	5.0	3.0	5.3	7.4	9.2	6.3	9.7	0.0	1.7	8.9	3.0
Unsig. Movement Delay, s/veh												
LnGrp Delay(d),s/veh	54.5	52.7	26.2	51.1	53.9	77.6	39.3	23.5	0.0	54.5	37.3	16.6
LnGrp LOS	D	D	C	D	D	E	D	C		D	D	B
Approach Vol, veh/h		810			1104			1972			1731	
Approach Delay, s/veh		48.3			58.5			27.5			35.5	
Approach LOS		D			E			C			D	
Timer - Assigned Phs	1	2	3	4	5	6	7	8				
Phs Duration (G+Y+Rc), s	36.8	39.3	18.7	25.2	12.0	64.1	24.4	19.5				
Change Period (Y+Rc), s	6.0	5.7	6.0	5.5	6.0	* 6	6.0	5.5				
Max Green Setting (Gmax), s	17.0	34.3	21.0	24.5	9.0	* 42	18.0	27.5				
Max Q Clear Time (g_c+I1), s	17.1	32.3	12.3	18.2	6.1	27.1	13.9	12.7				
Green Ext Time (p_c), s	0.0	1.3	0.4	1.5	0.0	6.1	0.3	1.3				

Intersection Summary

HCM 6th Ctrl Delay	39.1
HCM 6th LOS	D

Notes

- User approved pedestrian interval to be less than phase max green.
- User approved volume balancing among the lanes for turning movement.
- * HCM 6th computational engine requires equal clearance times for the phases crossing the barrier.

Intersection						
Int Delay, s/veh	0.4					
Movement	EBT	EBR	WBL	WBT	NBL	NBR
Lane Configurations	↔			↑		↗
Traffic Vol, veh/h	244	57	0	562	0	38
Future Vol, veh/h	244	57	0	562	0	38
Conflicting Peds, #/hr	0	0	0	0	0	0
Sign Control	Free	Free	Free	Free	Stop	Stop
RT Channelized	-	None	-	None	-	None
Storage Length	-	-	-	-	-	0
Veh in Median Storage, #	0	-	-	0	0	-
Grade, %	0	-	-	0	0	-
Peak Hour Factor	92	92	92	92	92	92
Heavy Vehicles, %	2	2	2	2	2	2
Mvmt Flow	265	62	0	611	0	41
Major/Minor	Major1	Major2	Minor1			
Conflicting Flow All	0	0	-	-	-	296
Stage 1	-	-	-	-	-	-
Stage 2	-	-	-	-	-	-
Critical Hdwy	-	-	-	-	-	6.22
Critical Hdwy Stg 1	-	-	-	-	-	-
Critical Hdwy Stg 2	-	-	-	-	-	-
Follow-up Hdwy	-	-	-	-	-	3.318
Pot Cap-1 Maneuver	-	-	0	-	0	743
Stage 1	-	-	0	-	0	-
Stage 2	-	-	0	-	0	-
Platoon blocked, %	-	-	-	-	-	-
Mov Cap-1 Maneuver	-	-	-	-	-	743
Mov Cap-2 Maneuver	-	-	-	-	-	-
Stage 1	-	-	-	-	-	-
Stage 2	-	-	-	-	-	-
Approach	EB	WB	NB			
HCM Control Delay, s	0	0	10.1			
HCM LOS				B		
Minor Lane/Major Mvmt	NBLn1	EBT	EBR	WBT		
Capacity (veh/h)	743	-	-	-		
HCM Lane V/C Ratio	0.056	-	-	-		
HCM Control Delay (s)	10.1	-	-	-		
HCM Lane LOS	B	-	-	-		
HCM 95th %tile Q(veh)	0.2	-	-	-		

8: Driveway C & Paradise Lane

08/18/2022

Intersection												
Int Delay, s/veh	5.5											
Movement	EBL	EBT	EBR	WBL	WBT	WBR	NBL	NBT	NBR	SBL	SBT	SBR
Lane Configurations	↶	↷		↶	↷			↕			↕	
Traffic Vol, veh/h	59	167	21	9	284	56	54	0	10	41	0	144
Future Vol, veh/h	59	167	21	9	284	56	54	0	10	41	0	144
Conflicting Peds, #/hr	0	0	0	0	0	0	0	0	0	0	0	0
Sign Control	Free	Free	Free	Free	Free	Free	Stop	Stop	Stop	Stop	Stop	Stop
RT Channelized	-	-	None	-	-	None	-	-	None	-	-	None
Storage Length	100	-	-	100	-	-	-	-	-	-	-	-
Veh in Median Storage, #	-	0	-	-	0	-	-	0	-	-	0	-
Grade, %	-	0	-	-	0	-	-	0	-	-	0	-
Peak Hour Factor	92	92	92	92	92	92	92	92	92	92	92	92
Heavy Vehicles, %	2	2	2	2	2	2	2	2	2	2	2	2
Mvmt Flow	64	182	23	10	309	61	59	0	11	45	0	157

Major/Minor	Major1			Major2			Minor1			Minor2		
Conflicting Flow All	370	0	0	205	0	0	760	712	194	687	693	340
Stage 1	-	-	-	-	-	-	322	322	-	360	360	-
Stage 2	-	-	-	-	-	-	438	390	-	327	333	-
Critical Hdwy	4.12	-	-	4.12	-	-	7.12	6.52	6.22	7.12	6.52	6.22
Critical Hdwy Stg 1	-	-	-	-	-	-	6.12	5.52	-	6.12	5.52	-
Critical Hdwy Stg 2	-	-	-	-	-	-	6.12	5.52	-	6.12	5.52	-
Follow-up Hdwy	2.218	-	-	2.218	-	-	3.518	4.018	3.318	3.518	4.018	3.318
Pot Cap-1 Maneuver	1189	-	-	1397	-	-	332	363	940	377	374	702
Stage 1	-	-	-	-	-	-	743	673	-	658	626	-
Stage 2	-	-	-	-	-	-	597	608	-	737	666	-
Platoon blocked, %		-	-	1	-	-	1	1	1	1	1	
Mov Cap-1 Maneuver	1189	-	-	1397	-	-	246	341	940	356	351	702
Mov Cap-2 Maneuver	-	-	-	-	-	-	246	341	-	356	351	-
Stage 1	-	-	-	-	-	-	702	637	-	622	622	-
Stage 2	-	-	-	-	-	-	461	604	-	690	630	-

Approach	EB			WB			NB			SB		
HCM Control Delay, s	2			0.2			22.2			14.5		
HCM LOS							C			B		

Minor Lane/Major Mvmt	NBLn1	EBL	EBT	EBR	WBL	WBT	WBR	SBLn1
Capacity (veh/h)	278	1189	-	-	1397	-	-	578
HCM Lane V/C Ratio	0.25	0.054	-	-	0.007	-	-	0.348
HCM Control Delay (s)	22.2	8.2	-	-	7.6	-	-	14.5
HCM Lane LOS	C	A	-	-	A	-	-	B
HCM 95th %tile Q(veh)	1	0.2	-	-	0	-	-	1.6

Intersection						
Int Delay, s/veh	4.7					
Movement	EBT	EBR	WBL	WBT	NBL	NBR
Lane Configurations						
Traffic Vol, veh/h	141	118	103	234	116	146
Future Vol, veh/h	141	118	103	234	116	146
Conflicting Peds, #/hr	0	0	0	0	0	0
Sign Control	Free	Free	Free	Free	Stop	Stop
RT Channelized	-	None	-	None	-	None
Storage Length	-	-	100	-	80	0
Veh in Median Storage, #	0	-	-	0	0	-
Grade, %	0	-	-	0	0	-
Peak Hour Factor	92	92	92	92	92	92
Heavy Vehicles, %	2	2	2	2	2	2
Mvmt Flow	153	128	112	254	126	159
Major/Minor	Major1	Major2	Minor1			
Conflicting Flow All	0	0	281	0	695	217
Stage 1	-	-	-	-	217	-
Stage 2	-	-	-	-	478	-
Critical Hdwy	-	-	4.12	-	6.42	6.22
Critical Hdwy Stg 1	-	-	-	-	5.42	-
Critical Hdwy Stg 2	-	-	-	-	5.42	-
Follow-up Hdwy	-	-	2.218	-	3.518	3.318
Pot Cap-1 Maneuver	-	-	1293	-	415	889
Stage 1	-	-	-	-	853	-
Stage 2	-	-	-	-	624	-
Platoon blocked, %	-	-	1	-	1	1
Mov Cap-1 Maneuver	-	-	1293	-	379	889
Mov Cap-2 Maneuver	-	-	-	-	470	-
Stage 1	-	-	-	-	853	-
Stage 2	-	-	-	-	570	-
Approach	EB		WB		NB	
HCM Control Delay, s	0		2.5		12.3	
HCM LOS					B	
Minor Lane/Major Mvmt	NBLn1	NBLn2	EBT	EBR	WBL	WBT
Capacity (veh/h)	470	889	-	-	1293	-
HCM Lane V/C Ratio	0.268	0.179	-	-	0.087	-
HCM Control Delay (s)	15.4	9.9	-	-	8	-
HCM Lane LOS	C	A	-	-	A	-
HCM 95th %tile Q(veh)	1.1	0.6	-	-	0.3	-

Intersection						
Int Delay, s/veh	2.5					
Movement	EBL	EBR	NBL	NBT	SBT	SBR
Lane Configurations						
Traffic Vol, veh/h	71	28	41	219	200	47
Future Vol, veh/h	71	28	41	219	200	47
Conflicting Peds, #/hr	0	0	0	0	0	0
Sign Control	Stop	Stop	Free	Free	Free	Free
RT Channelized	-	None	-	None	-	None
Storage Length	0	-	100	-	-	-
Veh in Median Storage, #	0	-	-	0	0	-
Grade, %	0	-	-	0	0	-
Peak Hour Factor	92	92	92	92	92	92
Heavy Vehicles, %	2	2	2	2	2	2
Mvmt Flow	77	30	45	238	217	51

Major/Minor	Minor2	Major1	Major2			
Conflicting Flow All	571	243	268	0	-	0
Stage 1	243	-	-	-	-	-
Stage 2	328	-	-	-	-	-
Critical Hdwy	6.42	6.22	4.12	-	-	-
Critical Hdwy Stg 1	5.42	-	-	-	-	-
Critical Hdwy Stg 2	5.42	-	-	-	-	-
Follow-up Hdwy	3.518	3.318	2.218	-	-	-
Pot Cap-1 Maneuver	482	796	1296	-	-	-
Stage 1	797	-	-	-	-	-
Stage 2	730	-	-	-	-	-
Platoon blocked, %				-	-	-
Mov Cap-1 Maneuver	465	796	1296	-	-	-
Mov Cap-2 Maneuver	554	-	-	-	-	-
Stage 1	769	-	-	-	-	-
Stage 2	730	-	-	-	-	-

Approach	EB	NB	SB
HCM Control Delay, s	12.2	1.2	0
HCM LOS	B		

Minor Lane/Major Mvmt	NBL	NBT	EBLn1	SBT	SBR
Capacity (veh/h)	1296	-	606	-	-
HCM Lane V/C Ratio	0.034	-	0.178	-	-
HCM Control Delay (s)	7.9	-	12.2	-	-
HCM Lane LOS	A	-	B	-	-
HCM 95th %tile Q(veh)	0.1	-	0.6	-	-

Intersection						
Int Delay, s/veh	1.2					
Movement	WBL	WBR	NBT	NBR	SBL	SBT
Lane Configurations						
Traffic Vol, veh/h	26	26	200	7	1	169
Future Vol, veh/h	26	26	200	7	1	169
Conflicting Peds, #/hr	0	0	0	0	0	0
Sign Control	Stop	Stop	Free	Free	Free	Free
RT Channelized	-	None	-	None	-	None
Storage Length	75	0	-	-	100	-
Veh in Median Storage, #	0	-	0	-	-	0
Grade, %	0	-	0	-	-	0
Peak Hour Factor	92	92	92	92	92	92
Heavy Vehicles, %	2	2	2	2	2	2
Mvmt Flow	28	28	217	8	1	184

Major/Minor	Minor1	Major1	Major2		
Conflicting Flow All	407	221	0	0	225
Stage 1	221	-	-	-	-
Stage 2	186	-	-	-	-
Critical Hdwy	6.42	6.22	-	-	4.12
Critical Hdwy Stg 1	5.42	-	-	-	-
Critical Hdwy Stg 2	5.42	-	-	-	-
Follow-up Hdwy	3.518	3.318	-	-	2.218
Pot Cap-1 Maneuver	600	819	-	-	1344
Stage 1	816	-	-	-	-
Stage 2	846	-	-	-	-
Platoon blocked, %			-	-	-
Mov Cap-1 Maneuver	599	819	-	-	1344
Mov Cap-2 Maneuver	652	-	-	-	-
Stage 1	816	-	-	-	-
Stage 2	845	-	-	-	-

Approach	WB	NB	SB
HCM Control Delay, s	10.2	0	0
HCM LOS	B		

Minor Lane/Major Mvmt	NBT	NBRWBLn1	WBLn2	SBL	SBT
Capacity (veh/h)	-	-	652	819	1344
HCM Lane V/C Ratio	-	-	0.043	0.035	0.001
HCM Control Delay (s)	-	-	10.8	9.6	7.7
HCM Lane LOS	-	-	B	A	A
HCM 95th %tile Q(veh)	-	-	0.1	0.1	0

Intersection												
Int Delay, s/veh	2.5											
Movement	EBL	EBT	EBR	WBL	WBT	WBR	NBL	NBT	NBR	SBL	SBT	SBR
Lane Configurations		↕			↕		↕	↕		↕	↕	
Traffic Vol, veh/h	42	0	6	0	0	2	64	159	2	2	156	34
Future Vol, veh/h	42	0	6	0	0	2	64	159	2	2	156	34
Conflicting Peds, #/hr	0	0	0	0	0	0	0	0	0	0	0	0
Sign Control	Stop	Stop	Stop	Stop	Stop	Stop	Free	Free	Free	Free	Free	Free
RT Channelized	-	-	None	-	-	None	-	-	None	-	-	None
Storage Length	-	-	-	-	-	-	100	-	-	100	-	-
Veh in Median Storage, #	-	0	-	-	0	-	-	0	-	-	0	-
Grade, %	-	0	-	-	0	-	-	0	-	-	0	-
Peak Hour Factor	92	92	92	92	92	92	92	92	92	92	92	92
Heavy Vehicles, %	2	2	2	2	2	2	2	2	2	2	2	2
Mvmt Flow	46	0	7	0	0	2	70	173	2	2	170	37

Major/Minor	Minor2		Minor1		Major1		Major2					
Conflicting Flow All	508	508	189	510	525	174	207	0	0	175	0	0
Stage 1	193	193	-	314	314	-	-	-	-	-	-	-
Stage 2	315	315	-	196	211	-	-	-	-	-	-	-
Critical Hdwy	7.12	6.52	6.22	7.12	6.52	6.22	4.12	-	-	4.12	-	-
Critical Hdwy Stg 1	6.12	5.52	-	6.12	5.52	-	-	-	-	-	-	-
Critical Hdwy Stg 2	6.12	5.52	-	6.12	5.52	-	-	-	-	-	-	-
Follow-up Hdwy	3.518	4.018	3.318	3.518	4.018	3.318	2.218	-	-	2.218	-	-
Pot Cap-1 Maneuver	475	468	853	474	458	869	1364	-	-	1401	-	-
Stage 1	809	741	-	697	656	-	-	-	-	-	-	-
Stage 2	696	656	-	806	728	-	-	-	-	-	-	-
Platoon blocked, %								-	-	-	-	-
Mov Cap-1 Maneuver	455	444	853	451	434	869	1364	-	-	1401	-	-
Mov Cap-2 Maneuver	455	444	-	451	434	-	-	-	-	-	-	-
Stage 1	768	740	-	661	623	-	-	-	-	-	-	-
Stage 2	659	623	-	799	727	-	-	-	-	-	-	-

Approach	EB		WB		NB		SB			
HCM Control Delay, s	13.4		9.2		2.2		0.1			
HCM LOS	B		A							

Minor Lane/Major Mvmt	NBL	NBT	NBR	EBLn1WBLn1	SBL	SBT	SBR
Capacity (veh/h)	1364	-	-	483	869	1401	-
HCM Lane V/C Ratio	0.051	-	-	0.108	0.003	0.002	-
HCM Control Delay (s)	7.8	-	-	13.4	9.2	7.6	-
HCM Lane LOS	A	-	-	B	A	A	-
HCM 95th %tile Q(veh)	0.2	-	-	0.4	0	0	-

Intersection												
Int Delay, s/veh	3.9											
Movement	EBL	EBT	EBR	WBL	WBT	WBR	NBL	NBT	NBR	SBL	SBT	SBR
Lane Configurations	↖	↗		↖	↗			↕			↕	
Traffic Vol, veh/h	51	204	12	18	177	6	9	0	18	24	0	120
Future Vol, veh/h	51	204	12	18	177	6	9	0	18	24	0	120
Conflicting Peds, #/hr	0	0	0	0	0	0	0	0	0	0	0	0
Sign Control	Free	Free	Free	Free	Free	Free	Stop	Stop	Stop	Stop	Stop	Stop
RT Channelized	-	-	None	-	-	None	-	-	None	-	-	None
Storage Length	100	-	-	100	-	-	-	-	-	-	-	-
Veh in Median Storage, #	-	0	-	-	0	-	-	0	-	-	0	-
Grade, %	-	0	-	-	0	-	-	0	-	-	0	-
Peak Hour Factor	92	92	92	92	92	92	92	92	92	92	92	92
Heavy Vehicles, %	2	2	2	2	2	2	2	2	2	2	2	2
Mvmt Flow	55	222	13	20	192	7	10	0	20	26	0	130

Major/Minor	Major1			Major2			Minor1			Minor2		
Conflicting Flow All	199	0	0	235	0	0	640	578	229	585	581	196
Stage 1	-	-	-	-	-	-	339	339	-	236	236	-
Stage 2	-	-	-	-	-	-	301	239	-	349	345	-
Critical Hdwy	4.12	-	-	4.12	-	-	7.12	6.52	6.22	7.12	6.52	6.22
Critical Hdwy Stg 1	-	-	-	-	-	-	6.12	5.52	-	6.12	5.52	-
Critical Hdwy Stg 2	-	-	-	-	-	-	6.12	5.52	-	6.12	5.52	-
Follow-up Hdwy	2.218	-	-	2.218	-	-	3.518	4.018	3.318	3.518	4.018	3.318
Pot Cap-1 Maneuver	1373	-	-	1366	-	-	417	449	918	460	446	845
Stage 1	-	-	-	-	-	-	739	668	-	767	710	-
Stage 2	-	-	-	-	-	-	708	708	-	729	663	-
Platoon blocked, %		-	-	1	-	-	1	1	1	1	1	
Mov Cap-1 Maneuver	1373	-	-	1366	-	-	338	425	918	431	422	845
Mov Cap-2 Maneuver	-	-	-	-	-	-	338	425	-	431	422	-
Stage 1	-	-	-	-	-	-	710	641	-	736	699	-
Stage 2	-	-	-	-	-	-	590	697	-	685	636	-

Approach	EB			WB			NB			SB		
HCM Control Delay, s	1.5			0.7			11.5			11.3		
HCM LOS							B			B		

Minor Lane/Major Mvmt	NBLn1	EBL	EBT	EBR	WBL	WBT	WBR	SBLn1
Capacity (veh/h)	584	1373	-	-	1366	-	-	728
HCM Lane V/C Ratio	0.05	0.04	-	-	0.014	-	-	0.215
HCM Control Delay (s)	11.5	7.7	-	-	7.7	-	-	11.3
HCM Lane LOS	B	A	-	-	A	-	-	B
HCM 95th %tile Q(veh)	0.2	0.1	-	-	0	-	-	0.8

Intersection	
Intersection Delay, s/veh	10.1
Intersection LOS	B

Movement	EBL	EBT	EBR	WBL	WBT	WBR	NBL	NBT	NBR	SBL	SBT	SBR
Lane Configurations	↶	↷		↶	↷		↶	↷		↶	↷	
Traffic Vol, veh/h	120	56	46	43	66	4	62	102	18	9	110	50
Future Vol, veh/h	120	56	46	43	66	4	62	102	18	9	110	50
Peak Hour Factor	0.92	0.92	0.92	0.92	0.92	0.92	0.92	0.92	0.92	0.92	0.92	0.92
Heavy Vehicles, %	2	2	2	2	2	2	2	2	2	2	2	2
Mvmt Flow	130	61	50	47	72	4	67	111	20	10	120	54
Number of Lanes	1	1	0	1	1	0	1	1	0	1	1	0

Approach	EB	WB	NB	SB
Opposing Approach	WB	EB	SB	NB
Opposing Lanes	2	2	2	2
Conflicting Approach Left	SB	NB	EB	WB
Conflicting Lanes Left	2	2	2	2
Conflicting Approach Right	NB	SB	WB	EB
Conflicting Lanes Right	2	2	2	2
HCM Control Delay	10.2	9.6	10	10.4
HCM LOS	B	A	A	B

Lane	NBLn1	NBLn2	EBLn1	EBLn2	WBLn1	WBLn2	SBLn1	SBLn2
Vol Left, %	100%	0%	100%	0%	100%	0%	100%	0%
Vol Thru, %	0%	85%	0%	55%	0%	94%	0%	69%
Vol Right, %	0%	15%	0%	45%	0%	6%	0%	31%
Sign Control	Stop	Stop	Stop	Stop	Stop	Stop	Stop	Stop
Traffic Vol by Lane	62	120	120	102	43	70	9	160
LT Vol	62	0	120	0	43	0	9	0
Through Vol	0	102	0	56	0	66	0	110
RT Vol	0	18	0	46	0	4	0	50
Lane Flow Rate	67	130	130	111	47	76	10	174
Geometry Grp	7	7	7	7	7	7	7	7
Degree of Util (X)	0.119	0.208	0.229	0.169	0.084	0.126	0.017	0.273
Departure Headway (Hd)	6.352	5.741	6.315	5.491	6.488	5.941	6.382	5.656
Convergence, Y/N	Yes	Yes	Yes	Yes	Yes	Yes	Yes	Yes
Cap	565	626	570	654	553	604	562	637
Service Time	4.076	3.464	4.038	3.214	4.215	3.668	4.107	3.38
HCM Lane V/C Ratio	0.119	0.208	0.228	0.17	0.085	0.126	0.018	0.273
HCM Control Delay	9.9	10	10.9	9.3	9.8	9.5	9.2	10.5
HCM Lane LOS	A	A	B	A	A	A	A	B
HCM 95th-tile Q	0.4	0.8	0.9	0.6	0.3	0.4	0.1	1.1

15: 73rd Street/Dial Boulevard & Greenway Hayden Loop

08/18/2022

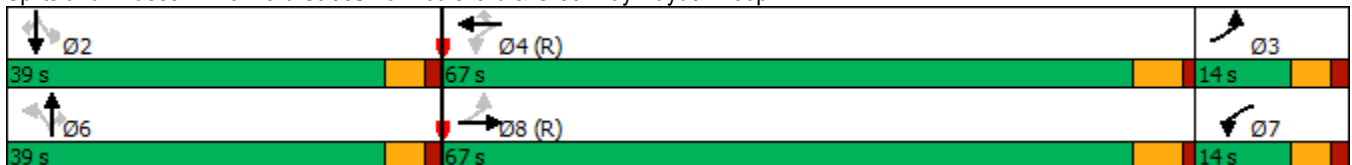


Lane Group	EBL	EBT	WBL	WBT	WBR	NBL	NBT	NBR	SBL	SBT	SBR
Lane Configurations	↘	↕↕↕	↘	↕↕	↗	↘	↕	↗	↘	↕	↗
Traffic Volume (vph)	99	549	206	787	82	106	93	383	56	81	139
Future Volume (vph)	99	549	206	787	82	106	93	383	56	81	139
Turn Type	pm+pt	NA	pm+pt	NA	Perm	Perm	NA	Perm	Perm	NA	Perm
Protected Phases	3	8	7	4			6			2	
Permitted Phases	8		4		4	6		6	2		2
Detector Phase	3	8	7	4	4	6	6	6	2	2	2
Switch Phase											
Minimum Initial (s)	5.0	10.0	5.0	10.0	10.0	7.0	7.0	7.0	7.0	7.0	7.0
Minimum Split (s)	12.0	37.0	37.0	36.0	36.0	37.0	37.0	37.0	37.0	37.0	37.0
Total Split (s)	14.0	67.0	14.0	67.0	67.0	39.0	39.0	39.0	39.0	39.0	39.0
Total Split (%)	11.7%	55.8%	11.7%	55.8%	55.8%	32.5%	32.5%	32.5%	32.5%	32.5%	32.5%
Yellow Time (s)	3.6	4.4	3.6	4.4	4.4	3.6	3.6	3.6	3.6	3.6	3.6
All-Red Time (s)	1.7	1.0	1.7	1.0	1.0	1.6	1.6	1.6	1.6	1.6	1.6
Lost Time Adjust (s)	0.0	0.0	0.0	0.0	0.0	0.0	0.0	0.0	0.0	0.0	0.0
Total Lost Time (s)	5.3	5.4	5.3	5.4	5.4	5.2	5.2	5.2	5.2	5.2	5.2
Lead/Lag	Lag	Lead	Lag	Lead	Lead						
Lead-Lag Optimize?	Yes	Yes	Yes	Yes	Yes						
Recall Mode	None	C-Min	None	C-Min	C-Min	None	None	None	None	None	None
Act Effct Green (s)	81.7	75.9	92.5	82.0	82.0	16.4	16.4	16.4	16.4	16.4	16.4
Actuated g/C Ratio	0.68	0.63	0.77	0.68	0.68	0.14	0.14	0.14	0.14	0.14	0.14
v/c Ratio	0.25	0.21	0.34	0.35	0.08	0.65	0.40	0.81	0.37	0.35	0.44
Control Delay	8.7	5.7	4.7	12.1	4.2	64.8	49.9	22.4	50.9	48.5	10.4
Queue Delay	0.0	0.0	0.0	0.0	0.0	0.0	0.0	0.0	0.0	0.0	0.0
Total Delay	8.7	5.7	4.7	12.1	4.2	64.8	49.9	22.4	50.9	48.5	10.4
LOS	A	A	A	B	A	E	D	C	D	D	B
Approach Delay		6.1		10.1			34.5			29.8	
Approach LOS		A		B			C			C	

Intersection Summary

Cycle Length: 120
 Actuated Cycle Length: 120
 Offset: 111 (93%), Referenced to phase 4:WBTL and 8:EBTL, Start of Green
 Natural Cycle: 115
 Control Type: Actuated-Coordinated
 Maximum v/c Ratio: 0.81
 Intersection Signal Delay: 16.5
 Intersection Capacity Utilization 54.7%
 Analysis Period (min) 15
 Intersection LOS: B
 ICU Level of Service A

Splits and Phases: 15: 73rd Street/Dial Boulevard & Greenway Hayden Loop



15: 73rd Street/Dial Boulevard & Greenway Hayden Loop

08/18/2022



Movement	EBL	EBT	EBR	WBL	WBT	WBR	NBL	NBT	NBR	SBL	SBT	SBR
Lane Configurations	↖	↕↕↕		↖	↕↕	↖	↖	↕	↖	↖	↖	↖
Traffic Volume (veh/h)	99	549	61	206	787	82	106	93	383	56	81	139
Future Volume (veh/h)	99	549	61	206	787	82	106	93	383	56	81	139
Initial Q (Qb), veh	0	0	0	0	0	0	0	0	0	0	0	0
Ped-Bike Adj(A_pbT)	1.00		1.00	1.00		1.00	1.00		1.00	1.00		1.00
Parking Bus, Adj	1.00	1.00	1.00	1.00	1.00	1.00	1.00	1.00	1.00	1.00	1.00	1.00
Work Zone On Approach		No			No			No			No	
Adj Sat Flow, veh/h/ln	1870	1870	1870	1870	1870	1870	1870	1870	1870	1870	1870	1870
Adj Flow Rate, veh/h	108	597	66	224	855	89	115	101	416	61	88	151
Peak Hour Factor	0.92	0.92	0.92	0.92	0.92	0.92	0.92	0.92	0.92	0.92	0.92	0.92
Percent Heavy Veh, %	2	2	2	2	2	2	2	2	2	2	2	2
Cap, veh/h	610	794	87	831	1005	448	334	516	437	267	516	437
Arrive On Green	0.10	0.06	0.06	0.42	0.28	0.28	0.28	0.28	0.28	0.28	0.28	0.28
Sat Flow, veh/h	1781	4672	511	1781	3554	1585	1141	1870	1585	884	1870	1585
Grp Volume(v), veh/h	108	433	230	224	855	89	115	101	416	61	88	151
Grp Sat Flow(s),veh/h/ln	1781	1702	1778	1781	1777	1585	1141	1870	1585	884	1870	1585
Q Serve(g_s), s	2.5	15.0	15.3	3.8	27.3	5.1	10.2	5.0	30.9	6.8	4.3	9.1
Cycle Q Clear(g_c), s	2.5	15.0	15.3	3.8	27.3	5.1	14.5	5.0	30.9	11.8	4.3	9.1
Prop In Lane	1.00		0.29	1.00		1.00	1.00		1.00	1.00		1.00
Lane Grp Cap(c), veh/h	610	578	302	831	1005	448	334	516	437	267	516	437
V/C Ratio(X)	0.18	0.75	0.76	0.27	0.85	0.20	0.34	0.20	0.95	0.23	0.17	0.35
Avail Cap(c_a), veh/h	610	1747	913	831	1824	814	341	527	446	272	527	446
HCM Platoon Ratio	0.33	0.33	0.33	1.00	1.00	1.00	1.00	1.00	1.00	1.00	1.00	1.00
Upstream Filter(I)	0.80	0.80	0.80	1.00	1.00	1.00	1.00	1.00	1.00	1.00	1.00	1.00
Uniform Delay (d), s/veh	37.7	54.1	54.2	20.4	40.6	32.7	38.5	33.3	42.7	37.8	33.0	34.8
Incr Delay (d2), s/veh	0.0	7.0	13.4	0.1	9.0	1.0	0.2	0.1	29.8	0.2	0.1	0.2
Initial Q Delay(d3),s/veh	0.0	0.0	0.0	0.0	0.0	0.0	0.0	0.0	0.0	0.0	0.0	0.0
%ile BackOfQ(50%),veh/ln	2.9	7.5	8.5	3.8	13.1	2.1	2.9	2.3	15.6	1.5	2.0	3.6
Unsig. Movement Delay, s/veh												
LnGrp Delay(d),s/veh	37.7	61.1	67.7	20.4	49.6	33.7	38.7	33.3	72.4	37.9	33.1	34.9
LnGrp LOS	D	E	E	C	D	C	D	C	E	D	C	C
Approach Vol, veh/h		771			1168			632			300	
Approach Delay, s/veh		59.8			42.8			60.0			35.0	
Approach LOS		E			D			E			C	
Timer - Assigned Phs		2	3	4		6	7	8				
Phs Duration (G+Y+Rc), s		38.3	42.4	39.3		38.3	55.9	25.8				
Change Period (Y+Rc), s		* 5.2	5.3	* 5.4		* 5.2	5.3	* 5.4				
Max Green Setting (Gmax), s		* 34	8.7	* 62		* 34	8.7	* 62				
Max Q Clear Time (g_c+I1), s		13.8	4.5	29.3		32.9	5.8	17.3				
Green Ext Time (p_c), s		0.7	0.0	4.7		0.2	0.1	3.1				

Intersection Summary

HCM 6th Ctrl Delay	50.4
HCM 6th LOS	D

Notes

User approved pedestrian interval to be less than phase max green.
 * HCM 6th computational engine requires equal clearance times for the phases crossing the barrier.

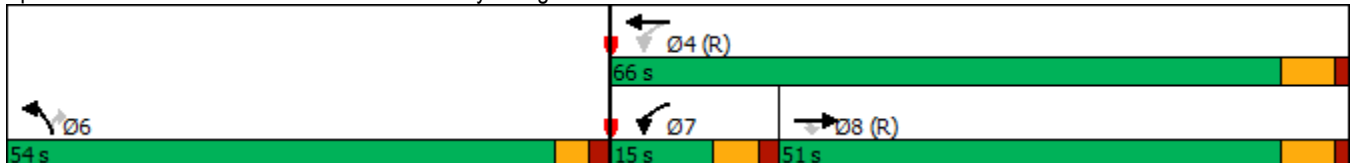


Lane Group	EBT	EBR	WBL	WBT	NBL	NBR
Lane Configurations	↑↑↑	↑	↓	↑↑↑	↓	↓
Traffic Volume (vph)	1281	104	236	1695	162	399
Future Volume (vph)	1281	104	236	1695	162	399
Turn Type	NA	Perm	pm+pt	NA	Prot	Perm
Protected Phases	8		7	4	6	
Permitted Phases		8	4			6
Detector Phase	8	8	7	4	6	6
Switch Phase						
Minimum Initial (s)	7.0	7.0	5.0	10.0	7.0	7.0
Minimum Split (s)	13.2	13.2	11.0	16.2	12.0	12.0
Total Split (s)	51.0	51.0	15.0	66.0	54.0	54.0
Total Split (%)	42.5%	42.5%	12.5%	55.0%	45.0%	45.0%
Yellow Time (s)	4.7	4.7	4.0	4.7	3.0	3.0
All-Red Time (s)	1.5	1.5	1.9	1.5	2.0	2.0
Lost Time Adjust (s)	0.0	0.0	0.0	0.0	0.0	0.0
Total Lost Time (s)	6.2	6.2	5.9	6.2	5.0	5.0
Lead/Lag	Lag	Lag	Lead			
Lead-Lag Optimize?	Yes	Yes	Yes			
Recall Mode	C-Min	C-Min	None	C-Min	None	None
Act Effct Green (s)	53.1	53.1	82.9	82.6	26.2	26.2
Actuated g/C Ratio	0.44	0.44	0.69	0.69	0.22	0.22
v/c Ratio	0.62	0.15	0.58	0.53	0.23	0.88
Control Delay	36.7	19.7	18.3	22.9	37.1	43.6
Queue Delay	0.0	0.0	0.0	0.0	0.0	0.0
Total Delay	36.7	19.7	18.3	22.9	37.1	43.6
LOS	D	B	B	C	D	D
Approach Delay	35.5			22.3	41.7	
Approach LOS	D			C	D	

Intersection Summary

Cycle Length: 120
 Actuated Cycle Length: 120
 Offset: 44 (37%), Referenced to phase 4:WBTL and 8:EBT, Start of 1st Green
 Natural Cycle: 55
 Control Type: Actuated-Coordinated
 Maximum v/c Ratio: 0.88
 Intersection Signal Delay: 29.8
 Intersection Capacity Utilization 58.8%
 Analysis Period (min) 15
 Intersection LOS: C
 ICU Level of Service B

Splits and Phases: 16: 76th Street & Frank Lloyd Wright Boulevard





Movement	EBT	EBR	WBL	WBT	NBL	NBR	
Lane Configurations	↑↑↑	↑	↓	↑↑↑	↓	↑	
Traffic Volume (veh/h)	1281	104	236	1695	162	399	
Future Volume (veh/h)	1281	104	236	1695	162	399	
Initial Q (Qb), veh	0	0	0	0	0	0	
Ped-Bike Adj(A_pbT)		1.00	1.00		1.00	1.00	
Parking Bus, Adj	1.00	1.00	1.00	1.00	1.00	1.00	
Work Zone On Approach	No			No	No		
Adj Sat Flow, veh/h/ln	1870	1870	1870	1870	1870	1870	
Adj Flow Rate, veh/h	1392	113	257	1842	176	434	
Peak Hour Factor	0.92	0.92	0.92	0.92	0.92	0.92	
Percent Heavy Veh, %	2	2	2	2	2	2	
Cap, veh/h	2497	775	313	3135	1011	464	
Arrive On Green	0.65	0.65	0.15	1.00	0.29	0.29	
Sat Flow, veh/h	5274	1585	1781	5274	3456	1585	
Grp Volume(v), veh/h	1392	113	257	1842	176	434	
Grp Sat Flow(s),veh/h/ln	1702	1585	1781	1702	1728	1585	
Q Serve(g_s), s	17.9	3.3	9.1	0.0	4.6	32.0	
Cycle Q Clear(g_c), s	17.9	3.3	9.1	0.0	4.6	32.0	
Prop In Lane		1.00	1.00		1.00	1.00	
Lane Grp Cap(c), veh/h	2497	775	313	3135	1011	464	
V/C Ratio(X)	0.56	0.15	0.82	0.59	0.17	0.94	
Avail Cap(c_a), veh/h	2497	775	313	3135	1411	647	
HCM Platoon Ratio	1.33	1.33	2.00	2.00	1.00	1.00	
Upstream Filter(I)	0.75	0.75	0.49	0.49	1.00	1.00	
Uniform Delay (d), s/veh	13.9	11.3	16.8	0.0	31.6	41.3	
Incr Delay (d2), s/veh	0.7	0.3	7.8	0.4	0.0	14.7	
Initial Q Delay(d3),s/veh	0.0	0.0	0.0	0.0	0.0	0.0	
%ile BackOfQ(50%),veh/ln	5.4	1.2	3.5	0.1	1.9	26.6	
Unsig. Movement Delay, s/veh							
LnGrp Delay(d),s/veh	14.5	11.6	24.6	0.4	31.7	56.1	
LnGrp LOS	B	B	C	A	C	E	
Approach Vol, veh/h	1505			2099	610		
Approach Delay, s/veh	14.3			3.4	49.0		
Approach LOS	B			A	D		
Timer - Assigned Phs				4	6	7	8
Phs Duration (G+Y+Rc), s				79.9	40.1	15.0	64.9
Change Period (Y+Rc), s				6.2	5.0	* 5.9	6.2
Max Green Setting (Gmax), s				59.8	49.0	* 9.1	44.8
Max Q Clear Time (g_c+I1), s				2.0	34.0	11.1	19.9
Green Ext Time (p_c), s				2.6	1.1	0.0	1.7

Intersection Summary

HCM 6th Ctrl Delay	13.9
HCM 6th LOS	B

Notes

User approved pedestrian interval to be less than phase max green.
 * HCM 6th computational engine requires equal clearance times for the phases crossing the barrier.

Intersection

Intersection Delay, s/veh 12.6

Intersection LOS B

Movement	EBL	EBT	EBR	WBL	WBT	WBR	NBL	NBT	NBR	SBL	SBT	SBR
Lane Configurations												
Traffic Vol, veh/h	165	100	12	7	200	62	18	157	18	16	83	52
Future Vol, veh/h	165	100	12	7	200	62	18	157	18	16	83	52
Peak Hour Factor	0.92	0.92	0.92	0.92	0.92	0.92	0.92	0.92	0.92	0.92	0.92	0.92
Heavy Vehicles, %	2	2	2	2	2	2	2	2	2	2	2	2
Mvmt Flow	179	109	13	8	217	67	20	171	20	17	90	57
Number of Lanes	1	1	0	1	1	0	1	1	0	1	1	0

Approach	EB	WB	NB	SB
Opposing Approach	WB	EB	SB	NB
Opposing Lanes	2	2	2	2
Conflicting Approach Left	SB	NB	EB	WB
Conflicting Lanes Left	2	2	2	2
Conflicting Approach Right	NB	SB	WB	EB
Conflicting Lanes Right	2	2	2	2
HCM Control Delay	11.9	14.2	12.5	11.3
HCM LOS	B	B	B	B

Lane	NBLn1	NBLn2	EBLn1	EBLn2	WBLn1	WBLn2	SBLn1	SBLn2
Vol Left, %	100%	0%	100%	0%	100%	0%	100%	0%
Vol Thru, %	0%	90%	0%	89%	0%	76%	0%	61%
Vol Right, %	0%	10%	0%	11%	0%	24%	0%	39%
Sign Control	Stop	Stop	Stop	Stop	Stop	Stop	Stop	Stop
Traffic Vol by Lane	18	175	165	112	7	262	16	135
LT Vol	18	0	165	0	7	0	16	0
Through Vol	0	157	0	100	0	200	0	83
RT Vol	0	18	0	12	0	62	0	52
Lane Flow Rate	20	190	179	122	8	285	17	147
Geometry Grp	7	7	7	7	7	7	7	7
Degree of Util (X)	0.038	0.343	0.334	0.207	0.014	0.478	0.035	0.261
Departure Headway (Hd)	7.081	6.499	6.695	6.111	6.722	6.046	7.183	6.399
Convergence, Y/N	Yes	Yes	Yes	Yes	Yes	Yes	Yes	Yes
Cap	504	552	536	584	531	592	496	559
Service Time	4.85	4.268	4.457	3.874	4.484	3.808	4.956	4.171
HCM Lane V/C Ratio	0.04	0.344	0.334	0.209	0.015	0.481	0.034	0.263
HCM Control Delay	10.1	12.7	12.8	10.5	9.6	14.3	10.2	11.4
HCM Lane LOS	B	B	B	B	A	B	B	B
HCM 95th-tile Q	0.1	1.5	1.5	0.8	0	2.6	0.1	1

18: Greenway Hayden Loop & Frank Lloyd Wright Boulevard

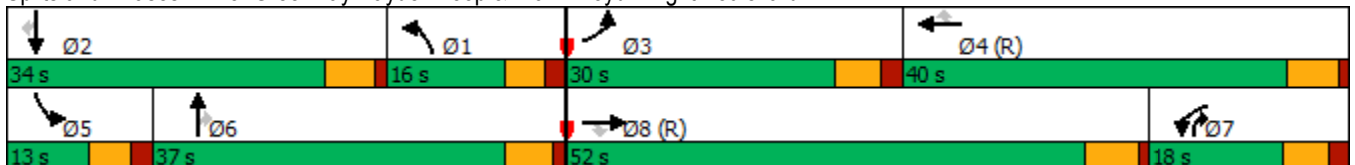
08/18/2022

Lane Group	EBL	EBT	EBR	WBL	WBT	WBR	NBL	NBT	NBR	SBL	SBT	SBR
Lane Configurations												
Traffic Volume (vph)	446	1434	48	555	1453	387	56	635	706	167	519	413
Future Volume (vph)	446	1434	48	555	1453	387	56	635	706	167	519	413
Turn Type	Prot	NA	Perm	Prot	NA	Perm	Prot	NA	pm+ov	Prot	NA	Perm
Protected Phases	3	8		7	4		1	6	7	5	2	
Permitted Phases			8			4			6			2
Detector Phase	3	8	8	7	4	4	1	6	7	5	2	2
Switch Phase												
Minimum Initial (s)	5.0	10.0	10.0	5.0	10.0	10.0	5.0	7.0	5.0	5.0	7.0	7.0
Minimum Split (s)	11.0	15.9	15.9	11.0	15.9	15.9	11.0	13.0	11.0	11.0	13.0	13.0
Total Split (s)	30.0	52.0	52.0	18.0	40.0	40.0	16.0	37.0	18.0	13.0	34.0	34.0
Total Split (%)	25.0%	43.3%	43.3%	15.0%	33.3%	33.3%	13.3%	30.8%	15.0%	10.8%	28.3%	28.3%
Yellow Time (s)	4.0	4.7	4.7	4.0	4.7	4.7	3.6	4.4	4.0	3.6	4.4	4.4
All-Red Time (s)	2.0	1.0	1.0	2.0	1.0	1.0	2.0	1.2	2.0	2.0	1.2	1.2
Lost Time Adjust (s)	0.0	0.0	0.0	0.0	0.0	0.0	0.0	0.0	0.0	0.0	0.0	0.0
Total Lost Time (s)	6.0	5.7	5.7	6.0	5.7	5.7	5.6	5.6	6.0	5.6	5.6	5.6
Lead/Lag	Lead	Lead	Lead	Lag	Lag	Lag	Lag	Lag	Lag	Lead	Lead	Lead
Lead-Lag Optimize?	Yes	Yes	Yes	Yes	Yes	Yes	Yes	Yes	Yes	Yes	Yes	Yes
Recall Mode	None	C-Min	C-Min	None	C-Min	C-Min	None	None	None	None	None	None
Act Effct Green (s)	20.0	44.2	44.2	18.9	43.1	43.1	9.8	26.6	45.1	7.4	26.3	26.3
Actuated g/C Ratio	0.17	0.37	0.37	0.16	0.36	0.36	0.08	0.22	0.38	0.06	0.22	0.22
v/c Ratio	0.85	0.83	0.07	1.11	0.86	0.62	0.43	0.88	1.14	0.86	0.73	0.64
Control Delay	66.7	54.7	1.8	120.6	42.8	23.5	63.6	61.4	105.5	90.5	50.0	8.3
Queue Delay	0.0	0.0	0.0	0.0	0.0	0.0	0.0	0.0	0.0	0.0	0.0	0.0
Total Delay	66.7	54.7	1.8	120.6	42.8	23.5	63.6	61.4	105.5	90.5	50.0	8.3
LOS	E	D	A	F	D	C	E	E	F	F	D	A
Approach Delay		56.2			57.7			83.8			40.5	
Approach LOS		E			E			F			D	

Intersection Summary

Cycle Length: 120
 Actuated Cycle Length: 120
 Offset: 38 (32%), Referenced to phase 4:WBT and 8:EBT, Start of 1st Green
 Natural Cycle: 110
 Control Type: Actuated-Coordinated
 Maximum v/c Ratio: 1.14
 Intersection Signal Delay: 59.8
 Intersection Capacity Utilization 90.6%
 Analysis Period (min) 15
 Intersection LOS: E
 ICU Level of Service E

Splits and Phases: 18: Greenway Hayden Loop & Frank Lloyd Wright Boulevard



18: Greenway Hayden Loop & Frank Lloyd Wright Boulevard

08/18/2022



Movement	EBL	EBT	EBR	WBL	WBT	WBR	NBL	NBT	NBR	SBL	SBT	SBR
Lane Configurations												
Traffic Volume (veh/h)	446	1434	48	555	1453	387	56	635	706	167	519	413
Future Volume (veh/h)	446	1434	48	555	1453	387	56	635	706	167	519	413
Initial Q (Qb), veh	0	0	0	0	0	0	0	0	0	0	0	0
Ped-Bike Adj(A_pbT)	1.00		1.00	1.00		1.00	1.00		1.00	1.00		1.00
Parking Bus, Adj	1.00	1.00	1.00	1.00	1.00	1.00	1.00	1.00	1.00	1.00	1.00	1.00
Work Zone On Approach		No			No			No			No	
Adj Sat Flow, veh/h/ln	1870	1870	1870	1870	1870	1870	1870	1870	1870	1870	1870	1870
Adj Flow Rate, veh/h	485	1559	52	603	1579	421	61	690	767	182	564	449
Peak Hour Factor	0.92	0.92	0.92	0.92	0.92	0.92	0.92	0.92	0.92	0.92	0.92	0.92
Percent Heavy Veh, %	2	2	2	2	2	2	2	2	2	2	2	2
Cap, veh/h	546	1751	544	645	1885	585	176	775	641	213	643	287
Arrive On Green	0.05	0.11	0.11	0.19	0.37	0.37	0.10	0.22	0.22	0.06	0.18	0.18
Sat Flow, veh/h	3456	5106	1585	3456	5106	1585	1781	3554	1585	3456	3554	1585
Grp Volume(v), veh/h	485	1559	52	603	1579	421	61	690	767	182	564	449
Grp Sat Flow(s),veh/h/ln	1728	1702	1585	1728	1702	1585	1781	1777	1585	1728	1777	1585
Q Serve(g_s), s	16.7	36.1	3.5	20.6	33.9	27.4	3.8	22.6	18.3	6.3	18.5	15.0
Cycle Q Clear(g_c), s	16.7	36.1	3.5	20.6	33.9	27.4	3.8	22.6	18.3	6.3	18.5	15.0
Prop In Lane	1.00		1.00	1.00		1.00	1.00		1.00	1.00		1.00
Lane Grp Cap(c), veh/h	546	1751	544	645	1885	585	176	775	641	213	643	287
V/C Ratio(X)	0.89	0.89	0.10	0.93	0.84	0.72	0.35	0.89	1.20	0.85	0.88	1.57
Avail Cap(c_a), veh/h	691	1970	612	645	1885	585	176	930	711	213	841	375
HCM Platoon Ratio	0.33	0.33	0.33	1.00	1.00	1.00	1.00	1.00	1.00	1.00	1.00	1.00
Upstream Filter(I)	0.68	0.68	0.68	1.00	1.00	1.00	1.00	1.00	1.00	1.00	1.00	1.00
Uniform Delay (d), s/veh	55.8	51.0	36.5	48.1	34.6	32.5	50.5	45.5	19.1	55.8	47.8	23.3
Incr Delay (d2), s/veh	7.1	5.1	0.2	20.7	4.6	7.5	0.4	8.5	102.9	25.9	7.0	270.7
Initial Q Delay(d3),s/veh	0.0	0.0	0.0	0.0	0.0	0.0	0.0	0.0	0.0	0.0	0.0	0.0
%ile BackOfQ(50%),veh/ln	8.3	17.2	1.4	10.5	14.1	11.2	1.7	10.7	22.5	3.4	8.7	26.9
Unsig. Movement Delay, s/veh												
LnGrp Delay(d),s/veh	62.9	56.1	36.8	68.8	39.2	40.0	50.9	54.0	121.9	81.7	54.8	294.1
LnGrp LOS	E	E	D	E	D	D	D	D	F	F	D	F
Approach Vol, veh/h		2096			2603			1518			1195	
Approach Delay, s/veh		57.2			46.2			88.2			148.8	
Approach LOS		E			D			F			F	
Timer - Assigned Phs	1	2	3	4	5	6	7	8				
Phs Duration (G+Y+Rc), s	17.4	27.3	25.0	50.3	13.0	31.8	28.4	46.8				
Change Period (Y+Rc), s	* 5.6	5.6	6.0	* 6	5.6	* 5.6	6.0	5.7				
Max Green Setting (Gmax), s	* 10	28.4	24.0	* 34	7.4	* 31	12.0	46.3				
Max Q Clear Time (g_c+I1), s	5.8	20.5	18.7	35.9	8.3	24.6	22.6	38.1				
Green Ext Time (p_c), s	0.0	1.2	0.2	0.0	0.0	1.5	0.0	3.0				

Intersection Summary

HCM 6th Ctrl Delay	74.5
HCM 6th LOS	E

Notes

- User approved pedestrian interval to be less than phase max green.
- * HCM 6th computational engine requires equal clearance times for the phases crossing the barrier.

Intersection												
Int Delay, s/veh	10.1											
Movement	EBL	EBT	EBR	WBL	WBT	WBR	NBL	NBT	NBR	SBL	SBT	SBR
Lane Configurations		↕	↗		↕	↗	↖	↕	↗	↖	↕	↗
Traffic Vol, veh/h	65	1	23	23	1	71	28	1243	32	33	981	136
Future Vol, veh/h	65	1	23	23	1	71	28	1243	32	33	981	136
Conflicting Peds, #/hr	0	0	0	0	0	0	0	0	0	0	0	0
Sign Control	Stop	Stop	Stop	Stop	Stop	Stop	Free	Free	Free	Free	Free	Free
RT Channelized	-	-	None	-	-	None	-	-	None	-	-	None
Storage Length	-	-	130	-	-	130	150	-	-	110	-	175
Veh in Median Storage, #	-	0	-	-	0	-	-	0	-	-	0	-
Grade, %	-	0	-	-	0	-	-	0	-	-	0	-
Peak Hour Factor	92	92	92	92	92	92	92	92	92	92	92	92
Heavy Vehicles, %	2	2	2	2	2	2	2	2	2	2	2	2
Mvmt Flow	71	1	25	25	1	77	30	1351	35	36	1066	148

Major/Minor	Minor2		Minor1		Major1			Major2				
Conflicting Flow All	1874	2584	533	2017	2697	676	1214	0	0	1386	0	0
Stage 1	1138	1138	-	1411	1411	-	-	-	-	-	-	-
Stage 2	736	1446	-	606	1286	-	-	-	-	-	-	-
Critical Hdwy	7.54	6.54	6.94	7.54	6.54	6.94	4.14	-	-	4.14	-	-
Critical Hdwy Stg 1	6.54	5.54	-	6.54	5.54	-	-	-	-	-	-	-
Critical Hdwy Stg 2	6.54	5.54	-	6.54	5.54	-	-	-	-	-	-	-
Follow-up Hdwy	3.52	4.02	3.32	3.52	4.02	3.32	2.22	-	-	2.22	-	-
Pot Cap-1 Maneuver	86	23	*685	*59	18	396	884	-	-	490	-	-
Stage 1	601	537	-	*145	203	-	-	-	-	-	-	-
Stage 2	377	195	-	*645	425	-	-	-	-	-	-	-
Platoon blocked, %	1	1	1	1	1	1	1	-	-	-	-	-
Mov Cap-1 Maneuver	~ 60	20	*685	*50	16	396	884	-	-	490	-	-
Mov Cap-2 Maneuver	~ 60	20	-	*50	16	-	-	-	-	-	-	-
Stage 1	581	498	-	*140	196	-	-	-	-	-	-	-
Stage 2	292	188	-	*575	394	-	-	-	-	-	-	-

Approach	EB	WB	NB	SB
HCM Control Delay, s	235.3	52	0.2	0.4
HCM LOS	F	F		

Minor Lane/Major Mvmt	NBL	NBT	NBR	EBLn1	EBLn2	WBLn1	WBLn2	SBL	SBT	SBR
Capacity (veh/h)	884	-	-	58	685	46	396	490	-	-
HCM Lane V/C Ratio	0.034	-	-	1.237	0.036	0.567	0.195	0.073	-	-
HCM Control Delay (s)	9.2	-	-	\$ 313.7	10.5	157.5	16.3	12.9	-	-
HCM Lane LOS	A	-	-	F	B	F	C	B	-	-
HCM 95th %tile Q(veh)	0.1	-	-	6.1	0.1	2.1	0.7	0.2	-	-

Notes
 ~: Volume exceeds capacity \$: Delay exceeds 300s +: Computation Not Defined *: All major volume in platoon



Appendix M – Traffic Signal Warrant Analysis

Warrants Summary Report

1: Greenway Hayden Loop & Paradise Lane

Intersection Information

	Major Street	Minor Street
Street Name	Greenway Hayden Loop	Paradise Lane
Direction	NB/SB	EB/WB
Number of Lanes	2	2
Approach Speed	40	30

Warrant	Met?	Notes
Warrant 1, Eight-Hour Vehicular Volume		
	No	
Condition A or B Met?	No	1 Hours met (8 required)
Condition A and B Met?	No	0 Hours met (8 required)
Warrant 2, Four-Hour Vehicular Volume		
	No	0 Hours met (4 required)
Warrant 3, Peak Hour		
	No	
Condition A Met?	No	0 Hours met (1 required)
Condition B Met?	No	0 Hours met (1 required)
Warrant 4, Pedestrian Volume		
	No	
Condition A Met?	No	0 Hours met (4 required)
Condition B Met?	No	0 Hours met (1 required)
Warrant 5, School Crossing		
	No	

Warrants Summary Report

1: Scottsdale Road & Tierra Buena Lane (4)

Intersection Information

	Major Street	Minor Street
Street Name	Scottsdale Road	Tierra Buena Lane
Direction	NB/SB	EB/WB
Number of Lanes	2	2
Approach Speed	45	30

Warrant	Met?	Notes
Warrant 1, Eight-Hour Vehicular Volume		
	Yes	
Condition A or B Met?	Yes	15 Hours met (8 required)
Condition A and B Met?	Yes	13 Hours met (8 required)
Warrant 2, Four-Hour Vehicular Volume		
	Yes	15 Hours met (4 required)
Warrant 3, Peak Hour		
	Yes	
Condition A Met?	No	0 Hours met (1 required)
Condition B Met?	Yes	14 Hours met (1 required)
Warrant 4, Pedestrian Volume		
	No	
Condition A Met?	No	0 Hours met (4 required)
Condition B Met?	No	0 Hours met (1 required)
Warrant 5, School Crossing		
	No	

Warrant 6, Coordinated Signal System

No

Warrant 7, Crash Experience

No

Traffic Volume Condi Yes 16 Hours met (8 required)

Ped Condition? No 0 Hours met (8 required)

Warrant 8, Roadway Network

Yes

Warrant 9, Intersection Near a Grade Crossing

No

AWSC Warrant, Multiway Stop Application

Yes

Condition A Met? Yes

Condition B Met? No

Condition C Met? No

Warrant 1: Eight-hour Vehicular Volume

1: Scottsdale Road & Tierra Buena Lane (4)

Intersection Information

Major Street Name: Scottsdale Road

Major Street Direction: NB/SB

Minor Street Direction: EB/WB

WARRANT 1 MET? Yes

Details:

Condition A Met? **Yes** 15 Hours met (8 required)

Condition B Met? **Yes** 13 Hours met (8 required)

Hour	Major Street Vehicles (Total of Both Approaches)	High Volume Minor Approach Vehicles	70% Standard Met? Cond. A OR Cond. B		56% Standard Met? Cond. A AND Cond. B	
			Condition A 70% Column	Condition B 70% Column	Condition A 56% Column	Condition B 56% Column
00:00 to 01:00	166	13	No	No	No	No
Condition A	Volume >= 70% column (420)?	No	Volume >= 70% column (630)?	No		
	Volume >= 56% column (336)?	No	Volume >= 56% column (504)?	No		
Condition B	Volume >= 70% column (630)?	No	Volume >= 70% column (70)?	No		
	Volume >= 56% column (504)?	No	Volume >= 56% column (56)?	No		
01:00 to 02:00	100	11	No	No	No	No
Condition A	Volume >= 70% column (420)?	No	Volume >= 70% column (630)?	No		
	Volume >= 56% column (336)?	No	Volume >= 56% column (504)?	No		
Condition B	Volume >= 70% column (630)?	No	Volume >= 70% column (70)?	No		
	Volume >= 56% column (504)?	No	Volume >= 56% column (56)?	No		
02:00 to 03:00	61	1	No	No	No	No
Condition A	Volume >= 70% column (420)?	No	Volume >= 70% column (630)?	No		
	Volume >= 56% column (336)?	No	Volume >= 56% column (504)?	No		
Condition B	Volume >= 70% column (630)?	No	Volume >= 70% column (70)?	No		
	Volume >= 56% column (504)?	No	Volume >= 56% column (56)?	No		
03:00 to 04:00	78	5	No	No	No	No
Condition A	Volume >= 70% column (420)?	No	Volume >= 70% column (630)?	No		
	Volume >= 56% column (336)?	No	Volume >= 56% column (504)?	No		
Condition B	Volume >= 70% column (630)?	No	Volume >= 70% column (70)?	No		
	Volume >= 56% column (504)?	No	Volume >= 56% column (56)?	No		

04:00 to 05:00	240		15	No	No	No	No
Condition A	Volume >= 70% column (420)?	No	Volume >= 70% column (630)?	No			
	Volume >= 56% column (336)?	No	Volume >= 56% column (504)?	No			
Condition B	Volume >= 70% column (630)?	No	Volume >= 70% column (70)?	No			
	Volume >= 56% column (504)?	No	Volume >= 56% column (56)?	No			

05:00 to 06:00	678		35	No	No	No	No
Condition A	Volume >= 70% column (420)?	Yes	Volume >= 70% column (630)?	No			
	Volume >= 56% column (336)?	Yes	Volume >= 56% column (504)?	No			
Condition B	Volume >= 70% column (630)?	Yes	Volume >= 70% column (70)?	No			
	Volume >= 56% column (504)?	Yes	Volume >= 56% column (56)?	No			

06:00 to 07:00	1,163		102	No	Yes*	No	Yes
Condition A	Volume >= 70% column (420)?	Yes	Volume >= 70% column (630)?	No			
	Volume >= 56% column (336)?	Yes	Volume >= 56% column (504)?	No			
Condition B	Volume >= 70% column (630)?	Yes	Volume >= 70% column (70)?	Yes			
	Volume >= 56% column (504)?	Yes	Volume >= 56% column (56)?	Yes			

07:00 to 08:00	2,155		282	Yes*	Yes*	Yes*	Yes*
Condition A	Volume >= 70% column (420)?	Yes	Volume >= 70% column (630)?	Yes			
	Volume >= 56% column (336)?	Yes	Volume >= 56% column (504)?	Yes			
Condition B	Volume >= 70% column (630)?	Yes	Volume >= 70% column (70)?	Yes			
	Volume >= 56% column (504)?	Yes	Volume >= 56% column (56)?	Yes			

08:00 to 09:00	2,461		181	Yes*	Yes*	Yes*	Yes*
Condition A	Volume >= 70% column (420)?	Yes	Volume >= 70% column (630)?	Yes			
	Volume >= 56% column (336)?	Yes	Volume >= 56% column (504)?	Yes			
Condition B	Volume >= 70% column (630)?	Yes	Volume >= 70% column (70)?	Yes			
	Volume >= 56% column (504)?	Yes	Volume >= 56% column (56)?	Yes			

09:00 to 10:00	2,408		145	Yes*	Yes*	Yes*	Yes*
Condition A	Volume >= 70% column (420)?	Yes	Volume >= 70% column (630)?	Yes			
	Volume >= 56% column (336)?	Yes	Volume >= 56% column (504)?	Yes			
Condition B	Volume >= 70% column (630)?	Yes	Volume >= 70% column (70)?	Yes			
	Volume >= 56% column (504)?	Yes	Volume >= 56% column (56)?	Yes			

10:00 to 11:00	2,603	139	No	Yes*	Yes*	Yes*
Condition A	Volume >= 70% column (420)?	Yes	Volume >= 70% column (630)?	No		
	Volume >= 56% column (336)?	Yes	Volume >= 56% column (504)?	Yes		
Condition B	Volume >= 70% column (630)?	Yes	Volume >= 70% column (70)?	Yes		
	Volume >= 56% column (504)?	Yes	Volume >= 56% column (56)?	Yes		

11:00 to 12:00	3,034	199	Yes*	Yes*	Yes*	Yes*
Condition A	Volume >= 70% column (420)?	Yes	Volume >= 70% column (630)?	Yes		
	Volume >= 56% column (336)?	Yes	Volume >= 56% column (504)?	Yes		
Condition B	Volume >= 70% column (630)?	Yes	Volume >= 70% column (70)?	Yes		
	Volume >= 56% column (504)?	Yes	Volume >= 56% column (56)?	Yes		

12:00 to 13:00	3,172	242	Yes*	Yes*	Yes*	Yes*
Condition A	Volume >= 70% column (420)?	Yes	Volume >= 70% column (630)?	Yes		
	Volume >= 56% column (336)?	Yes	Volume >= 56% column (504)?	Yes		
Condition B	Volume >= 70% column (630)?	Yes	Volume >= 70% column (70)?	Yes		
	Volume >= 56% column (504)?	Yes	Volume >= 56% column (56)?	Yes		

13:00 to 14:00	3,077	152	Yes*	Yes*	Yes*	Yes*
Condition A	Volume >= 70% column (420)?	Yes	Volume >= 70% column (630)?	Yes		
	Volume >= 56% column (336)?	Yes	Volume >= 56% column (504)?	Yes		
Condition B	Volume >= 70% column (630)?	Yes	Volume >= 70% column (70)?	Yes		
	Volume >= 56% column (504)?	Yes	Volume >= 56% column (56)?	Yes		

14:00 to 15:00	2,948	156	Yes*	Yes*	Yes*	Yes*
Condition A	Volume >= 70% column (420)?	Yes	Volume >= 70% column (630)?	Yes		
	Volume >= 56% column (336)?	Yes	Volume >= 56% column (504)?	Yes		
Condition B	Volume >= 70% column (630)?	Yes	Volume >= 70% column (70)?	Yes		
	Volume >= 56% column (504)?	Yes	Volume >= 56% column (56)?	Yes		

15:00 to 16:00	3,107	267	Yes*	Yes*	Yes*	Yes*
Condition A	Volume >= 70% column (420)?	Yes	Volume >= 70% column (630)?	Yes		
	Volume >= 56% column (336)?	Yes	Volume >= 56% column (504)?	Yes		
Condition B	Volume >= 70% column (630)?	Yes	Volume >= 70% column (70)?	Yes		
	Volume >= 56% column (504)?	Yes	Volume >= 56% column (56)?	Yes		

16:00 to 17:00	3,051	279	Yes*	Yes*	Yes*	Yes*
Condition A	Volume >= 70% column (420)?	Yes	Volume >= 70% column (630)?	Yes		
	Volume >= 56% column (336)?	Yes	Volume >= 56% column (504)?	Yes		
Condition B	Volume >= 70% column (630)?	Yes	Volume >= 70% column (70)?	Yes		
	Volume >= 56% column (504)?	Yes	Volume >= 56% column (56)?	Yes		

17:00 to 18:00	3,055	279	Yes*	Yes*	Yes*	Yes*
Condition A	Volume >= 70% column (420)?	Yes	Volume >= 70% column (630)?	Yes		
	Volume >= 56% column (336)?	Yes	Volume >= 56% column (504)?	Yes		
Condition B	Volume >= 70% column (630)?	Yes	Volume >= 70% column (70)?	Yes		
	Volume >= 56% column (504)?	Yes	Volume >= 56% column (56)?	Yes		

18:00 to 19:00	2,294	145	Yes*	Yes*	Yes*	Yes*
Condition A	Volume >= 70% column (420)?	Yes	Volume >= 70% column (630)?	Yes		
	Volume >= 56% column (336)?	Yes	Volume >= 56% column (504)?	Yes		
Condition B	Volume >= 70% column (630)?	Yes	Volume >= 70% column (70)?	Yes		
	Volume >= 56% column (504)?	Yes	Volume >= 56% column (56)?	Yes		

19:00 to 20:00	1,853	124	No	Yes*	Yes*	Yes*
Condition A	Volume >= 70% column (420)?	Yes	Volume >= 70% column (630)?	No		
	Volume >= 56% column (336)?	Yes	Volume >= 56% column (504)?	Yes		
Condition B	Volume >= 70% column (630)?	Yes	Volume >= 70% column (70)?	Yes		
	Volume >= 56% column (504)?	Yes	Volume >= 56% column (56)?	Yes		

20:00 to 21:00	1,404	83	No	Yes*	No	Yes
Condition A	Volume >= 70% column (420)?	Yes	Volume >= 70% column (630)?	No		
	Volume >= 56% column (336)?	Yes	Volume >= 56% column (504)?	No		
Condition B	Volume >= 70% column (630)?	Yes	Volume >= 70% column (70)?	Yes		
	Volume >= 56% column (504)?	Yes	Volume >= 56% column (56)?	Yes		

21:00 to 22:00	883	68	No	No	No	Yes
Condition A	Volume >= 70% column (420)?	Yes	Volume >= 70% column (630)?	No		
	Volume >= 56% column (336)?	Yes	Volume >= 56% column (504)?	No		
Condition B	Volume >= 70% column (630)?	Yes	Volume >= 70% column (70)?	No		
	Volume >= 56% column (504)?	Yes	Volume >= 56% column (56)?	Yes		

22:00 to 23:00		482	40	No	No	No	No
Condition A	Volume >= 70% column (420)?	Yes	Volume >= 70% column (630)?	No			
	Volume >= 56% column (336)?	Yes	Volume >= 56% column (504)?	No			
Condition B	Volume >= 70% column (630)?	No	Volume >= 70% column (70)?	No			
	Volume >= 56% column (504)?	No	Volume >= 56% column (56)?	No			

23:00 to 00:00		278	12	No	No	No	No
Condition A	Volume >= 70% column (420)?	No	Volume >= 70% column (630)?	No			
	Volume >= 56% column (336)?	No	Volume >= 56% column (504)?	No			
Condition B	Volume >= 70% column (630)?	No	Volume >= 70% column (70)?	No			
	Volume >= 56% column (504)?	No	Volume >= 56% column (56)?	No			

Warrant 2: Four-hour Vehicular Volume

1: Scottsdale Road & Tierra Buena Lane (4)

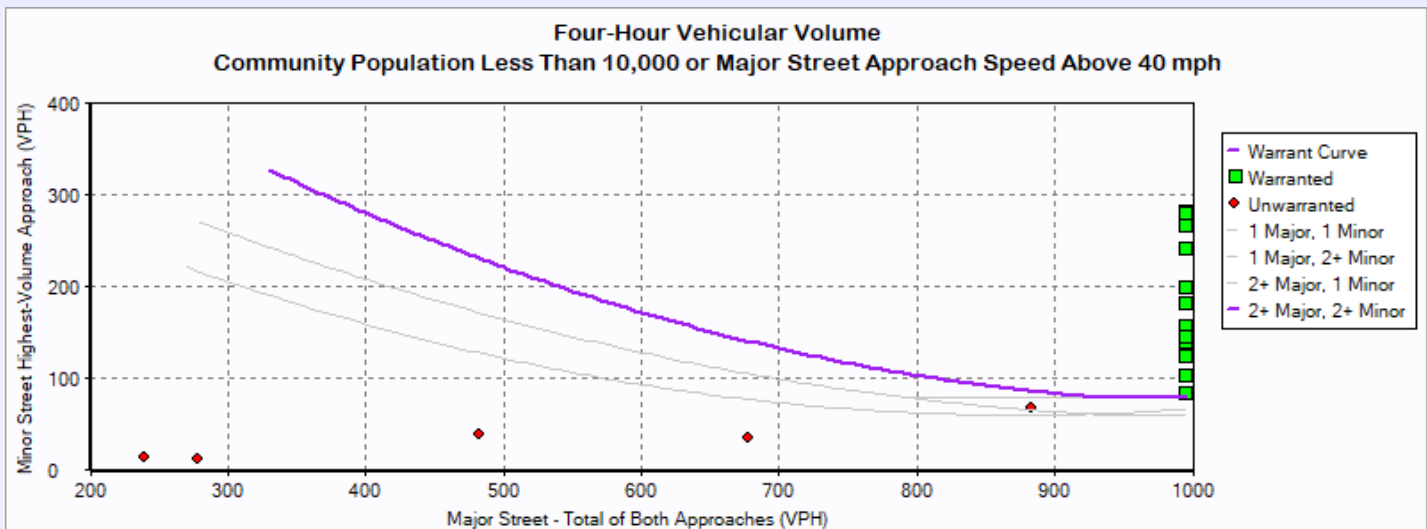
Intersection Information

	Major Street	Minor Street
Street Name	Scottsdale Road	Tierra Buena Lane
Direction	NB/SB	EB/WB
Number of Lanes	2	2
Approach Speed	45	30

Warrant 2 Met? **Yes**

Details:

Notes	15 Hours met (4 required)
Low population	No



Hourly Volumes

Hour	Major Street Total All Approaches (vph)	Minor Street Highest Volume Approach (vph)
00:00:00 - 01:00:00	166.00	13.00
01:00:00 - 02:00:00	100.00	11.00
02:00:00 - 03:00:00	61.00	1.00
03:00:00 - 04:00:00	78.00	5.00
04:00:00 - 05:00:00	240.00	15.00
05:00:00 - 06:00:00	678.00	35.00
06:00:00 - 07:00:00	1,163.00	102.00
07:00:00 - 08:00:00	2,155.00	282.00
08:00:00 - 09:00:00	2,461.00	181.00
09:00:00 - 10:00:00	2,408.00	145.00
10:00:00 - 11:00:00	2,603.00	139.00
11:00:00 - 12:00:00	3,034.00	199.00
12:00:00 - 13:00:00	3,172.00	242.00
13:00:00 - 14:00:00	3,077.00	152.00
14:00:00 - 15:00:00	2,948.00	156.00
15:00:00 - 16:00:00	3,107.00	267.00
16:00:00 - 17:00:00	3,051.00	279.00
17:00:00 - 18:00:00	3,055.00	279.00
18:00:00 - 19:00:00	2,294.00	145.00
19:00:00 - 20:00:00	1,853.00	124.00
20:00:00 - 21:00:00	1,404.00	83.00
21:00:00 - 22:00:00	883.00	68.00
22:00:00 - 23:00:00	482.00	40.00
23:00:00 - 00:00:00	278.00	12.00

Warranted Volumes

Hour	Major Street Total All Approaches (vph)	Minor Street Highest Volume Approach (vph)
06:00:00 - 07:00:00	1,163.00	102.00
07:00:00 - 08:00:00	2,155.00	282.00
08:00:00 - 09:00:00	2,461.00	181.00
09:00:00 - 10:00:00	2,408.00	145.00
10:00:00 - 11:00:00	2,603.00	139.00
11:00:00 - 12:00:00	3,034.00	199.00
12:00:00 - 13:00:00	3,172.00	242.00
13:00:00 - 14:00:00	3,077.00	152.00
14:00:00 - 15:00:00	2,948.00	156.00
15:00:00 - 16:00:00	3,107.00	267.00
16:00:00 - 17:00:00	3,051.00	279.00
17:00:00 - 18:00:00	3,055.00	279.00
18:00:00 - 19:00:00	2,294.00	145.00
19:00:00 - 20:00:00	1,853.00	124.00
20:00:00 - 21:00:00	1,404.00	83.00

Warrant 3: Peak Hour

1: Scottsdale Road & Tierra Buena Lane (4)

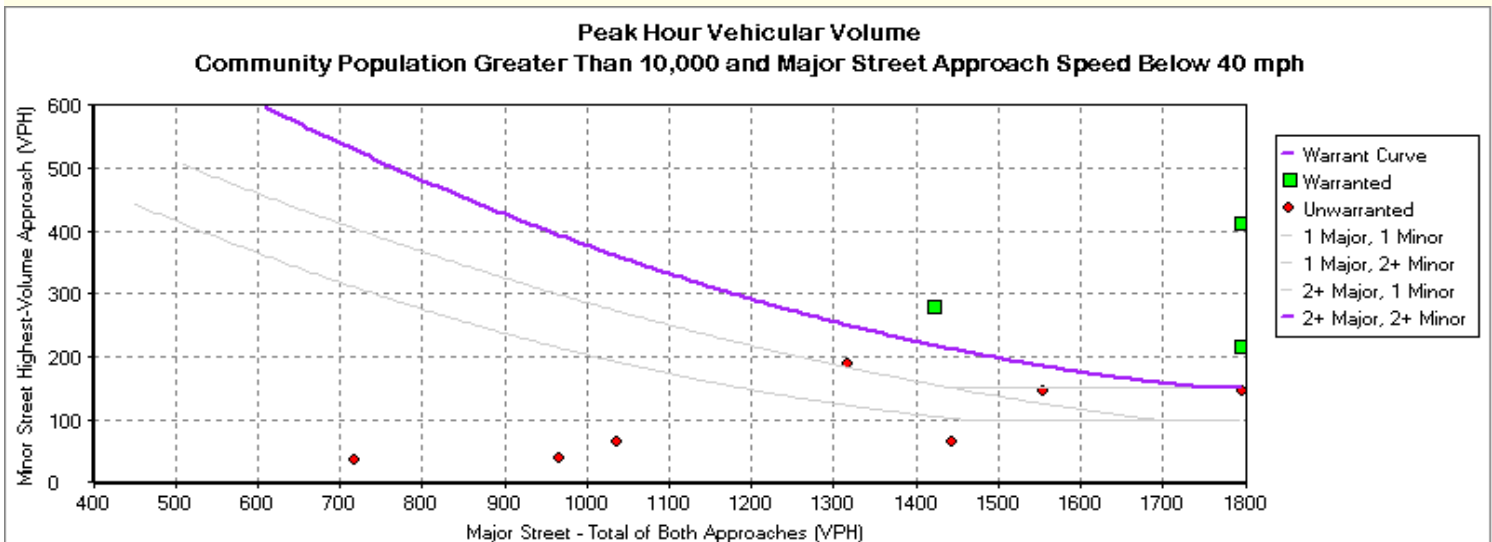
Intersection Information

	Major Street	Minor Street
Street Name	Scottsdale Road	Tierra Buena Lane
Direction	NB/SB	EB/WB
Number of Lanes	2	2
Approach Speed	45	30

Warrant 3 Met? **Yes**

Details

Low Population?	No		
Condition A Met?	No	Condition B Met?	Yes
Notes	0 Hours met (1 required)	Notes	14 Hours met (1 required)
Minor Approach Time Delay Condition Met?	Not Met		
Minor Approach Volume Condition Met?	Met		
Total Entering Intersection Volume Condition Met?	Not Met		



Hour	Major Street Total All Approaches (vph)	Minor Street Highest Volume Approach (vph)
0:00	166	13
1:00	100	11
2:00	61	1
3:00	78	5
4:00	240	15
5:00	678	35
6:00	1,163	102
7:00	2,155	282
8:00	2,461	181
9:00	2,408	145
10:00	2,603	139
11:00	3,034	199
12:00	3,172	242
13:00	3,077	152
14:00	2,948	156
15:00	3,107	267
16:00	3,051	279
17:00	3,055	279
18:00	2,294	145
19:00	1,853	124
20:00	1,404	83
21:00	883	68
22:00	482	40
23:00	278	12

Warrant 4: Pedestrian Volume

1: Scottsdale Road & Tierra Buena Lane (4)

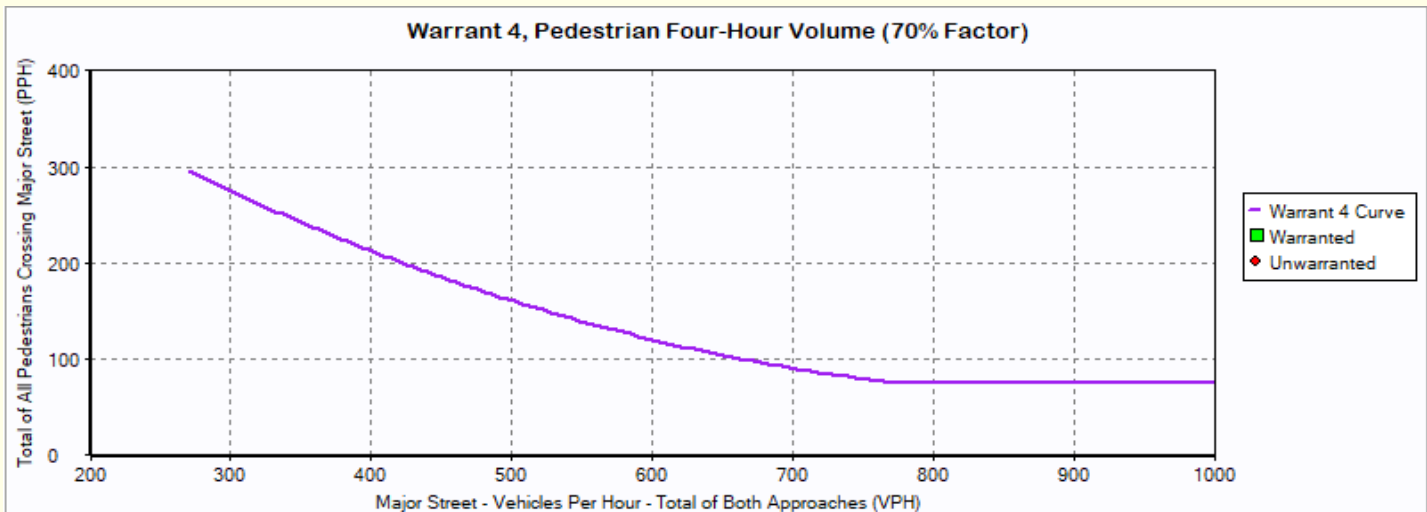
Intersection Information

	Major Street	Minor Street
Street Name	Scottsdale Road	Tierra Buena Lane
Direction	NB/SB	EB/WB
Number of Lanes	2	2
Approach Speed	45	30

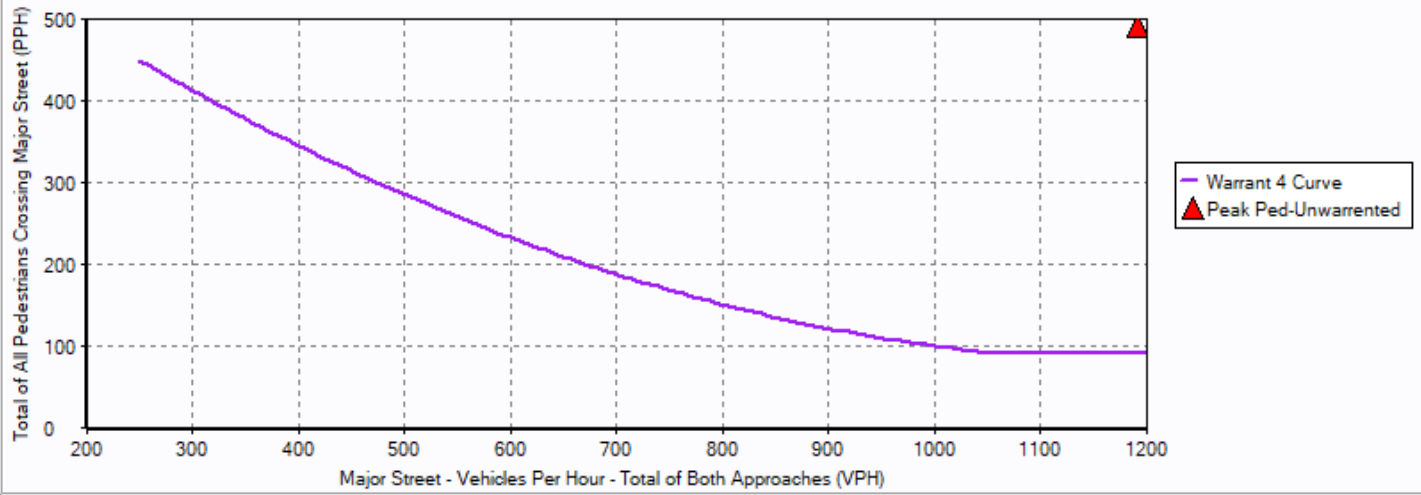
WARRANT 4 MET ? No

Details

Pedestrian Four Hour Volume Warrant Met?	No		
Pedestrian Peak Hour Warrant Met?	No	Notes	0 Hours met (4 required)
Speed Limit or 85th Percentile Speed on Major Street > 35mph, or Intersection lies within an Isolated Community with Population < 10,000?			Yes



Warrant 4, Pedestrian Peak Hour (70% Factor)



Warrant 5: School Crossing

1: Scottsdale Road & Tierra

Intersection Information

Major Street Name Scottsdale Road

Major Street Direction NB/SB

WARRANT 5 MET? **No**

Details:

Time Period Interval for Students Crossing (min) 0

Number of Students Crossing in Time Period 0

Number of Adequate Gaps in Time Period 0

Other Remedial Measures Attempted? **No**

Adjacent Signal on NB approach? **No**

Distance to signal on NB Approach (ft) -

Adjacent Signal on SB approach? **No**

Distance to signal on SB Approach (ft) -

Will New Signal Restrict Progressive Traffic? **No**

Warrant 6: Coordinated Signal System

1: Scottsdale Road & Tierra Buena Lane (4)

Intersection Information

Major Street Name Scottsdale Road

Major Street Direction NB/SB

WARRANT 6 MET? **No**

Details:

Approach Direction & Name	Acceptable Platooning?	Adjacent Coordinating Signal?	Adjacent Intersection Distance
SB Approach (Scottsdale Road)	Yes	No	N/A
NB Approach (Scottsdale Road)	Yes	No	N/A
WB Approach (Tierra Buena Lane)	Yes	No	N/A
EB Approach (Tierra Buena Lane)	Yes	No	N/A

Unacceptable Platooning?
(At least one approach)

No

Distance to Closest Signal
(Must be N/A or > 1000)

N/A

Warrant 7: Crash Experience

1: Scottsdale Road & Tierra Buena Lane (4)

Intersection Information

Major Street Name Scottsdale Road
 Major Street Direction NB/SB
 Minor Street Direction EB/WB

WARRANT 7 MET? **No**

Details:

Low Population?	No	Traffic Volume Condition Met?	Yes
Major Street Speed Limit	45		16 Hours Met (8 Required)
Major Street 85th-% tile Speed	0.00	Ped Volume Condition Met?	No
			0 Hours Met (8 Required)
	Qualifying Crashes	0	
	Adequate Alternative Trials?	No	

Hour	Traffic Volumes				Pedestrian Volumes			
	Major Street Vehicles	Minor Street Vehicles	80% Standard Met? A or B		Eastbound Ped Volumes		Westbound Ped Volumes	
			Condition A	Condition B	Peds	> 80?	Peds	> 80?
00:00 to 01:00	166	0	No	No	0	No	0	No
01:00 to 02:00	100	0	No	No	0	No	0	No
02:00 to 03:00	61	0	No	No	0	No	0	No
03:00 to 04:00	78	0	No	No	0	No	0	No
04:00 to 05:00	240	0	No	No	0	No	0	No
05:00 to 06:00	678	0	No	No	0	No	0	No
06:00 to 07:00	1,163	0	No	No	0	No	0	No

07:00 to 08:00	2,155	0	No	No	0	No	0	No
08:00 to 09:00	2,461	0	No	No	0	No	0	No
09:00 to 10:00	2,408	0	No	No	0	No	0	No
10:00 to 11:00	2,603	0	No	No	0	No	0	No
11:00 to 12:00	3,034	0	No	No	0	No	0	No
12:00 to 13:00	3,172	0	No	No	0	No	0	No
13:00 to 14:00	3,077	0	No	No	0	No	0	No
14:00 to 15:00	2,948	0	No	No	0	No	0	No
15:00 to 16:00	3,107	0	No	No	0	No	0	No
16:00 to 17:00	3,051	0	No	No	0	No	0	No
17:00 to 18:00	3,055	0	No	No	0	No	0	No
18:00 to 19:00	2,294	0	No	No	0	No	0	No
19:00 to 20:00	1,853	0	No	No	0	No	0	No
20:00 to 21:00	1,404	0	No	No	0	No	0	No
21:00 to 22:00	883	0	No	No	0	No	0	No
22:00 to 23:00	482	0	No	No	0	No	0	No
23:00 to 00:00	278	0	No	No	0	No	0	No

Warrant 8: Roadway Network

1: Scottsdale Road & Tierra Buena Lane (4)

Intersection Information

Major Street Name	Scottsdale Road
Major Street Direction	NB/SB
Minor Street Direction	EB/WB

WARRANT 8 MET? (A or B) Yes

Details:

	Growth Rates % (per year)			
	NB	SB	EB	WB
L	0.00	0.00	0.00	0.00
T	0.00	0.00	0.00	0.00
R	0.00	0.00	0.00	0.00

<u>Condition A, Total Entering Volume</u>		<u>Condition B, Non-normal Business Day</u>		
			<u>Existing</u>	<u>Future</u>
Existing Peak Hour	3,452	Highest Hour	0	0
Years	0.00	Second Highest Hour	0	0
Future Peak Hour	3,452	Third Highest Hour	0	0
Warrant 1 in 5 Years?	Yes	Fourth Highest Hour	0	0
Warrant 2 in 5 Years?	Yes	Fifth Highest Hour	0	0
Warrant 3 in 5 Years?	Yes	Yearly Growth Rate (%)	0.00	
		Years	0.00	

Condition A Met? Yes

Condition B Met? No

Warrant 9: Intersection Near a Grade Crossing

1: Scottsdale Road & Tierra Buena Lane (4)

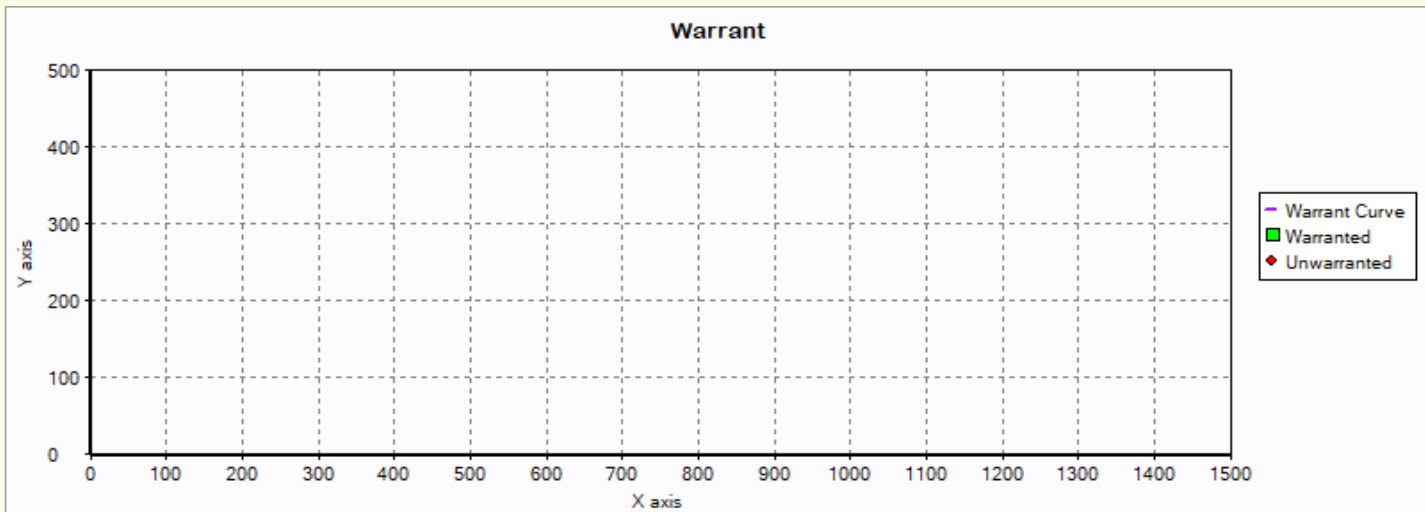
Intersection Information

	Major Street	Minor Street
Street Name	Scottsdale Road	Tierra Buena Lane
Direction	NB/SB	EB/WB
Number of Lanes	2	2
Approach Speed	45	30

WARRANT 9 MET ? **No**

Details

Note	No approach with a railroad grade crossing	
Minor street approach having a grade crossing		
Distance from the center of the track to the stop or yield line	Interpolated	
Number of occurrences of rail traffic per day		Adjustment Factor
Percentage of high-occupancy buses crossing the track (%)		Adjustment Factor
Percentage of tractor-trailer trucks crossing the track (%)		Adjustment Factor
The rail traffic arrival times are unknown, the highest traffic volume hour of the day is used		



Hour	Major Street Total of Both Approaches (vph)	Minor Street Adjusted Volume Crossing Tracks (vph)

All-Way Stop Control Warrant: Multiway Stop Applications

1: Scottsdale Road & Tierra Buena Lane (4)

Intersection Information

Major Street Name: Scottsdale Road

Major Street Direction: NB/SB

Minor Street Direction: EB/WB

AWSC WARRANT MET? Yes

Details:

Condition A Met?	Yes	Qualifying Crashes	0
Condition B Met?	No	Major Street 85th %-tile Speed	0.00
Condition C Met?	No	Major Street Speed Limit	45

Notes: Delay for highest hour < 30 sec/veh

Hour	Traffic Volumes		Bicycle Volumes		Ped Volumes		Condition C		
	Major Street	Minor Street	North Bound Bicycle Volumes	East Bound Bicycle Volumes	North Bound Ped Volumes	East Bound Ped Volumes	Major Street Veh Volume > 300	Minor Street Avg(Veh + Ped + Bicycle) > 200	Delay > 30
07:00 to 08:00	2,155	319	0	0	0	0	False	No	No
08:00 to 09:00	2,461	211	0	0	0	0	False	No	No
11:00 to 12:00	3,034	268	0	0	0	0	False	No	No
12:00 to 13:00	3,172	280	0	0	0	0	False	No	No
14:00 to 15:00	2,948	207	0	0	0	0	False	No	No
15:00 to 16:00	3,107	337	0	0	0	0	False	No	No
16:00 to 17:00	3,051	333	0	0	0	0	False	No	No
17:00 to 18:00	3,055	302	0	0	0	0	False	No	No

Warrant 6, Coordinated Signal System

No

Warrant 7, Crash Experience

No

Traffic Volume Condi **Yes** 10 Hours met (8 required)

Ped Condition? **No** 0 Hours met (8 required)

Warrant 8, Roadway Network

No

Warrant 9, Intersection Near a Grade Crossing

No

AWSC Warrant, Multiway Stop Application

No

Condition A Met? **No**

Condition B Met? **No**

Condition C Met? **No**

Warrant 1: Eight-hour Vehicular Volume

1: Greenway Hayden Loop & Paradise Lane

Intersection Information

Major Street Name: Greenway Hayden Loop

Major Street Direction: NB/SB

Minor Street Direction: EB/WB

WARRANT 1 MET? No

Details:

Condition A Met? No 1 Hours met (8 required)

Condition B Met? No 0 Hours met (8 required)

Hour	Major Street Vehicles (Total of Both Approaches)	High Volume Minor Approach Vehicles	100% Standard Met? Cond. A OR Cond. B		80% Standard Met? Cond. A AND Cond. B	
			Condition A 100% Column	Condition B 100% Column	Condition A 80% Column	Condition B 80% Column
00:00 to 01:00	79	1	No	No	No	No
Condition A	Volume >= 100% column (600)?	No	Volume >= 100% column (900)?	No		
	Volume >= 80% column (480)?	No	Volume >= 80% column (720)?	No		
Condition B	Volume >= 100% column (900)?	No	Volume >= 100% column (100)?	No		
	Volume >= 80% column (720)?	No	Volume >= 80% column (80)?	No		
01:00 to 02:00	31	5	No	No	No	No
Condition A	Volume >= 100% column (600)?	No	Volume >= 100% column (900)?	No		
	Volume >= 80% column (480)?	No	Volume >= 80% column (720)?	No		
Condition B	Volume >= 100% column (900)?	No	Volume >= 100% column (100)?	No		
	Volume >= 80% column (720)?	No	Volume >= 80% column (80)?	No		
02:00 to 03:00	15	1	No	No	No	No
Condition A	Volume >= 100% column (600)?	No	Volume >= 100% column (900)?	No		
	Volume >= 80% column (480)?	No	Volume >= 80% column (720)?	No		
Condition B	Volume >= 100% column (900)?	No	Volume >= 100% column (100)?	No		
	Volume >= 80% column (720)?	No	Volume >= 80% column (80)?	No		
03:00 to 04:00	39	3	No	No	No	No
Condition A	Volume >= 100% column (600)?	No	Volume >= 100% column (900)?	No		
	Volume >= 80% column (480)?	No	Volume >= 80% column (720)?	No		
Condition B	Volume >= 100% column (900)?	No	Volume >= 100% column (100)?	No		
	Volume >= 80% column (720)?	No	Volume >= 80% column (80)?	No		

04:00 to 05:00	96	3	No	No	No	No
Condition A	Volume >= 100% column (600)?	No	Volume >= 100% column (900)?	No		
	Volume >= 80% column (480)?	No	Volume >= 80% column (720)?	No		
Condition B	Volume >= 100% column (900)?	No	Volume >= 100% column (100)?	No		
	Volume >= 80% column (720)?	No	Volume >= 80% column (80)?	No		

05:00 to 06:00	344	15	No	No	No	No
Condition A	Volume >= 100% column (600)?	No	Volume >= 100% column (900)?	No		
	Volume >= 80% column (480)?	No	Volume >= 80% column (720)?	No		
Condition B	Volume >= 100% column (900)?	No	Volume >= 100% column (100)?	No		
	Volume >= 80% column (720)?	No	Volume >= 80% column (80)?	No		

06:00 to 07:00	638	36	No	No	No	No
Condition A	Volume >= 100% column (600)?	Yes	Volume >= 100% column (900)?	No		
	Volume >= 80% column (480)?	Yes	Volume >= 80% column (720)?	No		
Condition B	Volume >= 100% column (900)?	No	Volume >= 100% column (100)?	No		
	Volume >= 80% column (720)?	No	Volume >= 80% column (80)?	No		

07:00 to 08:00	1,587	81	No	No	No	Yes
Condition A	Volume >= 100% column (600)?	Yes	Volume >= 100% column (900)?	No		
	Volume >= 80% column (480)?	Yes	Volume >= 80% column (720)?	No		
Condition B	Volume >= 100% column (900)?	Yes	Volume >= 100% column (100)?	No		
	Volume >= 80% column (720)?	Yes	Volume >= 80% column (80)?	Yes		

08:00 to 09:00	1,883	82	No	No	No	Yes
Condition A	Volume >= 100% column (600)?	Yes	Volume >= 100% column (900)?	No		
	Volume >= 80% column (480)?	Yes	Volume >= 80% column (720)?	No		
Condition B	Volume >= 100% column (900)?	Yes	Volume >= 100% column (100)?	No		
	Volume >= 80% column (720)?	Yes	Volume >= 80% column (80)?	Yes		

09:00 to 10:00	1,692	74	No	No	No	No
Condition A	Volume >= 100% column (600)?	Yes	Volume >= 100% column (900)?	No		
	Volume >= 80% column (480)?	Yes	Volume >= 80% column (720)?	No		
Condition B	Volume >= 100% column (900)?	Yes	Volume >= 100% column (100)?	No		
	Volume >= 80% column (720)?	Yes	Volume >= 80% column (80)?	No		

10:00 to 11:00	1,605	89	No	No	No	Yes
Condition A	Volume >= 100% column (600)?	Yes	Volume >= 100% column (900)?	No		
	Volume >= 80% column (480)?	Yes	Volume >= 80% column (720)?	No		
Condition B	Volume >= 100% column (900)?	Yes	Volume >= 100% column (100)?	No		
	Volume >= 80% column (720)?	Yes	Volume >= 80% column (80)?	Yes		

11:00 to 12:00	1,999	93	No	No	No	Yes
Condition A	Volume >= 100% column (600)?	Yes	Volume >= 100% column (900)?	No		
	Volume >= 80% column (480)?	Yes	Volume >= 80% column (720)?	No		
Condition B	Volume >= 100% column (900)?	Yes	Volume >= 100% column (100)?	No		
	Volume >= 80% column (720)?	Yes	Volume >= 80% column (80)?	Yes		

12:00 to 13:00	1,934	101	No	Yes*	No	Yes
Condition A	Volume >= 100% column (600)?	Yes	Volume >= 100% column (900)?	No		
	Volume >= 80% column (480)?	Yes	Volume >= 80% column (720)?	No		
Condition B	Volume >= 100% column (900)?	Yes	Volume >= 100% column (100)?	Yes		
	Volume >= 80% column (720)?	Yes	Volume >= 80% column (80)?	Yes		

13:00 to 14:00	1,868	97	No	No	No	Yes
Condition A	Volume >= 100% column (600)?	Yes	Volume >= 100% column (900)?	No		
	Volume >= 80% column (480)?	Yes	Volume >= 80% column (720)?	No		
Condition B	Volume >= 100% column (900)?	Yes	Volume >= 100% column (100)?	No		
	Volume >= 80% column (720)?	Yes	Volume >= 80% column (80)?	Yes		

14:00 to 15:00	1,906	91	No	No	No	Yes
Condition A	Volume >= 100% column (600)?	Yes	Volume >= 100% column (900)?	No		
	Volume >= 80% column (480)?	Yes	Volume >= 80% column (720)?	No		
Condition B	Volume >= 100% column (900)?	Yes	Volume >= 100% column (100)?	No		
	Volume >= 80% column (720)?	Yes	Volume >= 80% column (80)?	Yes		

15:00 to 16:00	2,026	96	No	No	No	Yes
Condition A	Volume >= 100% column (600)?	Yes	Volume >= 100% column (900)?	No		
	Volume >= 80% column (480)?	Yes	Volume >= 80% column (720)?	No		
Condition B	Volume >= 100% column (900)?	Yes	Volume >= 100% column (100)?	No		
	Volume >= 80% column (720)?	Yes	Volume >= 80% column (80)?	Yes		

16:00 to 17:00	2,080	99	No	No	No	Yes
Condition A	Volume >= 100% column (600)?	Yes	Volume >= 100% column (900)?	No		
	Volume >= 80% column (480)?	Yes	Volume >= 80% column (720)?	No		
Condition B	Volume >= 100% column (900)?	Yes	Volume >= 100% column (100)?	No		
	Volume >= 80% column (720)?	Yes	Volume >= 80% column (80)?	Yes		

17:00 to 18:00	2,095	89	No	No	No	Yes
Condition A	Volume >= 100% column (600)?	Yes	Volume >= 100% column (900)?	No		
	Volume >= 80% column (480)?	Yes	Volume >= 80% column (720)?	No		
Condition B	Volume >= 100% column (900)?	Yes	Volume >= 100% column (100)?	No		
	Volume >= 80% column (720)?	Yes	Volume >= 80% column (80)?	Yes		

18:00 to 19:00	1,404	46	No	No	No	No
Condition A	Volume >= 100% column (600)?	Yes	Volume >= 100% column (900)?	No		
	Volume >= 80% column (480)?	Yes	Volume >= 80% column (720)?	No		
Condition B	Volume >= 100% column (900)?	Yes	Volume >= 100% column (100)?	No		
	Volume >= 80% column (720)?	Yes	Volume >= 80% column (80)?	No		

19:00 to 20:00	1,175	41	No	No	No	No
Condition A	Volume >= 100% column (600)?	Yes	Volume >= 100% column (900)?	No		
	Volume >= 80% column (480)?	Yes	Volume >= 80% column (720)?	No		
Condition B	Volume >= 100% column (900)?	Yes	Volume >= 100% column (100)?	No		
	Volume >= 80% column (720)?	Yes	Volume >= 80% column (80)?	No		

20:00 to 21:00	788	29	No	No	No	No
Condition A	Volume >= 100% column (600)?	Yes	Volume >= 100% column (900)?	No		
	Volume >= 80% column (480)?	Yes	Volume >= 80% column (720)?	No		
Condition B	Volume >= 100% column (900)?	No	Volume >= 100% column (100)?	No		
	Volume >= 80% column (720)?	Yes	Volume >= 80% column (80)?	No		

21:00 to 22:00	548	20	No	No	No	No
Condition A	Volume >= 100% column (600)?	No	Volume >= 100% column (900)?	No		
	Volume >= 80% column (480)?	Yes	Volume >= 80% column (720)?	No		
Condition B	Volume >= 100% column (900)?	No	Volume >= 100% column (100)?	No		
	Volume >= 80% column (720)?	No	Volume >= 80% column (80)?	No		

22:00 to 23:00	264		15	No	No	No	No
Condition A	Volume >= 100% column (600)?	No	Volume >= 100% column (900)?	No			
	Volume >= 80% column (480)?	No	Volume >= 80% column (720)?	No			
Condition B	Volume >= 100% column (900)?	No	Volume >= 100% column (100)?	No			
	Volume >= 80% column (720)?	No	Volume >= 80% column (80)?	No			

23:00 to 00:00	121		9	No	No	No	No
Condition A	Volume >= 100% column (600)?	No	Volume >= 100% column (900)?	No			
	Volume >= 80% column (480)?	No	Volume >= 80% column (720)?	No			
Condition B	Volume >= 100% column (900)?	No	Volume >= 100% column (100)?	No			
	Volume >= 80% column (720)?	No	Volume >= 80% column (80)?	No			

Warrant 2: Four-hour Vehicular Volume

1: Greenway Hayden Loop & Paradise Lane

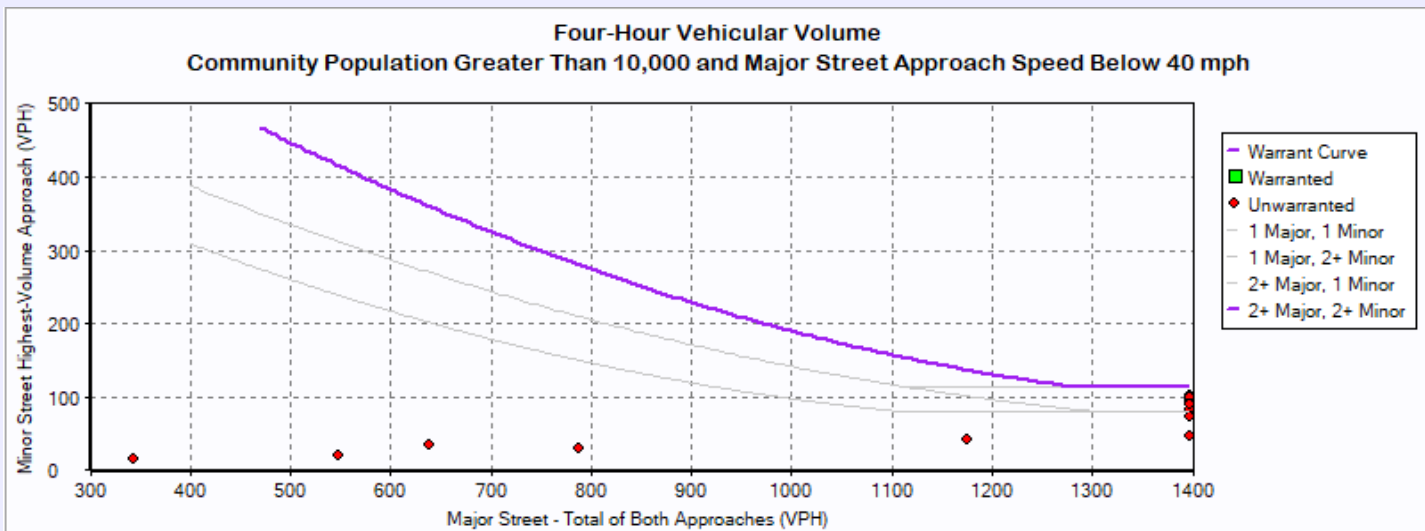
Intersection Information

	Major Street	Minor Street
Street Name	Greenway Hayden Loop	Paradise Lane
Direction	NB/SB	EB/WB
Number of Lanes	2	2
Approach Speed	40	30

Warrant 2 Met? **No**

Details:

Notes	0 Hours met (4 required)
Low population	No



Hourly Volumes

Hour	Major Street Total All Approaches (vph)	Minor Street Highest Volume Approach (vph)
00:00:00 - 01:00:00	79.00	1.00
01:00:00 - 02:00:00	31.00	5.00
02:00:00 - 03:00:00	15.00	1.00
03:00:00 - 04:00:00	39.00	3.00
04:00:00 - 05:00:00	96.00	3.00
05:00:00 - 06:00:00	344.00	15.00
06:00:00 - 07:00:00	638.00	36.00
07:00:00 - 08:00:00	1,587.00	81.00
08:00:00 - 09:00:00	1,883.00	82.00
09:00:00 - 10:00:00	1,692.00	74.00
10:00:00 - 11:00:00	1,605.00	89.00
11:00:00 - 12:00:00	1,999.00	93.00
12:00:00 - 13:00:00	1,934.00	101.00
13:00:00 - 14:00:00	1,868.00	97.00
14:00:00 - 15:00:00	1,906.00	91.00
15:00:00 - 16:00:00	2,026.00	96.00
16:00:00 - 17:00:00	2,080.00	99.00
17:00:00 - 18:00:00	2,095.00	89.00
18:00:00 - 19:00:00	1,404.00	46.00
19:00:00 - 20:00:00	1,175.00	41.00
20:00:00 - 21:00:00	788.00	29.00
21:00:00 - 22:00:00	548.00	20.00
22:00:00 - 23:00:00	264.00	15.00
23:00:00 - 00:00:00	121.00	9.00

Warranted Volumes

Hour	Major Street Total All Approaches (vph)	Minor Street Highest Volume Approach (vph)

Warrant 3: Peak Hour

1: Greenway Hayden Loop & Paradise Lane

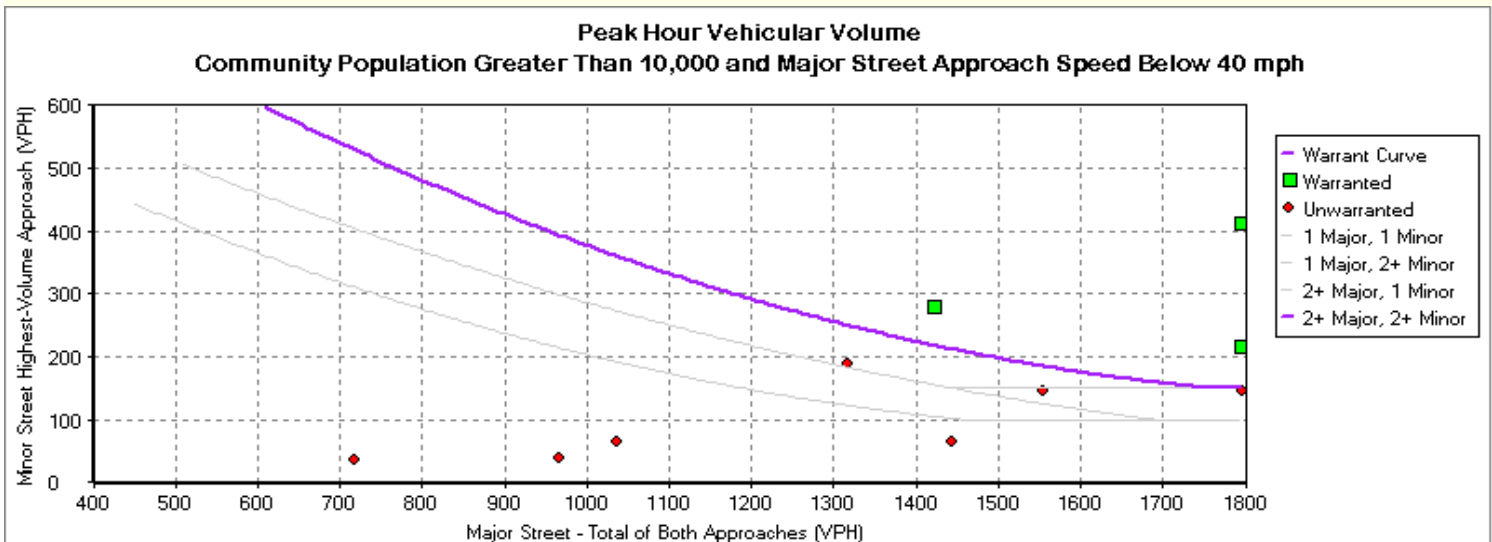
Intersection Information

	Major Street	Minor Street
Street Name	Greenway Hayden Loop	Paradise Lane
Direction	NB/SB	EB/WB
Number of Lanes	2	2
Approach Speed	40	30

Warrant 3 Met? **No**

Details

Low Population?	No		
Condition A Met?	No	Condition B Met?	No
Notes	0 Hours met (1 required)	Notes	0 Hours met (1 required)
Minor Approach Time Delay Condition Met?	Not Met		
Minor Approach Volume Condition Met?	Met		
Total Entering Intersection Volume Condition Met?	Not Met		



Hour	Major Street Total All Approaches (vph)	Minor Street Highest Volume Approach (vph)
0:00	79	1
1:00	31	5
2:00	15	1
3:00	39	3
4:00	96	3
5:00	344	15
6:00	638	36
7:00	1,587	81
8:00	1,883	82
9:00	1,692	74
10:00	1,605	89
11:00	1,999	93
12:00	1,934	101
13:00	1,868	97
14:00	1,906	91
15:00	2,026	96
16:00	2,080	99
17:00	2,095	89
18:00	1,404	46
19:00	1,175	41
20:00	788	29
21:00	548	20
22:00	264	15
23:00	121	9

Warrant 4: Pedestrian Volume

1: Greenway Hayden Loop & Paradise Lane

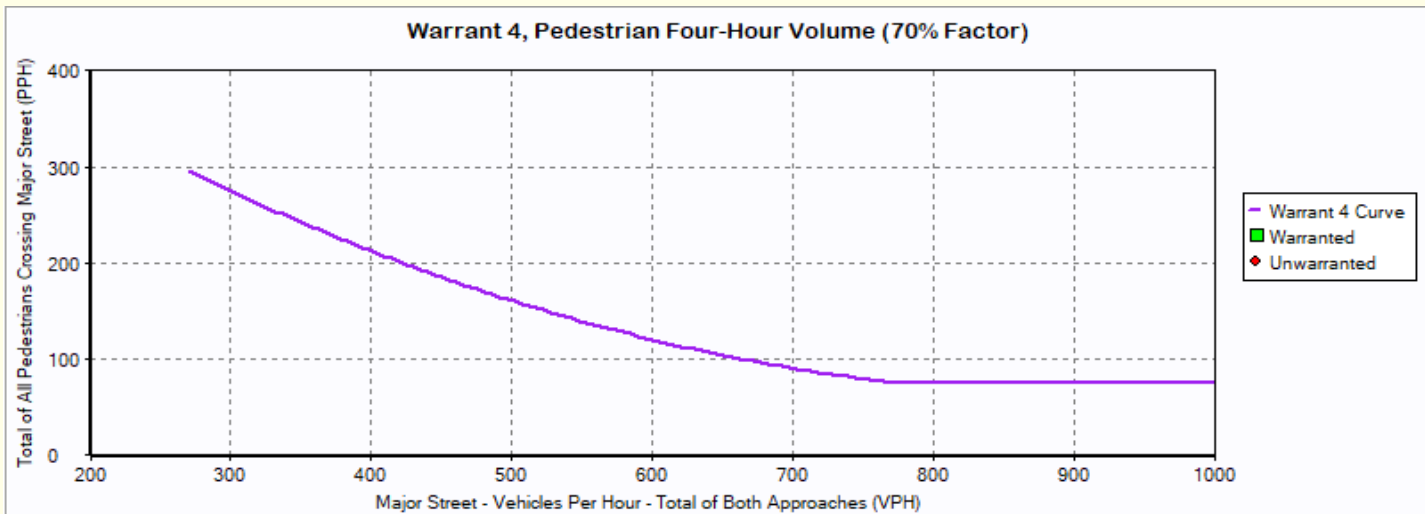
Intersection Information

	Major Street	Minor Street
Street Name	Greenway Hayden Loop	Paradise Lane
Direction	NB/SB	EB/WB
Number of Lanes	2	2
Approach Speed	40	30

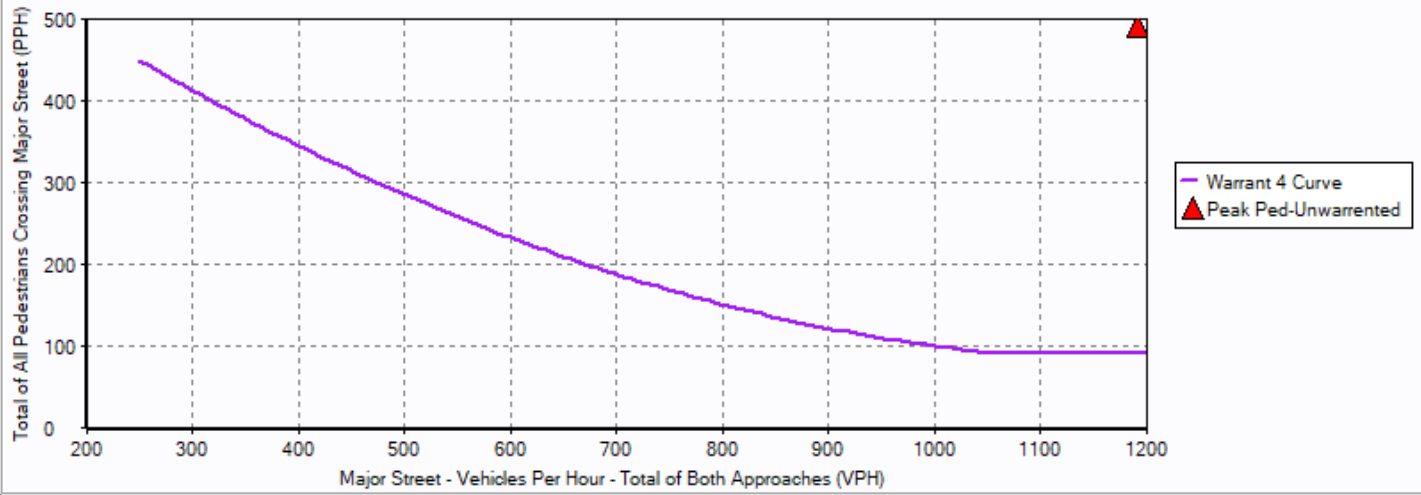
WARRANT 4 MET ? No

Details

Pedestrian Four Hour Volume Warrant Met?	No		
Pedestrian Peak Hour Warrant Met?	No	Notes	0 Hours met (4 required)
Speed Limit or 85th Percentile Speed on Major Street > 35mph, or Intersection lies within an Isolated Community with Population < 10,000?			Yes



Warrant 4, Pedestrian Peak Hour (70% Factor)



Warrant 5: School Crossing

1: Greenway Hayden Loop

Intersection Information

Major Street Name Greenway Hayden Loop

Major Street Direction NB/SB

WARRANT 5 MET? **No**

Details:

Time Period Interval for Students Crossing (min) 0

Number of Students Crossing in Time Period 0

Number of Adequate Gaps in Time Period 0

Other Remedial Measures Attempted? **No**

Adjacent Signal on NB approach? **No**

Distance to signal on NB Approach (ft) -

Adjacent Signal on SB approach? **No**

Distance to signal on SB Approach (ft) -

Will New Signal Restrict Progressive Traffic? **No**

Warrant 6: Coordinated Signal System

1: Greenway Hayden Loop & Paradise Lane

Intersection Information

Major Street Name Greenway Hayden Loop

Major Street Direction NB/SB

WARRANT 6 MET? **No**

Details:

Approach Direction & Name	Acceptable Platooning?	Adjacent Coordinating Signal?	Adjacent Intersection Distance
SB Approach (Greenway Hayden Loop)	Yes	No	N/A
NB Approach (Greenway Hayden Loop)	Yes	No	N/A
WB Approach (Paradise Lane)	Yes	No	N/A
EB Approach (Paradise Lane)	Yes	No	N/A

Unacceptable Platooning?
(At least one approach)

No

Distance to Closest Signal
(Must be N/A or > 1000)

N/A

Warrant 7: Crash Experience

1: Greenway Hayden Loop & Paradise Lane

Intersection Information

Major Street Name Greenway Hayden Loop
 Major Street Direction NB/SB
 Minor Street Direction EB/WB

WARRANT 7 MET? No

Details:

Low Population? **No** Traffic Volume Condition Met? **Yes**
 Major Street Speed Limit 40 10 Hours Met (8 Required)
 Major Street 85th-% tile Speed 0.00 Ped Volume Condition Met? **No**
 0 Hours Met (8 Required)
 Qualifying Crashes **0**
 Adequate Alternative Trials? **No**

Hour	Traffic Volumes				Pedestrian Volumes			
	Major Street Vehicles	Minor Street Vehicles	80% Standard Met? A or B		Eastbound Ped Volumes		Westbound Ped Volumes	
			Condition A	Condition B	Peds	> 80?	Peds	> 80?
00:00 to 01:00	79	0	No	No	0	No	0	No
01:00 to 02:00	31	0	No	No	0	No	0	No
02:00 to 03:00	15	0	No	No	0	No	0	No
03:00 to 04:00	39	0	No	No	0	No	0	No
04:00 to 05:00	96	0	No	No	0	No	0	No
05:00 to 06:00	344	0	No	No	0	No	0	No
06:00 to 07:00	638	0	No	No	0	No	0	No

07:00 to 08:00	1,587	0	No	No	0	No	0	No
08:00 to 09:00	1,883	0	No	No	0	No	0	No
09:00 to 10:00	1,692	0	No	No	0	No	0	No
10:00 to 11:00	1,605	0	No	No	0	No	0	No
11:00 to 12:00	1,999	0	No	No	0	No	0	No
12:00 to 13:00	1,934	0	No	No	0	No	0	No
13:00 to 14:00	1,868	0	No	No	0	No	0	No
14:00 to 15:00	1,906	0	No	No	0	No	0	No
15:00 to 16:00	2,026	0	No	No	0	No	0	No
16:00 to 17:00	2,080	0	No	No	0	No	0	No
17:00 to 18:00	2,095	0	No	No	0	No	0	No
18:00 to 19:00	1,404	0	No	No	0	No	0	No
19:00 to 20:00	1,175	0	No	No	0	No	0	No
20:00 to 21:00	788	0	No	No	0	No	0	No
21:00 to 22:00	548	0	No	No	0	No	0	No
22:00 to 23:00	264	0	No	No	0	No	0	No
23:00 to 00:00	121	0	No	No	0	No	0	No

Warrant 8: Roadway Network

1: Greenway Hayden Loop & Paradise Lane

Intersection Information

Major Street Name	Greenway Hayden Loop
Major Street Direction	NB/SB
Minor Street Direction	EB/WB

WARRANT 8 MET? (A or B) No

Details:

	Growth Rates % (per year)			
	NB	SB	EB	WB
L	0.00	0.00	0.00	0.00
T	0.00	0.00	0.00	0.00
R	0.00	0.00	0.00	0.00

<u>Condition A, Total Entering Volume</u>		<u>Condition B, Non-normal Business Day</u>		
			<u>Existing</u>	<u>Future</u>
Existing Peak Hour	2,271	Highest Hour	0	0
Years	0.00	Second Highest Hour	0	0
Future Peak Hour	2,271	Third Highest Hour	0	0
Warrant 1 in 5 Years?	No	Fourth Highest Hour	0	0
Warrant 2 in 5 Years?	No	Fifth Highest Hour	0	0
Warrant 3 in 5 Years?	No	Yearly Growth Rate (%)	0.00	
		Years	0.00	

Condition A Met? No

Condition B Met? No

Warrant 9: Intersection Near a Grade Crossing

1: Greenway Hayden Loop & Paradise Lane

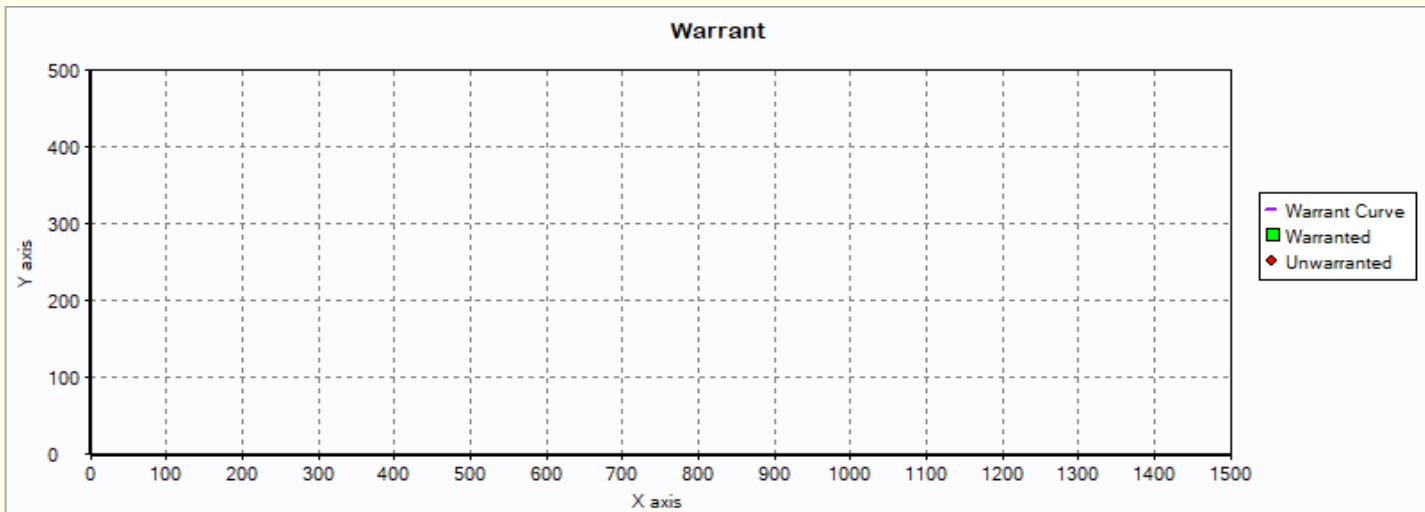
Intersection Information

	Major Street	Minor Street
Street Name	Greenway Hayden Loop	Paradise Lane
Direction	NB/SB	EB/WB
Number of Lanes	2	2
Approach Speed	40	30

WARRANT 9 MET ? No

Details

Note	No approach with a railroad grade crossing	
Minor street approach having a grade crossing		
Distance from the center of the track to the stop or yield line	Interpolated	
Number of occurrences of rail traffic per day		Adjustment Factor
Percentage of high-occupancy buses crossing the track (%)		Adjustment Factor
Percentage of tractor-trailer trucks crossing the track (%)		Adjustment Factor
The rail traffic arrival times are unknown, the highest traffic volume hour of the day is used		



Hour	Major Street Total of Both Approaches (vph)	Minor Street Adjusted Volume Crossing Tracks (vph)

All-Way Stop Control Warrant: Multiway Stop Applications

1: Greenway Hayden Loop & Paradise Lane

Intersection Information

Major Street Name: Greenway Hayden Loop
 Major Street Direction: NB/SB
 Minor Street Direction: EB/WB

AWSC WARRANT MET? No

Details:

Condition A Met?	No	Qualifying Crashes	0
Condition B Met?	No	Major Street 85th %-tile Speed	0.00
Condition C Met?	No	Major Street Speed Limit	40
Notes: 7 Hours Met (8 Required)			

Hour	Traffic Volumes		Bicycle Volumes		Ped Volumes		Condition C		
	Major Street	Minor Street	North Bound Bicycle Volumes	East Bound Bicycle Volumes	North Bound Ped Volumes	East Bound Ped Volumes	Major Street Veh Vol > 210	Minor Street Avg(Veh + Ped + Bicycle) > 200	Delay > 30
10:00 to 11:00	1,605	167	0	0	0	0	False	No	No
11:00 to 12:00	1,999	177	0	0	0	0	False	No	No
12:00 to 13:00	1,934	182	0	0	0	0	False	No	No
13:00 to 14:00	1,868	168	0	0	0	0	False	No	No
14:00 to 15:00	1,906	173	0	0	0	0	False	No	No
15:00 to 16:00	2,026	180	0	0	0	0	False	No	No
16:00 to 17:00	2,080	191	0	0	0	0	False	No	No



Appendix N – Dial Boulevard and Paradise Lane Alternative Analysis

Intersection	
Intersection Delay, s/veh	11.2
Intersection LOS	B

Movement	EBT	EBR	WBL	WBT	NBL	NBR
Lane Configurations						
Traffic Vol, veh/h	221	88	45	129	96	158
Future Vol, veh/h	221	88	45	129	96	158
Peak Hour Factor	0.92	0.92	0.92	0.92	0.92	0.92
Heavy Vehicles, %	2	2	2	2	2	2
Mvmt Flow	240	96	49	140	104	172
Number of Lanes	1	0	1	1	1	1

Approach	EB	WB	NB
Opposing Approach	WB	EB	
Opposing Lanes	2	1	0
Conflicting Approach Left		NB	EB
Conflicting Lanes Left	0	2	1
Conflicting Approach Right	NB		WB
Conflicting Lanes Right	2	0	2
HCM Control Delay	12.9	9.9	10
HCM LOS	B	A	A

Lane	NBLn1	NBLn2	EBLn1	WBLn1	WBLn2
Vol Left, %	100%	0%	0%	100%	0%
Vol Thru, %	0%	0%	72%	0%	100%
Vol Right, %	0%	100%	28%	0%	0%
Sign Control	Stop	Stop	Stop	Stop	Stop
Traffic Vol by Lane	96	158	309	45	129
LT Vol	96	0	0	45	0
Through Vol	0	0	221	0	129
RT Vol	0	158	88	0	0
Lane Flow Rate	104	172	336	49	140
Geometry Grp	7	7	4	7	7
Degree of Util (X)	0.184	0.245	0.478	0.083	0.219
Departure Headway (Hd)	6.347	5.136	5.126	6.118	5.612
Convergence, Y/N	Yes	Yes	Yes	Yes	Yes
Cap	560	692	699	580	634
Service Time	4.137	2.925	3.202	3.911	3.405
HCM Lane V/C Ratio	0.186	0.249	0.481	0.084	0.221
HCM Control Delay	10.6	9.6	12.9	9.5	10
HCM Lane LOS	B	A	B	A	A
HCM 95th-tile Q	0.7	1	2.6	0.3	0.8

Intersection	
Intersection Delay, s/veh	11.6
Intersection LOS	B

Movement	EBT	EBR	WBL	WBT	NBL	NBR
Lane Configurations	↻		↻	↻	↻	↻
Traffic Vol, veh/h	141	118	103	234	116	146
Future Vol, veh/h	141	118	103	234	116	146
Peak Hour Factor	0.92	0.92	0.92	0.92	0.92	0.92
Heavy Vehicles, %	2	2	2	2	2	2
Mvmt Flow	153	128	112	254	126	159
Number of Lanes	1	0	1	1	1	1

Approach	EB	WB	NB
Opposing Approach	WB	EB	
Opposing Lanes	2	1	0
Conflicting Approach Left		NB	EB
Conflicting Lanes Left	0	2	1
Conflicting Approach Right	NB		WB
Conflicting Lanes Right	2	0	2
HCM Control Delay	12.3	11.7	10.7
HCM LOS	B	B	B

Lane	NBLn1	NBLn2	EBLn1	WBLn1	WBLn2
Vol Left, %	100%	0%	0%	100%	0%
Vol Thru, %	0%	0%	54%	0%	100%
Vol Right, %	0%	100%	46%	0%	0%
Sign Control	Stop	Stop	Stop	Stop	Stop
Traffic Vol by Lane	116	146	259	103	234
LT Vol	116	0	0	103	0
Through Vol	0	0	141	0	234
RT Vol	0	146	118	0	0
Lane Flow Rate	126	159	282	112	254
Geometry Grp	7	7	4	7	7
Degree of Util (X)	0.236	0.244	0.422	0.194	0.405
Departure Headway (Hd)	6.74	5.525	5.394	6.235	5.729
Convergence, Y/N	Yes	Yes	Yes	Yes	Yes
Cap	533	651	667	577	628
Service Time	4.469	3.254	3.419	3.96	3.454
HCM Lane V/C Ratio	0.236	0.244	0.423	0.194	0.404
HCM Control Delay	11.5	10	12.3	10.5	12.3
HCM Lane LOS	B	A	B	B	B
HCM 95th-tile Q	0.9	1	2.1	0.7	2